

Connector set - HC-EVO-B06PT-BWSC-HL-M20-PLRBK - 1407710

Please be informed that the data shown in this PDF Document is generated from our Online Catalog. Please find the complete data in the user's documentation. Our General Terms of Use for Downloads are valid (<http://phoenixcontact.com/download>)



EVO connector set, B6 series, plastic housing, consisting of: 1407727, 1407728, 1407622, 1407619, 1407669, plastic housing

Your advantages

- Lower costs than metal version
- Labeling option using 9 x 20 mm marking label
- Low weight
- Lower risk of condensation
- Both contact insert PE sheets are connected by means of a metal frame integrated in the sleeve housing
- Metal inlays ensure leading PE contact with angled plugs
- Completely corrosion-resistant
- Halogen-free plastic
- Marking label can be attached



Key Commercial Data

Packing unit	1 pc
GTIN	
GTIN	4046356777759

Technical data

General

Number of positions	6+PE
Type	B6
Connection method	Push-in connection
Cable outlet	straight
	lateral
Degree of protection for housing	IP66
	12 (UL 50e)
Connection method	Push-in connection

Connector set - HC-EVO-B06PT-BWSC-HL-M20-PLRBK - 1407710

Technical data

General

Rated voltage (III/3)	500 V
Rated surge voltage	6 kV
Rated current	16 A
Conductor cross section	0.14 mm ² ... 2.5 mm ² (with ferrule)
Connection cross section AWG	26 ... 14 (with ferrule)
External cable diameter	7 mm ... 13 mm
Ambient temperature (operation)	-40 °C ... 100 °C
Length of the assembly cutout	52 mm
Width of the assembly cutout	35 mm
Housing material	PA
Contact carrier material	PC
Locking latch material	PA
Integrated protective cover	Yes

Standards and Regulations

Flammability rating according to UL 94	V0
--	----

Environmental Product Compliance

China RoHS	Environmentally Friendly Use Period = 50
	For details about hazardous substances go to tab "Downloads", Category "Manufacturer's declaration"

Drawings

Connector set - HC-EVO-B06PT-BWSC-HL-M20-PLRBK - 1407710

Schematic diagram

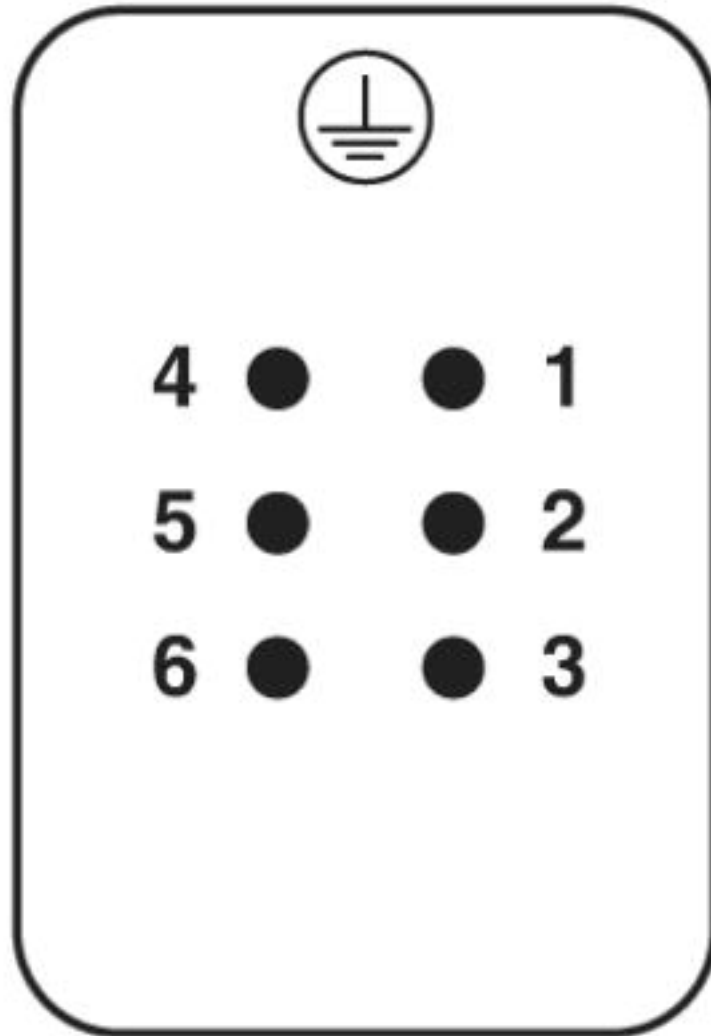

Pin assignment, connection side, pin

Connector set - HC-EVO-B06PT-BWSC-HL-M20-PLRBK - 1407710

Schematic diagram

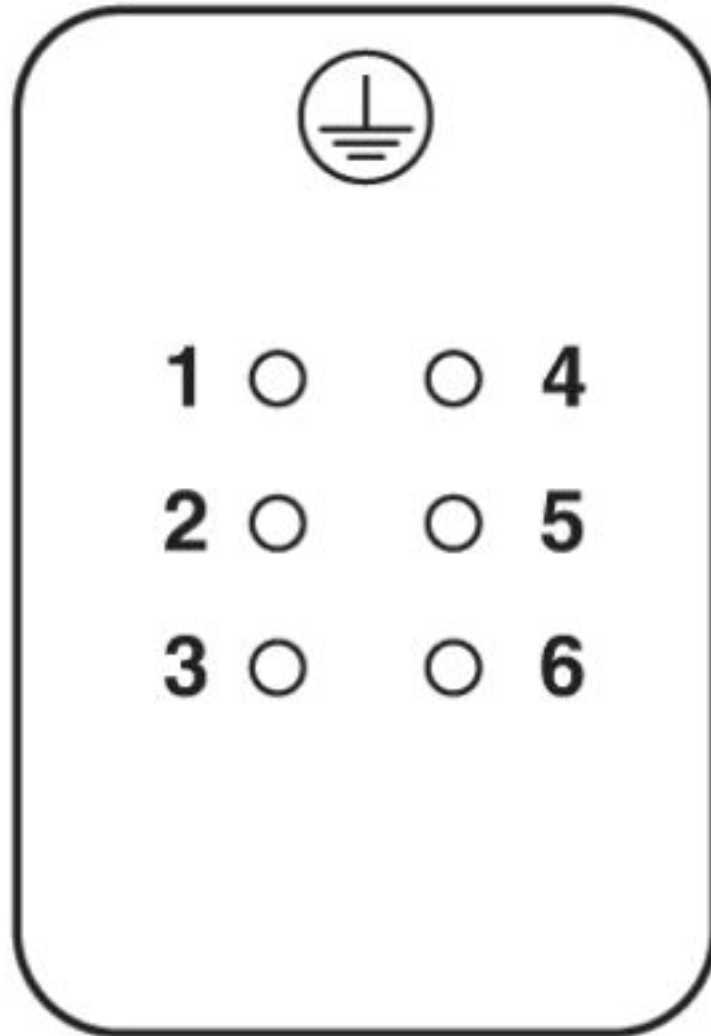

Pin assignment, connection side, socket

Connector set - HC-EVO-B06PT-BWSC-HL-M20-PLRBK - 1407710

Diagram

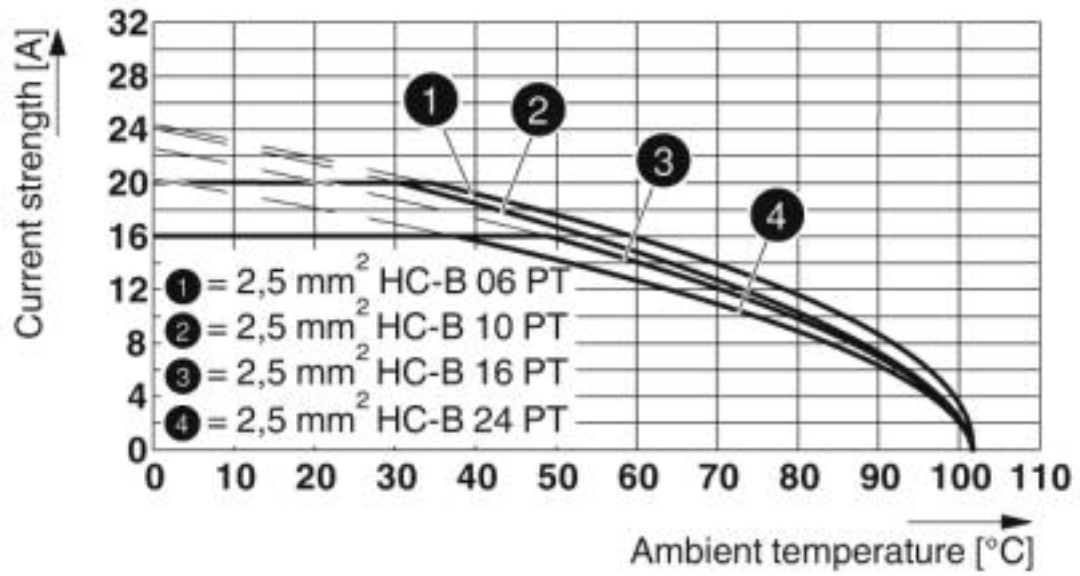

Derating diagram

Connector set - HC-EVO-B06PT-BWSC-HL-M20-PLRBK - 1407710

Dimensional drawing

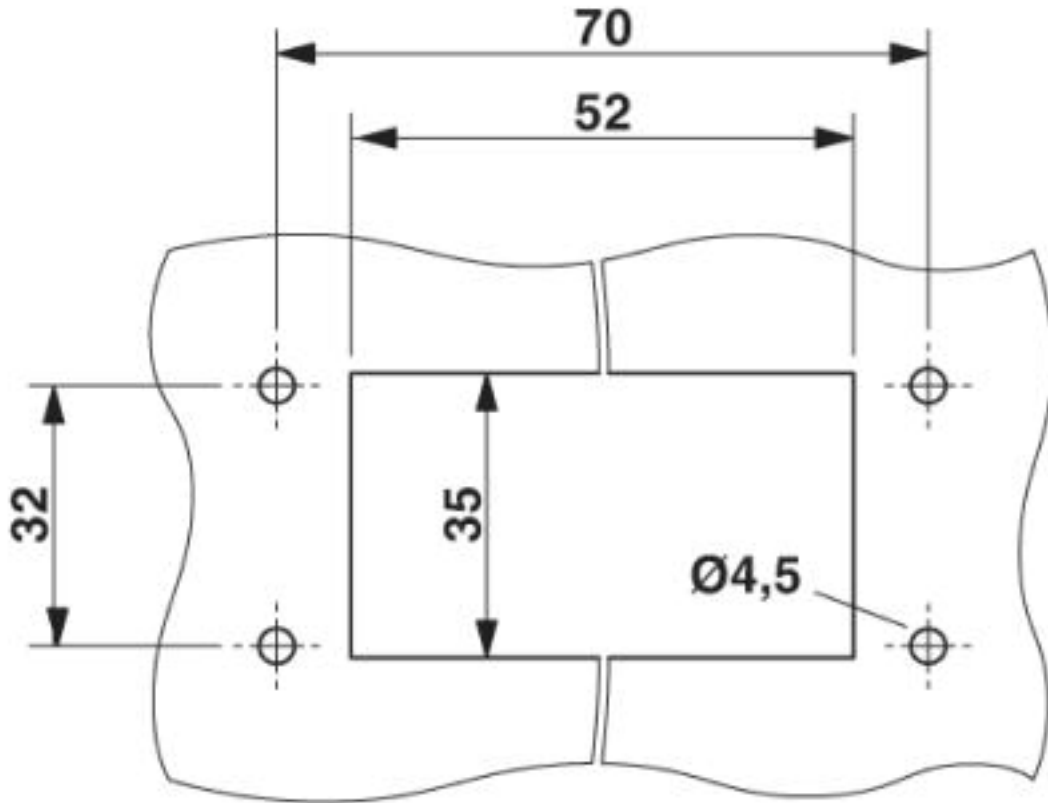

Mounting cutout

Dimensional drawing

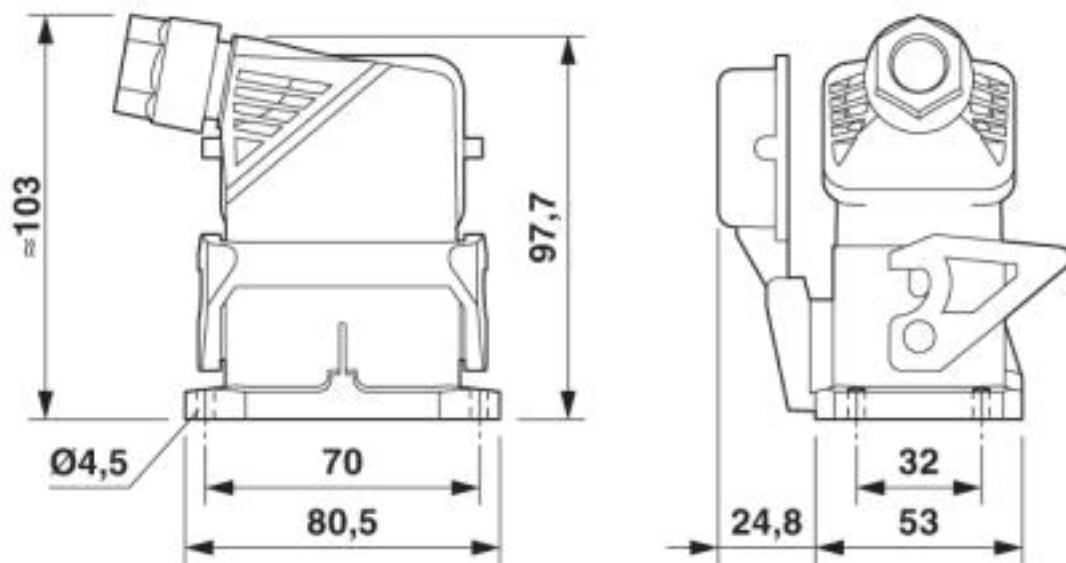

Dimensional drawing

Connector set - HC-EVO-B06PT-BWSC-HL-M20-PLRBK - 1407710

Articles in set

Contact insert - HC-B06-I-PT-F - 1407727



HEAVYCON socket insert, B6 series, 6 + PE-pos., push-in connection

Contact insert - HC-B06-I-PT-M - 1407728



HEAVYCON pin insert, B6 series, 6 + PE-pos., push-in connection

Housing - HC-EVO-B06-BWSC-PLRBK - 1407622



HEAVYCON EVO panel mounting base, plastic, B6, with single locking latch, height: 30.5 mm, with flat gasket, with protective cover

Housing - HC-EVO-B06-HLFS-PLBK - 1407619



HEAVYCON EVO sleeve housing, plastic, with bayonet flange for EVO screw connection, B6, for single locking latch, height: 60.5 mm, without EVO screw connection

Cable gland - HC-B-G-M20-PLRBK - 1407669



EVO plastic cable gland with bayonet locking, for housing series B, size M20, cable diameter: 7 ... 13 mm

Approvals

Approvals

Connector set - HC-EVO-B06PT-BWSC-HL-M20-PLRBK - 1407710



Approvals

Approvals

EAC / EAC / DNV GL

Ex Approvals

Approval details

EAC		RU C- DE.AI30.B.01102	
EAC		EAC-Zulassung	
DNV GL		https://approvalfinder.dnvgl.com/	TAE000037S

Phoenix Contact 2019 © - all rights reserved
<http://www.phoenixcontact.com>

PHOENIX CONTACT GmbH & Co. KG
Flachsmarktstr. 8
32825 Blomberg
Germany
Tel. +49 5235 300
Fax +49 5235 3 41200
<http://www.phoenixcontact.com>