

# Dual Port VDSL2 Line Driver

## ISL1539A

The ISL1539A provides 4 internal wideband op amps intended to be used as two pairs of differential line drivers. The ISL1539A's high bandwidth, 240MHz, and ultra low distortion, -89dBc @ 1MHz, 2V<sub>p-p</sub>, support the demanding MTPR requirements of emerging VDSL2 line driver designs. Less demanding requirements can be met at very low quiescent powers using the supply current adjustment features.

Each of the 4 internal op amps is a wideband current feedback amplifier offering very high slew rate intrinsic to that design using low quiescent current levels. Each of the two pair of amplifiers (ports) can also be power optimized to the application using two external quiescent control logic pins. Full power is nominally 27.2mA/port with options of medium power cutback to 23mA/port, a low power condition at 13.5mA/port, and an off state at <0.5mA/port. Added quiescent power flexibility is provided through an external I<sub>ADJ</sub> pin. Grounding the pin gives the nominal currents listed above while inserting a resistor from this pin to ground can be used to scale each of the settings downward.

High power push/pull line driver applications as illustrated in the example below are best supported using a low headroom, high output current device. On ±12V supplies, the ISL1539A offers a 1.1V headroom with >360mA peak output current. Driving differentially this gives >41.8V<sub>p-p</sub> swing to as low as 58Ω differential load. High SFDR operation is also supported for supplies as low as ±7.5V. Intended to be used as differential pairs, this two port device includes special circuitry to minimize common mode loop peaking while also reducing the common mode output noise spectrum. That circuitry links the two sides of each port, precluding their application as individual amplifiers.

## Features

- 360mA Output Drive Capability
- 41.8V<sub>p-p</sub> Differential Output Drive into 100Ω
- -89dBc THD @ 1MHz 2V<sub>p-p</sub>
- -65dBc MTPR (VDSL 8b Profile)
- High Slew Rate of 3000V/μs Differential
- Bandwidth (240MHz @ A<sub>V-DIFF</sub> = 10)
- Supply Current Control Pins
- Port Separation
  - 78dB @ 500kHz
  - 70dB @ 1MHz
  - 60dB @ 4MHz
- Pb-Free (RoHS Compliant)

## Applications\* (see page 21)

- 8MHz and 17MHz VDSL2 Profiles
- ADSL2+

## Related Literature (see Device Info page)

- AN1325 "Choosing and Using Bypass Capacitors"
- TB426 "Characterization of the Output Protection Circuitry of the EL1528 DSL Driver for Lightning Surges"

TABLE 1. ALTERNATE SOLUTIONS

PART #	NOMINAL ±V <sub>CC</sub> (V)	BANDWIDTH (MHz)	APPLICATIONS
ISL1557	±6	200	VDSL
ISL1534	±12	40	ADSL2+
ISL1536	±12	50	ADSL2+

## Typical Application

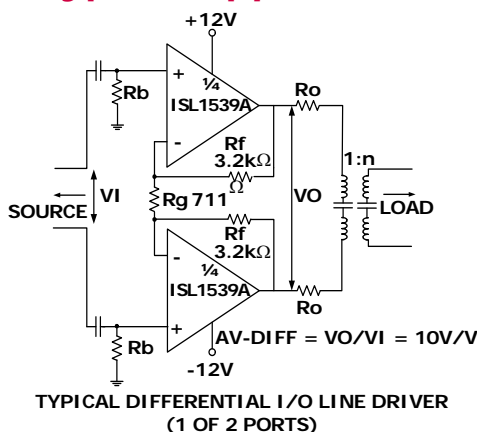

## 4MHz Harmonic Distortion

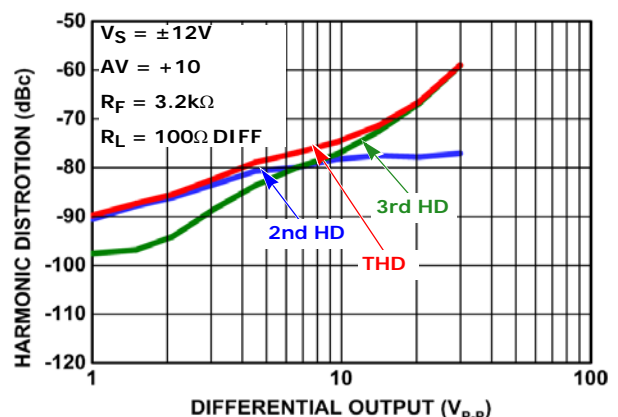

## Pin Configurations

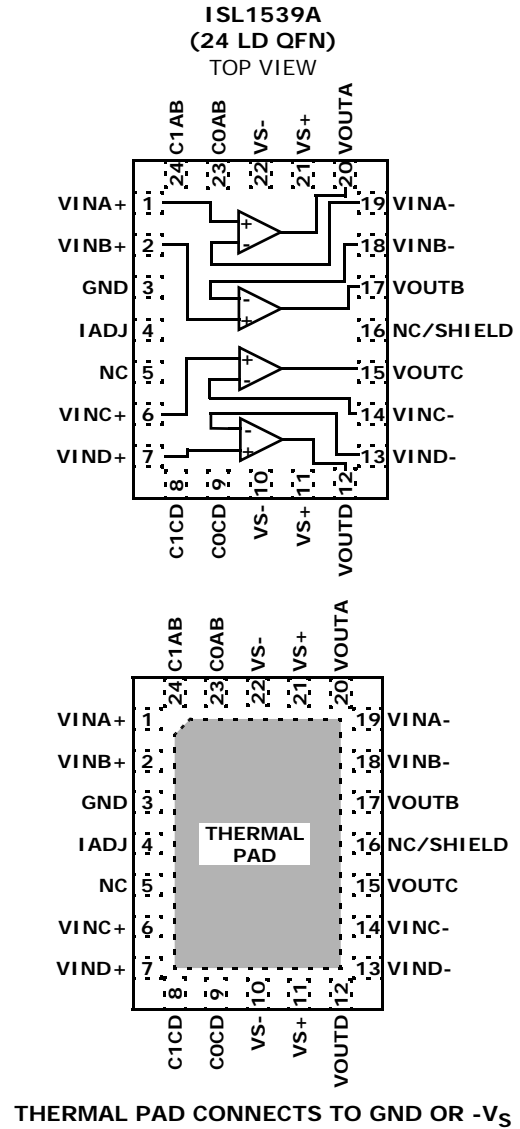
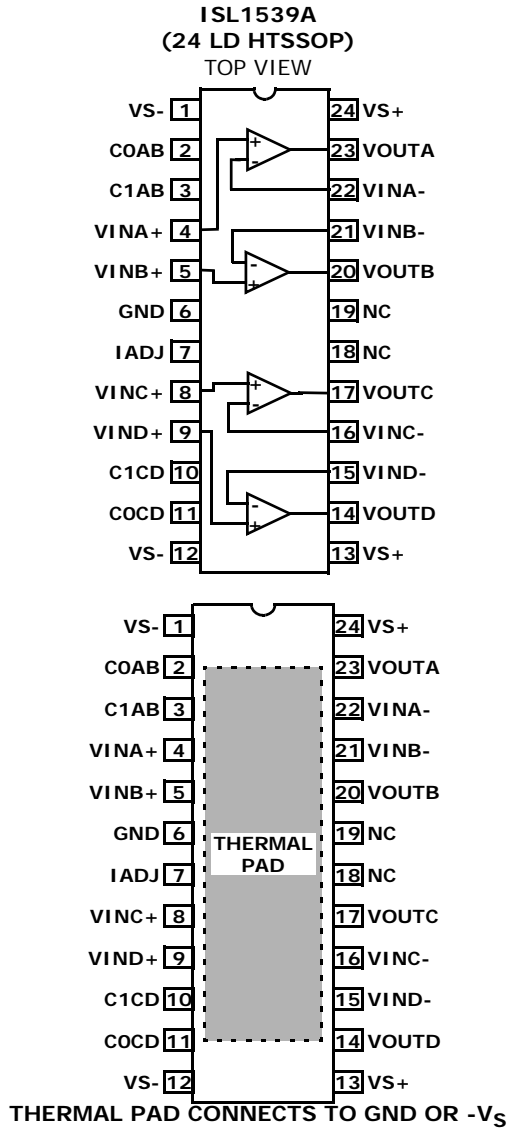

## Pin Descriptions

ISL1539AIR (24 Ld QFN)	ISL1539AIV (24 Ld HTSSOP)	PIN NAME	FUNCTION	CIRCUIT
1	4	VINA+	Amplifier A non-inverting input	(Refer to Circuit 1)
2	5	VINB+	Amplifier B non-inverting input	(Refer to Circuit 1)
3	6	GND	Ground connection	
4	7	IADJ	Supply current control pin for both DSL Port #1 and #2	(Refer to Figure 46)
5	18, 19	NC	Not connected	
6	8	VINC+	Amplifier C non-inverting input	(Refer to Circuit 1)
7	9	VIND+	Amplifier D non-inverting input	(Refer to Circuit 1)
8	10	C1CD	DSL Port #2 current control pin	(Refer to Figure 46)
9	11	COCD	DSL Port #2 current control pin	(Refer to Figure 46)
10, 22	1, 12	VS-	Negative supply	
11, 21	13, 24	VS+	Positive supply	
12	14	VOUTD	Amplifier D output	(Refer to Circuit 2)

# ISL1539A

## Pin Descriptions (Continued)

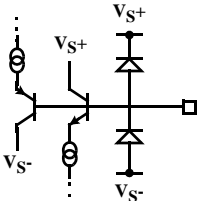
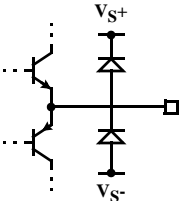
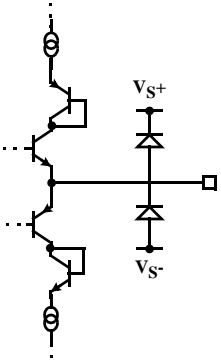
ISL1539AIR (24 Ld QFN)	ISL1539AIV (24 Ld HTSSOP)	PIN NAME	FUNCTION	CIRCUIT
13	15	VIND-	Amplifier D Inverting Input	(Refer to Circuit 3)
14	16	VINC-	Amplifier C Inverting Input	(Refer to Circuit 3)
15	17	VOUTC	Amplifier C output	(Refer to Circuit 2)
16	18, 19	NC/SHIELD	Not Connected	
17	20	VOUTB	Amplifier B output	(Refer to Circuit 2)
18	21	VINB-	Amplifier B Inverting Input	(Refer to Circuit 3)
19	22	VINA-	Amplifier A Inverting Input	(Refer to Circuit 3)
20	23	VOUTA	Amplifier A output	(Refer to Circuit 2)
23	2	COAB	DSL Port #1 current control pin	(Refer to Figure 46)
24	3	C1AB	DSL Port #1 current control pin	(Refer to Figure 46)
-	-	THERMAL PAD	Connects to GND or -V <sub>S</sub>	
		 <p>CIRCUIT 1</p>	 <p>CIRCUIT 2</p>	 <p>CIRCUIT 3</p>

## Ordering Information

PART NUMBER	PART MARKING	OPERATING AMBIENT TEMP RANGE (°C)	PACKAGE (Pb-free)	PKG. DWG. #
ISL1539AIRZ (Note 2)	1539A IRZ	-40 to +85	24 Ld QFN	L24.4x5B
ISL1539AIRZ-T13 (Notes 1, 2)	1539A IRZ	-40 to +85	24 Ld QFN	L24.4x5B
<b>COMING SOON</b> ISL1539AIVEZ (Note 2)	1539A IVEZ	-40 to +85	24 Ld HTSSOP	MDP0048
<b>COMING SOON</b> ISL1539AIVEZ-T13 (Notes 1, 2)	1539A IVEZ	-40 to +85	24 Ld HTSSOP	MDP0048

### NOTES:

1. Please refer to [TB347](#) for details on reel specifications.
2. These Intersil Pb-free plastic packaged products employ special Pb-free material sets, molding compounds/die attach materials, and 100% matte tin plate plus anneal (e3 termination finish, which is RoHS compliant and compatible with both SnPb and Pb-free soldering operations). Intersil Pb-free products are MSL classified at Pb-free peak reflow temperatures that meet or exceed the Pb-free requirements of IPC/JEDEC J STD-020.
3. For Moisture Sensitivity Level (MSL), please see device information page for [ISL1539A](#). For more information on MSL please see techbrief [TB363](#).

# ISL1539A

## Absolute Maximum Ratings (T<sub>A</sub> = +25°C)

V <sub>S+</sub> to V <sub>S-</sub> Supply Voltage	-0.3V to +26.4V
V <sub>S+</sub> Voltage to GND	-0.3V to +26.4V
V <sub>S-</sub> Voltage to GND	-26.4V to +0.3V
Driver V <sub>IN+</sub> Voltage	V <sub>S-</sub> to V <sub>S+</sub>
C <sub>0</sub> , C <sub>1</sub> Voltage to GND	-0.3V to +6V
I <sub>ADJ</sub> Voltage to GND	-1V to +4V
ESD Rating	
Machine Model	200V
Human Body Model (Per MIL-STD-883 Method 3015.7)	3kV
Charge Device Model	1.5kV

## Thermal Information

Thermal Resistance (Typical)	θ <sub>JA</sub> (°C/W)	θ <sub>JC</sub> (°C/W)
24 Ld QFN Package (Notes 4, 5)	39	4.5
24 Ld HTSSOP Package (Notes 4, 5)	TBD	TBD
Maximum Junction Temperature (Plastic Package)	+150°C	
Current into any Input	8mA	
Continuous Output Current for Long Term Reliability	50mA	
Power Dissipation	See Figure 42	
Storage Temperature Range	-40°C to +150°C	
Pb-Free Reflow Profile	see link below	
	<a href="http://www.intersil.com/pbfree/Pb-FreeReflow.asp">http://www.intersil.com/pbfree/Pb-FreeReflow.asp</a>	

## Operating Conditions

Ambient Temperature Range	-40°C to +85°C
Junction Temperature Range	-40°C to +150°C

**CAUTION:** Do not operate at or near the maximum ratings listed for extended periods of time. Exposure to such conditions may adversely impact product reliability and result in failures not covered by warranty.

### NOTES:

- θ<sub>JA</sub> is measured with the component mounted on a high effective thermal conductivity test board in free air. QFN and HTSSOP exposed pad soldered to PCB per JESD51-5. See Tech Brief TB379 for details.
- For θ<sub>JC</sub>, the "case temp" location is the center of the exposed metal pad on the package underside.

**IMPORTANT NOTE:** All parameters having Min/Max specifications are guaranteed. Typ values are for information purposes only. Unless otherwise noted, all tests are at the specified temperature and are pulsed tests, therefore: T<sub>J</sub> = T<sub>C</sub> = T<sub>A</sub>

## Electrical Specifications

V<sub>S</sub> = ±12V, R<sub>L</sub> = 100Ω differential, I<sub>ADJ</sub> = C<sub>0</sub> = C<sub>1</sub> = 0V, A<sub>V</sub> = 10V/V, R<sub>F</sub> = 3.2kΩ, T<sub>A</sub> = +25°C. Amplifier pairs tested separately unless otherwise indicated.

PARAMETER	DESCRIPTION	CONDITIONS	MIN	TYP	MAX	UNIT
<b>AC PERFORMANCE</b>						
BW	-3dB Small Signal Bandwidth	V <sub>O</sub> < 2V <sub>P-P-DIFF</sub> , A <sub>V</sub> = 10		240		MHz
		V <sub>O</sub> < 2V <sub>P-P-DIFF</sub> (Note 6)		120		MHz
	-3dB Large Signal Bandwidth	V <sub>O</sub> = 10V <sub>P-P-DIFF</sub>		100		MHz
SR	20% to 80%	V <sub>O</sub> = 32V <sub>P-P-DIFF</sub>	2000	3000		V/μs
200kHz Harmonic Distortion	2nd Harmonic	V <sub>OUT</sub> = 10V <sub>P-P-DIFF</sub>		-93		dBc
	3rd Harmonic	V <sub>OUT</sub> = 10V <sub>P-P-DIFF</sub>		-90		dBc
	THD	V <sub>OUT</sub> = 10V <sub>P-P-DIFF</sub>		-88		dBc
1MHz Harmonic Distortion	2nd Harmonic	V <sub>OUT</sub> = 2V <sub>P-P-DIFF</sub>		-91		dBc
	3rd Harmonic	V <sub>OUT</sub> = 2V <sub>P-P-DIFF</sub>		-109		dBc
	THD	V <sub>OUT</sub> = 2V <sub>P-P-DIFF</sub>		-91		dBc
8MHz Harmonic Distortion	2nd Harmonic	V <sub>OUT</sub> = 2V <sub>P-P-DIFF</sub>		-87		dBc
	3rd Harmonic	V <sub>OUT</sub> = 2V <sub>P-P-DIFF</sub>		-95		dBc
	THD	V <sub>OUT</sub> = 2V <sub>P-P-DIFF</sub>		-86		dBc
MTPR	Multi-Tone Power Ratio	26kHz to 8MHz, 4kHz Tone Spacing, P <sub>LINE</sub> = 19dBm, VDSL2+ 8b (Note 6)		-70		dBc
200kHz Harmonic Distortion	2nd Harmonic	V <sub>OUT</sub> = 10V <sub>P-P-DIFF</sub> (Note 6)		-93		dBc
	3rd Harmonic	V <sub>OUT</sub> = 10V <sub>P-P-DIFF</sub> (Note 6)		-90		dBc
	THD	V <sub>OUT</sub> = 10V <sub>P-P-DIFF</sub> (Note 6)		-88		dBc

# ISL1539A

**Electrical Specifications**  $V_S = \pm 12V$ ,  $R_L = 100\Omega$  differential,  $I_{ADJ} = C_0 = C_1 = 0V$ ,  $A_V = 10V/V$ ,  $R_F = 3.2k\Omega$ ,  $T_A = +25^\circ C$ . Amplifier pairs tested separately unless otherwise indicated. **(Continued)**

PARAMETER	DESCRIPTION	CONDITIONS	MIN	TYP	MAX	UNIT
4MHz Harmonic Distortion	2nd Harmonic	$V_{OUT} = 10V_{P-P-DIFF}$ (Note 6)		-72		dBc
	3rd Harmonic	$V_{OUT} = 10V_{P-P-DIFF}$ (Note 6)		-70		dBc
	THD	$V_{OUT} = 10V_{P-P-DIFF}$ (Note 6)		-68		dBc
8MHz Harmonic Distortion	2nd Harmonic	$V_{OUT} = 2V_{P-P-DIFF}$ (Note 6)		-83		dBc
	3rd Harmonic	$V_{OUT} = 2V_{P-P-DIFF}$ (Note 6)		-78		dBc
	THD	$V_{OUT} = 2V_{P-P-DIFF}$ (Note 6)		-76		dBc
$e_N$	Non-Inverting Input Voltage Noise at each of the 4 Inputs	$f = 1MHz$		4.0		nV/ $\sqrt{Hz}$
$+i_N$	Non-Inverting Input Current Noise at each of the 4 Inputs	$f = 1MHz$		2.7		pA/ $\sqrt{Hz}$
$-i_N$	Inverting Input Current Noise at each of the 4 Inputs	$f = 1MHz$		23		pA/ $\sqrt{Hz}$
$e_{N-CM}$	Common Mode Output Noise at each Port Pair	$f = 1MHz$		90		nV/ $\sqrt{Hz}$
<b>POWER CONTROL FEATURES</b>						
$V_{IH}$	Logic High Voltage	$C_0$ and $C_1$ inputs	2.0			V
$V_{IL}$	Logic Low Voltage	$C_0$ and $C_1$ inputs			0.8	V
$I_{IH0}, I_{IH1}$	Logic High Current for $C_0, C_1$	$C_0 = 3.3V, C_1 = 3.3V$	-5	1	+5	$\mu A$
$I_{ILO}, I_{IL1}$	Logic Low Current for $C_0$ or $C_1$	$C_0 = 0V, C_1 = 0V$	-17	-13	-10	$\mu A$
$I_{ADJ}$	Input Resistance			500		$\Omega$
<b>SUPPLY CHARACTERISTICS</b>						
	Maximum Operating Supply Voltage			$\pm 12.6$		V
	Minimum Operating Supply Voltage			$\pm 7.5$		V
$I_{GND}$	GND Pin Current per Port	All outputs at 0V (Note 7)	0.2	0.4	0.5	mA
$I_{S+}$ (Full Power)	Positive Supply Current per Port	All outputs at 0V, $C_0 = C_1 = 0V$ , No Load	21	27.2	31.5	mA
$I_{S+}$ (Medium)	Positive Supply Current per Port	All outputs at 0V, $C_0 = 3.3V, C_1 = 0V$ , No Load	17.8	23	26.7	mA
$I_{S+}$ (Low)	Positive Supply Current per Port	All outputs at 0V, $C_0 = 0V, C_1 = 3.3V$ , No Load	10.4	13.5	15.6	mA
$I_{S+}$ (Power-down)	Positive Supply Current per Port	All outputs at 0V, $C_0 = C_1 = 3.3V$ , No Load	0.2	0.4	0.5	mA
<b>OUTPUT CHARACTERISTICS</b>						
$V_{OUT}$	Output Swing	$R_{L-DIFF} = \text{No Load}$	$\pm 10.7$	$\pm 10.9$		V
	Lightly Loaded Positive Swing	$R_{L-DIFF} = 100\Omega$	+10.3	+10.5		V
	Lightly Loaded Negative Swing	$R_{L-DIFF} = 100\Omega$		-10.4	-10.2	V
	Heavy Loaded Positive Swing	$R_{L-DIFF} = 60\Omega$	+9.4	+9.8		V
	Heavy Loaded Negative Swing	$R_{L-DIFF} = 60\Omega$		-9.7	-9.3	V
$I_{OL}$	Linear Output Current	$R_L = 25\Omega, f = 100kHz, THD = -60dBc$		$\pm 360$		mA

# ISL1539A

**Electrical Specifications**  $V_S = \pm 12V$ ,  $R_L = 100\Omega$  differential,  $I_{ADJ} = C_0 = C_1 = 0V$ ,  $A_V = 10V/V$ ,  $R_F = 3.2k\Omega$ ,  $T_A = +25^\circ C$ . Amplifier pairs tested separately unless otherwise indicated. **(Continued)**

PARAMETER	DESCRIPTION	CONDITIONS	MIN	TYP	MAX	UNIT
$I_{OUT}$	Peak Output Current	$V_{OUT} = \pm 1V$ , $R_L = 1\Omega$		$\pm 600$		mA
<b>INPUT CHARACTERISTICS</b>						
$V_{OS}$	Input Offset Voltage		-8	+3.5	+8	mV
$\Delta V_{OS}$	Input $V_{OS}$ Mismatch Between Amplifiers for Each Port		-2	0	+2	mV
$V_{OS, DRIFT}$	Input $V_{OS}$ Drift	$-25^\circ C$ to $+125^\circ C$ $T_J$		$\pm 15$		$\mu V/^\circ C$
$I_{B+}$	Non-Inverting Input Bias Current		-8		+8	$\mu A$
$\Delta I_{B+}$	Non-Inverting $I_{B+}$ Mismatch Between Amplifiers for Each Port		-2		+2	$\mu A$
$I_{B+, DRIFT}$	Non-Inverting $I_{B+}$ Drift	$-25^\circ C$ to $+125^\circ C$ $T_J$		$\pm 12$		nA/ $^\circ C$
$I_{B-}$	Inverting Input Bias Current		-75		+75	$\mu A$
$\Delta I_{B-}$	Inverting $I_{B-}$ Mismatch Between Amplifiers for Each Port		-35		+35	$\mu A$
$I_{B-, DRIFT}$	Inverting $I_{B-}$ Drift	$-25^\circ C$ to $+125^\circ C$ $T_J$		$\pm 25$		nA/ $^\circ C$
CMIR	Common Mode Input Range at each of the 4 Non-Inverting Input Pins			$\pm 7.5$		V
CMRR	Common Mode Rejections for each Port. $V_{CM} = -5V$ to $+5V$	$V_{CM}$ to Differential Mode Output (Input Referred)		80		dB
		$V_{CM}$ to Common Mode Output (Output Referred)		43		dB
PSRR	Power Supply Rejections for each Port to Differential Output (Input Referred)	$+V_S = +7.5V$ to $+12V$ , $-V_S = -12V$		97		dB
		$-V_S = -7.5V$ to $-12V$ , $+V_S = +12V$		92		dB
	Power Supply Rejections for each Port to Common Mode Output (Output Referred)	$+V_S = +7.5V$ to $+12V$ , $-V_S = -12V$		51		dB
		$-V_S = -7.5V$ to $-12V$ , $+V_S = +12V$		45		dB

**NOTES:**

6. Active Termination Test Circuit. Low Power Mode (see Figure 45).
7. The  $-V_S$  supply current is the  $+V_S$  supply current minus the ground current, except power down condition.

## Typical Performance Curves

$V_{CC} = \pm 12V$ ,  $R_F = 3.2k\Omega$ ,  $G_D = 10V/V$  (differential),  $R_{LOAD} = 100\Omega$ ,  $T_A \approx +25^\circ C$ ,  $C_0 = C_1 = I_{ADJ} = 0V$  (full power), unless otherwise noted.

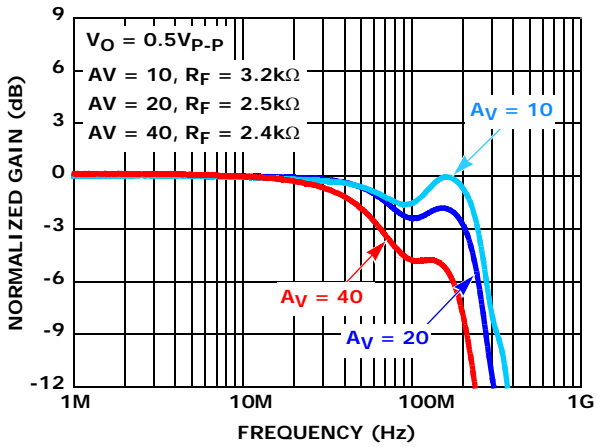

FIGURE 1. SMALL SIGNAL FREQUENCY RESPONSE vs GAIN

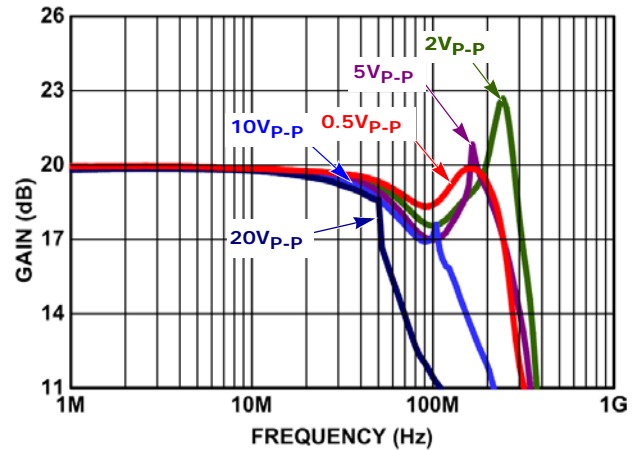

FIGURE 2. LARGE SIGNAL FREQUENCY RESPONSE

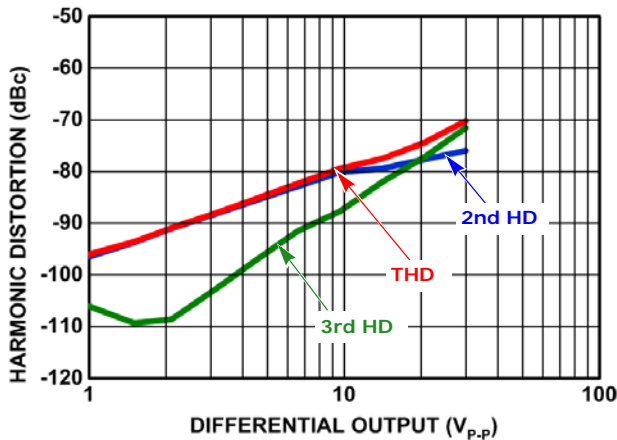

FIGURE 3. 1MHz HARMONIC DISTORTION vs OUTPUT SWING

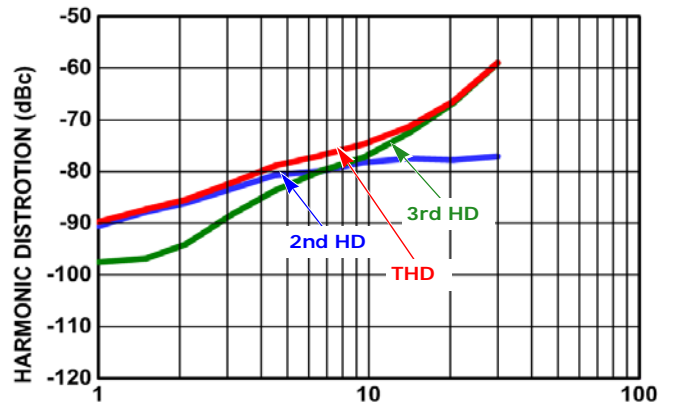

FIGURE 4. 4MHz HARMONIC DISTORTION vs OUTPUT SWING

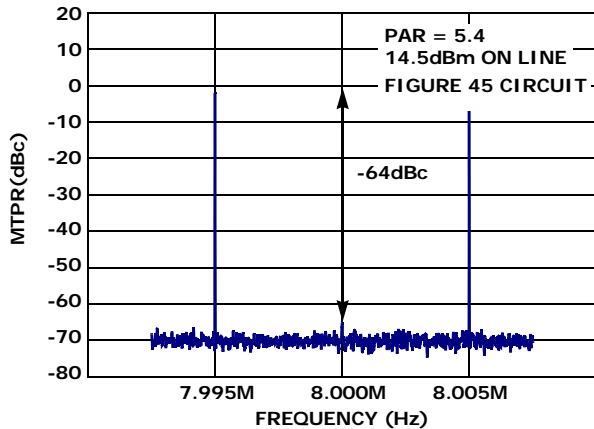

FIGURE 5. 17MHz DMT PROFILE

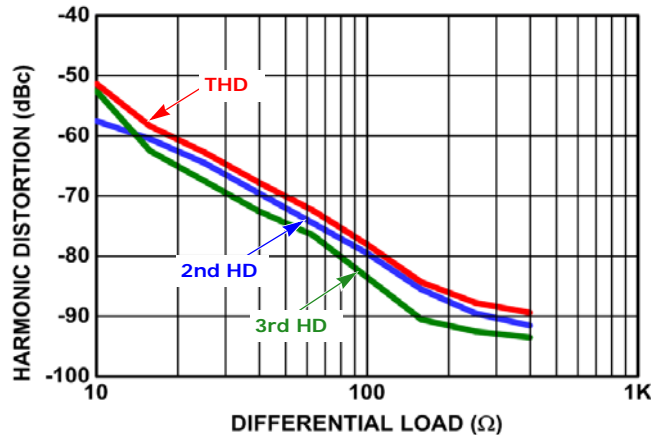

FIGURE 6. 4MHz HARMONIC DISTORTION vs LOAD

## Typical Performance Curves

$V_{CC} = \pm 12V$ ,  $R_F = 3.2k\Omega$ ,  $G_D = 10V/V$  (differential),  $R_{LOAD} = 100\Omega$ ,  $T_A \approx +25^\circ C$ ,  $C_0 = 3.3V$ ,  $C_1 = I_{ADJ} = 0V$  (medium power), unless otherwise noted.

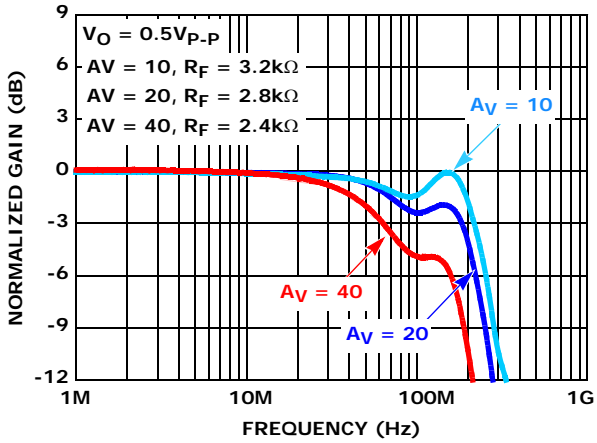

FIGURE 7. SMALL SIGNAL FREQUENCY RESPONSE vs GAIN

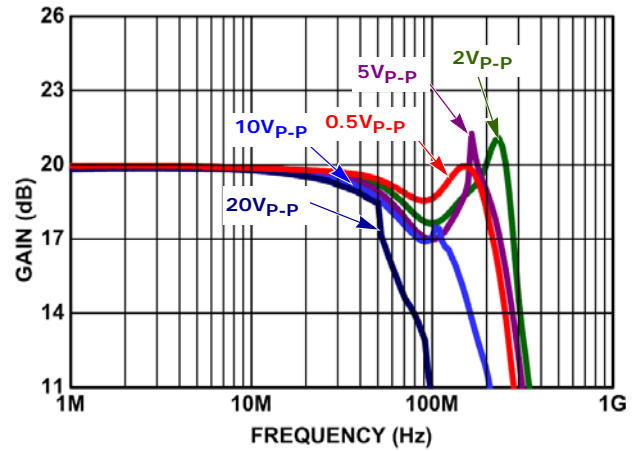

FIGURE 8. LARGE SIGNAL FREQUENCY RESPONSE

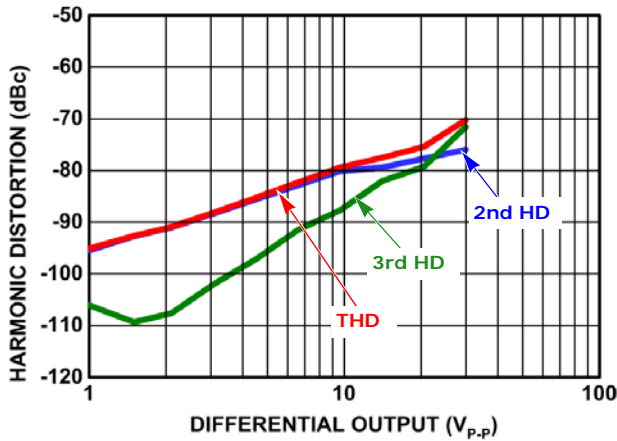

FIGURE 9. 1MHz HARMONIC DISTORTION vs OUTPUT SWING

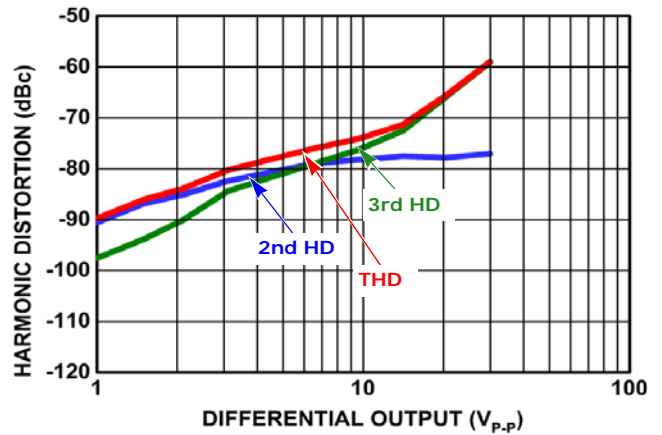

FIGURE 10. 4MHz HARMONIC DISTORTION vs OUTPUT SWING

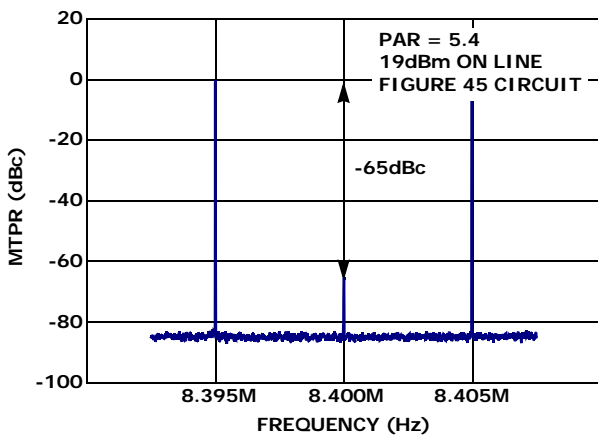

FIGURE 11. VDSL2+ 8MHz DMT PROFILE

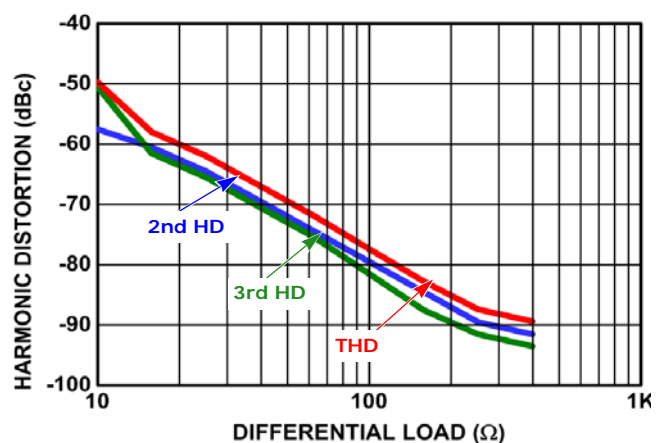

FIGURE 12. 4MHz HARMONIC DISTORTION vs LOAD



## Typical Performance Curves

$V_{CC} = \pm 12V$ ,  $R_F = 3.2k\Omega$ ,  $G_D = 10V/V$  (differential),  $R_{LOAD} = 100\Omega$ ,  $T_A \approx +25^\circ C$ ,  $C_1 = 3.3V$ ,  $C_0 = I_{ADJ} = 0V$  (low power), unless otherwise noted.

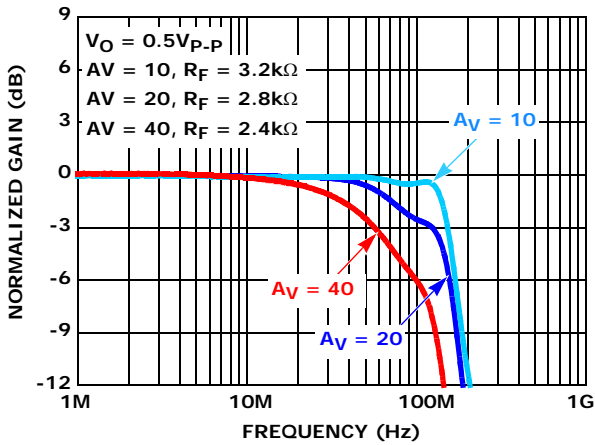

FIGURE 13. SMALL SIGNAL FREQUENCY RESPONSE vs GAIN

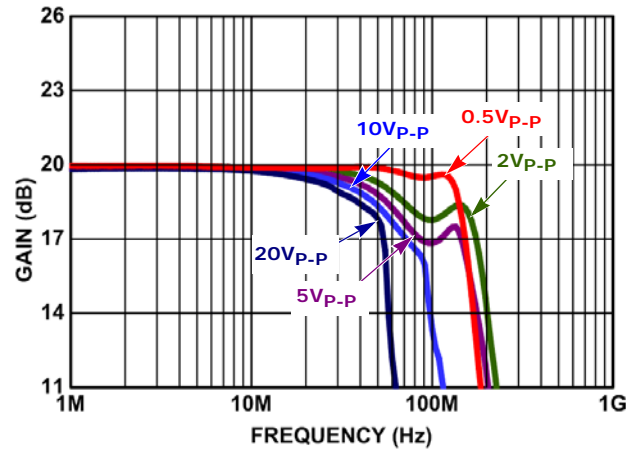

FIGURE 14. LARGE SIGNAL FREQUENCY RESPONSE

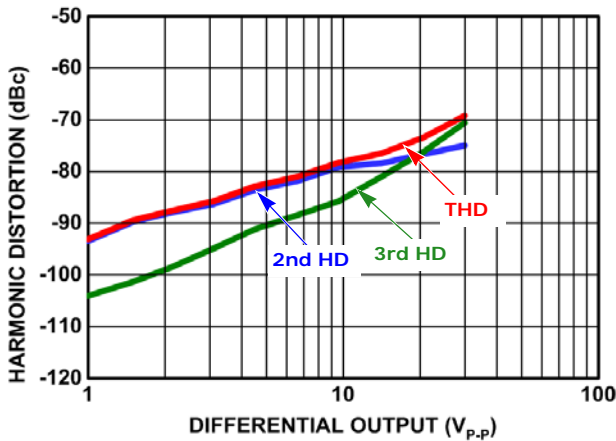

FIGURE 15. 1MHz HARMONIC DISTORTION vs OUTPUT SWING

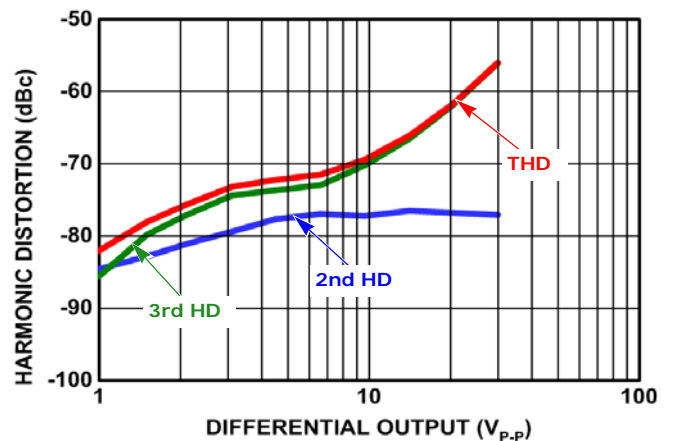

FIGURE 16. 4MHz HARMONIC DISTORTION vs OUTPUT SWING

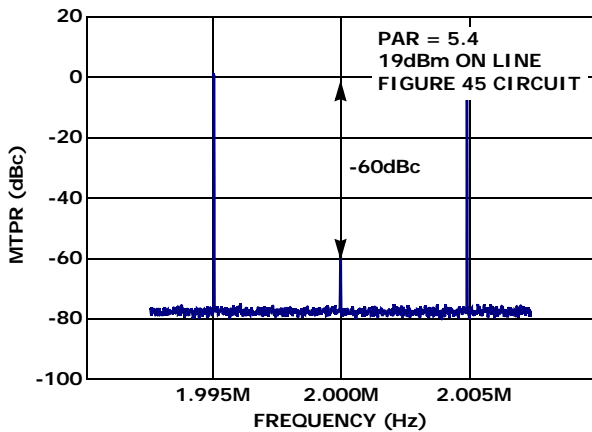

FIGURE 17. ADSL2+ DMT

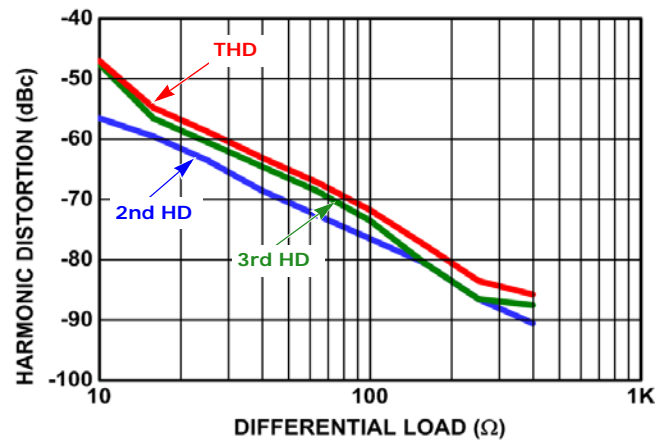

FIGURE 18. 4MHz HARMONIC DISTORTION vs LOAD

### Typical Performance Curves

$V_{CC} = \pm 12V$ ,  $R_F = 3.2k\Omega$ ,  $G_D = 10V/V$  (differential),  $R_{LOAD} = 100\Omega$ ,  $T_A \approx +25^\circ C$ ,  $C_0 = C_1 = I_{ADJ} = 0V$  (full power), unless otherwise noted.

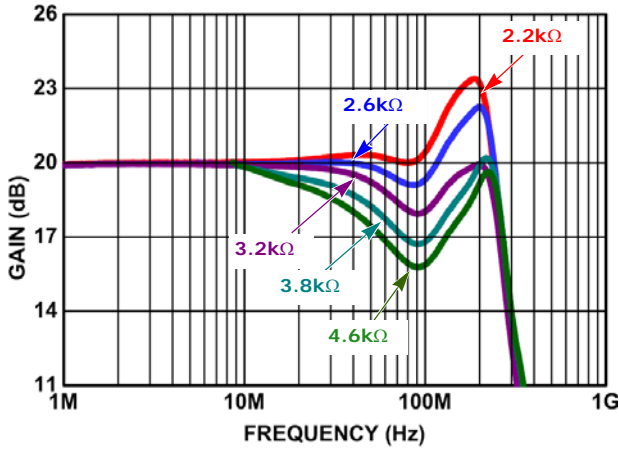

FIGURE 19. SMALL SIGNAL FREQUENCY RESPONSE vs  $R_F$

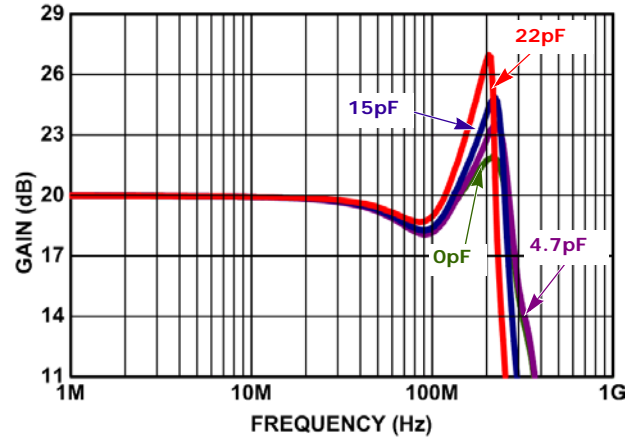

FIGURE 20. SMALL SIGNAL FREQUENCY RESPONSE vs  $C_{LOAD}$

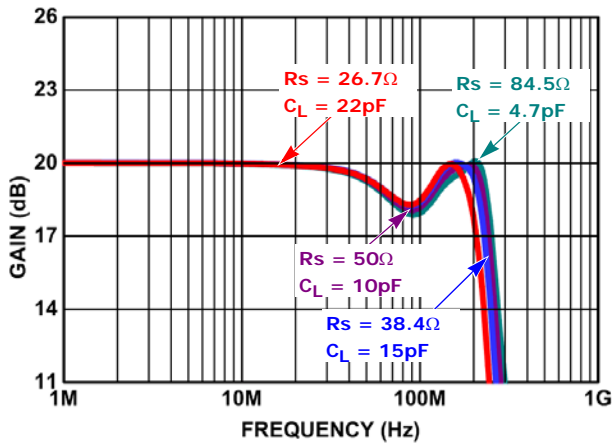

FIGURE 21. SMALL SIGNAL FREQUENCY RESPONSE vs  $C_{LOAD}$  WITH  $R_s$

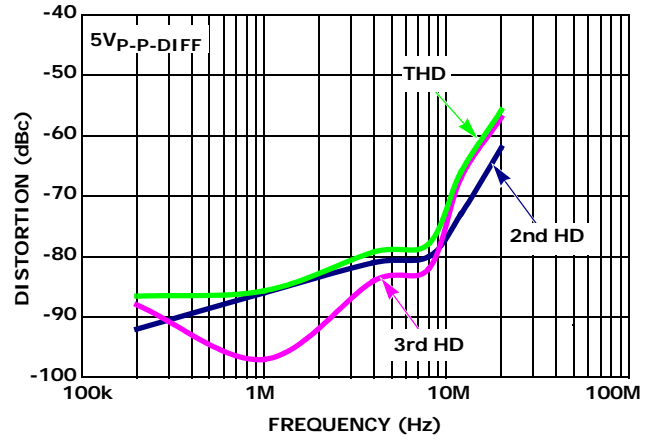

FIGURE 22. DISTORTION vs FREQUENCY

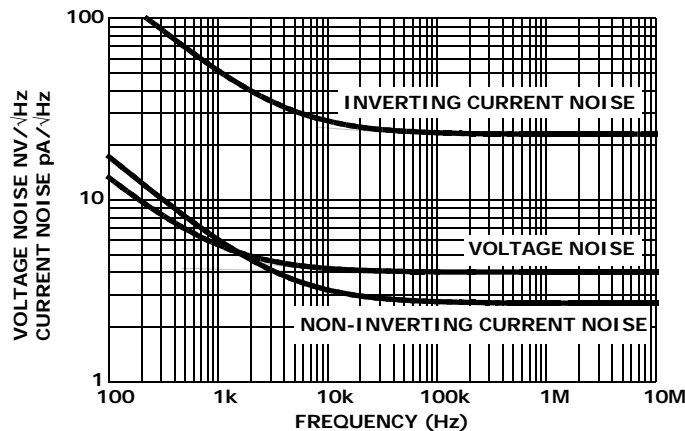

FIGURE 23. INPUT VOLTAGE AND CURRENT NOISE DENSITY

### Typical Performance Curves

$V_{CC} = \pm 12V$ ,  $R_F = 3.2k\Omega$ ,  $G_D = 10V/V$  (differential),  $R_{LOAD} = 100\Omega$ ,  $T_A \approx +25^\circ C$ ,  $C_0 = 3.3V$ ,  $C_1 = I_{ADJ} = 0V$  (medium power), unless otherwise noted.

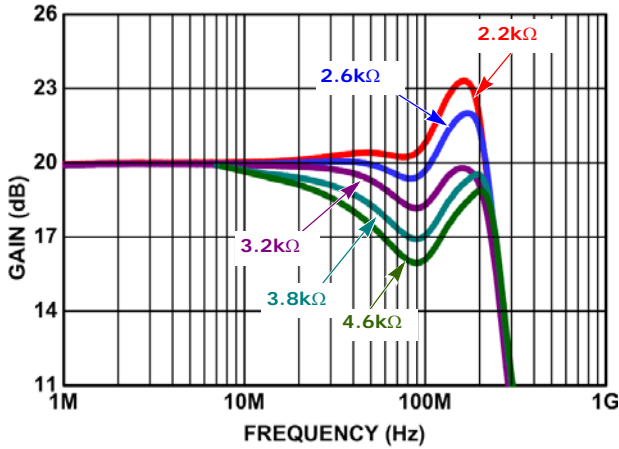

FIGURE 24. SMALL SIGNAL FREQUENCY RESPONSE vs  $R_F$

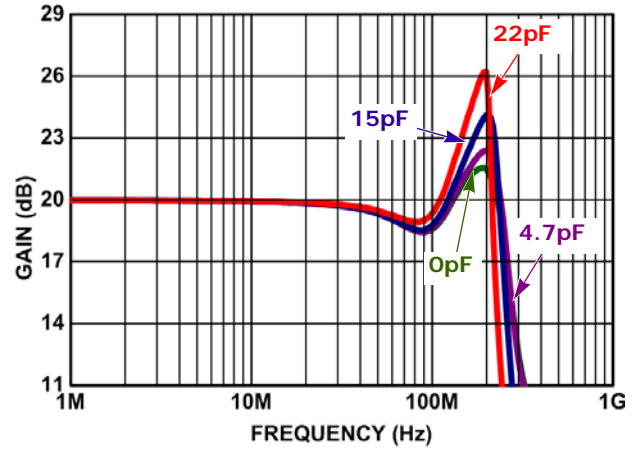

FIGURE 25. SMALL SIGNAL FREQUENCY RESPONSE vs  $C_{LOAD}$

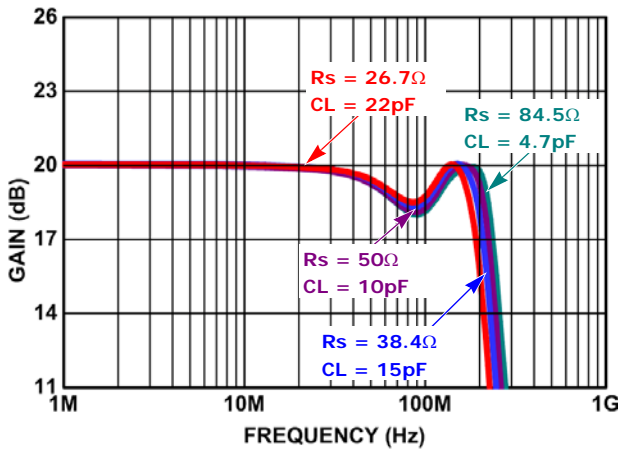

FIGURE 26. SMALL SIGNAL FREQUENCY RESPONSE vs  $C_{LOAD}$  WITH  $R_s$

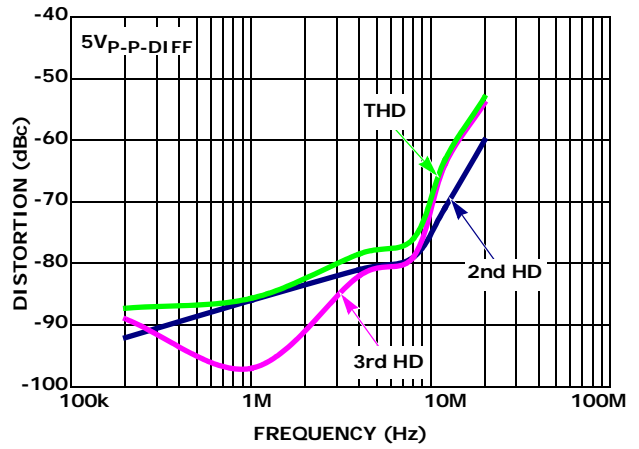

FIGURE 27. DISTORTION vs FREQUENCY

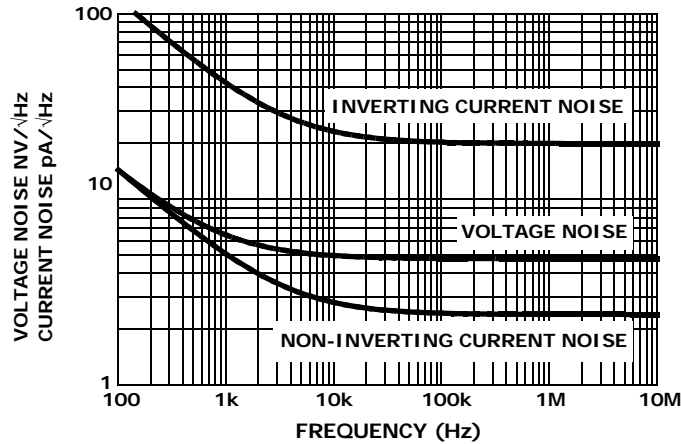

FIGURE 28. INPUT VOLTAGE AND CURRENT NOISE DENSITY

### Typical Performance Curves

$V_{CC} = \pm 12V$ ,  $R_F = 3.2k\Omega$ ,  $G_D = 10V/V$  (differential),  $R_{LOAD} = 100\Omega$ ,  $T_A \approx +25^\circ C$ ,  $C_1 = 3.3V$ ,  $C_0 = I_{ADJ} = 0V$  (low power), unless otherwise noted.

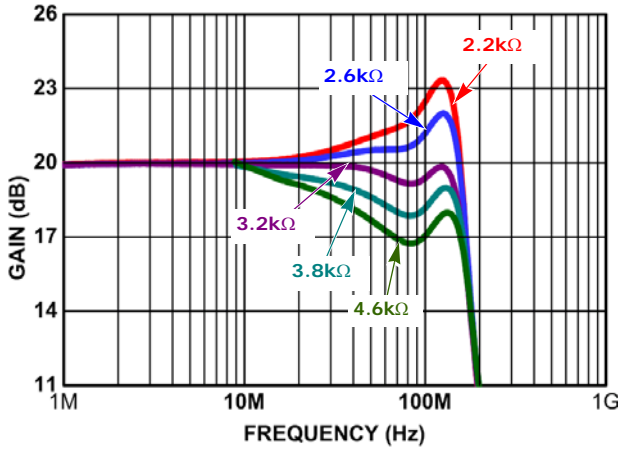

FIGURE 29. SMALL SIGNAL FREQUENCY RESPONSE vs  $R_F$

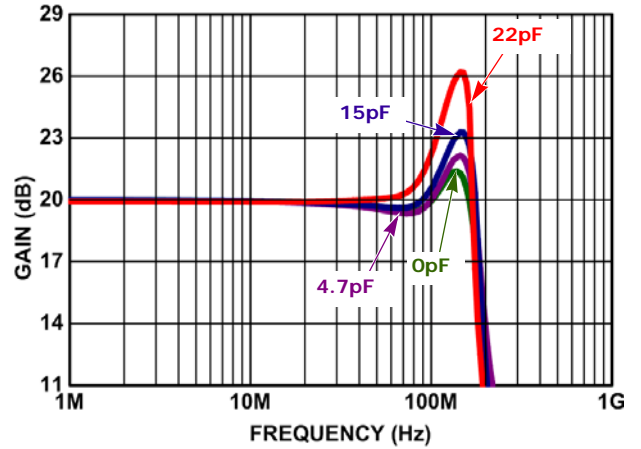

FIGURE 30. SMALL SIGNAL FREQUENCY RESPONSE vs CLOAD

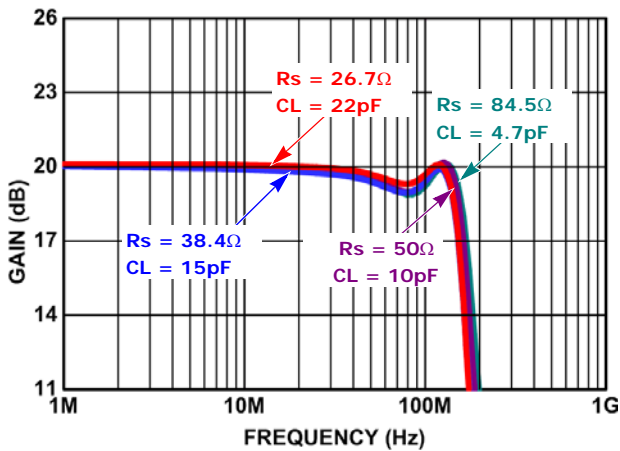

FIGURE 31. SMALL SIGNAL FREQUENCY RESPONSE vs CLOAD WITH  $R_s$

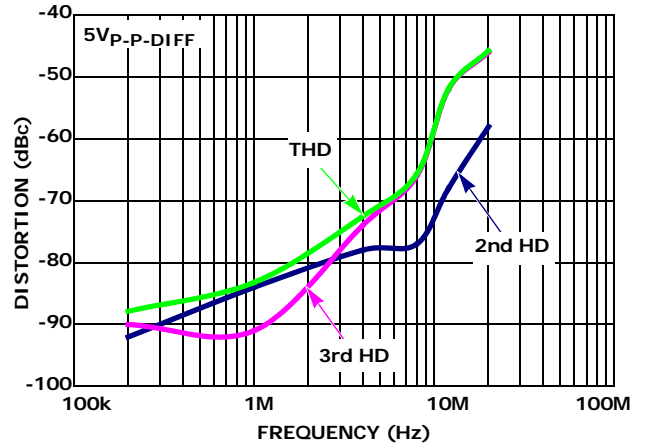

FIGURE 32. DISTORTION vs FREQUENCY

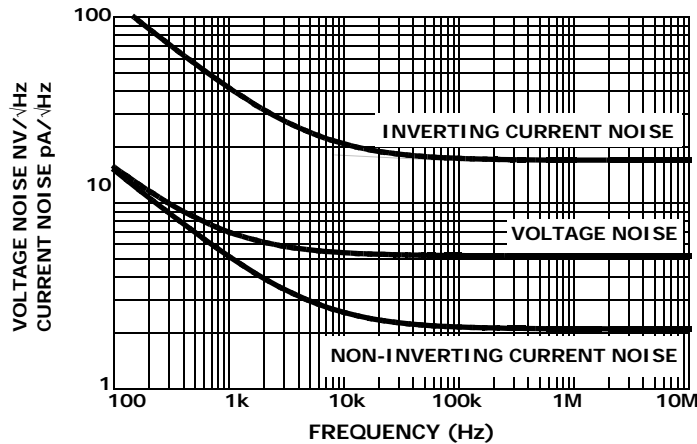

FIGURE 33. INPUT VOLTAGE AND CURRENT NOISE DENSITY

## Typical Performance Curves

$V_{CC} = \pm 12V$ ,  $R_F = 3.2k\Omega$ ,  $G_D = 10V/V$  (differential),  $R_{LOAD} = 100\Omega$ ,  $T_A \approx +25^\circ C$ , C0 and C1 Parametric, unless otherwise noted.

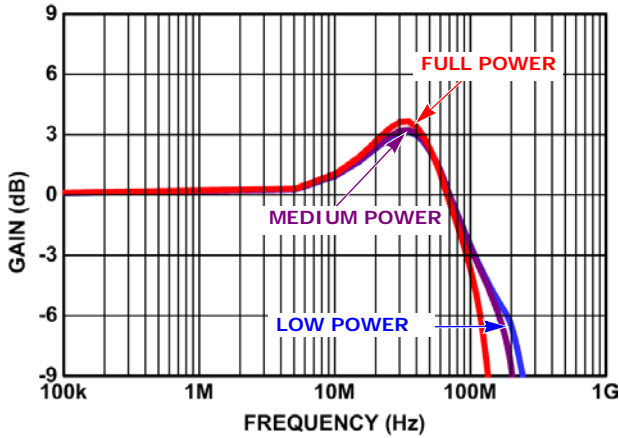

FIGURE 34. COMMON MODE SMALL SIGNAL FREQUENCY RESPONSE

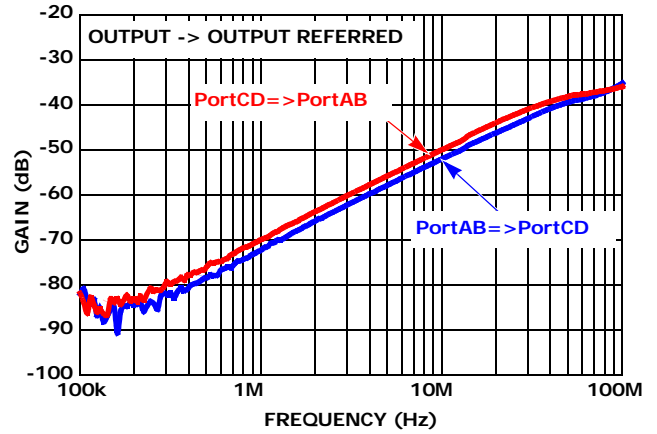

FIGURE 35. CHANNEL TO CHANNEL X-TALK

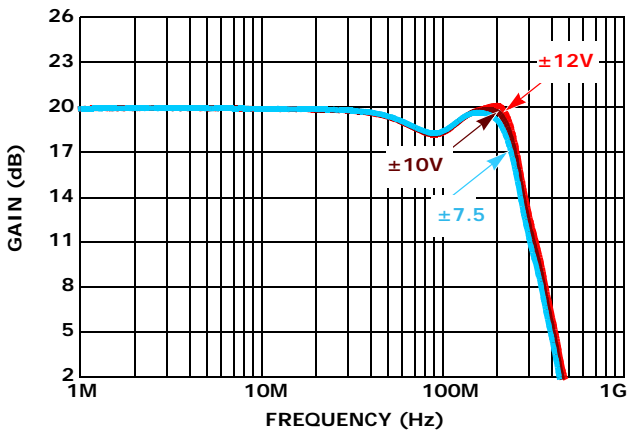

FIGURE 36. SMALL SIGNAL BANDWIDTH vs SUPPLY VOLTAGE

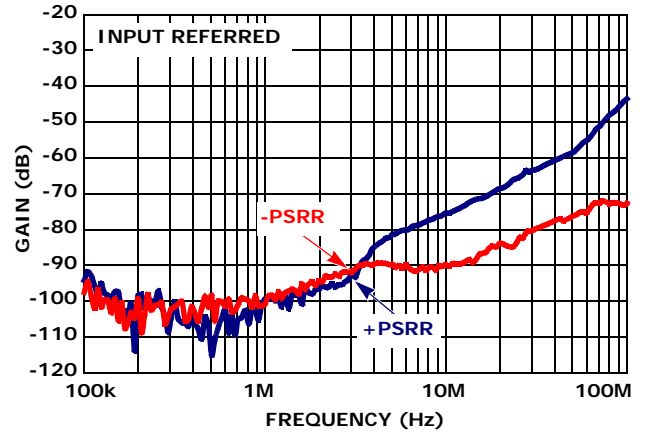

FIGURE 37. +PSRR TO DIFFERENTIAL OUTPUT

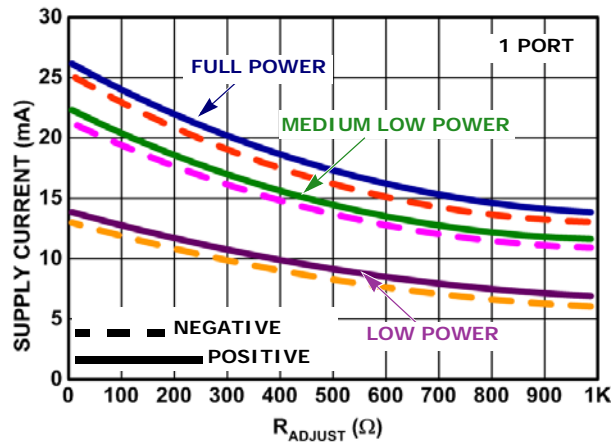

FIGURE 38. SUPPLY CURRENT vs  $R_{ADJ}$

### Typical Performance Curves

$V_{CC} = \pm 12V$ ,  $R_F = 3.2k\Omega$ ,  $G_D = 10V/V$  (differential),  $R_{LOAD} = 100\Omega$ ,  $T_A \approx +25^\circ C$ ,  $I_{ADJ} = 0V$ ,  $C_0, C_1$  varied, unless otherwise noted.

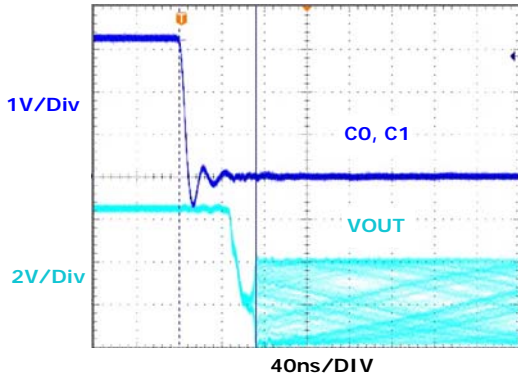

FIGURE 39. POWER-UP TIME

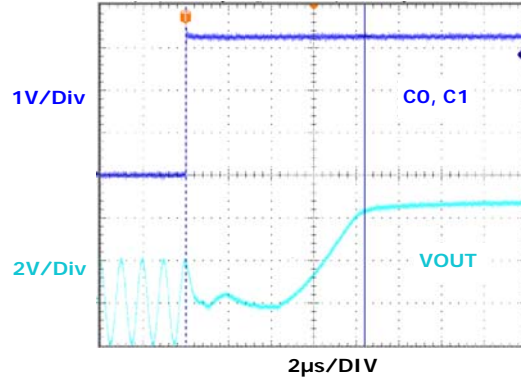

FIGURE 40. POWER-DOWN TIME

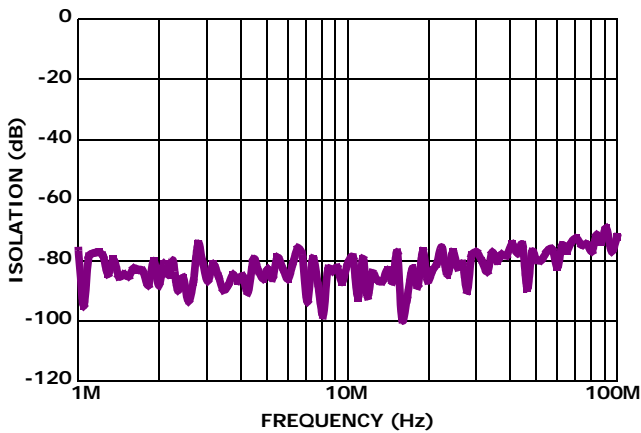

FIGURE 41. OFF-ISOLATION

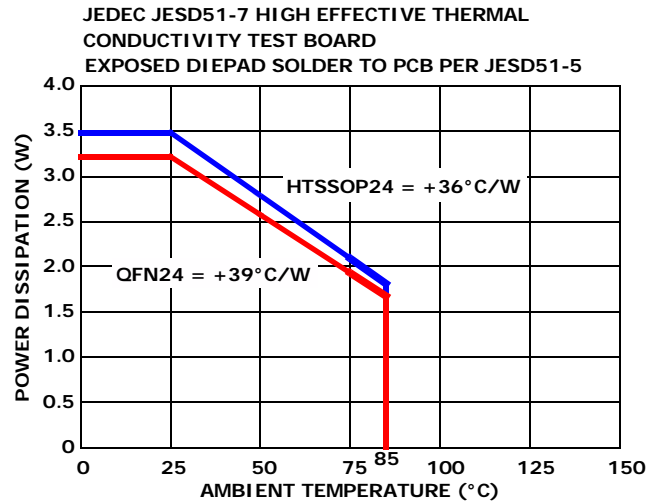

FIGURE 42. PACKAGE POWER DISSIPATION vs AMBIENT TEMPERATURE

## Test Circuit

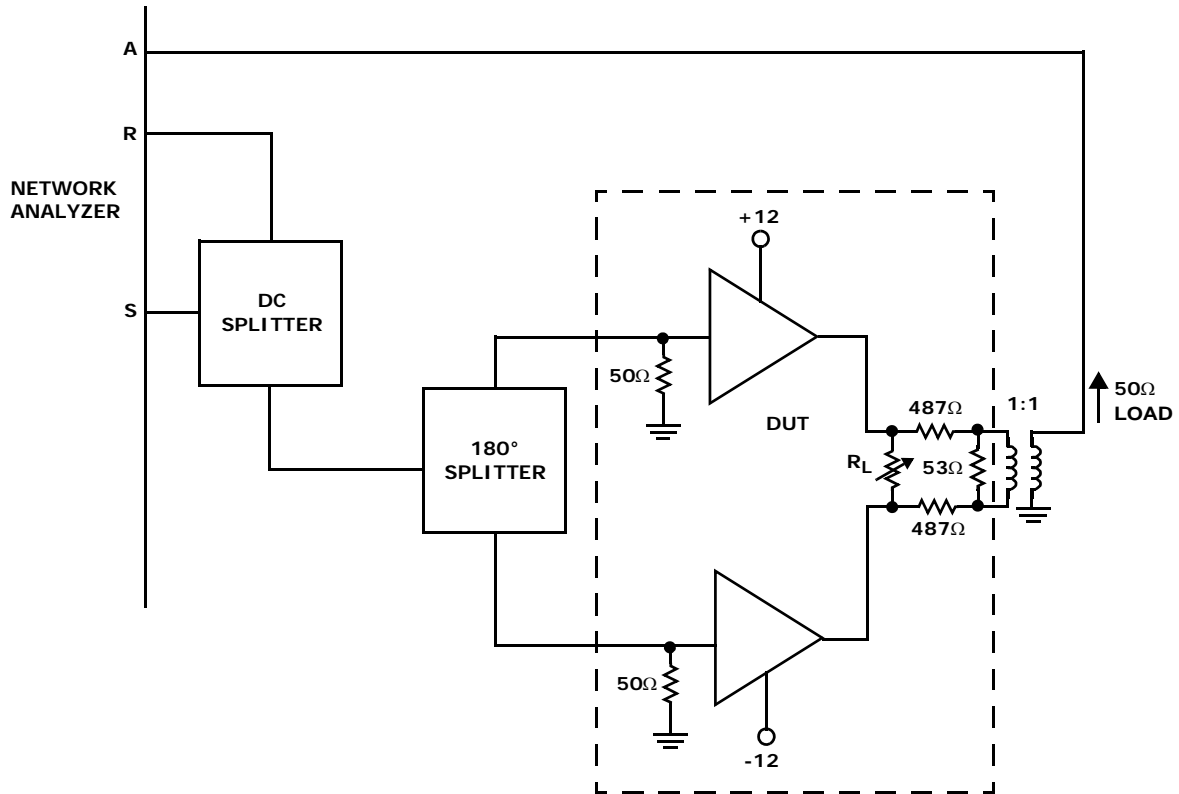

FIGURE 43. FREQUENCY RESPONSE CHARACTERIZATION CIRCUIT

## Applications Information

### Applying Wideband Current Feedback Op Amps as Differential Drivers

A current feedback amplifier (CFA) like the ISL1539A is particularly suited to the requirements of high output power, high full power bandwidth, differential drivers. This topology offers a very high slew rate on low quiescent power and the ability to hold relatively constant AC characteristics over a wide range of gains. The AC characteristics are principally set by the feedback resistor value in simple differential gain circuits as shown in Figure 44.

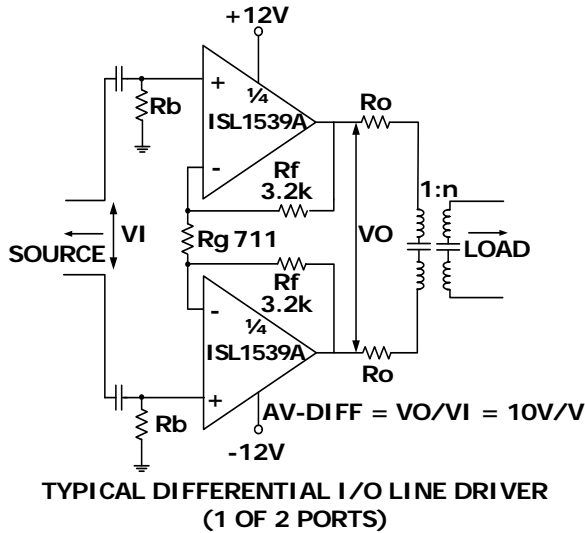

FIGURE 44. PASSIVE TERMINATION CIRCUIT

In this differential gain of 10 V/V circuit, the 3.2k feedback resistors are setting the bandwidth while the 711 gain resistor controls the gain. The  $V_o/V_i$  gain for this circuit is set by Equation 1:

$$\frac{V_o}{V_i} = 1 + 2 \frac{R_f}{R_g} = 1 + 2 \frac{3.2k\Omega}{711\Omega} = 10 \quad (\text{EQ. 1})$$

The effect of increasing or decreasing the feedback resistor value is shown in Figures 19, 24 and 29 (at the 3 power settings). Increasing  $R_f$  will tend to roll off the response while decreasing it will peak the frequency response up extending the bandwidth.  $R_g$  was adjusted in each of these plots to hold a constant gain of 10 (or 20dB). This shows the flexibility offered by the CFA topology - the frequency response can be controlled with the value of the feedback resistor with the  $R_g$  resistor then setting the desired gain.

The ISL1539A provides 4 very power efficient, high output current, CFA's. These are intended to be connected as two pairs of differential drivers. The pinout diagrams of page two show that Channels A and B are intended to operate as a pair while Channels C and D comprise the other pair. Power control is also provided through two pairs of control pins which separately set the

power for Channels A and B together and then the other pair controls Channels C and D together.

Very low output distortion at low power can be provided by the differential configuration. The high slew rate intrinsic to the CFA topology also contributes to the exceptional performance shown in Figures 22, 27 and 32. These swept frequency distortion plots show extremely low distortion at 200kHz holding to very low levels up through 20MHz. At the lowest operating power (Figure 32, which is at low power, or 6.75mA per amplifier or 13.5mA/port) we still see < -70dBc through 5MHz for a 5V<sub>p-p</sub> differential output swing.

### Advanced Configurations - Active Termination

Where the best power efficiency is required in a full duplex DSL line interface application, it is common to apply the circuit shown below to reduce the power loss in the matching element while retaining a higher impedance for the upstream signal coming into this output stage. This circuit acts to provide a higher apparent output impedance (through its cross-coupled positive feedback through the  $R_p$  resistors) while physically taking a smaller IR drop through the  $R_m$  resistors for the output signal.

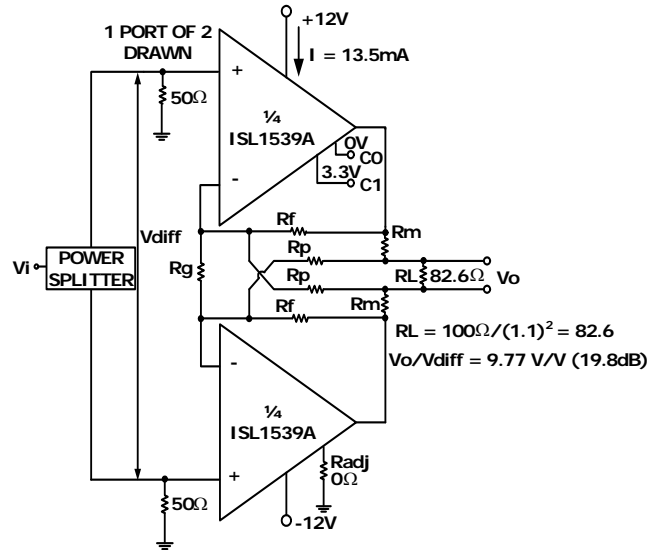

FIGURE 45. ACTIVE TERMINATION TEST CIRCUIT

This circuit is showing one of two ports configured in an active termination circuit used for some of the specification and characterization tests. This is showing the device operating in the low power mode, but data has been shown at the other power settings as well.

The 82.6Ω differential load is intended to emulate a 100Ω line load reflected through a 1:1.1 turns ratio transformer ( $100\Omega/(1.1)^2 = 82.6\Omega$  load). The gain and output impedance for this circuit can be described by the following equations.

The ideal transfer function is set by the open circuit gain ( $R_L = \text{infinite}$ ) and an equivalent output impedance  $Z_O$ .



$$\frac{V_o}{V_i} = A_{oc} \frac{R_L}{R_L + Z_o} \quad (\text{EQ. 2})$$

The goal of the positive feedback resistor,  $R_p$ , is to provide some "gain" in the apparent output impedance over just the  $2 \cdot R_M$ . It also will act to increase the  $A_{OC}$  over the simple differential gain equation if a synthesis factor (SF) is defined as shown in Equation 3:

$$SF = \frac{1}{1 - \frac{R_f - R_m}{R_p}} \quad (\text{EQ. 3})$$

We can see this "gain" is achieved by letting  $R_p$  be  $> R_f$ . The closer  $R_p$  is to  $R_f - R_m$ , the more "gain" is achieved but at the risk of instability. With this SF defined as shown above, the exact  $A_{OC}$  and  $Z_o$  will be as shown in Equations 4 and 5:

$$A_{oc} = SF \left( 1 + 2 \frac{R_f}{R_g} + \frac{R_f - R_m}{R_p} \right) \quad (\text{EQ. 4})$$

$$Z_o = SF(2R_m) \quad (\text{EQ. 5})$$

For test purposes, the circuit shown in Figure 45 was configured to achieve the following results.

$$SF = 2.19$$

$$A_{OC} = 17.7V/V$$

$$Z_o = 66\Omega$$

Putting these together into the gain to an  $82.6\Omega$  load gives the following test condition as shown by Equation 6.

$$\frac{V_o}{V_i} = A_{oc} \frac{R_L}{R_L + Z_o} = 17.7 \frac{82.6\Omega}{82.6\Omega + 66\Omega} = 9.84 \left( \frac{V}{V} \right) \quad (\text{EQ. 6})$$

The advantage offered by this technique is that for whatever swing we desire at the load, there is less rise through the physical output matching resistor than if we simply inserted two  $33\Omega$   $R_M$  resistors to achieve the  $66\Omega$  output impedance achieved in this test circuit. Whatever load current is required in  $R_L$  will rise to the output pins through  $2 \cdot R_M$ . The rise from the load swing to the output pin swing is given by Equation 7:

$$\frac{R_L + 2R_m}{R_L} \quad (\text{EQ. 7})$$

This was only 1.36 for the test circuit shown above. In differential circuits the  $\pm V_p$  at the output pins produces a  $4V_p$  for the differential peak-to-peak voltage. Hence a  $\pm 10V$  swing at each output in the above circuit will

produce a  $40V_{p,p}$  differential swing which will drop to the load divided by 1.36 - or a  $29.41V_{p,p}$  differential swing.

## Distortion and MTPR

The ISL1539A is intended to provide very low distortion levels under the demanding conditions required by the discrete multi-tone (DMT) characteristic of modern DSL modulations. The standard test for linearity is the Multi-Tone Power Ratio (MTPR) test where a specified standard is loaded up with discrete carriers over the specified frequencies in such a way as to produce the maximum rated line power and Peak to Average Ratio (PAR) with some tones missing. The measure of linearity is the separation from the active tones vs. a missing tone. To the extent that the amplifier is slightly non-linear, it will fold a small amount of power into the missing tones through intermodulation products for the active tones. Figure 17 shows the circuit operating at the low power setting used to test ADSL2+ frequency plan and power. For this test the carriers are spaced at 5kHz.

This -60dBc MTPR is exceptional for the very low 13.5mA total quiescent current used in this configuration. Operating at reduced power targets on the line will improve MTPR as will operating the amplifiers at higher quiescent current.

The characteristic curves show the exceptional single tone performance available using the ISL1539A. At the highest quiescent power, operating at a simple differential gain of 10V/V, Figure 22 shows the  $5V_{p,p}$  distortion plot.

Figure 22 shows a better than -80dBc through 8MHz for the 2nd and 3rd harmonics. The rapid rise in the spurious above 10MHz is coming from the onset of fine scale slew limiting effects. By 20MHz, the output signal is requiring a differential slew rate of  $300V/\mu s$  - a significant portion of the available  $3000V/\mu s$  slew rate available at full power.

## Power Control Function

Figure 46 shows a simplified schematic for the power control features included in the ISL1539A. Each of the 4 differential pairs shown in the drawing are used to steer control currents ( $I_{BIAS}$  terms) into additional current mirrors (not shown) that control the quiescent bias current for each of the two ports. This bias control shares the  $I_{ADJ}$  pin. When  $I_{ADJ}$  is grounded, the typical supply current levels shown in the "Electrical Specifications" tables on page 5 are produced. Inserting an external resistor to ground in the  $I_{ADJ}$  pin will scale the quiescent currents down, as shown in Figure 38.

It is also possible to scale the  $I_{ADJ}$  currents up by tying the  $I_{ADJ}$  pin through a resistor to a negative supply. As long as the resulting voltage divider between this external negative voltage and the internal +0.4V on the other side of the  $500\Omega$  resistor stays above the maximum rated negative voltage on the  $I_{ADJ}$  pin (-1V). For instance, to double the typical quiescent current levels, the current in the  $I_{ADJ}$  pin must be doubled from its nominal  $800\mu A$  level. Using a -5V supply through an

external 2.88kΩ resistor will double the current while leaving the I<sub>ADJ</sub> pin voltage at approximately -0.4V, which is well within rated minimum. This approach should be used with great caution as very high internal power dissipations can easily be produced. However, it can be a useful approach to extend operation, particularly when operating on lower total supply voltages than the rated typical of ±12V.

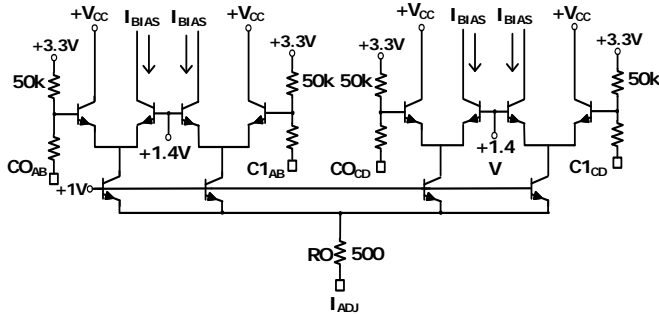

FIGURE 46. BIAS CONTROL CIRCUIT

The current in RO divides in 1/4 levels to form the bias current for the 4 pairs of differential switches. Each pair of switches controls the quiescent current for one port. For instance, CO<sub>AB</sub> and C1<sub>AB</sub> control the quiescent current for the port constructed from amplifiers A and B. If both control lines are unconnected externally, the internal 50kΩ pull-up will switch the differential pairs to divert the 100μA tail currents into the supply turning off the amplifiers. Taking both control pins low will pass both I<sub>BIAS</sub> lines on into scaling current sources. With I<sub>REF</sub> grounded, this will give the typical 27.2mA total quiescent current for a port shown in the “Electrical Specification” tables on page 5. Taking C<sub>0</sub> high (>2V) while leaving C<sub>1</sub> low (<0.8V) will reduce the current into a port to a typical 23mA. Taking C<sub>1</sub> high, while leaving C<sub>0</sub> low will reduce the current in a port to a typical 13.5mA supply current. Table 2 summarizes the operation modes for ISL1539A for each port.

TABLE 2. POWER MODES OF THE ISL1539A

C <sub>1</sub>	C <sub>0</sub>	OPERATION
0	0	I <sub>S</sub> Full Power Mode
0	1	I <sub>S</sub> Medium Power Mode
1	0	I <sub>S</sub> Low Power Mode
1	1	Power-Down

## Performance Considerations

### Driving Capacitive Loads

All closed loop op amps are susceptible to reduced phase margin when driving capacitive loads. This shows up as peaking in the frequency response that can, in extreme situations, lead to oscillations. The ISL1539A is designed to operate successfully with small capacitive loads such as layout parasitics. As the parasitic capacitance increases, it is best consider a small resistor in series

with the output to isolate the phase margin effects of the capacitor. Figure 20 on page 10 shows the effect of capacitive load on the differential gain of 10 circuit. With 15pF on each output, we see about 5dB peaking. This will increase quickly at higher C<sub>loads</sub>. If this degree of peaking is unacceptable, a small series resistor can be used to improve the flatness as shown in Figure 21.

### Output DC Error Model

Often, non-inverting bias current (ibn), inverting bias current (ibi), and input offset voltage (Vio) are quite low for typical op amps.

Vio, ibn, ibi can be mapped to output offset both common and differential mode. Consider the circuit in Figure 47.

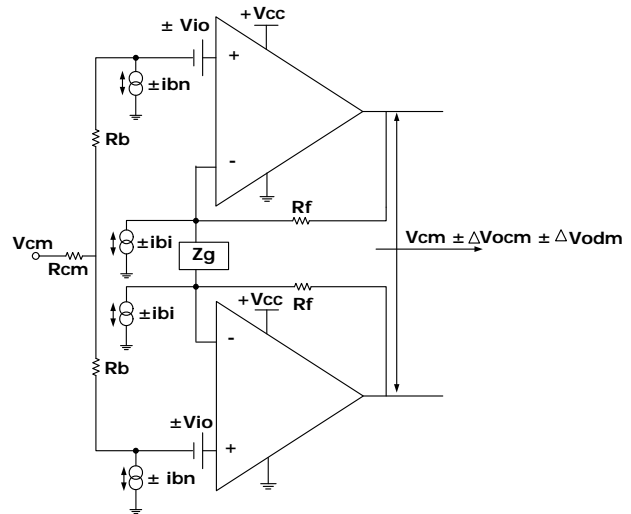

FIGURE 47. DC ERROR MODEL

The output common mode offset voltage (Vo-cm) is derived from the input common mode voltage (Vi-cm), as expressed in Equations 8 and 9:

$$V_{icm} = \pm 2 \times ibn \times R_{cm} \pm ibn \times R_b \pm V_{io} \quad (EQ. 8)$$

$$V_{ocm} = \pm V_{icm} \pm R_f \times ibi \quad (EQ. 9)$$

The output differential mode offset voltage (Vo-dm) is derived from the input differential mode voltage (Vi-dm), as expressed in Equations 10 and 11:

$$V_{idm} = \pm \Delta ibn \times R_b \pm \Delta V_{io} \quad (EQ. 10)$$

$$V_{odm} = \pm V_{idm} \times \left(1 + \frac{2R_f}{R_g}\right) \pm \Delta ibi \times R_f \quad (EQ. 11)$$

Example:

Referring to the “Electrical Specification” tables on page 6:

$$ibn = 8\mu A, \Delta ibn = 2\mu A$$

$$ibi = 75\mu A, \Delta ibi = 35\mu A$$

$$V_{io} = 8mV, \Delta V_{io} = 2mV$$

Assuming  $R_f = 3k\Omega$ ,  $R_g = 333\Omega$ ,  $R_b = 7.5k\Omega$ ,  $R_{cm} = 5k\Omega$ , the total output offset voltage derived is expressed in Equation 12:

$$V_{cm} = V_{ocm} + 0.5 \times V_{odm} = 434mV \quad (EQ. 12)$$

Given the worst case DC errors, 434mV of DC shift will be at the output reducing the available output swing slightly. Actual operation should never see this much shift as the error terms are not completely independent.

**Output Headroom Model**

Driving high voltages into heavy loads will require a careful consideration of the available output swing vs. load. Figure 48 shows a useful model for predicting the available output swing. If the output is modeled as ideal NPN and PNP transistors, the output swing limits can be described as no load headrooms ( $V_p$  and  $V_n$ ) and an equivalent impedance to the supplies ( $R_p$  and  $R_n$ )

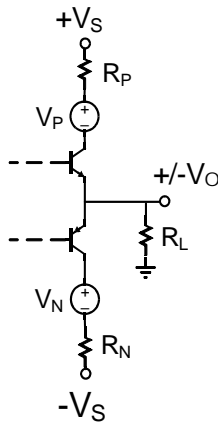

**FIGURE 48. HEADROOM MODEL**

The no load headrooms can be found in the “Electrical Specifications” table on page 5 as  $12V - 10.9V = 1.1V$  and they are equal to each supply.

The equivalent impedances for this model can be extracted from the reduced swings shown in the specification table for the heavier loads. Looking at the typical  $60\Omega$  load swings, we see a  $+9.8V$  and  $-9.7V$  swing. Solving for the two resistors in the Headroom model shown in Figure 48 gives:

$$R_p = 6.7\Omega \text{ and } R_n = 7.4\Omega$$

For the differential configuration, Figure 49 shows the Headroom model that can be used to predict the maximum available swing for a given supply voltage and load resistor,  $R_L$ .

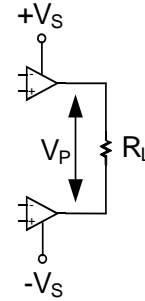

**FIGURE 49. HEADROOM MODEL**

For equal bipolar supplies, the available peak output swing will be given by Equation 13:

$$V_p = \frac{2(V_s - V_p - V_n)}{1 + \frac{R_p + R_n}{R_L}} \quad (EQ. 13)$$

For example, to worst case the typical gain of 10 design using  $\pm 12V$  supplies with  $\pm 5\%$  supply tolerance and a minimum expected load of  $90\Omega$ , a maximum  $V_p$  can be calculated as shown in Equation 14:

$$V_p = \frac{2(V_s - V_p - V_n)}{1 + \frac{R_p + R_n}{R_L}} = \frac{2(11.4 - 2.2)}{1 + \frac{6.7\Omega + 7.4\Omega}{90\Omega}} = 15.9V_p \quad (EQ. 14)$$

The minimum  $V_{p,p}$  would be twice this, or  $31.8V_{p,p}$ . While this extreme condition would normally not be encountered, it does show the importance of knowing your minimum expected load for high output swing conditions.

**Output Noise Model**

The full differential output noise model for the ISL1539A should include the 3 input noise terms for each device as well as the noise contributions due to the external resistors.

This necessarily becomes an involved model due to the number of terms, but if the terms that are the same on each side of the differential circuit can be assumed to be equal, it will simplify considerably. The noise model shown in Figure 50 includes all of the op amp terms and resistor terms. This model is directed at calculating the differential output spot noise for different values of the resistors in the simple differential gain circuit. It is assuming each amplifier term is independent and uncorrelated to the other terms.

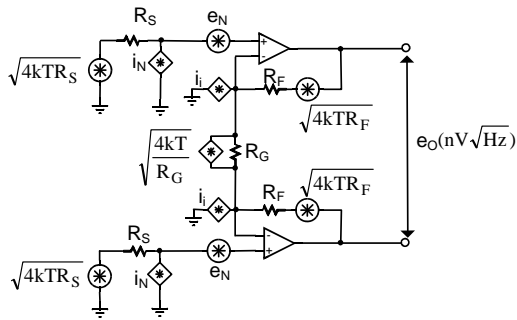

FIGURE 50. OUTPUT NOISE MODEL

In Figure 50, the circle sources are noise voltages while the diamonds are noise currents and  $4kT$  is  $1.6E - 20J$ .

If the op amp terms are assumed to be equal for the two sides of the circuit and two  $R_F$  and  $R_S$  resistors are also equal, and the differential gain is defined as  $A_d = 1 + 2R_F/R_G$ , the differential output noise expression becomes Equation 15.

$$e_o = \sqrt{2(A_d^2)(e_n^2 + (i_n R_s)^2 + 4kTR_s) + 2(i_i R_f)^2 + 2A_d(4kTR_f)} \quad (\text{EQ. 15})$$

Putting in numbers for the gain of 10 characterization circuit (with  $R_S = 50\Omega$ ) gives a differential output noise of  $e_o = 69\text{nV}/\sqrt{\text{Hz}}$ . Dividing this by the differential gain of 10 gives an input noise of  $e_i = 6.9\text{nV}/\sqrt{\text{Hz}}$  which is only slightly more than the RMS sum of the two  $4\text{nV}$  input voltage noise terms for the op amps themselves ( $5.7\text{nV}/\sqrt{\text{Hz}}$ ).

## Board Design Recommendations

The feedback resistors need to be placed as close as possible to the output and inverting input pins to minimize parasitic capacitance in the feedback loop. This includes the  $R_F$  and  $R_P$  resistors in the active termination configuration. Keep the gain resistor also very close to the inverting inputs for its port and minimize parasitic capacitances to ground or power planes as well.

Close placement of the supply decoupling capacitors will minimize parasitic inductance in the supply path. High frequency load currents are typically pulled through these capacitors so close placement of  $0.01\mu\text{F}$  capacitors on each of the supply pins will improve dynamic performance. Higher valued capacitors,  $6.8\mu\text{F}$  typically, can be placed further from the package as they are providing more of the low frequency decoupling.

The thermal pad for the ISL1539A should be connected to either ground or the  $-V_S$  power plane. The choice of which plane depends on which one would have the more accessible thermal area.

While the ISL1539A is relatively robust in driving parasitic capacitive loads, it is always preferred to get into any series output resistor needed in the design as physically close as possible to the output pins. Then trace capacitance on the other side of that resistor will have a much smaller effect on loop phase margin.

Protection devices that are intended to steer large load transients away from the ISL1539A output stage and into the power supplies or ground should have a short trace from their supply connections into the nearest supply capacitor - or should include their own supply capacitors to provide a low impedance path under fast transient conditions.

## Revision History

The revision history provided is for informational purposes only and is believed to be accurate, but not warranted. Please go to web to make sure you have the latest Rev.

DATE	REVISION	CHANGE
9/23/09	FN6916.0	Initial Release.

---

## Products

Intersil Corporation is a leader in the design and manufacture of high-performance analog semiconductors. The Company's products address some of the industry's fastest growing markets, such as, flat panel displays, cell phones, handheld products, and notebooks. Intersil's product families address power management and analog signal processing functions. Go to [www.intersil.com/products](http://www.intersil.com/products) for a complete list of Intersil product families.

\*For a complete listing of Applications, Related Documentation and Related Parts, please see the respective device information page on intersil.com: [ISL1539A](http://www.intersil.com/ISL1539A)

To report errors or suggestions for this datasheet, please go to [www.intersil.com/askourstaff](http://www.intersil.com/askourstaff)

FITs are available from our website at <http://rel.intersil.com/reports/search.php>

# Package Outline Drawing

## L24.4x5B

### 24 LEAD QUAD FLAT NO-LEAD PLASTIC PACKAGE

Rev 0, 10/06

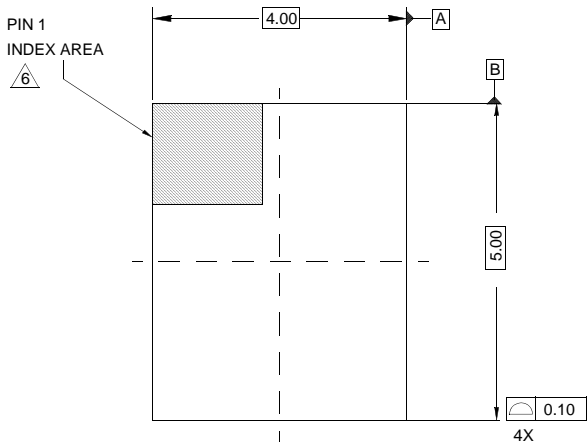

TOP VIEW

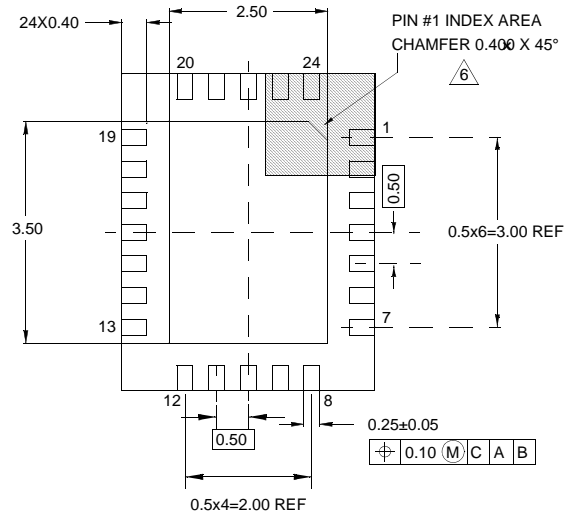

BOTTOM VIEW

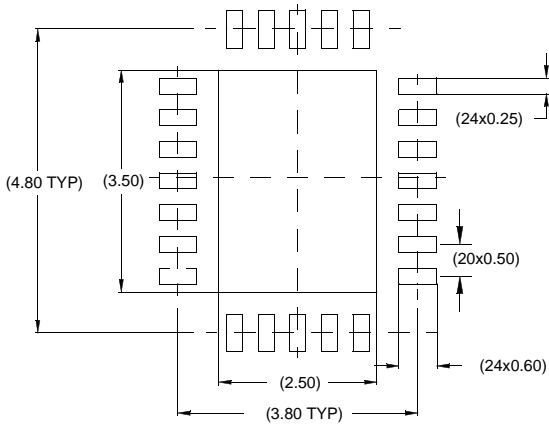

TYPICAL RECOMMENDED LAND PATTERN

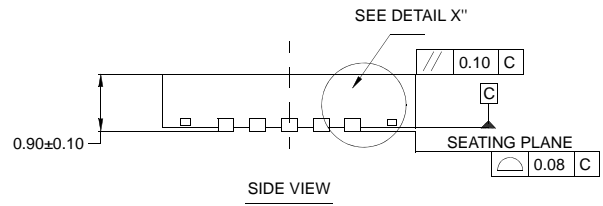

SIDE VIEW

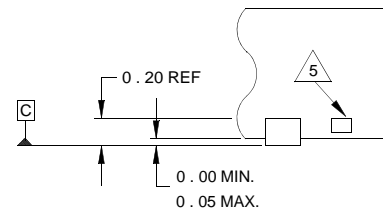

DETAIL "X"

#### NOTES:

- Dimensions are in millimeters.  
Dimensions in ( ) for Reference Only.
- Dimensioning and tolerancing conform to AMSE Y14.5m-1994.
- Unless otherwise specified, tolerance : Decimal ± 0.05
- Dimension b applies to the metallized terminal and is measured between 0.20mm and 0.30mm from the terminal tip.
- Tiebar shown (if present) is a non-functional feature.
- The configuration of the pin #1 identifier is optional, but must be located within the zone indicated. The pin #1 identifier may be either a mold or mark feature.

HTSSOP (Heat-Sink TSSOP) Family

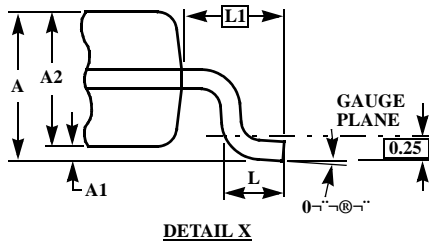
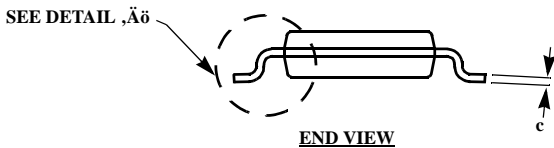
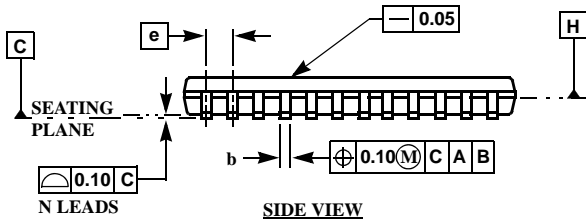
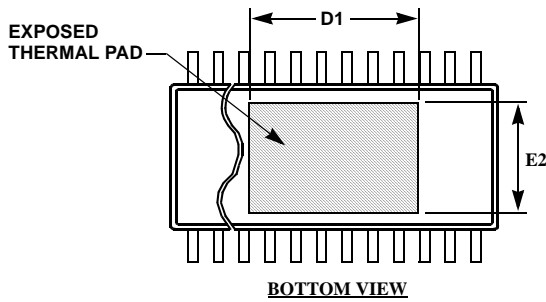
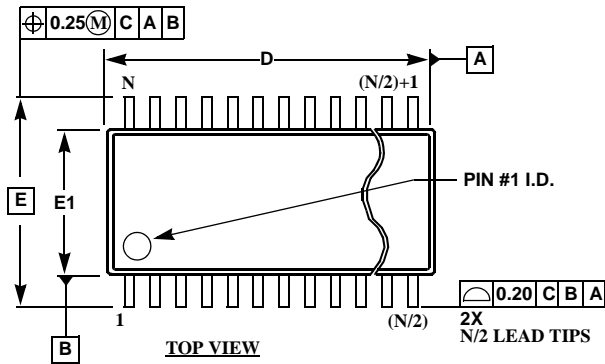

MDP0048

HTSSOP (HEAT-SINK TSSOP) FAMILY

SYMBOL	MILLIMETERS					TOLER- ANCE
	14 LD	20 LD	24 LD	28 LD	38 LD	
A	1.20	1.20	1.20	1.20	1.20	Max
A1	0.075	0.075	0.075	0.075	0.075	±0.075
A2	0.90	0.90	0.90	0.90	0.90	+0.15/-0.10
b	0.25	0.25	0.25	0.25	0.22	+0.05/-0.06
c	0.15	0.15	0.15	0.15	0.15	+0.05/-0.06
D	5.00	6.50	7.80	9.70	9.70	±0.10
D1	3.2	4.2	4.3	5.0	7.25	Reference
E	6.40	6.40	6.40	6.40	6.40	Basic
E1	4.40	4.40	4.40	4.40	4.40	±0.10
E2	3.0	3.0	3.0	3.0	3.0	Reference
e	0.65	0.65	0.65	0.65	0.50	Basic
L	0.60	0.60	0.60	0.60	0.60	±0.15
L1	1.00	1.00	1.00	1.00	1.00	Reference
N	14	20	24	28	38	Reference

Rev. 3 2/07

NOTES:

1. Dimension "D" does not include mold flash, protrusions or gate burrs. Mold flash, protrusions or gate burrs shall not exceed 0.15mm per side.
2. Dimension "E1" does not include interlead flash or protrusions. Interlead flash and protrusions shall not exceed 0.25mm per side.
3. Dimensions "D" and "E1" are measured at Datum Plane H.
4. Dimensioning and tolerancing per ASME Y14.5M-1994.

For additional products, see [www.intersil.com/product\\_tree](http://www.intersil.com/product_tree)

Intersil products are manufactured, assembled and tested utilizing ISO9000 quality systems as noted in the quality certifications found at [www.intersil.com/design/quality](http://www.intersil.com/design/quality)

Intersil products are sold by description only. Intersil Corporation reserves the right to make changes in circuit design, software and/or specifications at any time without notice. Accordingly, the reader is cautioned to verify that data sheets are current before placing orders. Information furnished by Intersil is believed to be accurate and reliable. However, no responsibility is assumed by Intersil or its subsidiaries for its use; nor for any infringements of patents or other rights of third parties which may result from its use. No license is granted by implication or otherwise under any patent or patent rights of Intersil or its subsidiaries.

For information regarding Intersil Corporation and its products, see [www.intersil.com](http://www.intersil.com)