



BG-UM44-100M-KIT

**18Gbps 4x4 HDBaseT (100M) Matrix
with ARC Function**



User Manual

Thank you for purchasing this product

For optimum performance and safety, please read these instructions carefully before connecting, operating, or adjusting this product. Please keep this manual for future reference.

Surge protection device recommended

This product contains sensitive electrical components that may be damaged by electrical spikes, surges, electric shock, lightning strikes, etc. Use of surge protection systems is highly recommended in order to protect and extend the life of your equipment.

Table of Contents

1. Introduction	1
2. Features	1
3. Package Contents	2
4. Specifications	2
5. Operation Controls and Functions	4
5.1. Matrix Panel	4
5.2. HDBaseT Receiver Panel.....	6
6. IR Remote.....	7
7. IR Control System	9
8. IR Cable Pin Assignment.....	11
9. EDID Management	11
10. Matrix Audio and RS-232 Introduction	13
11. Web GUI User Guide	14
12. RS-232 Control Command.....	22
13. Application Example	29
14. Warranty.....	30
15. Mission Statement.....	30

1. Introduction

The 18Gbps 4x4 HDBaseT (100M) Matrix can connect four HDMI sources to eight displays. It features four HDMI outputs and each HDMI output is mirrored to provide a CAT-Cable output which runs simultaneously. HDBaseT output can extend video transmission distance up to 328ft / 100m via a single cat5e/6/7 cable and the resolution is up to 4K@60Hz 4:4:4.

The product supports IR matrix and Audio matrix. With ARC function, it can return the audio signal from HDMI or HDBaseT display device to coaxial audio and analog audio outputs using Web GUI or ASCII code control. It can also extract the audio signal from HDMI source device to analog audio and coaxial audio outputs using Web GUI or ASCII code control. Moreover, the product supports bi-directional IR and RS-232 function. The product features an intuitive set of front panel controls with OLED screen as well as control via IR remote, RS-232, LAN, and Web GUI.

2. Features

- ☆ HDCP 2.2 and HDCP 1.4 compliant
- ☆ 4 HDMI inputs, 4 HDMI & HDBaseT mirrored outputs
- ☆ HDMI ports transmit 18Gbps lossless uncompressed video bandwidth
- ☆ Support 18Gbps lossless compressed HDBaseT signal transmission
- ☆ Support 4K->1080P Down Scaler
- ☆ Dolby Vision, HDR10+, HLG
- ☆ HDBaseT output can extend video transmission distance up to 328ft / 100 meters via a single cat5e/6/7 cable and the resolution is up to 4K@60Hz 4:4:4.
- ☆ HDMI audio pass-through up to 7.1CH HD audio (LPCM, Dolby TrueHD and DTS-HD Master Audio)
- ☆ Support ARC function on local HDMI and HDBaseT output ports
- ☆ IR matrix and Audio matrix
- ☆ Smart EDID management
- ☆ 24V POC on all HDBaseT ports
- ☆ Control via front panel buttons, IR remote, RS-232, LAN, and Web GUI

3. Package Contents

- ① 1x 4x4 HDMI and HDBaseT Matrix Switch
- ② 4x HDBaseT Receiver
- ③ 1x Matrix IR Remote
- ④ 1x 100~240V AC 50/60Hz Power cable
- ⑤ 1x RS-232 serial cable (1.5 meters, male to female head)
- ⑥ 8x 3-pin Phoenix Connector
- ⑦ 5x IR Blaster cable (1.5 meters)
- ⑧ 6x 20~60KHz IR Receiver cable (1.5 meters)
- ⑨ 10x Mounting Ear (Matrix and Receiver)
- ⑩ 1x User Manual

4. Specifications

Technical	
HDCP Compliance	HDCP 2.2 and HDCP 1.4
Video Bandwidth	18Gbps
Video Resolution	Up to 4K2K@50/60Hz (4:4:4)
Color Space	RGB, YCbCr 4:4:4/4:2:2/4:2:0
Color Depth	12-bit (4K), 16-bit (1080P)
HDMI Audio Formats (Pass-through)	PCM2.0/5.1/7.1CH, Dolby Digital/Plus/EX, Dolby True HD, DTS, DTS-EX, DTS-96/24, DTS High Res, DTS-HD Master Audio, DSD
Coax Audio Formats	PCM 2.0, Dolby Digital / Plus, DTS,
L/R Audio Formats	PCM2.0
HDR formats	4:4:4, 4:2:2, 4:2:0 (10, 12bit deep color) HDR10, HDR10+, Dolby Vision, HLG
Infrared	20KHz ~ 60KHz
ESD Protection	Human-body Model: ±8kV (Air-gap discharge), ±4kV (Contact discharge)
Connection	
Matrix	
Input Ports	4×INPUT [HDMI Type A, 19-pin female] 6×IR INPUT [3.5mm Stereo Mini-jack] 2×Stereo Audio [3.5mm Stereo Mini-jack B] 1×SPDIF(OPTICAL) 1×SPDIF(COAX)

Output Ports	4xHDMI OUTPUT [HDMI Type A, 19-pin female] 4xHDBaseT port [RJ45] 5xIR OUTPUT [3.5mm Stereo Mini-jack] 4xRS-232 [3-pin Phoenix connector] 4xSPDIF(COAX) 4xStereo Audio [3.5mm Stereo Mini-jack] 1xLAN [RJ45]		
Control Ports	1xTCP/IP [RJ45] 1xRS-232 [D-Sub 9]		
HDBaseT Receiver			
Input Ports	1xHDBaseT IN [RJ45] 1xIR IN [3.5mm Stereo Mini-jack]		
Output Ports	1xHDMI OUT [HDMI Type A, 19-pin female] 1xIR OUT [3.5mm Stereo Mini-jack]		
Control Ports	1xSERVICE [Micro USB, Update port] 1xRS-232 [Phoenix jack] 2xLAN [RJ45]		
Mechanical			
Housing	Metal Enclosure		
Color	Black		
Dimensions	TX: 440mm (W)×274mm (D)×45mm (H) RX: 163mm (W)×90.3mm (D)×18mm (H)		
Weight	TX: 3977g, RX: 392g		
Power Supply	AC 100 - 240V 50/60Hz		
Power Consumption	70W (Max)		
Operating Temperature	0°C ~ 40°C / 32°F ~ 104°F		
Storage Temperature	-20°C ~ 60°C / -4°F ~ 140°F		
Relative Humidity	20~90% RH (non-condensing)		
Resolution / Distance	4K60 - Feet / Meters		
CAT5e/6/7	328ft / 100M		
Resolution / Cable length	4K60 - Feet / Meters	4K30 - Feet / Meters	1080P60 - Feet / Meters
HDMI IN / OUT	16ft / 5M	32ft / 10M	50ft / 15M
The use of "Premium High Speed HDMI" cable is highly recommended.			

5. Operation Controls and Functions

5.1 Matrix Panel

Front Panel

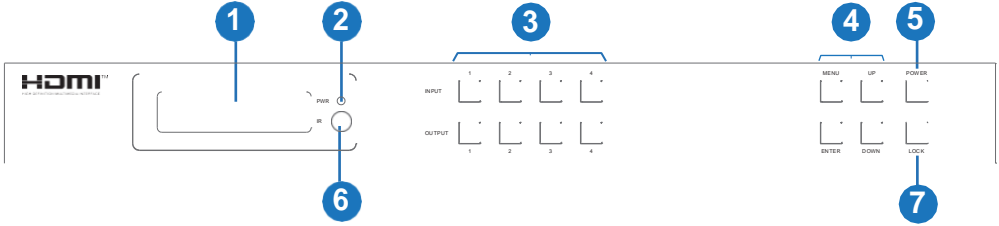

NO.	Name	Function Description
1	OLED screen	Display matrix switching status, input / output port, EDID, Baud rate, IP Address.
2	Power LED	The LED will illuminate in green when the product is connected to power supply, and red when the product is on standby.
3	Input / Output buttons	You need to press an output button (1~4) firstly and then press an input button (1~4) to select the corresponding input source for the output port.
4	MENU / ENTER / UP /DOWN	<p>①EDID Check: On the initial OLED display screen, press “MENU” button to enter the Matrix switching state interface, then press “UP/DOWN” button to check the current EDID information of each HDMI input port.</p> <p>②EDID setting: On the initial OLED display screen, press “MENU” button to enter the EDID setting interface, press “UP/DOWN” button to select the required EDID and press the “ENTER” button. A prompt “copy to input :” will appear. Then press “UP/DOWN” button to select the input port you need to set, and press “ENTER” button again to confirm.</p> <p>③Baud rate setting: On the initial OLED display screen, press “MENU” button to enter the Baud rate interface, and press “UP/DOWN” button to select the required Baud rate, finally press the “ENTER” button to confirm the setting.</p> <p>④IP Address Check: On the initial OLED display screen, press “MENU” button to enter the IP interface, then press “UP/DOWN” button to check the current IP address. Pressing the “MENU” button again will return to the initial OLED display status.</p>
5	POWER button	Long press the POWER button for 3 seconds to enter the standby mode, then short press it to wake up the device.
6	IR Window	IR receiver window, it only receives the IR remote signal from this product.
7	LOCK button	Short press the LOCK button to lock front panel buttons (Except the power button); Press it again to unlock.

Rear Panel

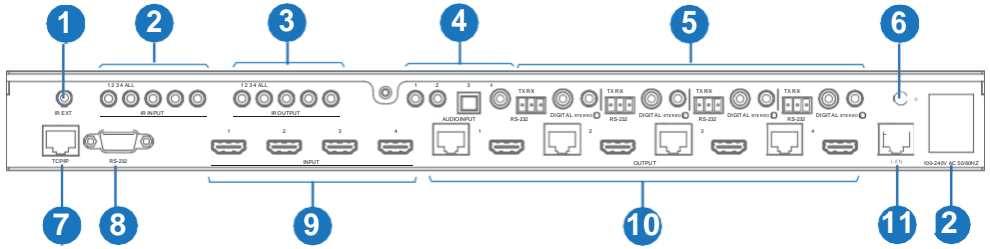

No.	Name	Function Description
1	IR EXT	If the IR receiver window of the unit is blocked or the unit is installed in a closed area out of infrared line of sight, the IR receiver cable can be inserted to the "IR EXT" port to receive the IR remote signal.
2	IR INPUT ports	Connect to IR receiver cable, the IR receive signal will emit to "IR OUT" port of the HDBaseT Receiver.
3	IR OUTPUT ports	Connect to IR blaster cable, the IR emit signal is from "IR IN" port of the HDBaseT Receiver.
4	AUDIO IN ports	L/R, optical and coaxial audio input ports, connect to external audio source device such as PC or DVD.
5	RS-232 port	Connect to a PC or control system by 3-pin phoenix connector serial cable to transmit command between the Matrix and HDBaseT Receiver.
	DIGITAL port	Coaxial audio output port, connect to audio output device such as audio amplifier via a coaxial cable.
	STEREO port	Stereo audio output port, connect to an amplifier or speaker via a 3.5mm audio cable.
6	GND	The housing is connected to the ground.
7	TCP/IP port	This port is the link port for TCP/IP control and connect to an active Ethernet link by an RJ45 cable.
8	RS-232 port	Connect to a PC or control system by D-Sub 9-pin cable to control the Matrix.
9	INPUT ports (1-4)	HDMI input ports, connect to HDMI source device such as DVD or PS4 with an HDMI cable.
10	OUTPUT ports (1-4)	HDBaseT ports, connect to HDBaseT Receiver via CAT cable.
		HDMI output ports, connect to HDMI display device such as TV or monitor with an HDMI cable.
11	LAN	This port is connected to a router and the LAN port of the HDBaseT Receiver can connect Internet device such as PC or laptop.
12	POWER input	Connect to 100~240V AC 50/60Hz power cable.

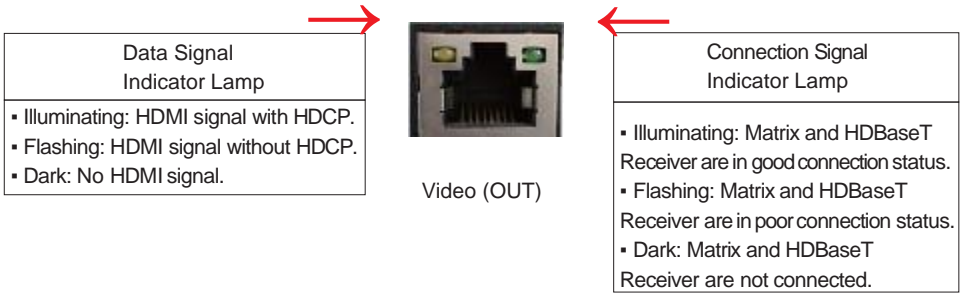

5.2 HDBaseT Receiver Panel

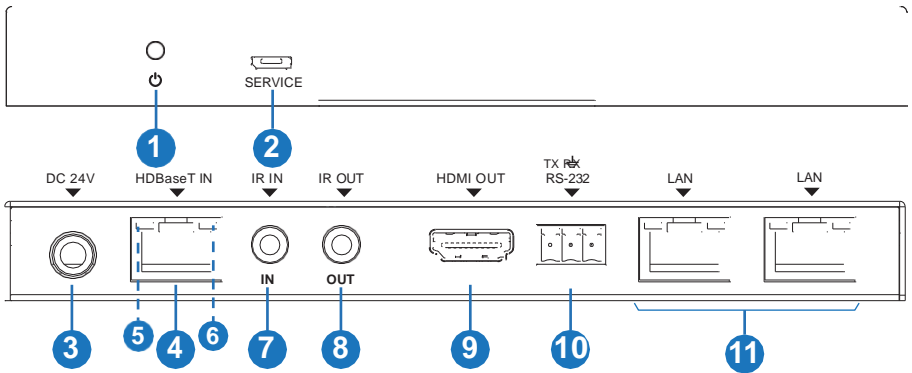

No.	Name	Function Description
1	POWER LED	Power LED indicator, LED will illuminate when the device is connected to a power supply.
2	SERVICER port	Firmware update port
3	DC 24V	Plug the DC 24V/1A power cord into this port and connect the adapter to AC wall outlet. Note: The Matrix supports POC function, so the Receiver doesn't need a power supply when HDBaseT IN port is connected to HDBaseT port of the Matrix.
4	HDBaseT IN port	Connect to HDBaseT output port of the Matrix with CAT cable.
5	Connection Signal Indicator Lamp (Green)	<ul style="list-style-type: none"> ▪ Illuminating: Matrix and Receiver are in good connection status. ▪ Flashing: Matrix and Receiver are in poor connection status. ▪ Dark: Matrix and Receiver are not connected.
6	Data Signal Indicator Lamp (Orange)	<ul style="list-style-type: none"> ▪ Illuminating: HDMI signal with HDCP. ▪ Flashing: HDMI signal without HDCP. ▪ Dark: No HDMI signal.

No.	Name	Function Description
7	IR IN	Connect to IR receiver cable, the IR signal will emit to IR OUT port of the Matrix.
8	IR OUT	Connect to IR blaster cable, the IR emit signal is from IR IN port of the Matrix.
9	HDMI OUT port	HDMI output port, connect to HDMI display device such as TV or monitor with HDMI cable.
10	RS-232 port	Connect to a PC or control system by 3-pin phoenix connector cable to transmit command between the Matrix and HDBaseT Receiver.
11	LAN ports	Connect Ethernet cables to these ports to provide a wired Ethernet connection to local devices.

6. IR Remote

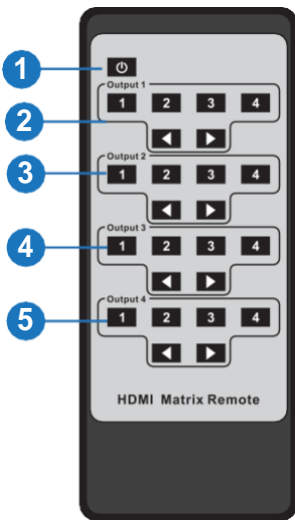

- ① **Power on or Standby:** Power on the Matrix or set it to standby mode.
 - ② **Output 1:** Press 1\2\3\4 button to select input source to HDMI OUTPUT 1.
 - ③ **Output 2:** Press 1\2\3\4 button to select input source to HDMI OUTPUT 2.
 - ④ **Output 3:** Press 1\2\3\4 button to select input source to HDMI OUTPUT 3.
 - ⑤ **Output 4:** Press 1\2\3\4 button to select input source to HDMI OUTPUT 4.
- ◀ ▶ : Select the last or next input source button.

The Matrix input and output sources can be selected by using the IR remote. There are two ways to receive the IR remote signal.

Method 1: The IR window accepts the IR remote signal. When using the IR remote, the furthest distance is 7 meters and the angle is $\pm 45^\circ$. The diagram is shown as below:

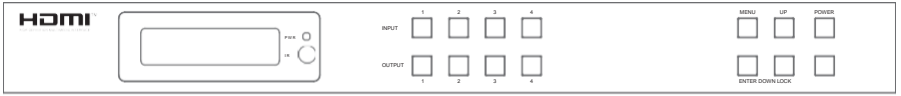

IR remote of the Matrix

The second method: If the IR receiver window of the Matrix is blocked or the Matrix is installed in a closed area out of infrared line of sight, the IR receiver cable can be inserted to the "IR EXT" port to receive the IR remote signal. The furthest distance of using the IR remote is 7 meters and the IR remote is directly faced to the IR receiver head. The diagram is shown as below.



IR remote of the Matrix



Machine Cabinet

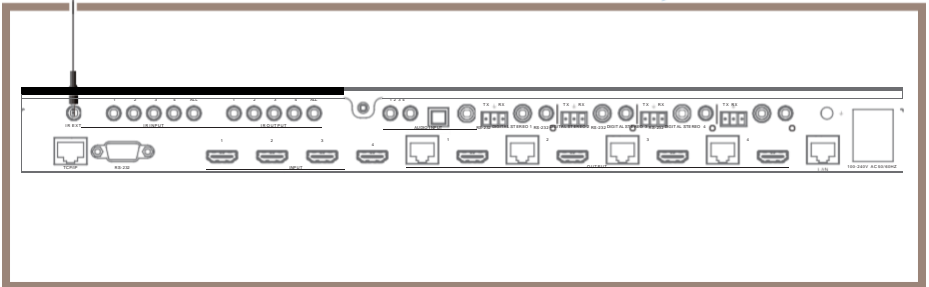

7. IR Control System

The product is not only a matrix switch but also an extender. It supports bi-directional IR control. When the matrix is connected to a HDBaseT Receiver through Cat 5e/6/7 cable, you can control the remote display device (HDBaseT) or input source device (Matrix) through IR signal transmission. The IR signal transmission method is different using the method from Matrix (local) to HDBaseT Receiver (remote) and from HDBaseT Receiver (remote) to Matrix (local).

At the Matrix end (Local end): the IR signal is one-to-one transmission. It means that the IR INPUT 1 port signal of the Matrix will emit to IR output port of the HDBaseT Receiver 1 and the IR INPUT 2 port signal of the Matrix will emit to IR output port of the HDBaseT Receiver 2 etc. It doesn't follow the video switch to change. IR All input port signal of the Matrix will emit to all IR output port of HDBaseT receiver simultaneously. Please see the following connection diagram.

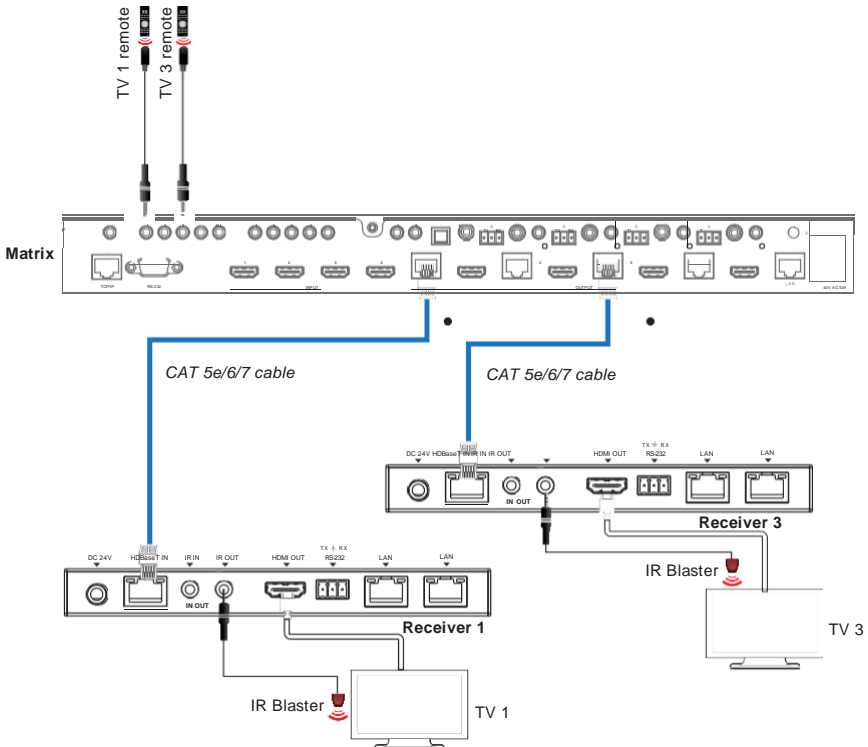

Figure 1: IR connection diagram (Matrix end)

At HDBaseT receiver (Remote end): IR signal follows video switch to change. For example, the HDMI output signal on the HDBaseT Receiver 1 is from the HDMI 2 input port, so IR input signal of the HDBaseT Receiver 1 will emit to IR OUTPUT 2 port of the Matrix. The HDMI output signal on the HDBaseT Receiver 3 is from the HDMI 4 input port. Then, IR input signal of the HDBaseT Receiver 3 will emit to IR OUTPUT 4 port of the Matrix etc. Any of HDBaseT Receiver's IR IN signal can output from IR ALL port of the Matrix and the IR OUTPUT ALL signal of the Matrix depends on your IR remote of source device. Please see the following connection diagram.

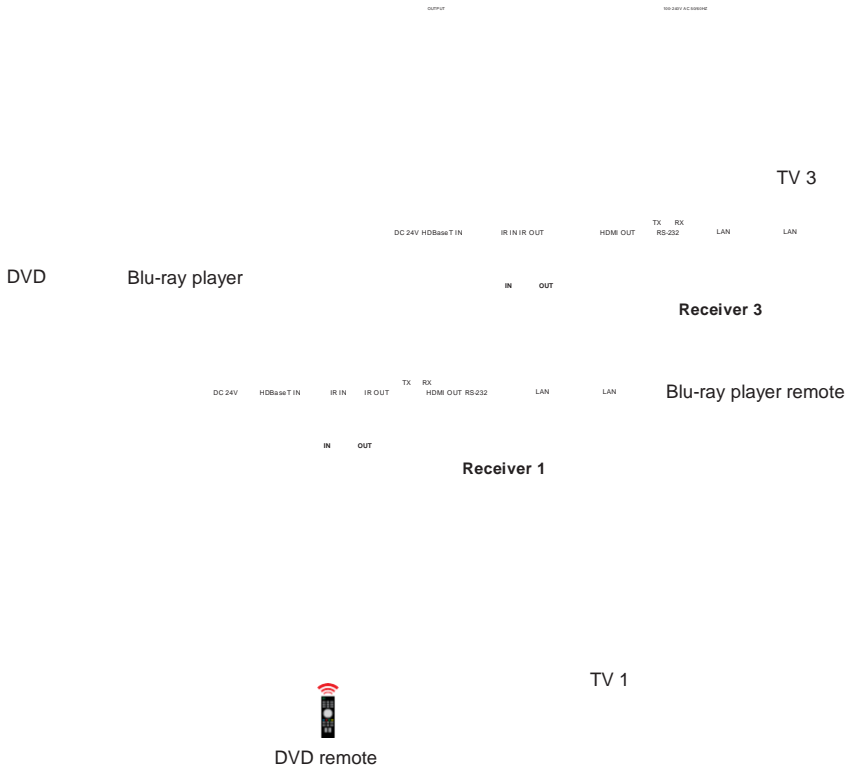
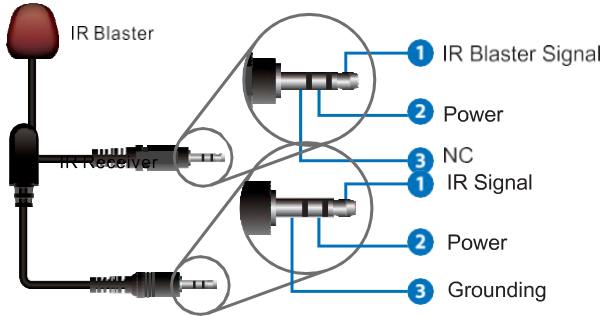

Figure 2: IR connection diagram (HDBaseT Receiver end)

8. IR Cable Pin Assignment



9. EDID Management

This Matrix has 21 factory defined EDID settings, 2 user-defined EDID modes and 8 copy EDID modes. You can select defined EDID mode or copy EDID mode to input port through on-panel button, ASCII control or Web GUI.

On-panel button operation: On the initial OLED display screen, press “MENU” button to enter the EDID setting interface, press “UP/DOWN” button to select the required EDID, and press the “ENTER” button. A prompt “copy to input :” will appear. Then press “UP/DOWN” button to select the input port you need to set, and press “ENTER” button again to confirm this operation.

RS-232 control operation: Connect the Matrix to PC with a serial cable, then open a Serial Command tool on PC to send ASCII command “s edid in x from z!” to set EDID. For details, please refer to “EDID Setting” in the ASCII command list of “12. RS-232 Control Command”.

Web GUI Operation: Please check the EDID management in the “Input page” of “11. Web GUI User Guide”.

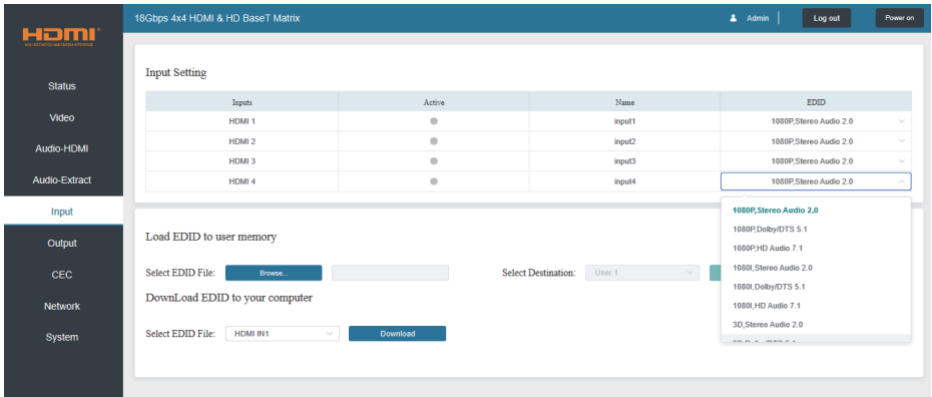

The defined EDID setting list of the product is shown as below:

EDID Mode	EDID Description
1	1080p, Stereo Audio 2.0
2	1080p, Dolby/DTS 5.1
3	1080p, HD Audio 7.1
4	1080i, Stereo Audio 2.0
5	1080i, Dolby/DTS 5.1
6	1080i, HD Audio 7.1
7	3D, Stereo Audio 2.0
8	3D, Dolby/DTS 5.1
9	3D, HD Audio 7.1
10	4K2K30_444, Stereo Audio 2.0
11	4K2K30_444, Dolby/DTS 5.1
12	4K2K30_444, HD Audio 7.1
13	4K2K60_420, Stereo Audio 2.0
14	4K2K60_420, Dolby/DTS 5.1
15	4K2K60_420, HD Audio 7.1
16	4K2K60_444, Stereo Audio 2.0
17	4K2K60_444, Dolby/DTS 5.1
18	4K2K60_444, HD Audio 7.1
19	4K2K60, Stereo Audio 2.0 HDR
20	4K2K60, Dolby/DTS 5.1 HDR
21	4K2K60, HD Audio 7.1HDR
22	User1
23	User2
24~27	Copy from HDMI OUT 1~4
28~31	Copy from HDBT OUT 1~4

10. Matrix Audio and RS-232 Introduction

The Matrix supports coaxial and analog audio output. The audio signal follows HDBaseT and HDMI output port. It supports one-to-one transmission. For example, the OUTPUT 1 port audio signal follows HDBaseT and HDMI 1 port, the OUTPUT 2 port audio signal follows HDBaseT and HDMI 2 port etc.

If HDMI ARC switch and HDBaseT ARC switch are turned on by ASCII command, the coaxial and analog audio output can be the returned HDMI or HDBaseT display device's audio, the external audio source, or the extracted HDMI source device audio.

Note: During multi-audio, 3.5 audio has no audio output.

The RS-232 channel is also one-to-one transmission. For example, the RS-232 port of the OUTPUT 1 at Matrix end follows the RS-232 port at HDBaseT Receiver 1, The RS-232 port of the OUTPUT 3 at Matrix end follows the RS-232 port at HDBaseT Receiver 3 etc. Please see the following connection diagram.

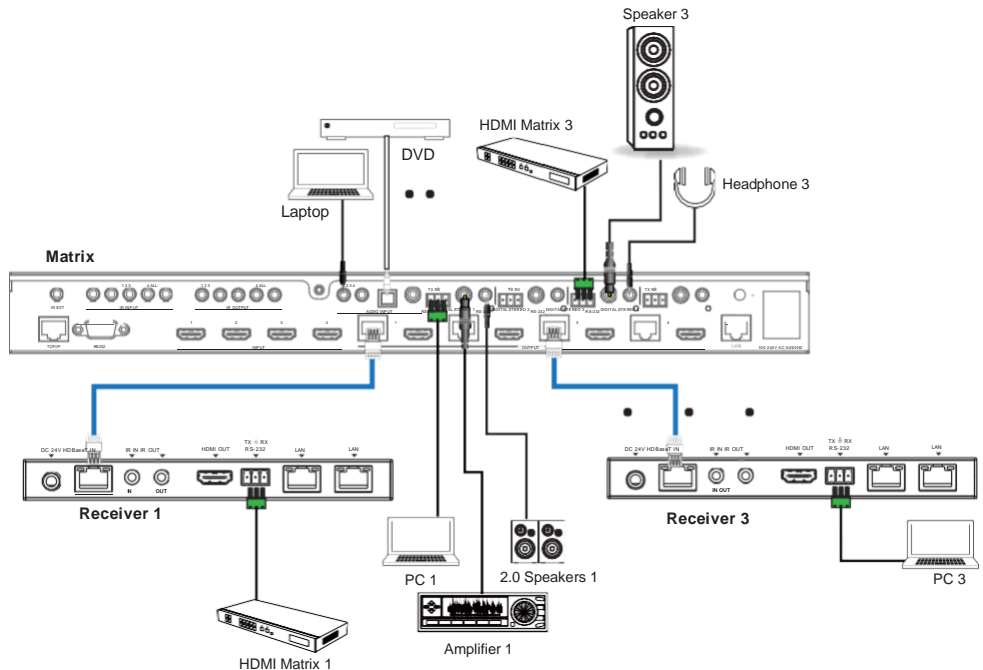

RS-232 port:

- The RS-232 port of Matrix and receiver is a two-way channel (you can connect PC at Matrix or receiver and connect HDMI Matrix at receiver or Matrix).
- The RS-232 port of Matrix and receiver is one-to-one transmission (For example: RS-232 of OUTPUT 2 at Matrix to RS-232 of HDBaseT Receiver 2).
- You can use Upper computer or control software of the HDMI Matrix on the computer to control remote HDMI Matrix.

Figure 3: Audio and RS-232 connection diagram

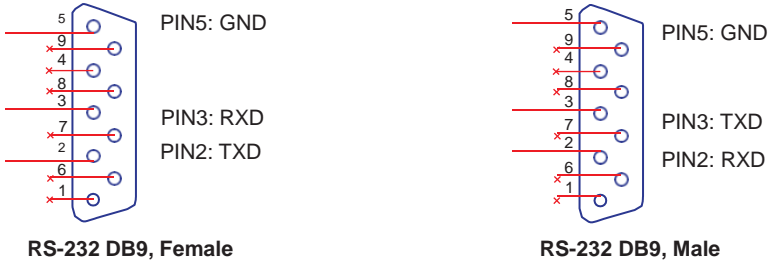
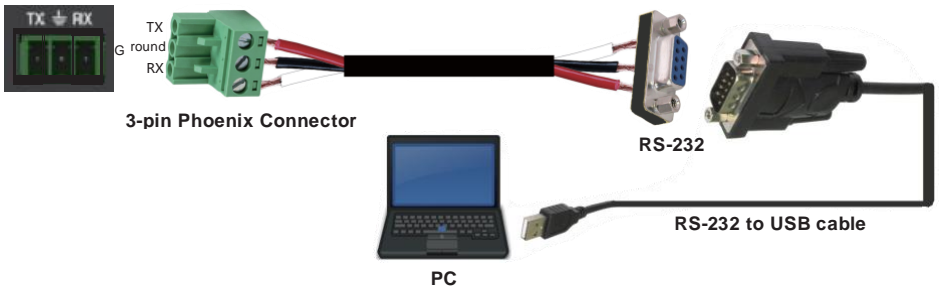

Figure 4: 3-pin phoenix connector to USB

11. Web GUI User Guide

The Matrix can be controlled by Web GUI. The operation method is shown as below:

Step 1: Get the current IP Address.

The default IP address is 192.168.1.100. You can get the current Matrix IP address in two ways:

The first way: You can get the IP address via panel buttons. On the initial OLED display, press “MENU” button to enter the Matrix switching state interface, then press “UP/DOWN” button to check the current IP address.

The second way: You can get the IP address via RS-232 control. Send the ASCII command “ r ipconfig!” through a Serial Command tool, then you’ll get the feedback information as shown below:

```

IP Mode: DHCP
IP:192.168.62.109
Subnet Mask:255.255.255.0
Gateway:192.168.62.1
TCP/IP port:8000
Telnet port:23
Mac address:6c-df-fb-0c-b3-8e

```

IP:192.168.62.109 in the above figure is the IP Address of the Matrix (the IP address is variable, depending on what the specific machine returns).

For the details of RS-232 control, please refer to “12. RS-232 Control Command”.

Step 2: Connect the TCP/IP port of the Matrix to a PC with an UTP cable, and set the IP address of the PC to be in the same network segment with the Matrix.

Step 3: Input the IP address into your browser on the PC to enter Web GUI page.

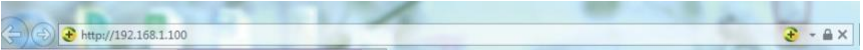

After entering the Web GUI page, there will be a Login page, as shown below:



Select the Username from the list and enter the password. The default passwords are:

Username	User	Admin
Password	user	admin

After entering the password, click the “LOGIN” button and the following Status page will appear.

■ Status Page

The Status page provides basic information about the installed firmware version and the network settings of the device.

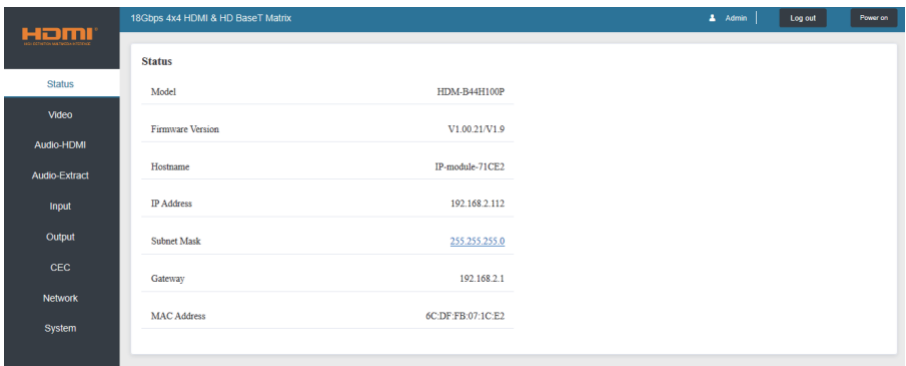

■ Video Page

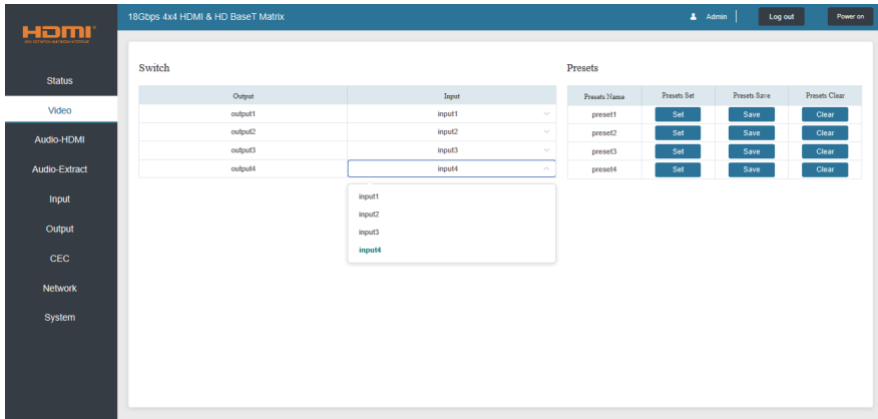

You can do the following operations on the Video page:

- ① **Output:** The current device's OUTPUT port. You can select signal source for it.
- ② **Input:** You can click the drop-down menu to select signal source for the corresponding OUTPUT port .
- ③ **Presets Name:** You can name the current scene with maximum length of 12 characters (Chinese name is unsupported).
- ④ **Presets Set:** You can restore the settings of the last saved audio-video matrix switching relationship.
- ⑤ **Presets Save:** You can save audio-video matrix switching relationship.
- ⑥ **Presets Clear:** You can clear the saved audio-video matrix switching relationship.

■ Audio-HDMI Page

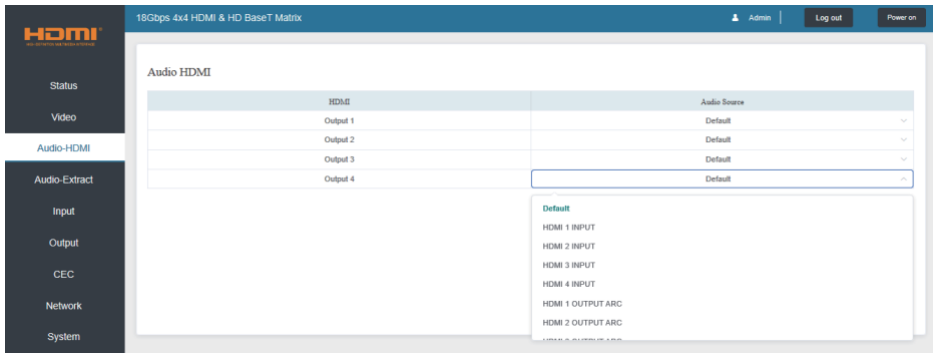

You can do the following operations on the Audio-HDMI page:

- ① **HDMI:** Audio channel of the current Output.
- ② **Audio Source:** The input source of the current audio channel. You can switch the input source by clicking the corresponding drop-down box to select the desired input source.

■ Audio-Extract Page

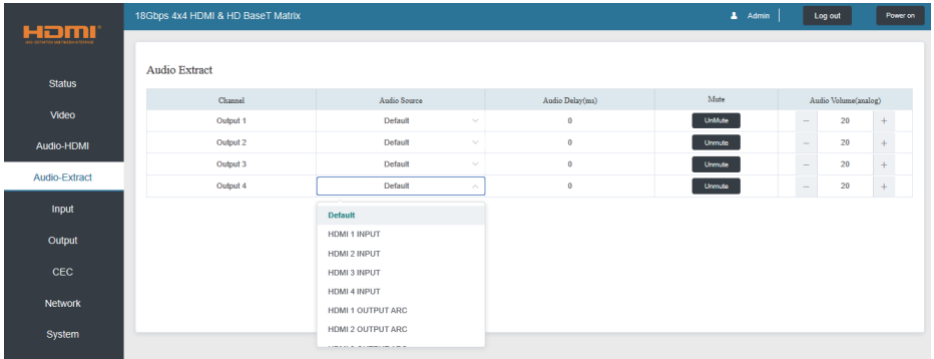

You can do the following operations on the Audio-Extract page:

- ① **Channel:** Audio output channel for coaxial audio or analog audio.
- ② **Audio Source:** The input source of the current audio channel. You can switch the input source by clicking the corresponding drop-down box to select the desired input source.
- ③ **Audio Delay:** Set the output delay. You can modify it by entering the corresponding value (range: 0 ~ 300) in the input box.
- ④ **Mute:** You can mute or unmute the audio output channel by clicking the blue button.
- ⑤ **Audio Volume(Analog):** You can set the volume value (range: 0~30) for the analog output channel by clicking "-" / "+" or entering the value in the input box.

■ Input Page

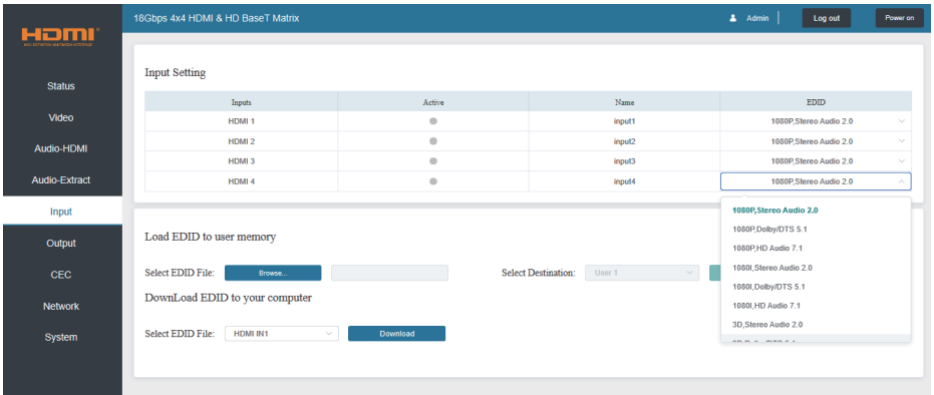

You can do the following operations on the Input page:

- ① **Inputs:** Input channel of the device.
- ② **Active:** It indicates whether the channel is connected to a signal source.
- ③ **Name:** The input channel's name. You can modify it by entering the corresponding name (max length: 12 characters) in the input box (Chinese name is unsupported).
- ④ **EDID:** You can set the current channel's EDID. The specific operation is as follows:

Set EDID for the User

Click the “Browse” button, then select the bin file. If you select the wrong EDID file, there will be a prompt, as shown in the following figure:

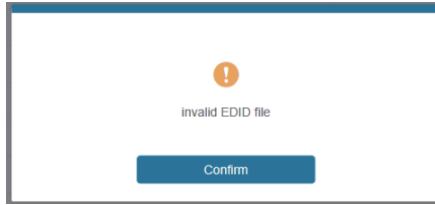

Make sure to select the correct file, then you can check the name of the selected file. Select “User 1” or “User 2”, then click “Upload”. After successful setting, it will prompt as follows:

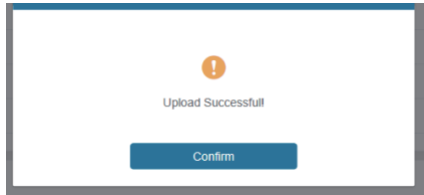

Download the EDID File for the Corresponding Input Channel

Click the drop-down box of “Select EDID File” to select the corresponding input channel. Then click “Download” to download the corresponding EDID file.

■ Output Page

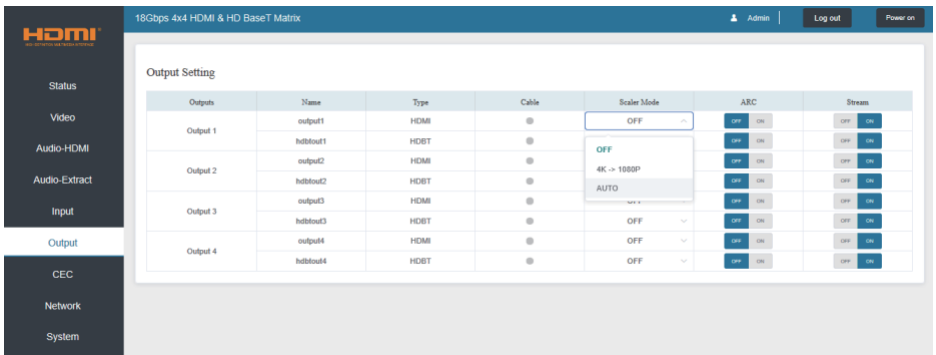

Outputs	Name	Type	Cable	Scale Mode	ARC	Stream
Output 1	output1	HDMI	⊗	OFF	OFF ON	OFF ON
	hdltou1	HDBT	⊗		OFF ON	OFF ON
Output 2	output2	HDMI	⊗	OFF	OFF ON	OFF ON
	hdltou2	HDBT	⊗	4K @ 1080P	OFF ON	OFF ON
Output 3	output3	HDMI	⊗	AUTO	OFF ON	OFF ON
	hdltou3	HDBT	⊗	OFF	OFF ON	OFF ON
Output 4	output4	HDMI	⊗	OFF	OFF ON	OFF ON
	hdltou4	HDBT	⊗	OFF	OFF ON	OFF ON

You can do the following operations on the Output page:

- ① **Outputs:** Output channel of the device.
- ② **Name:** The current output channel’s name. You can modify it by entering the corresponding name (max length: 12 characters) in the input box (Chinese name is unsupported).
- ③ **Type:** The current output channel’s type (HDMI or HDBT).
- ④ **Cable:** It indicates the connection status of output ports. When the output port is connected to the display, it shows green, otherwise, it shows gray.

- ⑤ **Scalar Mode:** Set the current output resolution mode.
- ⑥ **ARC:** Turn on/off the ARC function.
- ⑦ **Stream:** Turn on/off the output stream.

■ CEC Page

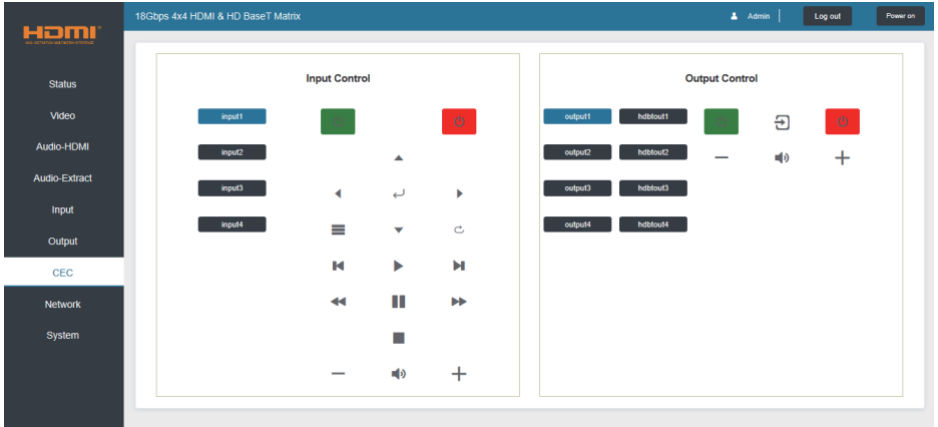

You can perform CEC management on this page:

- ① **Input Control:** You can control the operation of each input source by pressing the icons on the page.
- ② **Output Control:** You can control the operation of each display, such as power on/off, volume +/-, active source switching.

■ Network Page

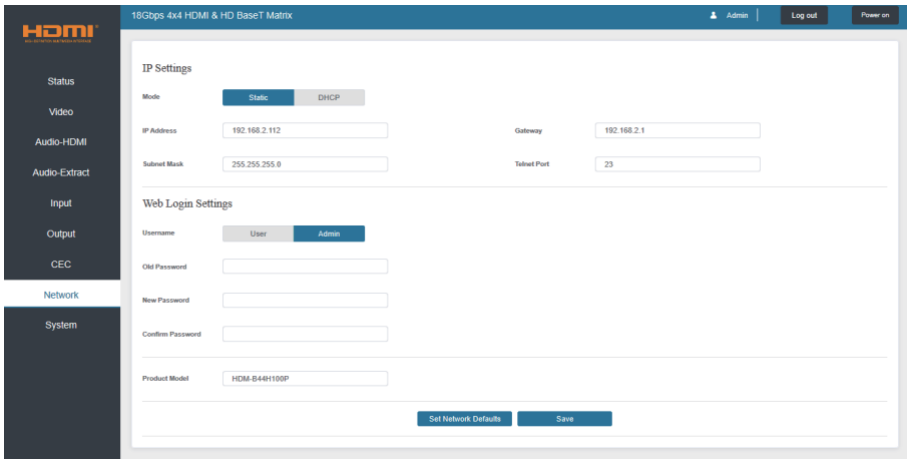

Set the Default Network

Click “Set Network Defaults” button, there will be a prompt, as shown in the following figure:

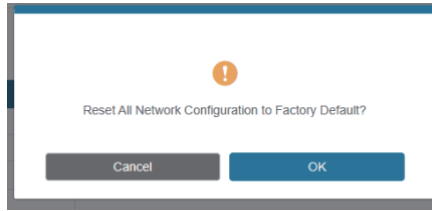

Click “OK” to search the IP Address again, as shown in the following figure:

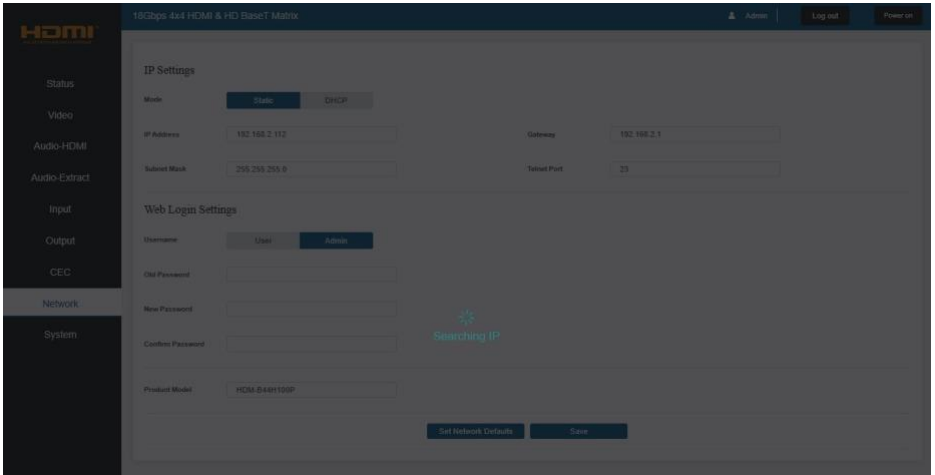

After searching is completed, it will switch to the login page, the default network setting is completed.

Modify User Password

Click the “User” button, enter the correct Old Password, New Password, and Confirm Password, then click “Save”. After successful modification, there will be a prompt, as shown in the following figure:

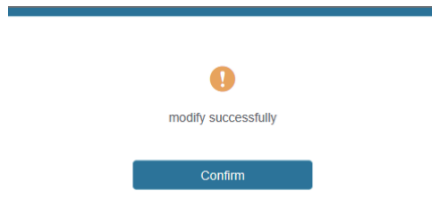

Note: Input rules for changing passwords:

- (1) The password can't be empty.
- (2) New Password can't be the same as Old Password.
- (3) New Password and Confirm Password must be the same.

Modify Network Setting

Modify the Mode/IP Address/Gateway/Subnet Mask/Telnet Port as required, click “Save” to save the settings, then it will come into effect.

After modification, if the Mode is “Static”, it will switch to the corresponding IP Address; if the Mode is “DHCP”, it will automatically search and switch to the IP Address assigned by the router.

IP Settings

Mode	<input checked="" type="radio"/> Static	<input type="radio"/> DHCP
IP Address	<input type="text" value="192.168.2.112"/>	Gateway <input type="text" value="192.168.2.1"/>
Subnet Mask	<input type="text" value="255.255.255.0"/>	Telnet Port <input type="text" value="23"/>

■ System Page

The screenshot shows the 'System Page' of an HDMI Matrix. The top navigation bar includes 'Admin', 'Log out', and 'Power on' buttons. The left sidebar lists menu items: Status, Video, Audio-HDMI, Audio-Extract, Input, Output, CEC, Network, and System (highlighted). The main content area is divided into several sections:

- Panel Lock:** A toggle switch currently set to 'OFF'.
- Beep:** A toggle switch currently set to 'ON'.
- LCD:** A selection bar with options: OFF, Always on, 15s, 30s (selected), and 60s.
- Serial Baud Rate:** A selection bar with options: 4800, 9600, 19200, 38400, 57600, and 115200 (selected).
- Firmware Update:** A section with a 'Browse' button, a file selection input, and an 'Update' button.
- Factory Reset:** A section with a 'Reset' button.
- Reboot:** A section with a 'Reboot' button.

- ① **Panel Lock:** Click “Panel Lock” to lock/unlock panel buttons. “On” indicates that panel buttons are unavailable; “Off” indicates panel buttons are available.
 - ② **Beep:** Click “Beep” to turn on/off the beep.
 - ③ **LCD:** You can turn on/off the LCD, and set the turn-on time (15s/30s/60s).
 - ④ **Serial Baud Rate:** Click the value to set the Serial Baud Rate.
 - ⑤ **Firmware Update:** Click “Browse” to select the update file, then click “Update” to complete firmware update.
 - ⑥ **Factory Reset:** You can reset the machine to factory defaults by clicking “Reset”.
 - ⑦ **Reboot:** You can reboot the machine by clicking “Reboot”.
- Note:** After reset/reboot, it will switch to the login page.

12. RS-232 Control Command

The product also supports RS-232 control. You need a serial cable with RS-232 male head and DB9 transfer USB male head. The RS-232 head of the serial cable is connected to the RS-232 control port with DB 9 at the rear of the Matrix, and the USB head of the serial cable is connected to a PC. The connection method is as follows:

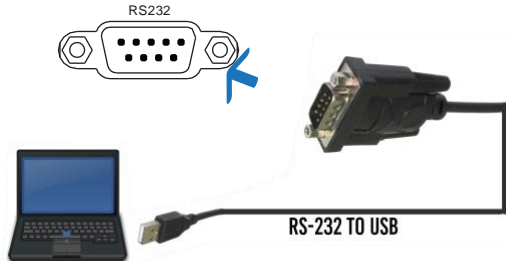

Then, open a Serial Command tool on PC to send ASCII command to control the Matrix.

The ASCII command list about the product is shown as below.

ASCII Command				
Serial port protocol. Baud rate: 115200, Data bits: 8bit, Stop bits:1, Check bit: 0				
x - Parameter 1 y - Parameter 2 ! - Delimiter				
ASCII Command	Function Description	Example	Feedback	Default Setting
Power				
s power z!	Power on/off the device,z=0~1 (z=0 power off, z=1 power on)	s power 1!	Power on System Initializing... Initialization Finished! power off POWER 0	power on
r power!	Get current power state	r power!	power on/power off	
s reboot!	Reboot the device	s reboot!	Reboot... System Initializing... Initialization Finished! FW version 1.00.01	
System Setup				
help!	List all commands	help!		
r type!	Get device model	r type!	HDM-B44H100P	
r status!	Get device current status	r status!	Get the unit all status: power, beep, lock, in/ out connection, video/ audio crosspoint, edid, scaler,hdcp, network status	

ASCII Command	Function Description	Example	Feedback	Default Setting
r fw version!	Get Firmware version	r fw version!	MCU BOOT: V1.00.02 MCU APP: V1.00.01 WEB GUI: V1.01	
r link in x!	Get the connection status of the x input port, x=0~4(0=all)	r link in 1!	hdmi input 1: connect	
r link out y!	Get the connection status of the y output port, y=0~40=all)	r link out 1!	hdmi output 1: connect hdmi output 1: connect	
s reset!	Reset to factory defaults	s reset!	Reset to factory defaults System Initializing... Initialization Finished! FW version 1.00.01	
s beep z!	Enable/Disable buzzer function, z=0~1(z=0 beep off, z=1 beep on)	s beep 1!	beep on beep off	beep on
r beep!	Get buzzer state	r beep!	beep on / beep off	
s lock z!	Lock/Unlock front panel button, z=0~1 (z=0 lock off,z=1 lock on)	s lock 1!	panel button lock on panel button lock off	panel button lock off
r lock!	Get panel button lock state	r lock!	panel button lock on/off	
s lcd on time z!	Set LCD screen remain on time, z=0~4 (0:always on, 2:15s, 3:30s, 4:60s)	s lcd on time 1!	lcd on always	lcd on 30 seconds
r lcd mode!	Get the backlight status of lcd screen	r lcd mode!	lcd on always	
s save preset z!	Save switch state between all output port and the input port to preset z. z=1~4	s save preset 1!	save to preset 1	
s recall preset z!	Call saved preset z scenarios, z=1~4	s recall preset 1!	recall from preset 1	
s clear preset z!	Clear stored preset z scenarios, z=1~4	s clear preset 1!	clear preset 1	
r preset z!	Get preset z information, z=1~4	r preset 1!	video/audio crosspoint	
s ptp!		s ptp!	ptp	ptp
Output Setting				
s in x av out y!	Set input x to output y, x=1~4, y=0~4(0=all)	s in 1 av out 2!	input 1 -> output 2	input 1 -> output 1 input 2 -> output 2 input 3 -> output 3 input 4 -> output 4
r av out y!	Get output y signal status y=0~4(0=all)	r av out 0!	input 1 -> output 1 input 2 -> output 2 input 3 -> output 3 input 4 -> output 4	
s hdmi y stream z!	Set hdmi output y stream on/off, y=0~4(0=all) z=0~1(0:disable,1:enable)	s hdmi 1 stream 1! s hdmi 0 stream 1!	Enable hdmi output 1 stream Disable hdmi output 1 stream Enable hdmi all outputs stream Disable hdmi all outputs stream	Enable hdmi all outputs stream
r hdmi y stream!	Get hdmi output y stream status, y=0~4(0=all)	r hdmi 1 stream!	Enable hdmi output 1 stream Disable hdmi output 1 stream	

ASCII Command	Function Description	Example	Feedback	Default Setting
s hdbt y stream z!	Set hdbt output y stream on/off, y=0~4(0=all) z=0~1(0:disable,1:enable)	s hdbt 1 stream 1! s hdbt 0 stream 1!	Enable hdbt output 1 stream Disable hdbt output 1 stream Enable hdbt all outputs stream Disable hdbt all outputs stream	Enable hdbt all outputs stream
r hdbt y stream!	Get hdbt output y stream status, y=0~4(0=all)	r hdbt 1 stream!	Enable hdbt output 1 stream Disable hdbt output 1 stream	
s hdmi y scaler z!	Set hdmi output y port output scaler mode, y=0~4(0=all), z=1~3(1=bypass,2=4k->1080p, 3=Auto)	s hdmi 1 scaler 1! s hdmi 0 scaler 1!	hdmi output 1 set to bypass mode hdmi all outputs set to bypass mode	hdmi all outputs set to bypass
r hdmi y scaler!	Get hdmi output y port output mode y=0~4(0=all)	r hdmi 1 scaler!	hdmi output 1 set to bypass mode	
s hdbt y scaler z!	Set hdbt output x port output scaler mode, y=0~4(0=all), z=1~3(1=bypass,2=4k->1080p, 3=Auto)	s hdbt 1 scaler 2! s hdbt 0 scaler 2!	hdbt output 1 set to 4k->1080p mode hdbt all outputs set to 4k->1080p mode	hdbt all outputs set to bypass
r hdbt y scaler !	Get hdbt output y port output scaler mode y=0~4(0=all)	r hdbt 1 scaler !	hdbt output 1 set to 4k->1080p mode	
EDID Setting				
s edid in x from z!	Set input x EDID from default EDID z, x=0~4(0=all),z=1~31 1=1080p,Stereo Audio 2.0 2=1080p,Dolby/DTS 5.1 3=1080p,HD Audio 7.1 4=1080i,Stereo Audio 2.0 5=1080i,Dolby/DTS 5.1 6=1080i,HD Audio 7.1 7=3D,Stereo Audio 2.0 8=3D,Dolby/DTS 5.1 9=3D,HD Audio 7.1 10=4K2K30_444,Stereo Audio 2.0 11=4K2K30_444,Dolby/DTS 5.1 12=4K2K30_444,HD Audio 7.1 13=4K2K60_420,Stereo Audio 2.0 14=4K2K60_420,Dolby/DTS 5.1 15=4K2K60_420,HD Audio 7.1 16=4K2K60_444,Stereo Audio 2.0 17=4K2K60_444,Dolby/DTS 5.1 18=4K2K60_444,HD Audio 7.1 19=4K2K60_444,Stereo Audio 2.0 HDR 20=4K2K60_444,Dolby/DTS 5.1 HDR 21=4K2K60_444,HD Audio 7.1 HDR 22=User1 23=User2 24~27=copy from hdmi output 1~4 28~31=copy from hdbt output 1~4	s edid in 1 from 1!	IN 1 EDID:1080p, Stereo Audio 2.0	IIN1: 1080p, Stereo Audio 2.0 IN2: 1080p, Stereo Audio 2.0 IN3: 1080p, Stereo Audio 2.0 IN4: 1080p, Stereo Audio 2.0
r edid in x!	Get EDID status of the input x, x=0~4(0=all input)	r edid in 0!	IN1 EDID: 4K2K60_444,Stereo Audio 2.0 IN2 EDID: 4K2K60_444,Stereo Audio 2.0 IN3 EDID: 4K2K60_444,Stereo Audio 2.0 IN4 EDID: 4K2K60_444,Stereo Audio 2.0	

ASCII Command	Function Description	Example	Feedback	Default Setting
r edid data hdmi y!	Get the EDID data of the hdmi output y port, y=1~4	r edid data hdmi 1!	EDID: 00 FF FF FF FF FF FF 00	
r edid data hdbt y!	Get the EDID data of the hdbt output y port, y=1~4	r edid data hdbt 1!	EDID: 00 FF FF FF FF FF FF 00	
r internal edid!	Get all built-in EDID information for unit support	r internal edid!	1,1080p,Stereo Audio 2.0 2,1080p,Dolby/DTS 5.1 3,1080p,HD Audio 7.1 4,1080i,Stereo Audio 2.0 20,4K2K60,Dolby/DTS 5.1 HDR 21,4K2K60,HD Audio 7.1 HDR	
Audio Setting				
s hdmi y arc z!	Turn on/off ARC of HDMI output y, y=0~4(0=all) z=0~1(z=0,off,z=1 on)	s hdmi 1 arc 1! s hdmi 0 arc 1!	hdmi output 1 arc on hdmi output 1 arc off hdmi all outputs arc on hdmi all outputs arc off	hdmi all outputs arc off
r hdmi y arc!	Get the ARC state of HDMI output y, y=0~4(0=all)	r hdmi 1 arc!	hdmi output 1 arc on	
s hdbt y arc z!	Turn on/off ARC of HDBT output y, y=0~4(0=all) z=0~1(z=0,off,z=1 on)	s hdbt 1 arc 1! s hdbt 0 arc 1!	hdbt output 1 arc on hdbt output 1 arc off hdbt all outputs arc on hdbt all outputs arc off	hdbt all outputs arc off
r hdbt y arc!	Get the ARC state of HDMI output y, y=0~4(0=all)	r hdbt 1 arc!	hdbt output 1 arc on	
s out y audio from z!	Set HDMI/HDBT output audio y=0~4(0=all),z=0~16 z=0, Default z=1~4 from HDMI input 1~4 z=5~8 from HDMI out 1~4 ARC z=9~12 from HDBT out 1~4 ARC z=13~16 from embed audio 1~4 Attention: when z=0,HDMI/HDBT audio can't set audio delay.	s out 1 audio from 1! s out 0 audio from 1!	HDMI/HDBT output 1 audio: from HDMI input 1 HDMI/HDBT all outputs audio: from HDMI input 1	HDMI/HDBT all outputs from default
r out y audio!	Get HDMI/HDBT output audio status y=0~4(0=all)	r out 1 audio!	HDMI/HDBT output 1 from HDMI input 1	
s coax_analog out y audio from z!	Set coaxial output audio y=0~4(0=all),z=1~1 z=1~4 from HDMI input 1~4 z=5~8 from HDMI out 1~4 ARC z=9~12 from HDBT out 1~4 ARC z=13~16 from embed audio 1~4	s coax_analog out 1 audio from 1! s coax_analog out 0 audio from 1!	Coaxial_Analog output 1 audio: from HDMI input 1 Coaxial_Analog all outputs audio: from HDMI input 1	Coaxial_Analog all outputs audio: from HDMI input 1
s coax_analog out y audio delay z!	Set coax_analog output audio delay y=0~4(0=all), z=0~300ms	s coax_analog out 1 audio delay 100! s coax_analog out 0 audio delay 100!	Coaxial_Analog output 1 audio delay 100ms Coaxial_Analog all outputs audio delay 100ms	Coaxial_Analog all outputs audio delay 100ms
s coax_analog out y audio mute z!	Mute on/off coax_analog output audio y=0~4(0=all), z=0~1(z=0 off,z=1 on)	s coax_analog out 1 audio mute 1!	Mute coax_analog output 1 audio	Mute off all coax_analog out audio

ASCII Command	Function Description	Example	Feedback	Default Setting
s coax_analog out y audio vol z!	Set analog output audio volume y=0~4(0=all), z=0~30,+,-;	s analog out 1 audio vol 30! s analog out 1 audio vol +! s analog out 0 audio vol 30! s analog out 0 audio vol +!	Analog output 1 audio volume 30 Analog all outputs audio volume 30	all Analog output audio volume 20
r coax_analog out y audio!	Get coax_analog output audio status y=0~4(0=all)	r coax_analog out 1 audio!	Coaxial_Analog output 1 audio from HDMI input 1 Coaxial_Analog output 1 audio delay 0ms Analog output 1 audio volume 20 Mute off coax_analog output 1 audio	
CEC Setting				
s cec in x on!	set input x power on by CEC, x=0~4(0=all input)	s cec in 1 on!	input 1 power on	
s cec in x off!	set input x power off by CEC, x=0~4(0=all input)	s cec in 1 off!	input 1 power off	
s cec in x menu!	set input x open menu by CEC, x=0~4(0=all input)	s cec in 1 menu!	input 1 open menu	
s cec in x back!	set input x back operation by CEC, x=0~4(0=all input)	s cec in 1 back!	input 1 back operation	
s cec in x up!	set input x menu up operation by CEC, x=0~4(0=all input)	s cec in 1 up!	input 1 menu up operation	
s cec in x down!	set input x menu down operation by CEC, x=0~4(0=all input)	s cec in 1 down!	input 1 menu down operation	
s cec in x left!	set input x menu left operation by CEC, x=0~4(0=all input)	s cec in 1 left!	input 1 menu left operation	
s cec in x right!	set input x menu right operation by CEC, x=0~4(0=all input)	s cec in 1 right!	input 1 menu right operation	
s cec in x enter!	set input x menu enter by CEC, x=0~4(0=all input)	s cec in 1 enter!	input 1 menu enter operation	
s cec in x play!	set input x play by CEC, x=0~4(0=all input)	s cec in 1 play!	input 1 play operation	
s cec in x pause!	set input x pause by CEC, x=0~4(0=all input)	s cec in 1 pause!	input 1 pause operation	
s cec in x stop!	set input x stop by CEC, x=0~4(0=all input)	s cec in 1 stop!	input 1 stop operation	
s cec in x rew!	set input x rewind by CEC, x=0~4(0=all input)	s cec in 1 rew!	input 1 rewind operation	
s cec in x mute!	set input x volume mute by CEC, x=0~4(0=all input)	s cec in 1 mute!	input 1 volume mute	
s cec in x vol-!	set input x volume down by CEC, x=0~4(0=all input)	s cec in 1 vol-!	input 1 volume down	
s cec in x vol+!	set input x volume up by CEC, x=0~4(0=all input)	s cec in 1 vol+!	input 1 volume up	
s cec in x ff!	set input x fast forward by CEC, x=0~4(0=all input)	s cec in 1 ff!	input 1 fast forward operation	
s cec in x previous!	set input x previous by CEC, x=0~4(0=all input)	s cec in 1 previous!	input 1 previous operation	

ASCII Command	Function Description	Example	Feedback	Default Setting
s cec in x next!	set input x next by CEC, x=0~4(0=all input)	s cec in 1 next!	input 1 next operation	
s cec hdmi out y on!	set hdmi output y power on by CEC, y=0~4(0=all hdmi output)	s cec hdmi out 1 on!	hdmi output 1 power on	
s cec hdbt out y on!	set hdbt output y power on by CEC, y=0~4(0=all hdbt output)	s cec hdbt out 1 on!	hdbt output 1 power on	
s cec hdmi out y off!	set hdmi output y power off by CEC, y=0~4(0=all hdmi output)	s cec hdmi out 1 off!	hdmi output 1 power off	
s cec hdbt out y off!	set hdbt output y power off by CEC, y=0~4(0=all hdbt output)	s cec hdbt out 1 off!	hdbt output 1 power off	
s cec hdmi out y mute!	set hdmi output y volume mute by CEC, y=0~4(0=all hdmi output)	s cec hdmi out 1 mute!	hdmi output 1 volume mute	
s cec hdbt out y mute!	set hdbt output y volume mute by CEC, y=0~4(0=all hdbt output)	s cec hdbt out 1 mute!	hdbt output 1 volume mute	
s cec hdmi out y vol-!	set hdmi output y volume down by CEC, y=0~4(0=all hdmi output)	s cec hdmi out 1 vol-!	hdmi output 1 volume down	
s cec hdbt out y vol-!	set hdbt output y volume down by CEC, y=0~4(0=all hdbt output)	s cec hdbt out 1 vol-!	hdbt output 1 volume down	
s cec hdmi out y vol+!	set hdmi output y volume up by CEC, y=0~4(0=all hdmi output)	s cec hdmi out 1 vol+!	hdmi output 1 volume up	
s cec hdbt out y vol+!	set hdbt output y volume up by CEC, y=0~4(0=all hdbt output)	s cec hdbt out 1 vol+!	hdbt output 1 volume up	
s cec hdmi out y active!	set hdmi output y active source by CEC, y=0~4(0=all hdmi output)	s cec hdmi out 1 active!	hdmi output 1 active source	
s cec hdbt out y active!	set hdbt output y active source by CEC, y=0~4(0=all hdbt output)	s cec hdbt out 1 active!	hdbt output 1 active source	
Network Setting				
r ipconfig!	Get the Current IP Configuration	r ipconfig!	IP Mode: DHCP IP:192.168.62.106 Subnet Mask: 255.255.255.0 Gateway:192.168.62.1 TCP/IP port:8000 Telnet port:23 Mac address: 6C:DF:FB:0C:B3:8E	
r mac addr!	Get network MAC address	r mac addr!	Mac address: 6C:DF:FB:0C:B3:8E	
s ip mode z!	Set network IP mode to static IP or DHCP, z=0~1 (z=0 Static, z=1 DHCP)	s ip mode 0!	Set IP mode:Static (Please use "s net reboot!" command or repower device to apply new config!)	DHCP ON
r ip mode!	Get network IP mode	r ip mode!	IP Mode: DHCP	
s ip addr xxx.xxx.xxx.xxx!	Set network IP address	s ip addr 192.168.1.100!	Set IP address: 192.168.1.100 (Please use "s net reboot!" command or repower device to apply new config!) DHCP on, Device can't config static address, set DHCP off first.	
r ip addr!	Get network IP address	r ip addr!	IP:192.168.62.106	

ASCII Command	Function Description	Example	Feedback	Default Setting
s subnet xxx.xxx.xxx.xxx!	Set network subnet mask	s subnet 255.255.255.0!	Set subnet Mask address:255.255.255.0 (Please use "s net reboot!" command or reperower device to apply new config!) DHCP on, Device can't config subnet mask, set DHCP off first.	
r subnet!	Get network subnet mask	r subnet!	Subnet Mask: 255.255.255.0	
s gateway xxx.xxx.xxx.xxx!	Set network gateway	s gateway 192.168.1.1!	Set gateway: 192.168.1.1 Please use "s net reboot!" command or reperower device to apply new config! DHCP on, Device can't config gateway, set DHCP off first.	
r gateway!	Get network gateway	r gateway!	Gateway:192.168.1.1	
s tcp/ip port x!	Set network TCP/IP port (x=1~65535)	s tcp/ip port 8000!	Set TCP/IP port:8000	Set tcp/ip port:8000
r tcp/ip port!	Get network TCP/IP port	r tcp/ip port!	TCP/IP port:8000	
s telnet port x!	Set network telnet port (x=1~65535)	s telnet port 23!	Set Telnet port:23	Set telnet port:23
r telnet port!	Get network telnet port	r telnet port!	Telnet port:23	
s net reboot!	Reboot network modules	s net reboot!	Search for IP,Please wait ...! IP Mode: DHCP IP:192.168.62.111 Subnet Mask: 255.255.255.0 Gateway:192.168.62.1 TCP/IP port:8000 Telnet port:23 Mac address: 6C:DF:FB:0C:B3:8E	
s uart x mode y!	Set the mode of x local and hdbt uart , x=0-4 ,y=0-1, 0:bypass mode, 1:user control mode	s uart 1 mode 1!	Local And Far Uart1 Control Mode	
s uart x datalen y!	Set the data length of x local and hdbt uart , x=0-8, y=1-2, 1:8bit 2:7bit	s uart 1 datalen 1!	LocalUart1 DataLen is 8bit	
s uart x baudrate y!	Set the baudrate of x local and hdbt uart , x=0-8(0=all,1~4=local uart,5~8=hdbt uart), y=1-8, 1: 115200(Default) 2: 57600 3: 56000 4:38400 5:19200 6:14400 7:9600 8:4800	s uart 1 baudrate 1!	LocalUart%d Baudrate is 115200	
s uart x parity y!	Set the Parity of x local and hdbt uart, x=0-8, y=1-3, 1:none 2:odd 3:even	s uart x parity 1!	LocalUart1 Parity is None	
s uart x type z senddata y end!	Send data y from x local and hdbt uart, z=0 ascii, z=1 hex ,x=0-4	s uart 1 type 0 senddata abcdefg end!	LocalUart1 data: abcdefg	
r uart status x!	Get the Status of x local and hdbt uart , x=0-4	r uart status 1!		

13. Application Example

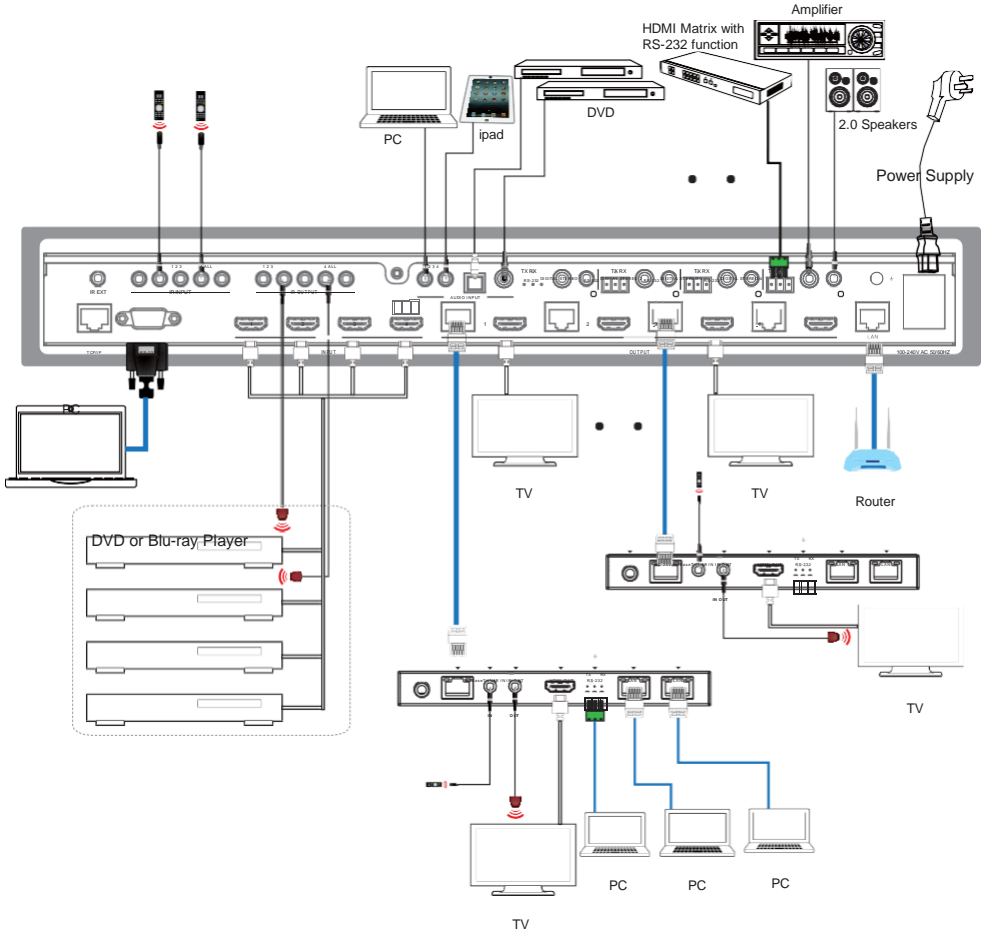

14. Warranty

BZBGear wants to assure you peace of mind. We're so confident in the quality of our products that along with the manufacturer's one-year limited warranty, we are offering free second-year warranty coverage upon registration*.

Taking advantage of this program is simple, just follow the steps below:

1. Register your product within 90 days of purchase by visiting [BZBGear.com/warranty](https://www.bzbgear.com/warranty).
2. Complete the registration form. Provide all necessary proof of purchase details, including serial number and a copy of your sales receipt.

For questions, please call 1.888.499.9906 or email support@bzbgear.com.

For complete warranty information, please visit [BZBGear.com/warranty](https://www.bzbgear.com/warranty) or scan the QR code below.



*Terms and conditions apply. Registration is required.

15. Mission Statement

BZBGear manifests from the competitive nature of the audiovisual industry to innovate while keeping the customer in mind. AV solutions can cost a pretty penny, and new technology only adds to it. We believe everyone deserves to see, hear, and feel the advancements made in today's AV world without having to break the bank. BZBGear is the solution for small to medium-sized applications requiring the latest professional products in AV.

We live in a DIY era where resources are abundant on the internet. With that in mind, our team offers system design consultation and expert tech support seven days a week for the products in our BZBGear catalog. You'll notice comparably lower prices with BZBGear solutions, but the quality of the products is on par with the top brands in the industry. The unparalleled support from our team is our way of showing we care for every one of our customers. Whether you're an integrator, home theater enthusiast, or a do-it-yourselfer, BZBGear offers the solutions to allow you to focus on your project and not your budget.