

1A Step-Up Current Regulator for Flash LEDs**General Description**

The AAT1270 is a high-efficiency, high-current boost converter capable of 1A maximum output current. It is an ideal power solution for LED photo flash applications in all single-cell Lithium-ion / polymer battery operated products.

The AAT1270 maintains output current regulation by switching the internal high-side and low-side switch transistors. The transistor switches are pulse-width modulated at a fixed frequency of 2MHz. The high switching frequency allows the use of a small inductor and output capacitor, making the AAT1270 ideally suited for small battery-powered applications.

Skyworks' proprietary S²Cwire™ (Simple Serial Control) serial digital interface is used to enable, disable and set the movie mode current level for the flash LEDs to one of 16 levels. The AAT1270 also includes a separate Flash Enable input to initiate both flash/strobe operation and the default timer, which can be used to terminate a flash event after a user-programmed delay or as a safety feature. A Flash Inhibit pin is also included which reduces flash current to movie mode level during high battery demand.

The maximum flash and movie mode current is set by one external resistor; the ratio between flash and movie mode current is set at approximately 7.3:1. One or two LEDs can be connected to the AAT1270; when two LEDs are used, the output current is matched between each diode.

The AAT1270 contains over-voltage protection and a thermal management system to protect the device in the event of an output open-circuit and short-circuit condition respectively. Built-in circuitry prevents excessive inrush current during start-up. The shutdown feature reduces quiescent current to less than 1.0µA.

The AAT1270 is available in a Pb-free, thermally-enhanced 14-pin 3x3mm STDFN package.

Features

- Input Voltage Range: 2.7V to 5.5V
- Dual Channel Output
 - Up to 1A Regulated Output Current (0.5A per Channel)
- Up to 85% Efficiency with Small Magnetics
- 2 MHz Switching Frequency
- Separate Flash Enable Input
- Separate Flash Inhibit Input
- Single Resistor Sets Flash and Movie Mode Current
 - Fixed Flash-to-Movie Mode Current Ratio
- 16-Level Movie Mode Current via S²Cwire™
- User-Programmable Safety Timer
- True Load Disconnect
- Input Current Limit
- Over-Voltage (Open LED, Open Circuit), Short-Circuit, and Over-Temperature Protection
- Shutdown Current: < 1.0µA
- Small Inductor Solution: 1µH (0.9mm in height)
- 14-pin STDFN 3x3 Package
- -40 to +85°C Temperature Range

Applications

- Camcorder Video Light (Torch Light)
- Cellphones / Smartphones
- Digital Still Cameras (DSC)
- LED Photo Flash Light (Strobe Light)
- Mobile Handsets
- MP3 Players
- PDAs and Notebook PCs

AAT1270

1A Step-Up Current Regulator for Flash LEDs

Typical Application

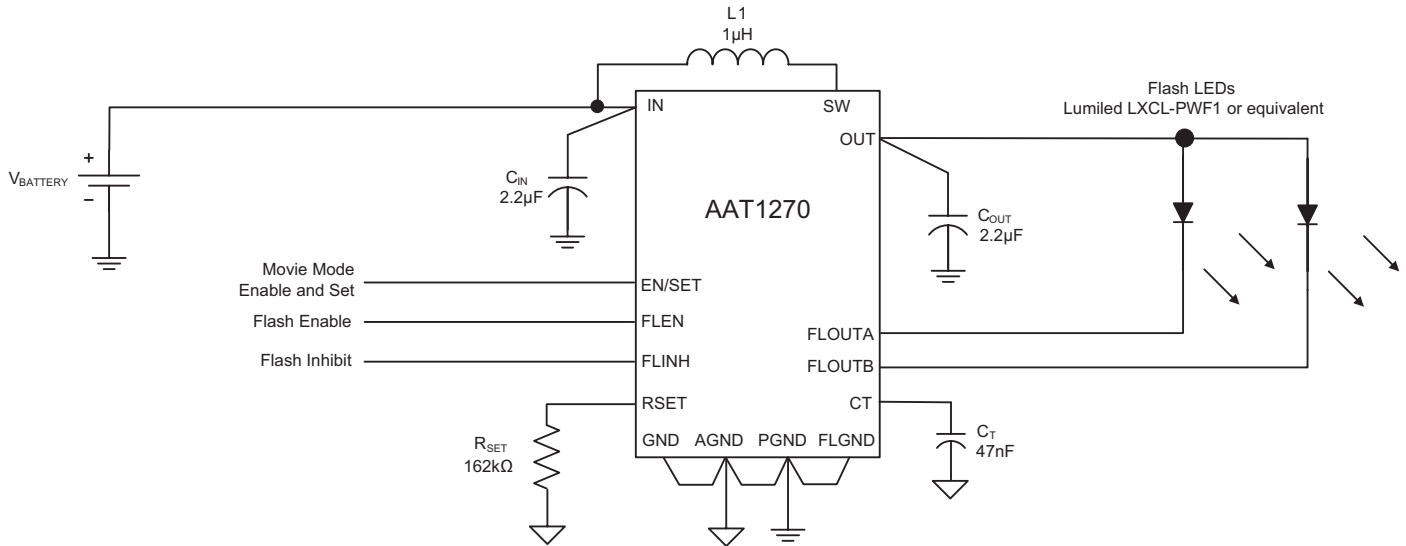

AAT1270**1A Step-Up Current Regulator for Flash LEDs****Pin Descriptions**

Pin #	Symbol	Function
1	CT	Flash timer control input. Connect a capacitor between CT and AGND to set maximum duration for the flash pulse. A 47nF ceramic capacitor sets the flash timer to 1s. To disable the flash timer, connect CT to AGND.
2	EN/SET	Enable and movie mode serial control input. EN/SET is the S ² Cwire programming input to adjust the movie mode current level to one of 16 different levels based on the maximum current/7.3 set via the RSET pin.
3	FLEN	Flash enable pin. A low-to-high transition on the FLEN pin initiates a flash pulse and starts the flash timer.
4	AGND	Analog ground pin. Connect AGND to PGND, GND, and FLGND at a single point as close to the AAT1270 as possible.
5	IN	Power input. Connect IN to the input power supply voltage. Connect a 2.2μF or larger ceramic capacitor from IN to PGND as close as possible to the AAT1270
6	SW	Boost converter switching node. Connect a 1μH inductor between SW and IN.
7	PGND	Power ground pin. Connect PGND to AGND, GND, and FLGND at a single point as close to the AAT1270 as possible.
8	OUT	Power output of the boost converter. Connect a 2.2μF or larger ceramic capacitor from OUT to PGND as close as possible to the AAT1270. Connect OUT to the anode(s) of the flash LED(s).
9	GND	Ground pin. Connect GND to PGND, AGND, and FLGND at a single point as close to the AAT1270 as possible.
10	FLINH	Flash inhibit pin. FLINH is an active HIGH control input with an internal 200kΩ resistor to AGND. A low-to-high transition on the FLINH pin reduces FLOUTA and FLOUTB output currents to the maximum (default) movie-mode current level for the duration of FLINH. Strobing the FLINH pin low to high does not reset the flash timer.
11	FLOUTB	Flash output B. Connect cathode of Flash LEDB to FLOUT B. For a single flash LED, connect FLOUTB and FLOUTA together. For two flash LEDs, each output will conduct 50% of the total flash output current.
12	FLGND	Flash ground pin. Connect FLGND to PGND, GND, and AGND at a single point as close to the AAT1270 as possible
13	FLOUTA	Flash output A. Connect cathode of Flash LED A to FLOUTA. For a single flash LED, connect FLOUTA and FLOUTB together. For two flash LEDs, each output will conduct 50% of the total flash output current.
14	RSET	Flash current setting input. A 162kΩ resistor from RSET to AGND sets the maximum flash current available at FLOUTA or FLOUTB to 500mA. Each FLOUTA and FLOUTB channel will conduct 50% of the maximum programmed current. The AAT1270's flash-to-movie-mode ratio is fixed at 7.3.
EP		Exposed paddle (bottom); Connect EP to PGND as close as possible to the AAT1270.

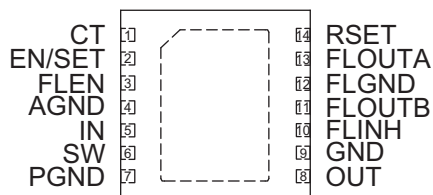
Pin Configuration**STDFN33-14
(Top View)**

1A Step-Up Current Regulator for Flash LEDs**Absolute Maximum Ratings¹**

$T_A = 25^\circ\text{C}$ unless otherwise noted.

Symbol	Description	Value	Units
IN, SW, OUT	Maximum Rating	-0.3 to 6.0	V
RSET, EN/SET, FLEN, FLINH, CT, FLOUTA, FLOUTB	Maximum Rating	$V_{IN} + 0.3$	V
T_J	Operating Temperature Range	-40 to 150	$^\circ\text{C}$
T_S	Storage Temperature Range	-65 to 150	$^\circ\text{C}$
T_{LEAD}	Maximum Soldering Temperature (at leads, 10 sec)	300	$^\circ\text{C}$

Recommended Operating Conditions

Symbol	Description	Value	Units
θ_{JA}	Thermal Resistance	50	$^\circ\text{C}/\text{W}$
P_D	Maximum Power Dissipation	2	W

1. Stresses above those listed in Absolute Maximum Ratings may cause permanent damage to the device. Functional operation at conditions other than the operating conditions specified is not implied. Only one Absolute Maximum Rating should be applied at any one time.

1A Step-Up Current Regulator for Flash LEDs

Electrical Characteristics¹

$V_{IN} = 3.6V$; $C_{IN} = 2.2\mu F$; $C_{OUT} = 2.2\mu F$; $L = 1\mu H$; $R_{SET} = 162k\Omega$; $T_A = -40^\circ C$ to $+85^\circ C$, unless otherwise noted. Typical values are $T_A = 25^\circ C$.

Symbol	Description	Conditions	Min	Typ	Max	Units
Power Supply						
V_{IN}	Input Voltage Range		2.7		5.5	V
$V_{OUT(MAX)}$	Maximum Output Voltage				5.5	V
$I_{IN(Q)}$	V_{IN} Supply Current	FLEN = IN, Set FL Load = 1A		0.57	1	mA
		EN/SET = IN, Set FL Load = 0A, $R_{SET} = 162k\Omega$		0.23		
$I_{SHDN(MAX)}$	V_{IN} Shutdown Current	EN/SET = FLEN = FLINH = GND			1	μA
$I_{FL(TOTAL)}$	Total Output Current, Flash Mode	$R_{SET} = 162k\Omega$; FLOUTA + FLOUTB	800	1000	1200	mA
$I_{FL(MATCH)}$	FLOUTA and FLOUTB Current Matching			10		%
$I_{MM(TOTAL)}$	Total Output Current, Movie Mode	$R_{SET} = 162k\Omega$; Movie Mode Current Set = 100%; FLOUTA + FLOUTB		137		mA
f_{OSC}	Switching Frequency	$T_A = 25^\circ C$	1.5	2.0	2.5	MHz
$t_{DEFAULT}$	Default ON time	$C_T = 47nF$		1		s
T_{SD}	Thermal Shutdown Threshold			140		$^\circ C$
$T_{SD(HYS)}$	Thermal Shutdown Hysteresis			15		$^\circ C$
EN/SET/ FLEN/ FLINH Logic Control						
$V_{EN/SET(L)}$, $V_{FLEN(L)}$	EN/SET, FLEN Input Low Threshold				0.4	V
$V_{EN/SET(H)}$, $V_{FLEN(H)}$	EN/SET, FLEN Input High Threshold		1.4			V
$I_{EN/SET}$	EN/SET Input Leakage Current	$V_{EN/SET} = V_{IN} = 5V$	-1		1	μA
I_{FLEN}	FLEN Input Leakage Current	$V_{FLEN} = V_{IN} = 5V$	-1		1	μA
$V_{T(FLINH)}$	FLINH Input Threshold Voltage			$\frac{1}{2} V_{IN}$		V
$R_{IN(FLINH)}$	FLINH Input Resistance to AGND			200		k Ω
$t_{EN/SET(LOW)}$	EN/SET Serial Interface Low Time		0.3		75	μs
$t_{EN/SET(HI_MIN)}$	Minimum EN/SET High Time			50		ns
$t_{EN/SET(HI_MAX)}$	Maximum EN/SET High Time				75	μs
$t_{EN/SET(OFF)}$	EN/SET Off Timeout				500	μs
$t_{EN/SET(LAT)}$	EN/SET Latch Timeout				500	μs
t_{FLEN_ON}	FLEN ON Delay Time	EN/SET = GND		100		μs
t_{FLEN_OFF}	FLEN OFF Delay Time	EN/SET = GND		20		μs
t_{FLINH_ON}	FLINH ON Delay Time			100		μs
t_{FLINH_OFF}	FLINH OFF Delay Time			5		μs

1. The AAT1270 is guaranteed to meet performance specifications over the $-40^\circ C$ to $+85^\circ C$ operating temperature range and is assured by design, characterization, and correlation with statistical process controls.

1A Step-Up Current Regulator for Flash LEDs

Typical Characteristics

Efficiency vs. Input Voltage
(Movie and Flash Mode)

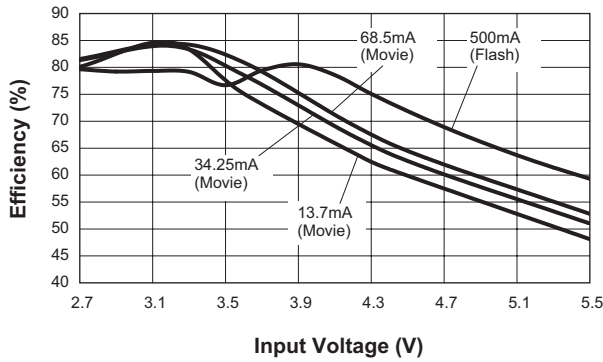

Shutdown Current vs. Input Voltage
(EN/SET = FLEN = 0V)

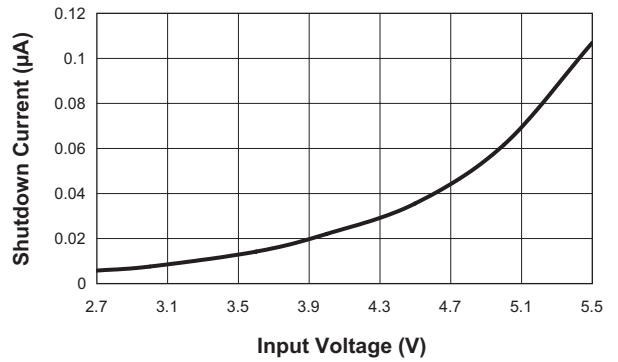

Switching Frequency vs. Input Voltage
(EN/SET = FLEN = 0V)

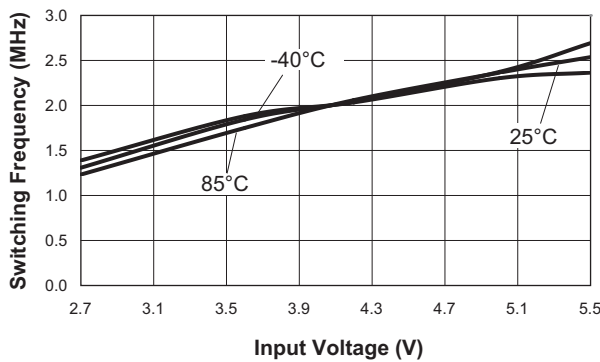

Movie Mode LED Current Accuracy vs. Input Voltage
(68.5mA/Ch)

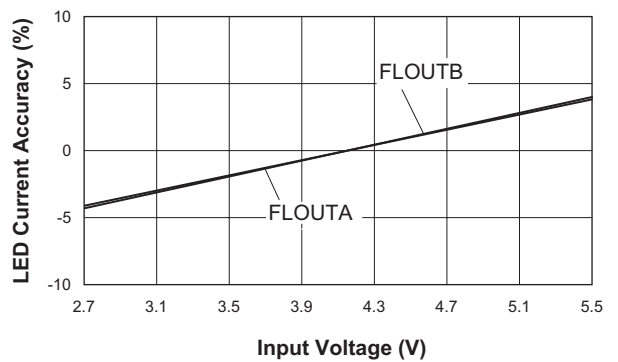

Movie Mode Current Matching vs. Temperature
(68.5mA/ch)

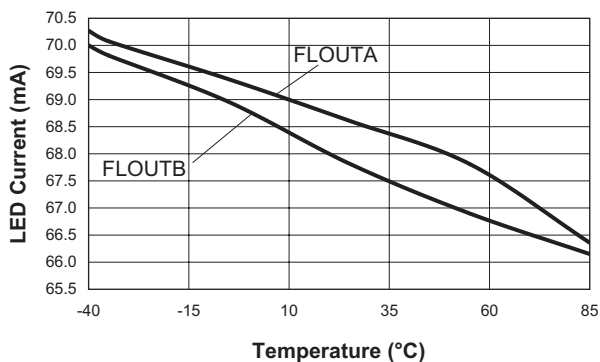

Flash Mode Current Matching vs. Temperature
(500mA/ch)

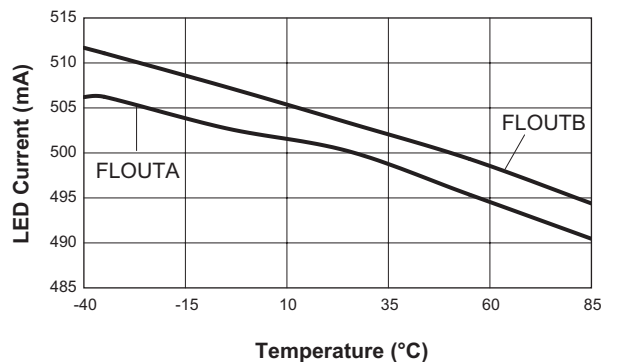

Typical Characteristics

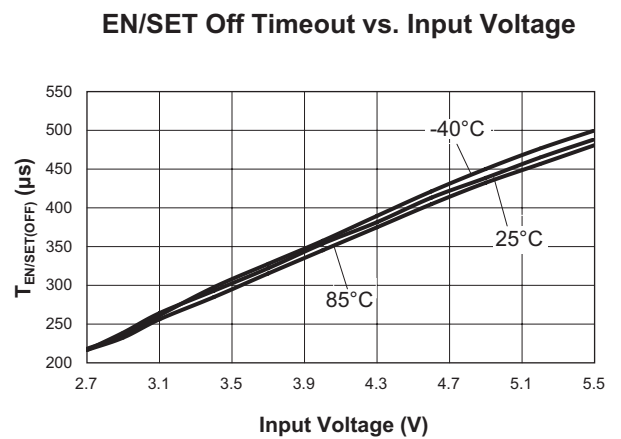
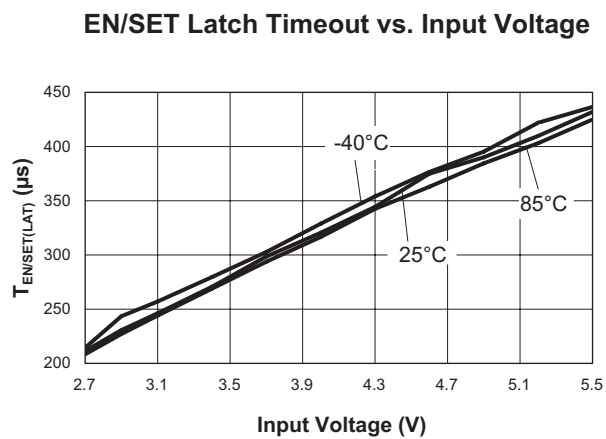
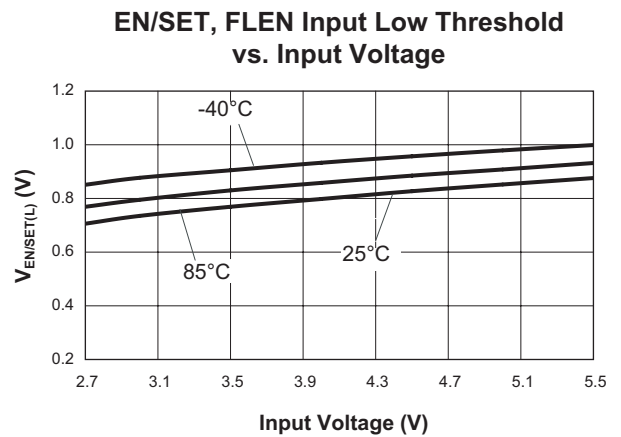
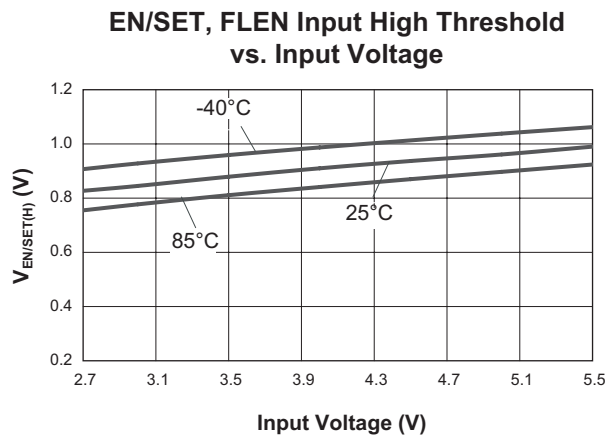
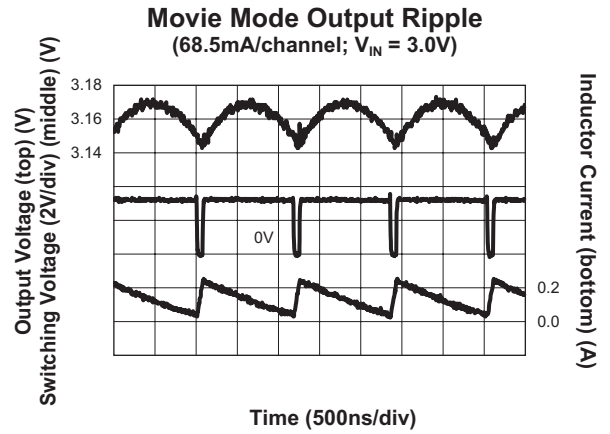
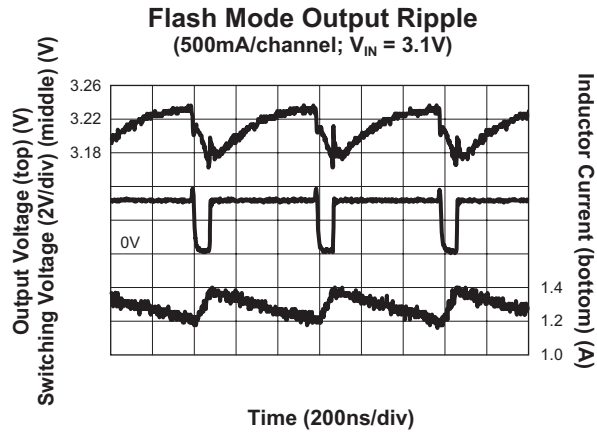

Typical Characteristics

FLEN ON Delay Time vs. Input Voltage

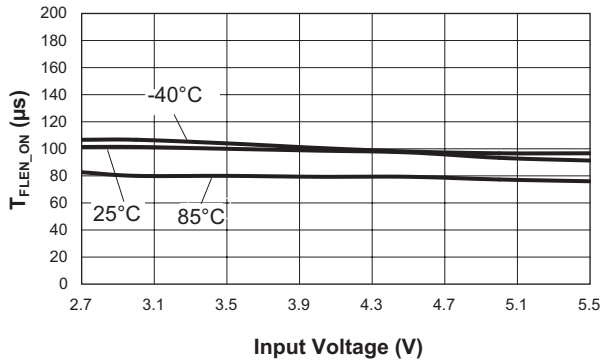

Flash Inhibit On Delay Time
(EN/SET = 0V; FLEN = 3.3V; 500mA/ch)

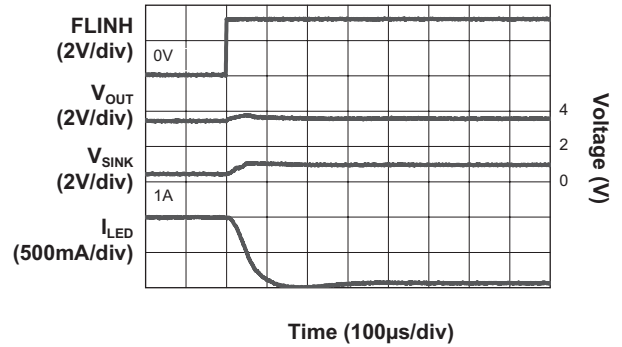

Movie Mode Turn On
(13.7mA/ch)

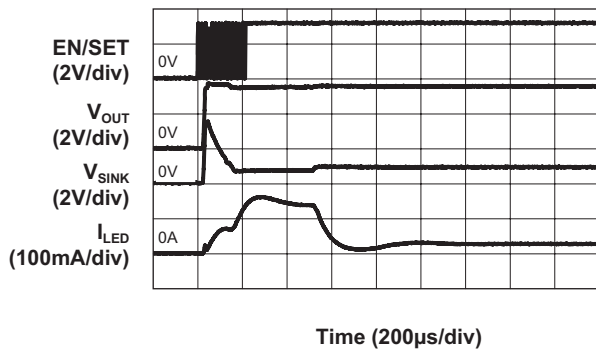

Movie Mode Turn On
(68.5mA/ch)

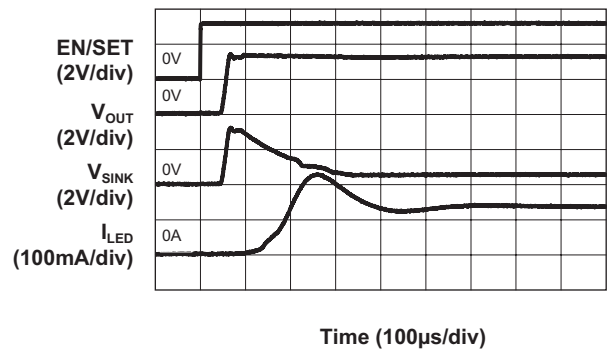

Movie Mode to Flash Mode Turn On
(68.5mA/ch to 500mA/ch)

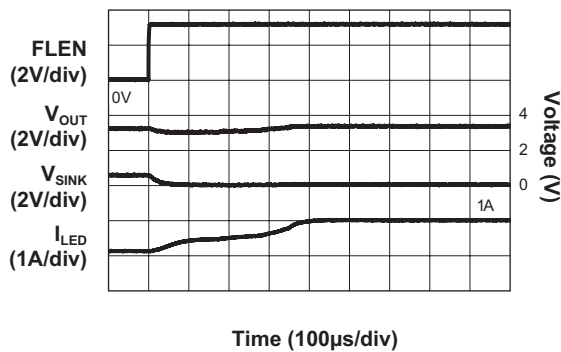

Flash Mode Turn On
(500mA/ch)

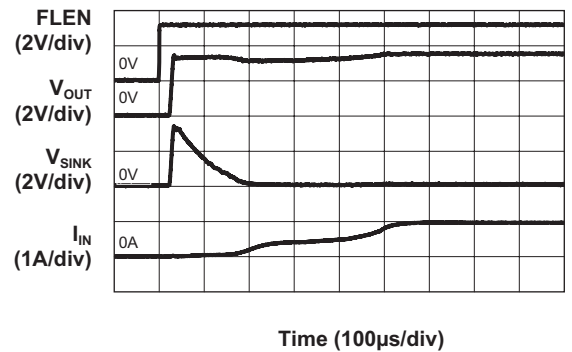

1A Step-Up Current Regulator for Flash LEDs

Typical Characteristics

Movie Mode Line Transient
(68.5mA/ch; $V_{IN} = 4.2V$ to $3.6V$)

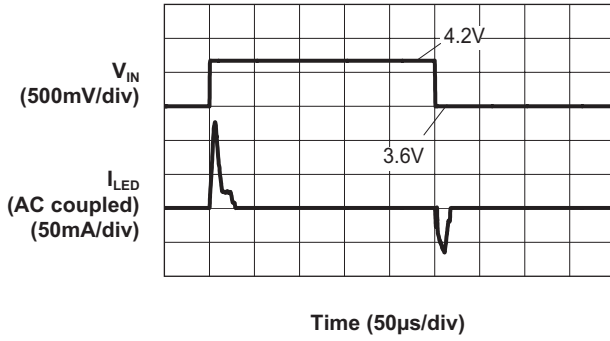

Movie Mode Current Transition
(68.5mA/ch to 13.7mA/ch)

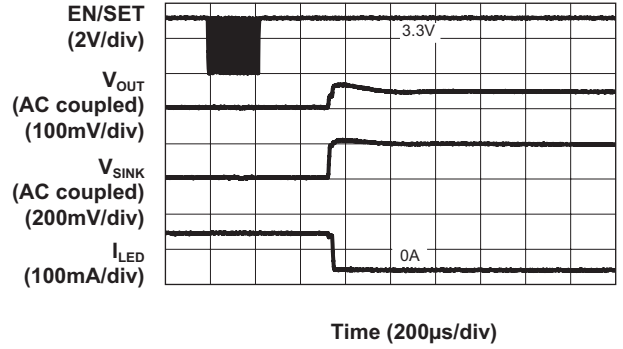

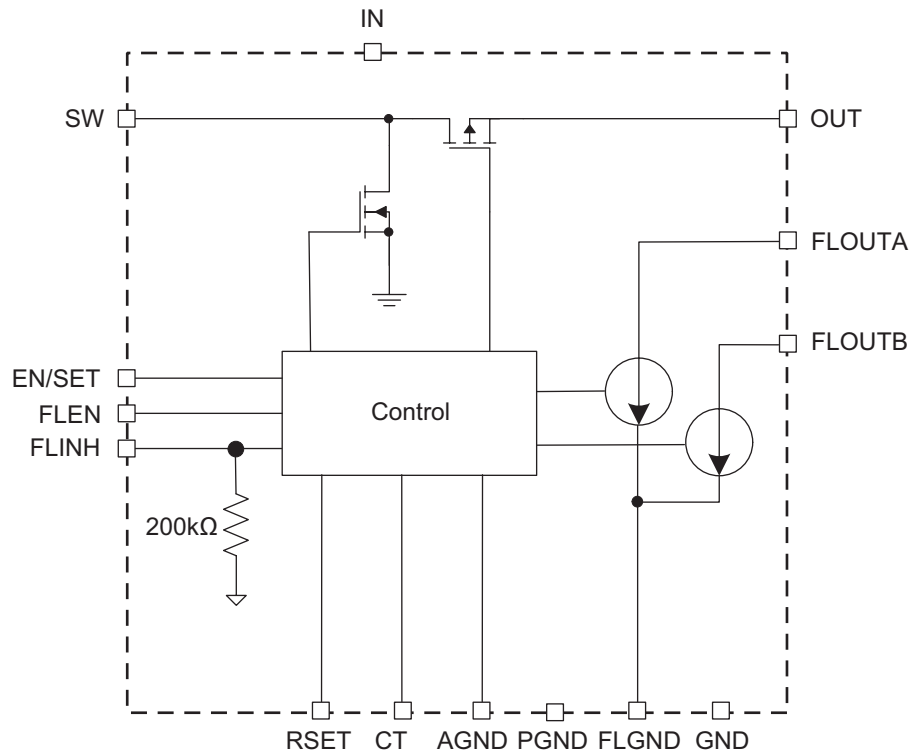
Functional Block Diagram**Functional Description**

The AAT1270 is a boost converter with a current regulated output designed to drive high current white LEDs used in flash/movie light applications. The maximum flash current is set by an external resistor, R_{SET} , which not only sets the flash current but also sets the maximum movie mode current reduced by a factor of 7.3. A flash pulse is initiated by switching the FLEN (flash enable) pin from low to high, which initiates the flash pulse and also starts the internal timer. The maximum flash time is determined by an external timing capacitor connected to the CT pin. The flash duration can be set from 50ms to a maximum of 1s. The flash timer will terminate the flash current regardless of the status of the FLEN pin.

This can be either used as a simple flash timing pulse or as a safety timer in the event of a control logic malfunction to prevent the LED from over-heating. If the safety timer is not needed in the application, it can be disabled by connecting the CT pin directly to AGND.

For applications using two flash LEDs, each diode can be connected to its corresponding current sink (FLOUTA or FLOUTB) and the output current will be equally shared. In single flash LED applications, the two current sinks can be connected together to apply the full output current into the LED.

If one sink pin (FLOUTA or FLOUTB) is not used, the unused current sink must be directly connected to OUT, which disables that channel.

1A Step-Up Current Regulator for Flash LEDs

The movie-mode output current is controlled by the EN/SET pin, which uses a single-wire S²Cwire interface to adjust the output current to one of 16 different levels. As shown in Table 1, the current settings are in logarithmic scale where each code is 1dB below the previous code. The FLEN signal takes priority over movie-mode operation.

In mobile GSM systems where the phone remains in constant contact with the base station by regular communication, a FLINH pin is provided to prevent the camera flash and PA transmission pulses from occurring simultaneously, potentially causing the battery voltage to drop below the system's undervoltage lockout threshold (UVLO) or creating unwanted EMI.

During a flash event, strobing the FLINH pin low-to-high will reduce the LED current to the maximum movie mode current level for the duration of FLINH. Strobing FLINH high-to-low will instruct the AAT1270 to revert the flash LED current to its default (maximum) level assuming that the FLEN pin is still active (HIGH) and that the flash timer has not expired.

Over-Temperature Protection

Thermal protection disables the AAT1270 when internal power dissipation becomes excessive, as it disables both MOSFETs. The junction over-temperature threshold is 140°C with 15°C of temperature hysteresis. The output voltage automatically recovers when the over-temperature fault condition is removed.

Over-Voltage Protection (Open LED, Open Circuit)

The AAT1270's output voltage is limited by internal over-voltage protection circuitry, which prevents damage to the AAT1270 from open LED or open circuit conditions.

During an open circuit, the output voltage rises and reaches 5.5V (typical), and the OVP circuit disables the switching, preventing the output voltage from rising higher. Once the open circuit condition is removed, switching will resume. The controller will return to normal operation and maintain an average output voltage.

Applications Information**LED Selection**

The AAT1270 is specifically designed to drive white flash LEDs (typical forward voltage of 2.5V to 4.5V). Since the FLOUTA and FLOUTB input current sinks are matched with low voltage dependence; the LED-to-LED brightness will be matched regardless of the individual LED forward voltage (V_F) levels.

Flash Mode LED Current

The LED current is controlled by the R_{SET} resistor. For maximum accuracy, a 1% tolerance resistor is recommended. FLOUTA and FLOUTB can be programmed up to a maximum total flash current of 1A, or up to 500mA per channel. FLOUTA and FLOUTB output current is matched across the programming range.

The maximum flash current in each FLOUTA and FLOUTB is set by the R_{SET} resistor and can be calculated using the following equation:

$$I_{FLOUTA} = I_{FLOUTB} = \frac{81k\Omega \cdot A}{R_{SET}} = \frac{81k\Omega \cdot A}{162k\Omega} = 500mA \text{ per channel}$$

Movie Mode LED Current

In the default movie mode, the corresponding FLOUTA/FLOUTB movie mode current can be calculated:

$$I_{MOVIE\ MODE[A/B]} = \frac{I_{FLOUTA/BIMAX}}{7.3}$$

For example, if an R_{SET} value of 162k Ω is chosen, then the FLOUTA/FLOUTB flash current is set to 500mA. For movie mode operation, the maximum current available at either FLOUTA or FLOUTB is then:

$$I_{MOVIE\ MODE[A/B]} = \frac{I_{FLOUTA/BIMAX}}{7.3} = \frac{500mA}{7.3} = 68.5mA$$

1A Step-Up Current Regulator for Flash LEDs

Alternatively, the AAT1270 S²Cwire interface programs the movie mode current at a reduced level. The FLOUTA/FLOUTB movie-mode current can be adjusted in logarithmic fashion to one of 16 steps. Table 1 illustrates approximate movie mode levels to which the AAT1270 movie mode operation can be programmed.

S ² Cwire Data	Percentage of Maximum Movie Mode Current (%)
1	100
2	89
3	79
4	71
5	63
6	56
7	50
8	44.7
9	39.8
10	35.5
11	31.6
12	28.2
13	25.1
14	22.4
15	20
16 ¹	0

Table 1: Programming Movie Mode Current via S²Cwire (%).

S²Cwire Serial Interface

The Simple Serial Control (S²Cwire) serial interface records rising edges at the EN/SET pin and decodes them into 16 different states. The S²Cwire serial interface has flexible timing. Data can be applied at speeds

faster than 1MHz, or at much slower speeds, such as 15kHz. After data is applied, EN/SET is strobed high and held high to latch the data.

Once the signal applied at the EN/SET pin has been held in the logic high state for time longer than t_{LAT} (500µs), the programmed current becomes active and the internal data register is reset to zero. For subsequent current level programming, the number of rising edges corresponding to the desired code must be applied to the EN/SET pin.

Flash Timer

The AAT1270A includes a timer circuit that enables the flash current sinks for a programmed period of time. This feature eliminates the need for an external, housekeeping baseband controller to contain a safety delay routine. It also serves as a protection feature to minimize thermal issues with the flash LEDs in the event an external controller’s flash software routine experiences hang-up or freeze.

The flash timeout T can be calculated by the following equation:

$$T = 21.5s/\mu F \cdot C_T$$

Where T is in seconds and C_T is the capacitance of the timer capacitor in µF.

For example, using a 47nF capacitor for C_T sets the flash timeout to:

$$\text{Flash Timeout} = 21.5s/\mu F \cdot 0.047\mu F = 1s$$

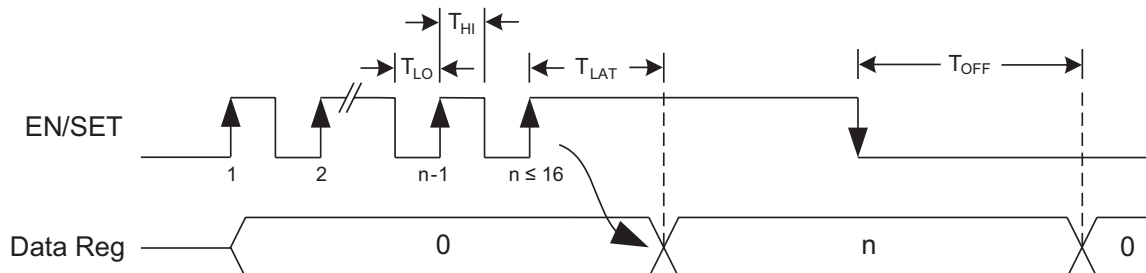

Figure 1: S²Cwire Serial Interface Timing.

1. When the device is in off state (EN/SET = 0V), programming S²Cwire data to DATA=16 for the first time will generate a small test current sourced through the two flash channels for a very short time. As a result, the two LEDs will blink.

1A Step-Up Current Regulator for Flash LEDs

The relationship between capacitance of the timer capacitor and the flash timeout is illustrated in Figure 2.

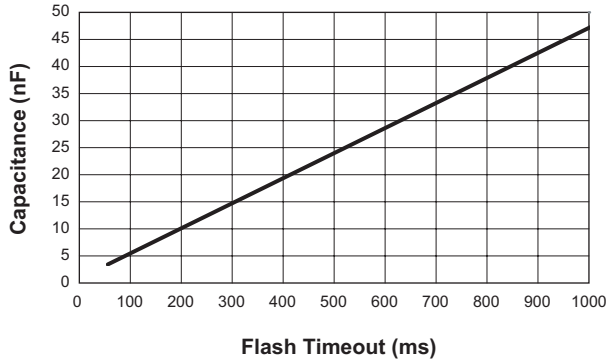

Figure 2: Timer Capacitor vs. Flash Timeout.

Selecting the Boost Inductor

The AAT1270 controller utilizes PWM control and the switching frequency is fixed. To maintain 2MHz maximum switching frequency and stable operation, an 1µH output inductor is recommended.

Manufacturer’s specifications list both the inductor DC current rating, which is a thermal limitation, and peak

inductor current rating, which is determined by the saturation characteristics. Measurements at full load and high ambient temperature should be performed to ensure that the inductor does not saturate or exhibit excessive temperature rise.

The output inductor (L) is selected to avoid saturation at minimum input voltage and maximum output load conditions. Worst-case peak current occurs at minimum input voltage (maximum duty cycle) and maximum load.

At high load the switching frequency is somewhat diminished, resulting in higher I_{PEAK} . Bench measurements are recommended to confirm actual I_{PEAK} and to ensure that the inductor does not saturate at maximum LED current and minimum input supply voltage.

The RMS current flowing through the boost inductor is equal to the DC plus AC ripple components. Under worst-case RMS conditions, the current waveform is critically continuous. The resulting RMS calculation yields worst-case inductor loss. The RMS current value should be compared against the inductor manufacturer’s temperature rise, or thermal derating, guidelines:

$$I_{RMS} = \frac{I_{PEAK}}{\sqrt{3}}$$

Timing Diagram

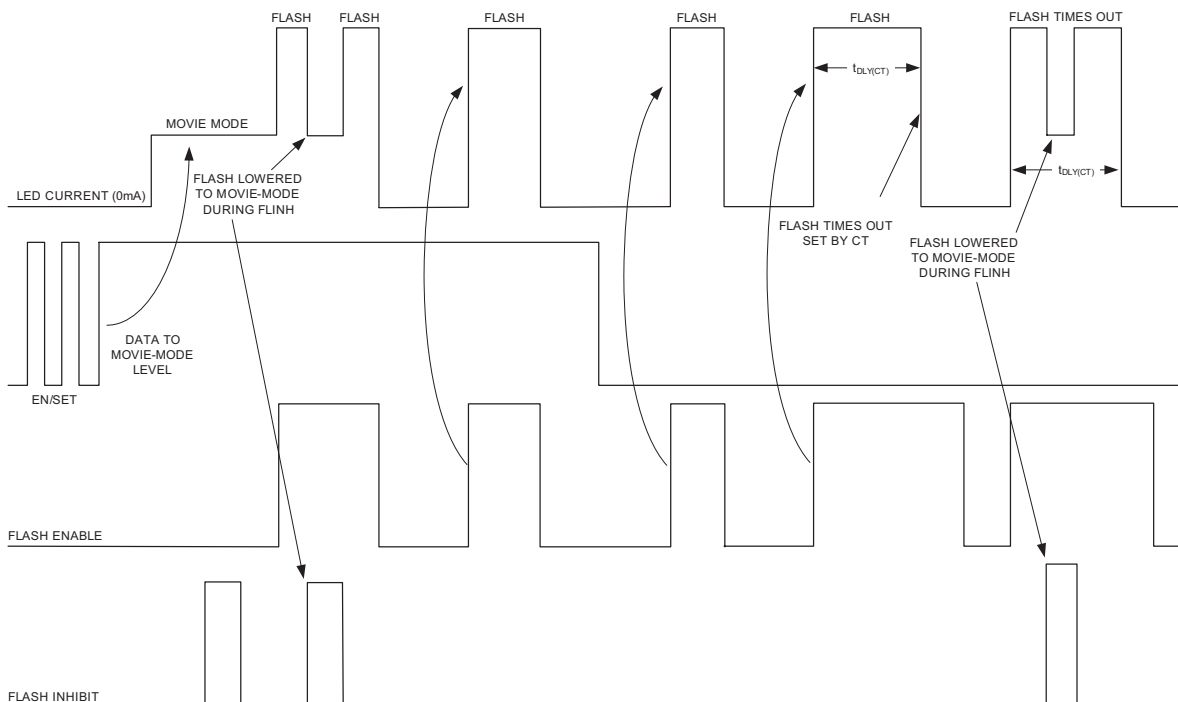

1A Step-Up Current Regulator for Flash LEDs

Manufacturer	Part Number	Inductance (μH)	Max DC I _{SAT} Current (A)	DCR (mΩ)	Size (mm) (LxWxH)	Type
Murata	LQM2HPN1R0MG0	1.0	1.6	55	2.5x2.0x0.9	Multilayer
Murata	LQH3NPN1R0G0	1.0	1.58	110	3.0x3.0x1.0	Wirewound
CoilCraft	LPS3010	1.0	1.6	85	3.0x3.0x1.0	Wirewound
Cooper Bussmann	SD3110	1.0	1.47	68.3	3.1x3.1x1.0	Wirewound
Cooper Bussmann	SD3812	1.0	2.69	48	4.0x4.0x1.2	Wirewound
Sumida	CDH38D11/S	1.0	2.8	39	4.0x4.0x1.2	Wirewound

Table 2: Typical Suggested Surface Mount Inductors.

For a given inductor type, smaller inductor size leads to an increase in DCR winding resistance and, in most cases, increased thermal impedance. Winding resistance degrades boost converter efficiency and increases the inductor's operating temperature:

$$P_{\text{LOSS(INDUCTOR)}} = I_{\text{RMS}}^2 \cdot \text{DCR}$$

Selecting the Boost Capacitors

In general, it is good design practice to place a decoupling capacitor (input capacitor) between the IN and GND pins. An input capacitor in the range of 2.2μF to 10μF is recommended. A larger input capacitor in this application may be required for stability, transient response, and/or ripple performance.

The high output ripple inherent in the boost converter necessitates the use of low impedance output filtering. Multi-layer ceramic (MLC) capacitors provide small size and adequate capacitance, low parasitic equivalent series resistance (ESR) and equivalent series inductance (ESL), and are well suited for use with the AAT1270

boost regulator. MLC capacitors of type X7R or X5R are recommended to ensure good capacitance stability over the full operating temperature range.

The output capacitor is selected to maintain the output load without significant voltage droop (ΔV_{OUT}) during the power switch ON interval. A ceramic output capacitor 2.2μF is recommended (see Table 3).

Typically, 6.3V or 10V rated capacitors are required for this flash LED boost output. Ceramic capacitors selected as small as 0603 are available which meet these requirements. MLC capacitors exhibit significant capacitance reduction with applied voltage. Output ripple measurements should confirm that output voltage droop and operating stability are within acceptable limits. Voltage derating can minimize this factor, but results may vary with package size and among specific manufacturers.

To maintain stable operation at full load, the output capacitor should be selected to maintain ΔV_{OUT} between 100mV and 200mV. The boost converter input current flows during both ON and OFF switching intervals. The input ripple current is less than the output ripple and, as a result, less input capacitance is required.

Manufacturer	Part Number	Capacitance (μF)	Voltage Rating (V)	Temp Co.	Case Size
Murata	GRM185R60J225KE26	2.2	6.3	X5R	0603
Murata	GRM188R71A225KE15	2.2	10	X7R	0603
Murata	GRM21BR70J225KA01	2.2	6.3	X7R	0805
Murata	GRM21BR71A225KA01	2.2	10	X7R	0805
Murata	GRM219R61A475KE19	4.7	10	X5R	0805
Murata	GRM21BR71A106KE51	10	10	X7R	0805

Table 3: Typical Suggested Surface Mount Capacitors.

1A Step-Up Current Regulator for Flash LEDs

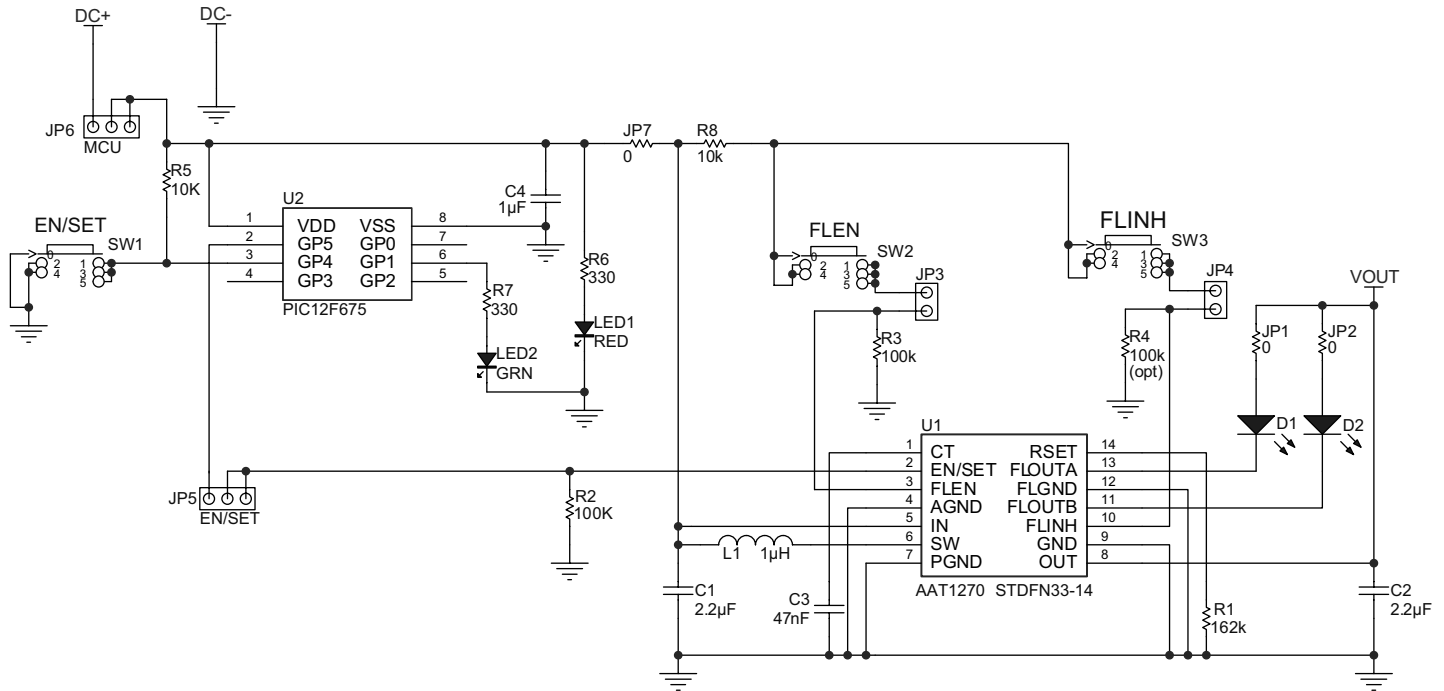

L1 Murata LQM2HPN1R0MG0 1µH 1.6A 55mΩ
 C1, C2 Murata GRM188R71A225KE15 2.2µF 0603 X7R 10V
 C3 Murata GRM155R71A473KA01 47nH 0402 X7R 10V

Figure 3: AAT1270 Evaluation Board Schematic.

PCB Layout Guidelines

Boost converter performance can be adversely affected by poor layout. Possible impact includes high input and output voltage ripple, poor EMI performance, and reduced operating efficiency. Every attempt should be made to optimize the layout in order to minimize parasitic PCB effects (stray resistance, capacitance, and inductance) and EMI coupling from the high frequency SW node. A suggested PCB layout for the AAT1270 1A step-up regulator is shown in Figures 4 through 7. The following PCB layout guidelines should be considered:

1. Minimize the distance from capacitor C_{IN} and C_{OUT} 's negative terminals to the PGND pins. This is especially true with output capacitor C_{OUT} , which conducts high ripple current from the output to the PGND pins.
2. Minimize the distance between L1 to IN and switching pin SW; minimize the size of the PCB area connected to the SW pin.
3. Maintain a ground plane and connect to the IC PGND pin(s) as well as the PGND connections of C_{IN} and C_{OUT} .
4. Consider additional PCB exposed area for the flash LEDs to maximize heatsinking capability. This may be necessary when using high current application and long flash duration application.
5. Connect the exposed paddle (bottom of the die) to either PGND or GND. Connect AGND, FLGND to GND as close as possible to the package.

AAT1270

1A Step-Up Current Regulator for Flash LEDs

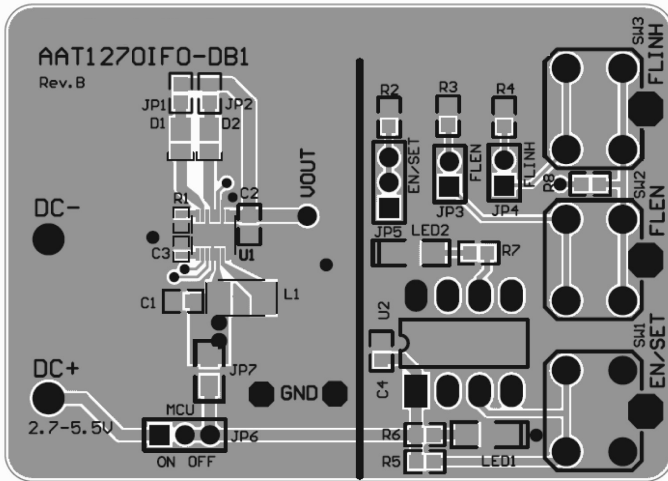

Figure 4: AAT1270 Evaluation Board Top Side Layout.

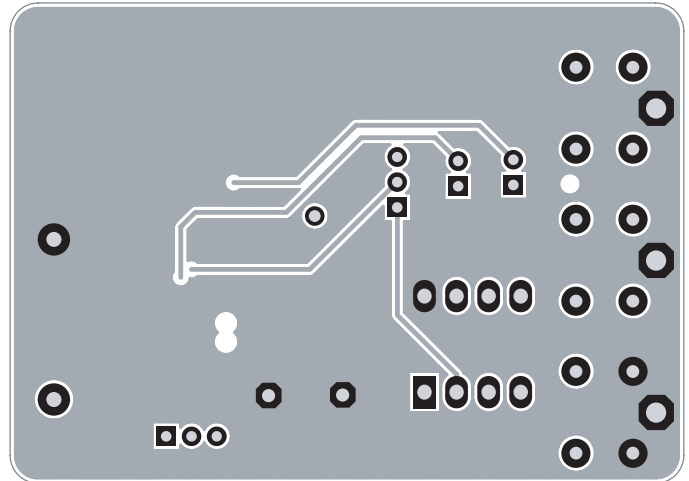

Figure 5: AAT1270 Evaluation Board Second Layer.

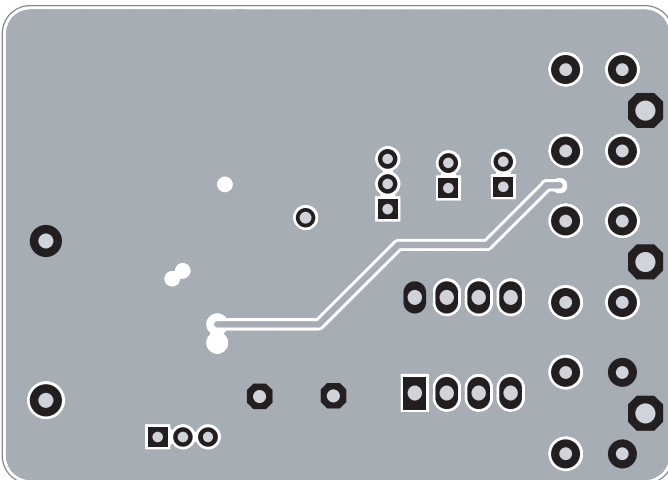

Figure 6: AAT1270 Evaluation Board Third Layer.

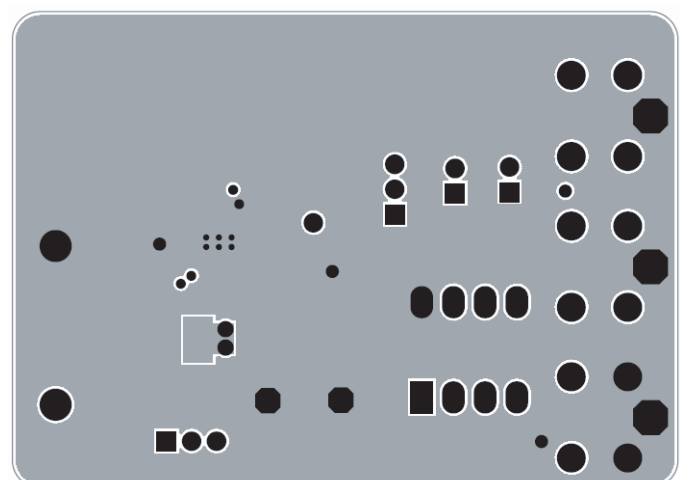

Figure 7: AAT1270 Evaluation Board Bottom Side Layout.

AAT1270**1A Step-Up Current Regulator for Flash LEDs**

Component	Part Number	Description	Manufacturer
U1	AAT1270IFO	1A Step-Up Current Regulator for Flash LEDs; STDFN33-14 package	Skyworks
U2	PIC12F675	8-bit CMOS, FLASH-based μ C; 8-pin PDIP package	Microchip
SW1-SW3	PTS645TL50	Switch Tact, SPST, 5mm	ITT Industries
R1	Chip Resistor	162k Ω , 1%, 1/4W; 0402	Vishay
R2, R3, R4	Chip Resistor	100k Ω , 1%, 1/4W; 0603	Vishay
R5, R8	Chip Resistor	10k Ω , 5%, 1/4W; 0603	Vishay
R6, R7	Chip Resistor	330 Ω , 5%, 1/4W; 0603	Vishay
JP1, JP2, JP7	Chip Resistor	0 Ω , 5%	Vishay
C1, C2	GRM188R71A225KE15	2.2 μ F, 10V, X7R, 0603	Murata
C3	GRM155R71A473KA01	47nF, 10V, X7R, 0402	Murata
C4	GRM216R61A105KA01	1 μ F, 10V, X5R, 0805	Murata
L1	LQM2HPN1R0MG0	Multilayer, 1 μ H, 1.6A, 55m Ω	Murata
D1-D2	LXCL-PWF1	White Flash LED	Lumileds, Philips
LED1	CMD15-21SRC/TR8	Red LED; 1206	Chicago Miniature Lamp
LED2	CMD15-21VGC/TR8	Green LED; 1206	Chicago Miniature Lamp
JP3, JP4, JP5, JP6	PRPN401PAEN	Conn. Header, 2mm zip	Sullins Electronics

Table 4: AAT1270 Evaluation Board Bill of Materials.

1A Step-Up Current Regulator for Flash LEDs

Ordering Information

Package	Marking ¹	Part Number (Tape and Reel) ²
STDFN33-14	XXXYY	AAT1270IFO-T1



Skyworks Green™ products are compliant with all applicable legislation and are halogen-free. For additional information, refer to *Skyworks Definition of Green™*, document number SQ04-0074.

Package Information³

STDFN33-14

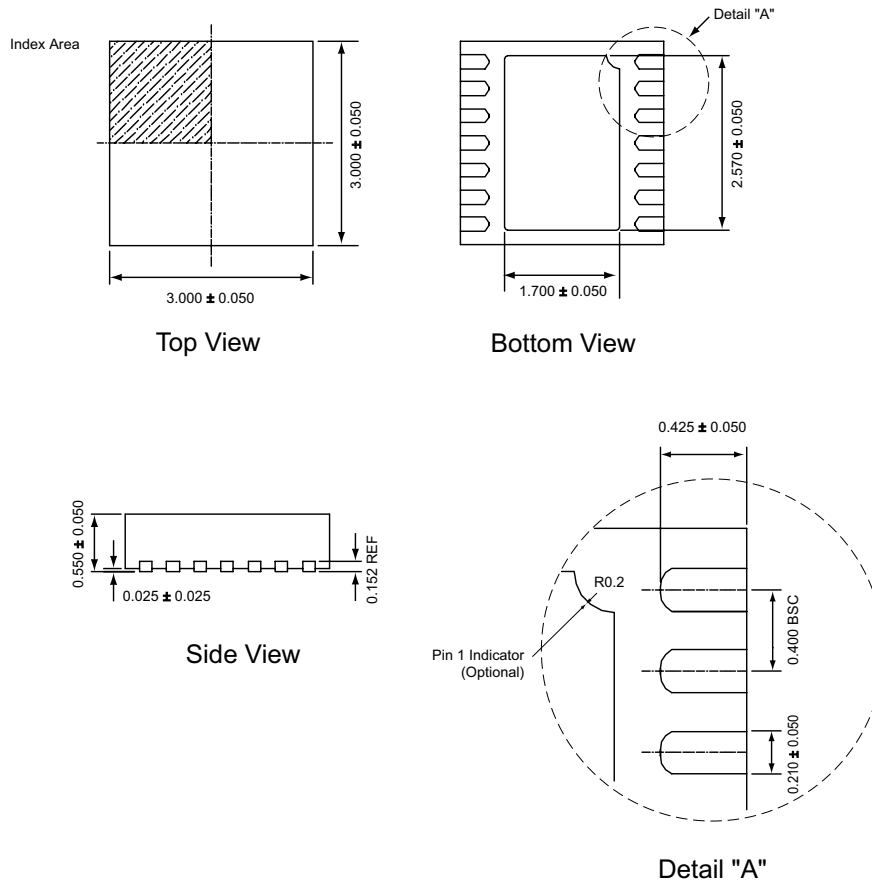

All dimensions in millimeters.

1. XYY = assembly and date code.
 2. Sample stock is generally held on part numbers listed in **BOLD**.
 3. The leadless package family, which includes QFN, TQFN, DFN, TDFN, and STDFN, has exposed copper (unplated) at the end of the lead terminals due to the manufacturing process. A solder fillet at the exposed copper edge cannot be guaranteed and is not required to ensure a proper bottom solder connection.

1A Step-Up Current Regulator for Flash LEDs

Copyright © 2012 Skyworks Solutions, Inc. All Rights Reserved.

Information in this document is provided in connection with Skyworks Solutions, Inc. ("Skyworks") products or services. These materials, including the information contained herein, are provided by Skyworks as a service to its customers and may be used for informational purposes only by the customer. Skyworks assumes no responsibility for errors or omissions in these materials or the information contained herein. Skyworks may change its documentation, products, services, specifications or product descriptions at any time, without notice. Skyworks makes no commitment to update the materials or information and shall have no responsibility whatsoever for conflicts, incompatibilities, or other difficulties arising from any future changes.

No license, whether express, implied, by estoppel or otherwise, is granted to any intellectual property rights by this document. Skyworks assumes no liability for any materials, products or information provided hereunder, including the sale, distribution, reproduction or use of Skyworks products, information or materials, except as may be provided in Skyworks Terms and Conditions of Sale.

THE MATERIALS, PRODUCTS AND INFORMATION ARE PROVIDED "AS IS" WITHOUT WARRANTY OF ANY KIND, WHETHER EXPRESS, IMPLIED, STATUTORY, OR OTHERWISE, INCLUDING FITNESS FOR A PARTICULAR PURPOSE OR USE, MERCHANTABILITY, PERFORMANCE, QUALITY OR NON-INFRINGEMENT OF ANY INTELLECTUAL PROPERTY RIGHT; ALL SUCH WARRANTIES ARE HEREBY EXPRESSLY DISCLAIMED. SKYWORKS DOES NOT WARRANT THE ACCURACY OR COMPLETENESS OF THE INFORMATION, TEXT, GRAPHICS OR OTHER ITEMS CONTAINED WITHIN THESE MATERIALS. SKYWORKS SHALL NOT BE LIABLE FOR ANY DAMAGES, INCLUDING BUT NOT LIMITED TO ANY SPECIAL, INDIRECT, INCIDENTAL, STATUTORY, OR CONSEQUENTIAL DAMAGES, INCLUDING WITHOUT LIMITATION, LOST REVENUES OR LOST PROFITS THAT MAY RESULT FROM THE USE OF THE MATERIALS OR INFORMATION, WHETHER OR NOT THE RECIPIENT OF MATERIALS HAS BEEN ADVISED OF THE POSSIBILITY OF SUCH DAMAGE.

Skyworks products are not intended for use in medical, lifesaving or life-sustaining applications, or other equipment in which the failure of the Skyworks products could lead to personal injury, death, physical or environmental damage. Skyworks customers using or selling Skyworks products for use in such applications do so at their own risk and agree to fully indemnify Skyworks for any damages resulting from such improper use or sale.

Customers are responsible for their products and applications using Skyworks products, which may deviate from published specifications as a result of design defects, errors, or operation of products outside of published parameters or design specifications. Customers should include design and operating safeguards to minimize these and other risks. Skyworks assumes no liability for applications assistance, customer product design, or damage to any equipment resulting from the use of Skyworks products outside of stated published specifications or parameters.

Skyworks, the Skyworks symbol, and "Breakthrough Simplicity" are trademarks or registered trademarks of Skyworks Solutions, Inc., in the United States and other countries. Third-party brands and names are for identification purposes only, and are the property of their respective owners. Additional information, including relevant terms and conditions, posted at www.skyworksinc.com, are incorporated by reference.