

1/4-28 X .38 [9.6] DEEP (4 STANDOFFS) FOR MOUNTING BOLTS

OPTIONAL TERMINALS FOR PUSH ON OR SOLDER CONNECTIONS (.032 X .250)

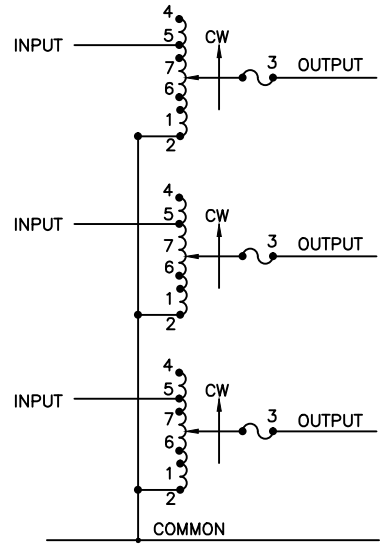

SCHEMATIC

NOTE: FUSE RECOMMENDED BUT NOT SUPPLIED

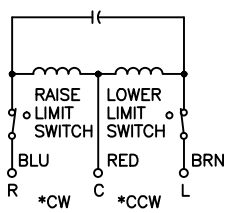

MOTOR CIRCUIT  
 120V, 50/60 HZ  
 \* ROTATION AS VIEWED FROM MOTOR END  
 MOTOR SPEED: 60 SEC.

NOTES:

- # MAXIMUM OUTPUT CURRENT IN OUTPUT VOLTAGE RANGE FROM 0 TO 25% ABOVE LINE VOLTAGE. AT HIGHER OUTPUT VOLTAGES, THE OUTPUT CURRENT MUST BE REDUCED ACCORDING TO THE DERATING CURVE FIGURE A, PAGE 16, STACO GC-4 CATALOG.
- ¶ IF GANGED UNITS ARE USED IN A SYSTEM THAT ORDINARILY HAS A COMMON NEUTRAL OR GROUND BETWEEN SOURCE AND LOAD, THE NEUTRAL OR GROUND MUST BE CONNECTED TO THE COMMON TERMINALS OF THE VARIABLE TRANSFORMER ASSEMBLY. IF THE SYSTEM HAS NO NEUTRAL, THE LOAD MUST BE BALANCED OR THE TRANSFORMERS WILL BE DAMAGED.
- § MAXIMUM KVA AT MAXIMUM OUTPUT VOLTAGE AND CORRESPONDING DERATED OUTPUT CURRENT. MAXIMUM KVA FOR LOWER VOLTAGES MAY BE CALCULATED FROM DERATING CURVE FIGURE A, PAGE 16, STACO GC-4 CATALOG.
- JUMPER PROVIDED IN THE STANDARD COMMON POSITION AND SHOULD BE MOVED OR REMOVED AS REQUIRED.

SPECIFICATIONS											
WIRING	INPUT		OUTPUT				SHAFT ROTATION TO INCREASE VOLTAGE	TERMINAL CONNECTIONS			
	VOLTS	HERTZ	VOLTS	CONSTANT CURRENT LOAD		CONSTANT IMPEDANCE LOAD		FOR INCREASING VOLTAGE AS VIEWED FROM BASE END			
				MAX. AMPS	MAX. KVA	MAX. AMPS		MAX. KVA	INPUT	JUMPER	OUTPUT
THREE PHASE WYE ¶	480	50/60	0-480	9.5	7.90	12	10	CW	2-2-2	4-4-4	3-3-3
		60	0-560	9.5	9.21	—	—	CCW	4-4-4	2-2-2	3-3-3
	240	60	0-560	9.5#	3.96§	—	—	CW	1-1-1	4-4-4	3-3-3
								CCW	5-5-5	2-2-2	3-3-3
								CW	7-7-7	4-4-4	3-3-3
								CCW	6-6-6	2-2-2	3-3-3

UNLESS OTHERWISE SPECIFIED, TOLERANCE IS ±	DECIMALS	HOLES	ANGLES	DRAFT	UNITS
.XX	±.06	.002	1°	1-1/2°	IN [mm]
.XXX	.005				ALL DIMENSIONS APPLY AFTER PLATING

TITLE: SPEC. CONTROL DWG.  
 VARIABLE TRANSFORMER  
 TYPE: 60M1520-3



DRAWN BY TIM RAU	DATE 12/15/95	FIRST USED ON	DO NOT SCALE DWG.	CUSTOMER APPROVAL	DATE
CHECKER	DATE	WEIGHT APPROX.	CODE IDENT. NO. 83008	DWG. NO. 031-4068	
ENGINEER	DATE	SCALE .5=1	SHEET 1 OF 1		