

LED Driver

Indoor 30w Compact Driver

Non-Dimming : SI-CU55230N1WW

Dimming : SI-CU5523001WW



Constant Current LED Driver

Features & Benefits

- Output Current Range: 0.275~0.555 A (adjustable via R-set)
- Output Voltage Range: MAX 54 Vdc
- Output Power Range: Max 30 W
- Dimming Control: 0-10 V (Min. 3.5%)
- Input Voltage: 120 ~ 277 Vac, 50/60 Hz
- Safety: UL / cUL (UL 8750, UL Class 2)
- EMI: FCC Part 15 Class B
- Protections: Short Circuit, Over Voltage (Auto Recovery)
- t_a Range: -20 ~ +50 °C
- Expected lifetime: 50,000 hours at $t_c < 65$ °C
- Long lasting & high reliability
- Metal housing



Applications

- Indoor lighting

Table of Contents

| | | | |
|----|--------------------------------|-------|----|
| 1. | Characteristics | ----- | 3 |
| 2. | Typical Characteristics Graphs | ----- | 5 |
| 3. | Protection | ----- | 6 |
| 4. | Dimming Specification | ----- | 6 |
| 5. | Reliability & standard | ----- | 7 |
| 6. | Outline Drawing & Dimension | ----- | 8 |
| 7. | Label Structure | ----- | 8 |
| 8. | Packing Structure | ----- | 9 |
| 9. | Precautions in Handling & Use | ----- | 10 |

1. Characteristics

| Article | Symbol | Specification | | | Unit | Note |
|------------------------------|------------|---------------|---------|-------|------|--|
| | | Min. | Typ. | Max. | | |
| INPUT SPECIFICATIONS | | | | | | |
| Nominal Voltage | Vin | 120 | | 277 | Vac | |
| Voltage Range | | 108 | | 300 | Vac | |
| Nominal Frequency | Fin | | 50 / 60 | | Hz | |
| Frequency Range | | 47 | | 63 | Hz | |
| Input Current | At 120 Vac | lin | | 0.35 | A | At full load |
| | At 277 Vac | lin | | 0.15 | A | At full load |
| Total Harmonic Distortion | THD | | | 20 | % | At 120-277 Vac |
| Power Factor | PF | 0.9 | | | - | At 120-277 Vac |
| Efficiency | | 86 | 87 | | % | At full load, 120 Vac, 60 Hz At full load, 277 Vac, 60 Hz |
| | | 86 | 88 | | | |
| In-rush Current | | | | 30 | Apk | NEMA410. |
| OUTPUT SPECIFICATIONS | | | | | | |
| Voltage Range | Vo | 37 | | 54 | Vdc | 70% of MAX power can meet PF,THD |
| Max. Voltage | | | | 60 | Vdc | Open circuit, No-load protection |
| Current Range | Io | 0.275 | | 0.555 | A | 70% of MAX power can meet PF,THD |
| Line Regulation | | -3 | | 3 | % | @120~277Vac |
| Load Regulation | | -5 | | 5 | % | @120~277Vac, W/O dimming |
| Current Tolerance | | -5 | | 5 | % | @120~277Vac, W/O dimming |
| Ripple Current | | | | 50% | % | $\frac{1}{I_{avg}}(I_{peak} - I_{avg}) \times 100\%$ |
| Peak current | | | | 150% | | $\frac{I_{peak}}{I_{avg}} \times 100\%$ |
| Nominal Power | Po | | | 30 | W | |
| Turn-on Delay Time | Td | | | 1 | s | @120Vac, W/O dimmer |

- 1) PF, THD, FCC can meet the electrical performance from 70% of MAX power.
- 2) Measured the unit is thermally stabilized after half an hour, Ta 25°C.

| Article | Symbol | Specification | | | Unit | Note |
|------------------------------|-----------|---------------|---------------|------|------|---------------------------------------|
| | | Min. | Typ. | Max. | | |
| DIMMING SPECIFICATIONS | | 3.5 | | 100 | % | @555mA |
| Dimming Control | | | 0-10 V | | | See Dimming Specification section |
| ENVIRONMENTAL SPECIFICATIONS | | | | | | |
| Ambient Temperature | ta | -20 | | 50 | °C | |
| Case Temperature | tc | | | 75 | °C | Type TL 75 °C / 65 °C |
| Storage Temperature | ts | -40 | | 85 | °C | |
| Ambient Humidity | | 10 | | 90 | % | Not condensing |
| Surge Transient Protection | L / N | | | ±2.5 | kV | ANSI/IEEE C62.41 100KHz Ring Wave |
| | LN / GND | | | ±2.5 | kV | |
| IP Rating | | | 20 | | - | Suitable for indoor environment |
| Expected Lifetime (e-cap) | | 50,000 | | | h | At tc < 65 °C, full load, 120-277 Vac |
| MTBF | | 500,000 | | | h | Ta=25°C, Telcordia SR-332, Method I |
| Dimensions | L x W x H | | 165 x 43 x 32 | | mm | |
| Net Weight | | | 195 | | g | |

2. Typical Characteristics Graphs

a) Operating Window

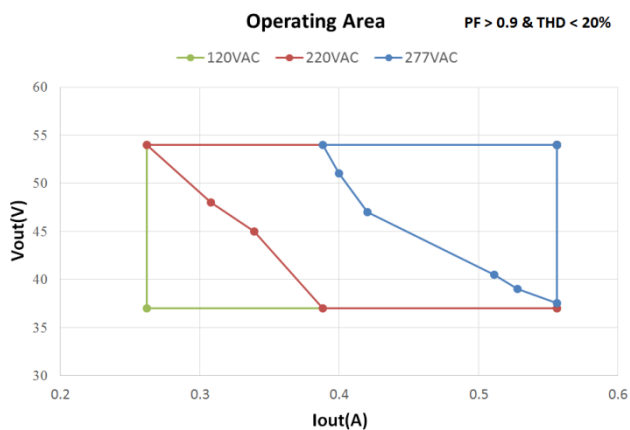

b) Efficiency vs. Load

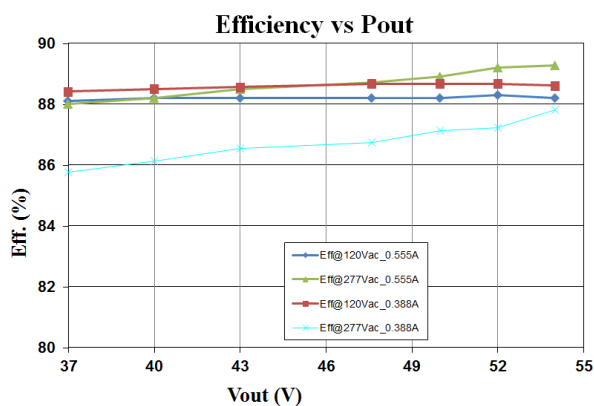

c) Power Factor vs. Load

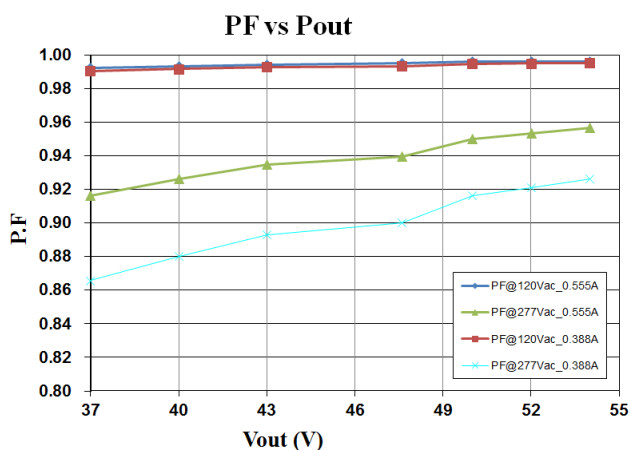

d) Total Harmonic Distortion vs. Load

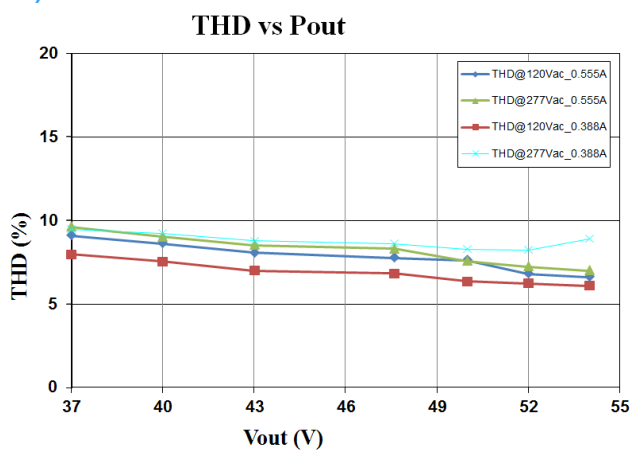

e) Life time

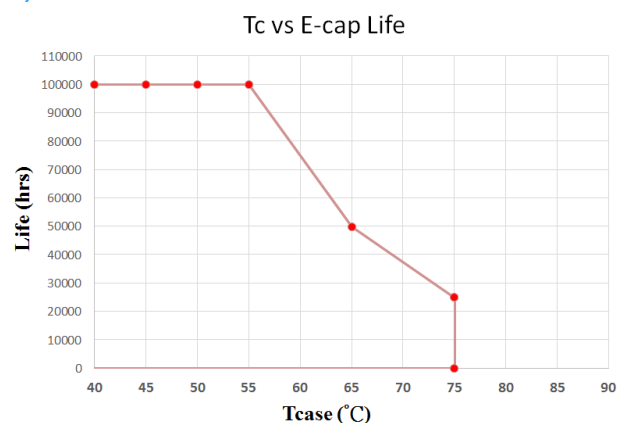

f) Ta vs. Load

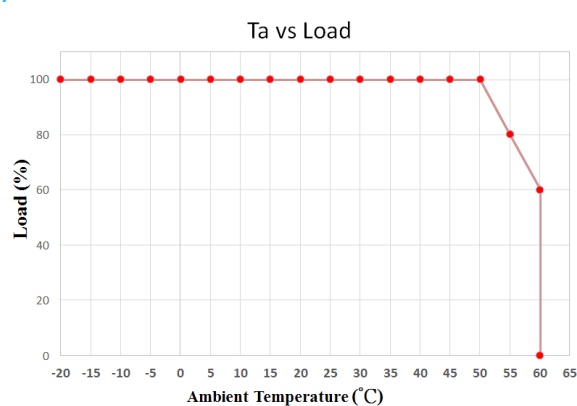

g) R-set Table

| Rset (Kohm) | Iout(A) | Iout(%) |
|-------------|---------|---------|
| 0.00 | 0.2689 | 48.5 |
| 0.10 | 0.2737 | 49.3 |
| 0.33 | 0.2841 | 51.2 |
| 0.68 | 0.2985 | 53.8 |
| 1.05 | 0.3122 | 56.2 |
| 1.43 | 0.3248 | 58.5 |
| 1.87 | 0.3378 | 60.9 |
| 2.00 | 0.3414 | 61.5 |
| 2.32 | 0.3497 | 63.0 |
| 2.87 | 0.3625 | 65.3 |
| 3.48 | 0.3750 | 67.6 |
| 3.83 | 0.3815 | 68.7 |
| 4.22 | 0.3882 | 69.9 |
| 4.99 | 0.3999 | 72.1 |
| 5.62 | 0.4084 | 73.6 |
| 6.49 | 0.4187 | 75.4 |
| 7.15 | 0.4255 | 76.7 |
| 7.68 | 0.4306 | 77.6 |
| 8.87 | 0.4406 | 79.4 |
| 10.00 | 0.4487 | 80.8 |
| 10.50 | 0.4519 | 81.4 |
| 12.40 | 0.4625 | 83.3 |
| 14.30 | 0.4712 | 84.9 |
| 16.90 | 0.4807 | 86.6 |
| 20.00 | 0.4895 | 88.2 |
| 24.90 | 0.4998 | 90.1 |
| 30.10 | 0.5077 | 91.5 |
| 39.20 | 0.5171 | 93.2 |
| 53.60 | 0.5261 | 94.8 |
| 76.80 | 0.5341 | 96.2 |
| 100.00 | 0.5385 | 97.0 |
| 130.00 | 0.5420 | 97.7 |
| 205.00 | 0.5464 | 98.4 |
| Open | 0.5550 | 100.0 |

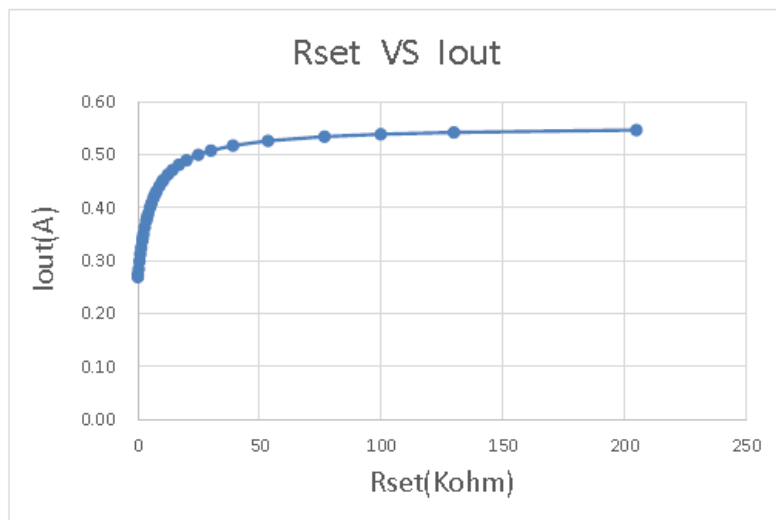

3. Protection

a) Output Short Circuit Protection

The unit is protected when output is short thus avoiding safety hazard, shock hazard and damage to the unit. After the short circuit fault condition is removed, the unit will enter the auto-recovery mode.

b) Output Over Voltage Protection (Output Open Load Protection)

When no load condition occurs, the unit will clamp output voltage to the OVP Voltage avoiding damage to the unit. After the load is connected, the unit will enter the auto-recovery mode.

The OVP Voltage varies according to the Rset resistor value (see below curve and table) and under 60 V.

4. Diming Specification

1) Control Type : 0-10V

The unit has Analog Dimming (AD) function, using 0-10 Vdc. The typical dimming curve is shown below. The dimming curve is tested with LED electronic load Chroma 63115A/6312A. Rd coefficient is 0.1.

| | Symbol | Unit | Min | Typ | Max | Remark |
|---------|-----------|------|-----|-----|-----|--------------------------|
| Dimming | Range | V | 0 | | 10 | |
| | Dim off | V | 0 | | 0.5 | Hysteresis to Dim > 0.8V |
| | Dim. Min. | V | 0.6 | 1 | 1.6 | |
| | Dim Max. | V | 9.2 | | 10 | |

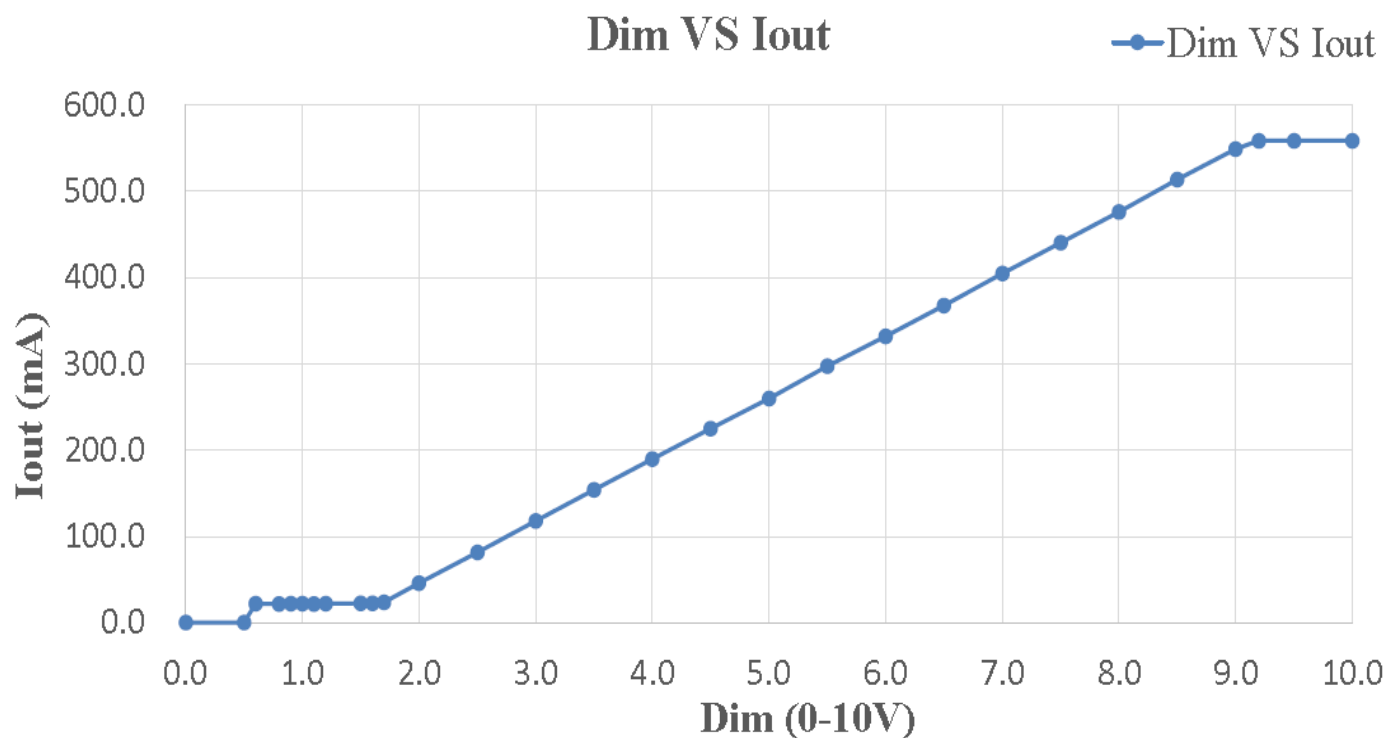

5. Reliability & Standards

Test Items and Conditions

| Test Item | | Specification | Condition |
|-----------------------|----------------|--|-----------------------------------|
| Leakage Current | | < 0.7 mA | 305Vac, IEC 60598-1 |
| Earth Continuity | | < 0.5 Ω | IEC 61347-2-13 |
| Hi-Pot | Input – Output | 3750 Vac, 60 s, cut-off current 10 mA | 100 % tested in production line |
| | Input – F.G | 1857 Vac, 60 s, cut-off current 10 mA | 100 % tested in production line |
| | Output – F.G | 1500 Vac, 60 s, cut-off current 10 mA | 100 % tested in production line |
| Insulation Resistance | Input – Output | 500 Vdc, 60 s, insulation resistance 10 M Ω | 100 % tested in production line |
| Surge | L / N | ± 2.5 kV | ANSI/IEEE C62.41 100KHz Ring Wave |
| | L-N / GND | ± 2.5 kV | |
| ESD | Contact | ± 4 kV | EN61547(IEC 61000-4-2) |
| | Air | ± 8 kV | |

Safety, EMI and EMC

| International Standard | Certification |
|---|---------------------------------|
| UL Safety Standards (Class 2 Output) | UL8750 |
| EMC | Comply with FCC Part 15 Class B |
| Harmonic current emissions: Class C | Comply with IEC/EN 61000-3-2 |
| Electrostatic Discharge (ESD): Contact 4kV, Air 8kV | Comply with IEC/EN 61000-4-2 |
| Radio-frequency Electromagnetic Fields | Comply with IEC/EN 61000-4-3 |
| Electrical Fast Transients (EFT) | Comply with IEC/EN 61000-4-4 |
| Surges: Differential 1kV, Common 2kV | Comply with IEC/EN 61000-4-5 |
| Injected Currents, Conducted disturbances induced by Radio-Frequency fields | Comply with IEC/EN 61000-4-6 |
| Voltage Dips and Short Interruptions (Class B) | Comply with IEC/EN 61000-4-11 |

6. Outline Drawing & Dimension

Dimension : 165 (L) x 43 (W) x 32 (H) Unit: mm

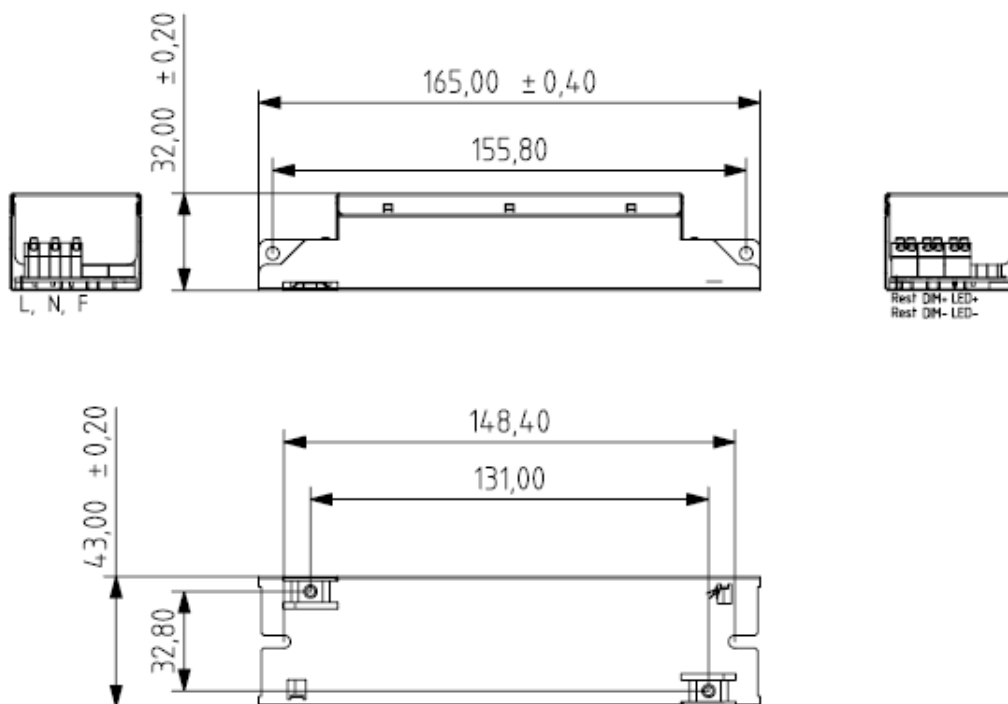

7. Label Structure

| | | | |
|--------------------------|------------------------------------|---|---|
| L 0.75 ~ 1.25 □ N | LED POWER SUPPLY | SAMSUNG E470825 9mm wire preparation 0.5 ~ 1.25mm ² /AWG 16 - 20 | tc : 75°C Type TL 75/65°C LED+ 0.5 ~ 1.25 □ LED- AD+ AD- Rset Rset |
| | MODEL: SI-CU5523001WW | | |
| | P/N: SX030G001LD | | |
| | INPUT : 120 – 277V ~ 0.35A 50/60Hz | | |
| | OUTPUT : 37 – 54V/0.555A 30W max | | |
| | CONSTANT CURRENT , SELV | | |
| | POWER FACTOR (PF) : > 0.9 | | |
| | DIMMER INTERFACE : 0 – 10V | | |
| | TA : 50°C | | |
| | MADE in China | | |
| | Class 2 Power Unit Ver.1.1 | | |

0-10 Dimming

| | | | |
|--------------------------|------------------------------------|---|---|
| L 0.75 ~ 1.25 □ N | LED POWER SUPPLY | SAMSUNG E470825 9mm wire preparation 0.5 ~ 1.25mm ² /AWG 16 - 20 | tc : 75°C Type TL 75/65°C LED+ 0.5 ~ 1.25 □ LED- Rset Rset |
| | MODEL: SI-CU55230N1WW | | |
| | P/N: SX030G001ND | | |
| | INPUT : 120 – 277V ~ 0.35A 50/60Hz | | |
| | OUTPUT: 37 – 54V/0.555A 30W max | | |
| | CONSTANT CURRENT , SELV | | |
| | POWER FACTOR (PF) : > 0.9 | | |
| | TA : 50°C | | |
| | MADE in China | | |
| | Class 2 Power Unit Ver.1.1 | | |

Non- Dimming

8. Packing Structure

| Packing material | Max. quantity (pcs) | Dimension (mm) | | |
|------------------|----------------------|----------------|-------|--------|
| | | Length | Width | Height |
| Outer Box | 24 | 400 | 300 | 170 |
| Pallet | 960 (40 outer boxes) | 1,200 | 1,000 | 1110 |

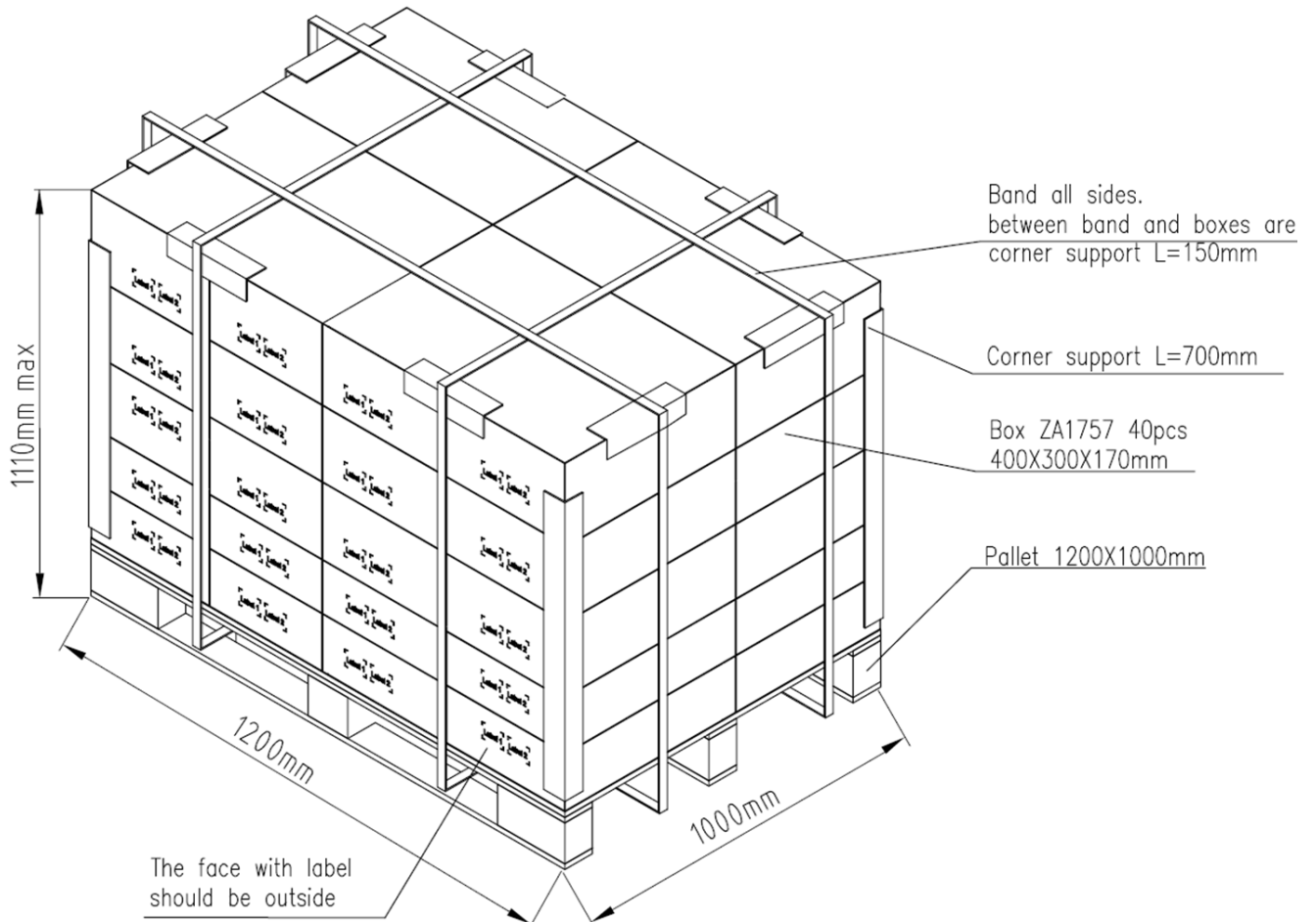

9. Precautions in Handling & Use

- 1) To prevent the LED Driver from any defect, please handle and store it with care
 - Do not drop or give shock
 - Do not store in very humid location or at extreme temperature
 - Do not open or disassemble the product
- 2) Static electricity or surge voltage may damage the components inside LED Driver, as such please observe proper anti-electrostatic working process
 - People handling the Driver should be well grounded (e.g. using ESD wrist band) and wear anti-static working clothes and gloves
 - All related devices and instruments in the production line should be well grounded (e.g. working table, measuring equipment, assembly jigs)
- 3) Observe the correct polarity of output terminal
- 4) Avoid input voltage exceeds the maximum rating, which will cause damage to the circuit and result in malfunction

Legal and additional information.

[About Samsung Electronics Co., Ltd.](#)

Samsung Electronics Co., Ltd. inspires the world and shapes the future with transformative ideas and technologies, redefining the worlds of TVs, smartphones, wearable devices, tablets, cameras, digital appliances, printers, medical equipment, network systems and semiconductors.

We are also leading in the Internet of Things space through, among others, our Digital Health and Smart Home initiatives. We employ 307,000 people across 84 countries. To discover more, please visit our official website at www.samsung.com and our official blog at global.samsungtomorrow.com.

Copyright © 2015 Samsung Electronics Co., Ltd. All rights reserved.

Samsung is a registered trademark of Samsung Electronics Co., Ltd.

Specifications and designs are subject to change without notice. Non-metric weights and measurements are approximate. All data were deemed correct at time of creation. Samsung is not liable for errors or omissions. All brand, product, service names and logos are trademarks and/or registered trademarks of their respective owners and are hereby recognized and acknowledged.

Samsung Electronics Co., Ltd.

95, Samsung 2-ro

Giheung-gu

Yongin-si, Gyeonggi-do, 446-711

KOREA

www.samsungled.com

