

DATA SHEET

**ELECTROSTATIC DISCHARGE
PROTECTION DEVICES**

INDUSTRIAL / CONSUMER

SET23AXXL02 series

RoHS compliant & Halogen free



Product specification – March 20, 2021 V.2



Electrostatic Discharged Protection Devices (ESD) Data Sheet

Description

Brightking's SET23AXXL02 series are designed to protect components which are connected to data and transmission lines from voltage surges caused by electrostatic discharge (ESD), electrical fast transients (EFT) and lightning. TVS diodes are characterized by their high surge capability, low operating and clamping voltages, and fast response time. This makes them ideal for use as board level protection of sensitive semiconductor components. The low profile SOT-23 package allows flexibility in the design of crowded circuit boards.



Contact : ±30kV
Air : ±30kV



Features

- IEC61000-4-2 ESD 30KV Air, 30KV contact compliance
ESD 15KV Air, 8KV contact compliance for SET23A36L02
- SOT-23 surface mount package
- Protects one bidirectional line or two unidirectional lines
- Working voltage: 3.3V, 5V, 12V, 15V, 24V and 36V
- Low leakage current
- Low operating and clamping voltages
- Solid-state silicon avalanche technology
- Lead Free/RoHS compliant
- Solder reflow temperature: Pure Tin-Sn, 260~270°C
- Flammability rating UL 94V-0
- Meets MSL level 1, per J-STD-020

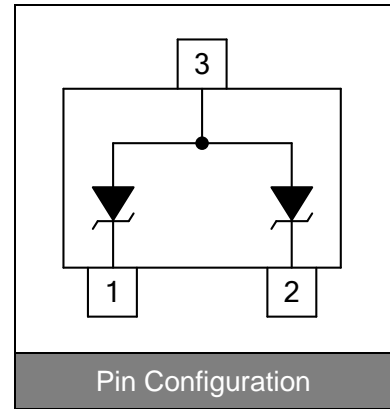

Applications

- Cellular handsets and accessories
- Personal digital assistants (PDA's)
- Portable instrumentation
- Set Top Box (STB)
- Servers, notebook, and desktop PC
- Wireless bus protection
- RS-232, RS-422, RS-423 protection

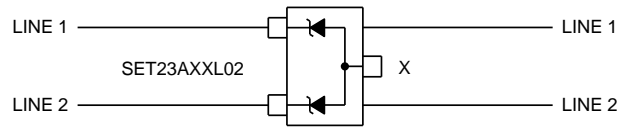

Bidirectional Protect Line

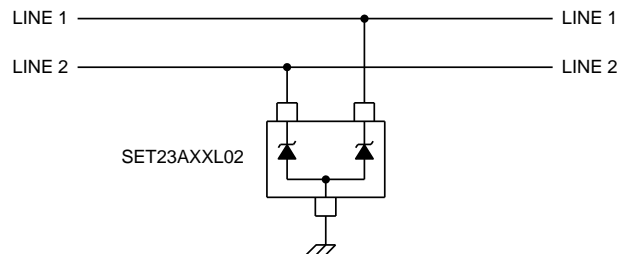

Unidirectional Protect Lines

Maximum Ratings

Rating	Symbol	Value	Unit
ESD voltage (Contact discharge)	V_{ESD}	± 8	kV
ESD voltage (Air discharge)		± 15	
Storage & operating temperature range	T_{STG}, T_J	-55~+150	°C

Electrical Characteristics (T_J=25°C)

SET23A03L02 (Marking: B 03C)

Parameter	Symbol	Condition	Min.	Typ.	Max.	Unit
Reverse stand-off voltage	V _{RWM}				3.3	V
Reverse breakdown voltage	V _{BR}	I _{BR} =1mA	4			V
Reverse leakage current	I _R	V _R =3.3V each I/O pin			125	μA
Clamping voltage (tp=8/20μs)	V _C	I _{PP} =1A			7	V
Clamping voltage (tp=8/20μs)	V _C	I _{PP} =15A			15	V
Peak Pulse Current(tp=8/20μs)	I _{PP}				15	A
Off state junction capacitance	C _J	0Vdc, f=1MHz Between I/O pins and GND		300		pF

SET23A05L02 (Marking: B 05C)

Parameter	Symbol	Condition	Min.	Typ.	Max.	Unit
Reverse stand-off voltage	V _{RWM}				5	V
Reverse breakdown voltage	V _{BR}	I _{BR} =1mA	6			V
Reverse leakage current	I _R	V _R =5V each I/O pin			5	μA
Clamping voltage (tp=8/20μs)	V _C	I _{PP} =1A			9.8	V
Clamping voltage (tp=8/20μs)	V _C	I _{PP} =15A			20	V
Peak Pulse Current(tp=8/20μs)	I _{PP}				15	A
Off state junction capacitance	C _J	0Vdc, f=1MHz Between I/O pins and GND		220		pF

SET23A12L02-E18 (Marking: B 12C)

Parameter	Symbol	Condition	Min.	Typ.	Max.	Unit
Reverse stand-off voltage	V _{RWM}				12	V
Reverse breakdown voltage	V _{BR}	I _{BR} =1mA	13.3			V
Reverse leakage current	I _R	V _R =12V Each I/O pin			1	μA
Clamping voltage (tp=8/20μs)	V _C	I _{PP} =1A			19	V
Clamping voltage (tp=8/20μs)	V _C	I _{PP} =10A			27	V
Peak Pulse Current(tp=8/20μs)	I _{PP}				18	A
Off state junction capacitance	C _J	0Vdc, f=1MHz Between I/O pins and GND		100		pF

Electrical Characteristics (T_J=25°C)

SET23A15L02 (Marking: B 15C)

Parameter	Symbol	Condition	Min.	Typ.	Max.	Unit
Reverse stand-off voltage	V _{RWM}				15	V
Reverse breakdown voltage	V _{BR}	I _{BR} =1mA	16.7			V
Reverse leakage current	I _R	V _R =15V each I/O pin			1	μA
Clamping voltage (tp=8/20μs)	V _C	I _{PP} =1A			24	V
Clamping voltage (tp=8/20μs)	V _C	I _{PP} =10A			30	V
Peak Pulse Current(tp=8/20μs)	I _{PP}				10	A
Off state junction capacitance	C _J	0Vdc, f=1MHz Between I/O pins and GND		90		pF

SET23A24L02 (Marking: B 24C)

Parameter	Symbol	Condition	Min.	Typ.	Max.	Unit
Reverse stand-off voltage	V _{RWM}				24	V
Reverse breakdown voltage	V _{BR}	I _{BR} =1mA	26.7			V
Reverse leakage current	I _R	V _R =24V each I/O pin			1	μA
Clamping voltage (tp=8/20μs)	V _C	I _{PP} =1A			43	V
Clamping voltage (tp=8/20μs)	V _C	I _{PP} =5A			49	V
Peak Pulse Current(tp=8/20μs)	I _{PP}				6	A
Off state junction capacitance	C _J	0Vdc, f=1MHz Between I/O pins and GND		80		pF

SET23A36L02 (Marking: B 36C)

Parameter	Symbol	Condition	Min.	Typ.	Max.	Unit
Reverse stand-off voltage	V _{RWM}				36	V
Reverse breakdown voltage	V _{BR}	I _{BR} =1mA	40			V
Reverse leakage current	I _R	V _R =36V each I/O pin			1	μA
Clamping voltage (tp=8/20μs)	V _C	I _{PP} =1A			51	V
Clamping voltage (tp=8/20μs)	V _C	I _{PP} =5A			76.8	V
Peak Pulse Current(tp=8/20μs)	I _{PP}				5	A
Off state junction capacitance	C _J	0Vdc, f=1MHz Between I/O pins and GND		70		pF

Typical Characteristics Curves

Figure 1. Power Derating Curve

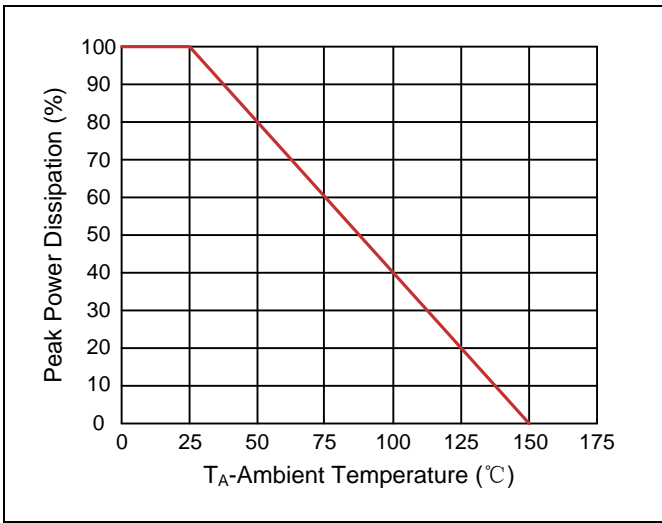

Figure 2. Pulse Waveforms

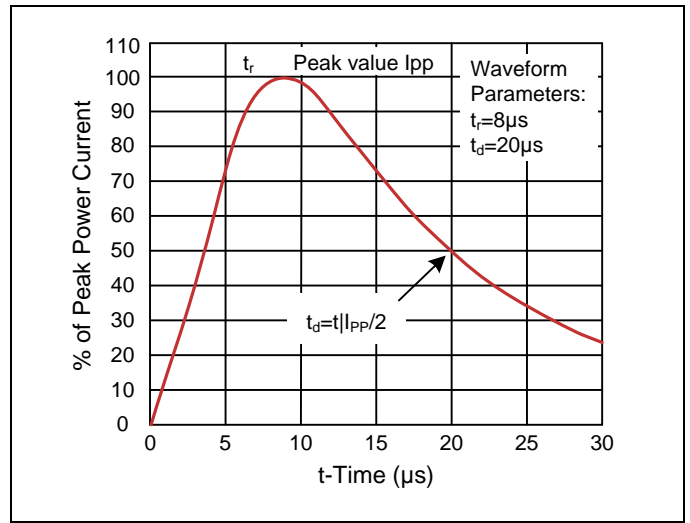

Figure 3. Forward Voltage vs. Forward Current

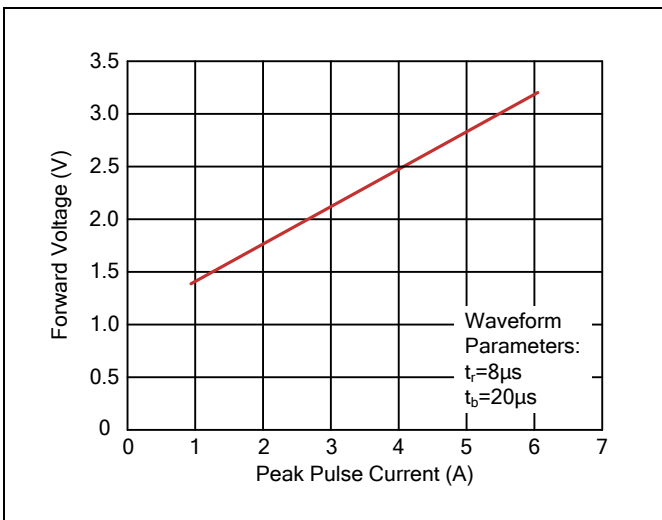
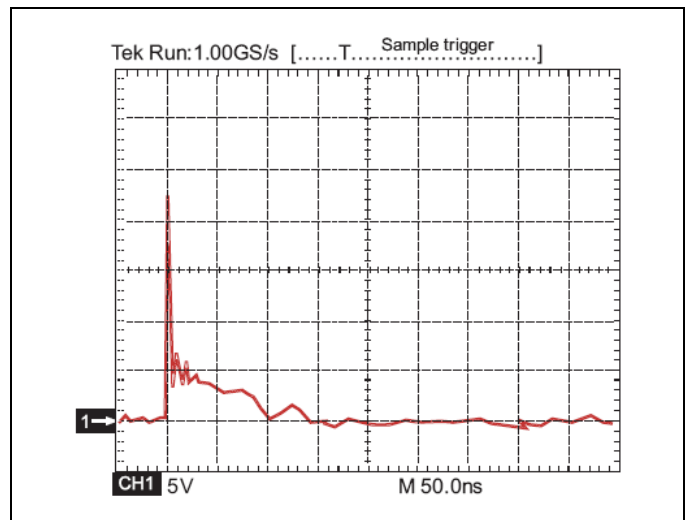
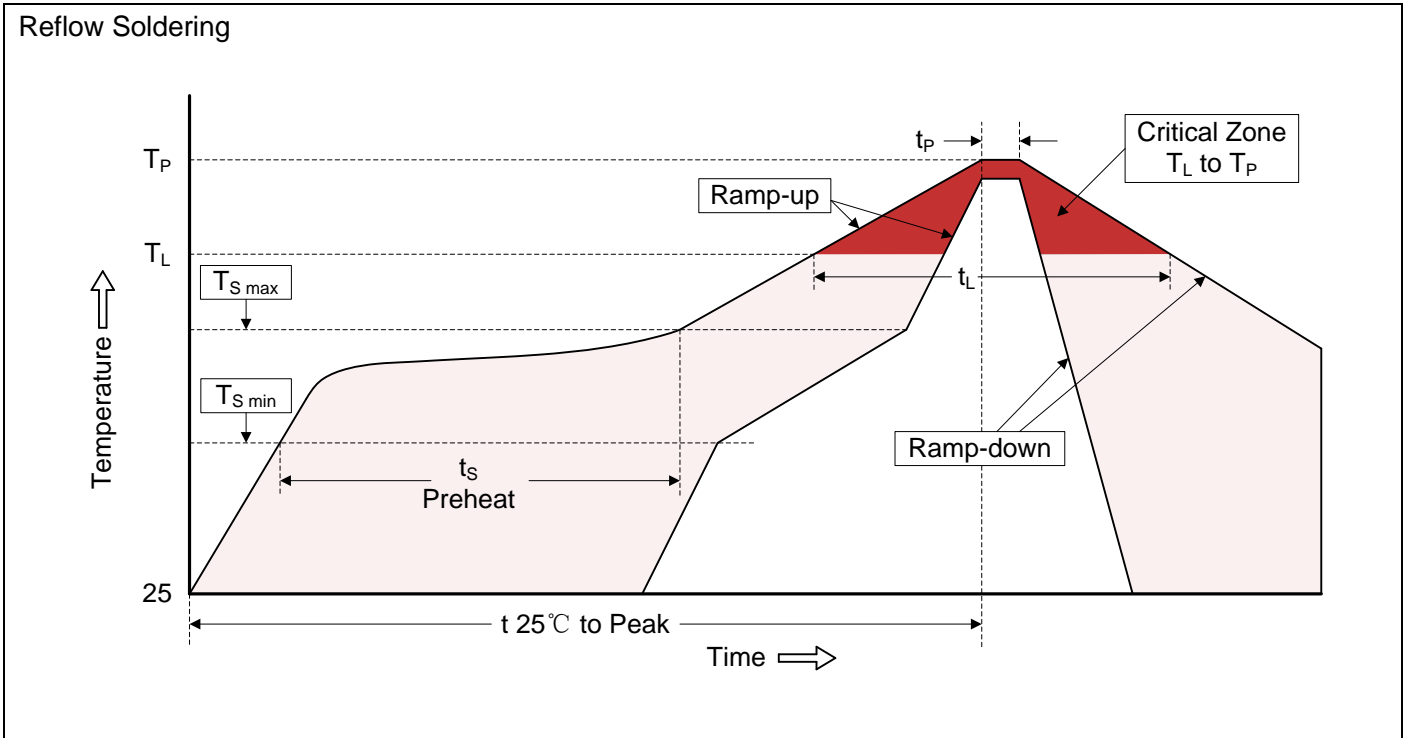

Figure 4. ESD Clamping(8kV Contact IEC61000-4-2)



Recommended Soldering Conditions



Recommended Conditions

Profile Feature	Pb-Free Assembly
Average ramp-up rate (T_L to T_P)	3°C/second max.
Preheat -Temperature Min ($T_{S\ min}$) -Temperature Max ($T_{S\ max}$) -Time (min to max) (t_s)	150°C 200°C 60-180 seconds
$T_{S\ max}$ to T_L -Ramp-up Rate	3°C/second max.
Time maintained above: -Temperature (T_L) -Time (t_L)	217°C 60-150 seconds
Peak Temperature (T_P)	260°C
Time within 5°C of actual Peak Temperature (t_P)	20-40 seconds
Ramp-down Rate	6°C/second max.
Time 25°C to Peak Temperature	8 minutes max.

Dimensions (SOT-23)

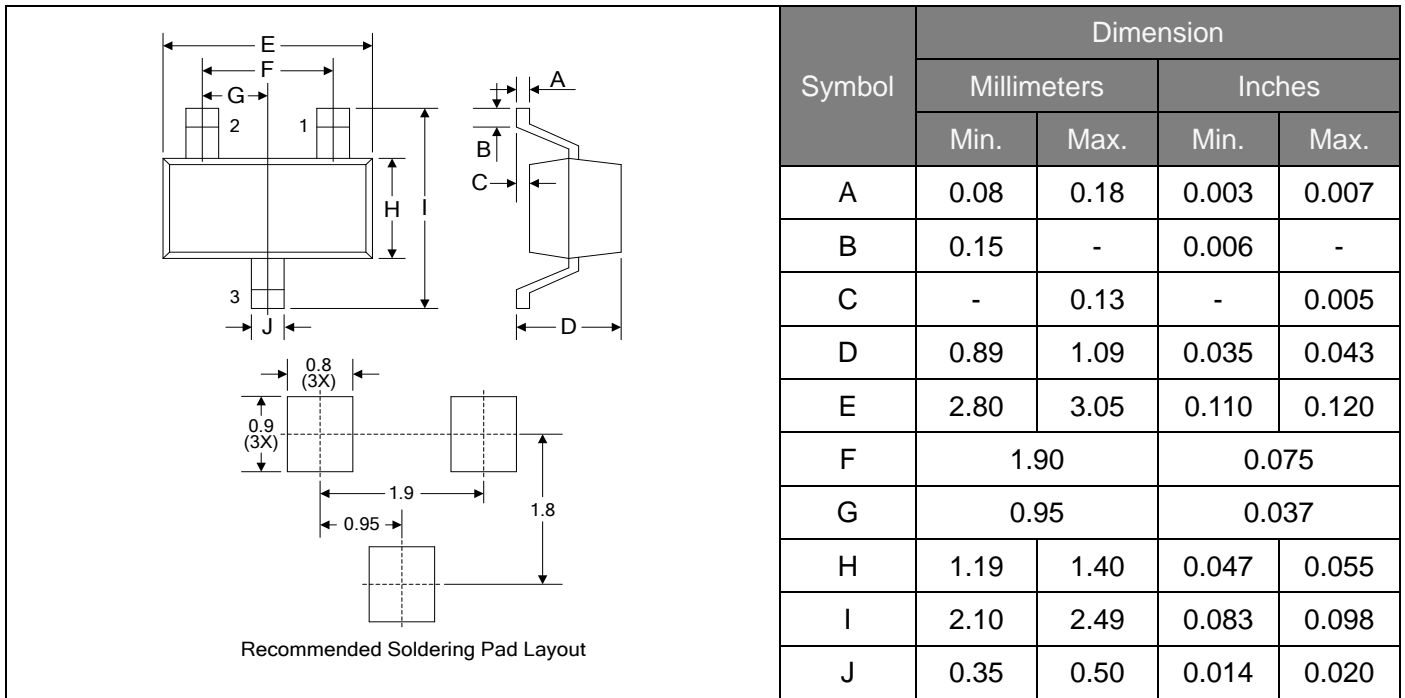

Packaging

