

DESCRIPTION: POWER - RIGHT ANGLE - MALE

**SPECIFICATIONS:**

**ELECTRICAL:**  
 INSULATOR RESISTANCE: 5,000 MegOHMS Min.  
 DIELECTRIC WITHSTANDING: 1,000VAC r.m.s.  
 OPERATING TEMPERATURE: -55° C ~ +125° C  
 CONTACT RESISTANCE: 30 MilliOHMS Max.  
 POWER PINS: 40 AMPS

**MECHANICAL:**  
 CONTACT INSERTION FORCE: 4.5 Kg Max.  
 CONTACT SEPARATOR FORCE: 0.3Kg Min.

**MATERIALS:**  
 CONTACTS: BRASS  
 INSULATOR: PBT UL94V-0 RATED, 230°C PROCESS TEMP.  
 SHELL: STEEL  
 BOARD LOCK: BRASS, NICKEL PLATED  
 CINCHNUT: BRASS, NICKEL PLATED  
 BRACKET: STEEL, NICKEL PLATED

**FINISH:**  
 SHELL: NICKEL

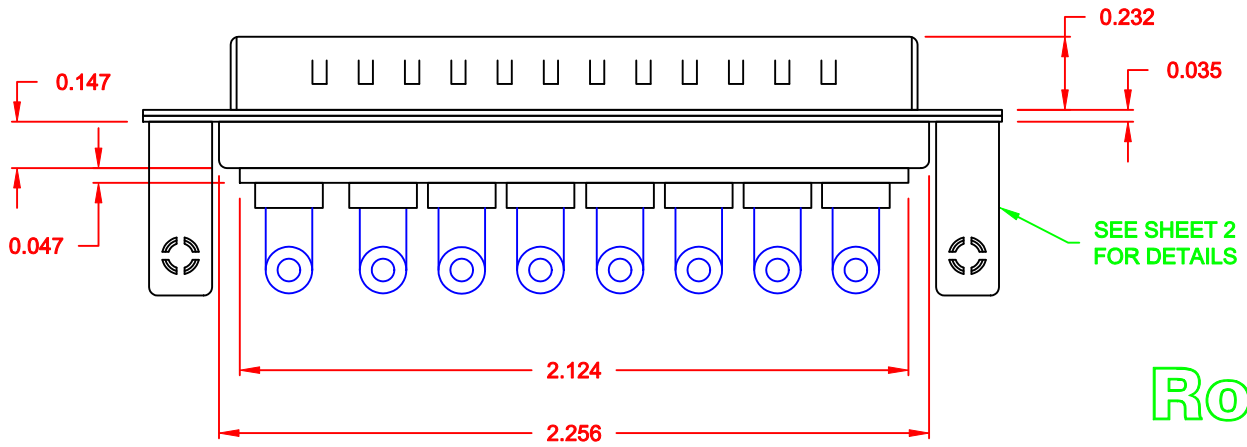
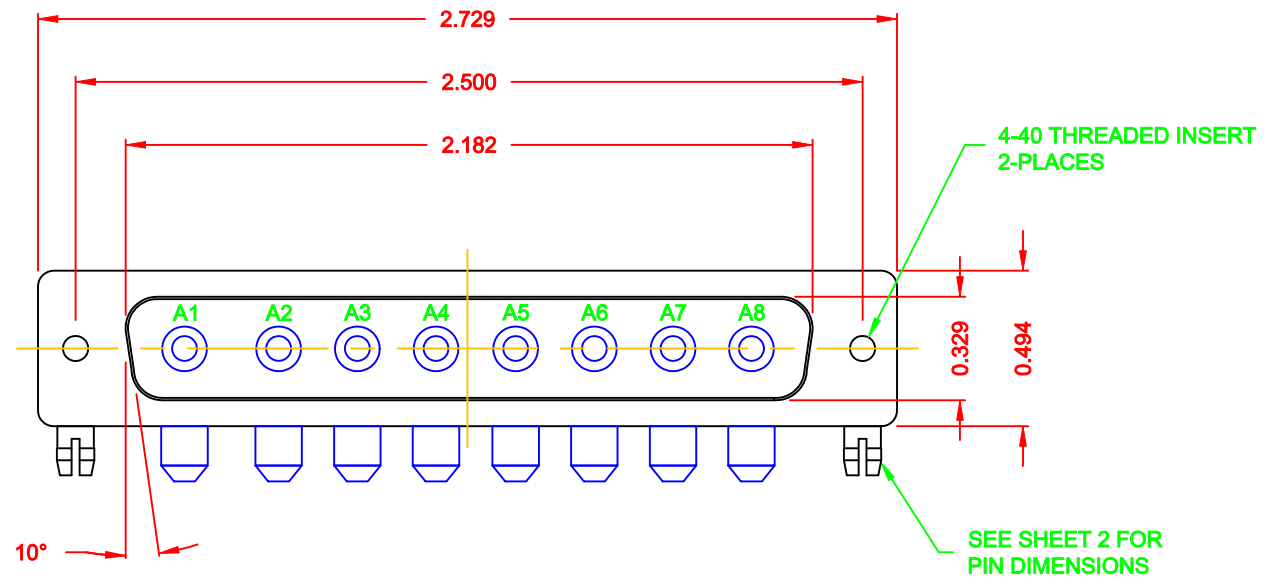

**6848W8103L461**

46 = 4-40 INSERTS / BOARD LOCKS

**RoHS COMPLIANT**

	THESE DRAWINGS AND SPECIFICATIONS ARE THE PROPERTY OF NorComp AND SHALL NOT BE REPRODUCED, COPIED OR USED AS THE BASIS FOR THE MANUFACTURE OR SALE OF APPARATUS WITHOUT WRITTEN PERMISSION.		DRAWN: <b>C. SMITH</b>	DATE: <b>10-06-06</b>
			CHECKED:	DATE:
<b>NorComp</b>		SCALE: <b>1.5 = 1</b>	SHEET <b>1</b> OF <b>2</b>	REV <b>3</b>
		DWG NO. <b>6848W8103L461</b>		

**NOTE:**  
**POWER CONTACTS COME**  
**PRE-LOADED INTO INSULATORS**

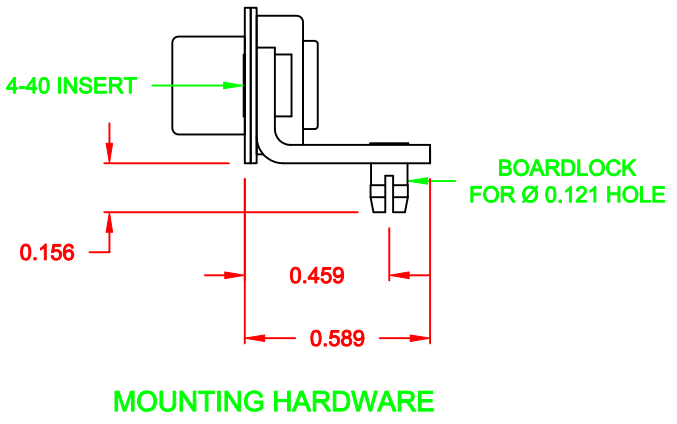
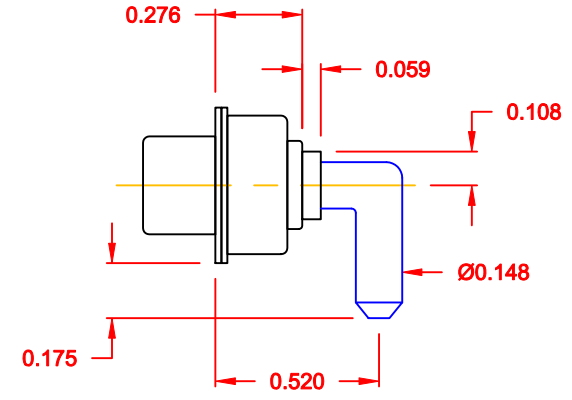
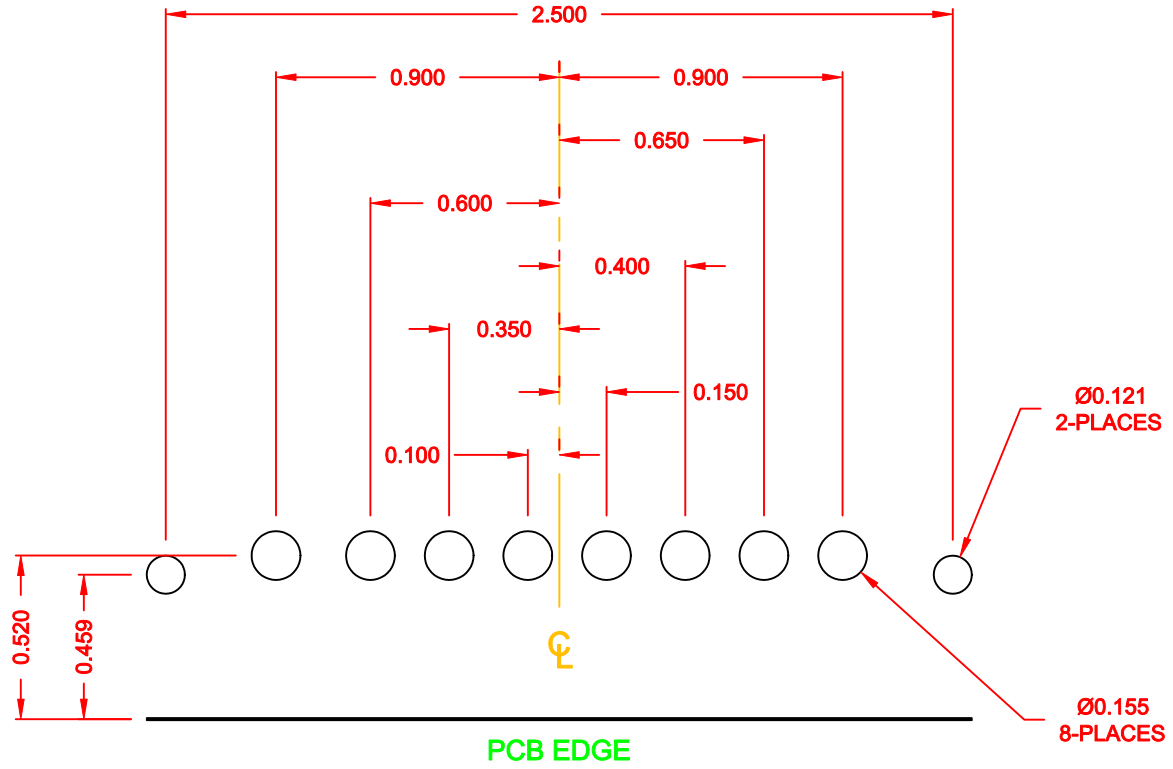

**RoHS COMPLIANT**

	THESE DRAWINGS AND SPECIFICATIONS ARE THE PROPERTY OF NorComp AND SHALL NOT BE REPRODUCED, COPIED OR USED AS THE BASIS FOR THE MANUFACTURE OR SALE OF APPARATUS WITHOUT WRITTEN PERMISSION.		DRAWN: <b>C. SMITH</b>	DATE: <b>10-06-06</b>
			CHECKED:	DATE:
<b>NorComp</b>	SCALE: <b>1.5 = 1</b>	SHEET <b>2</b>	OF <b>2</b>	REV <b>3</b>
	DWG NO. <b>6848W8103L461</b>			