

Aug.1.2018 Copyright 2018 HIROSE ELECTRIC CO., LTD. All Rights Reserved.
 In case that the application demands a high level of reliability, such as automotive,
 please contact a company representative for further information.

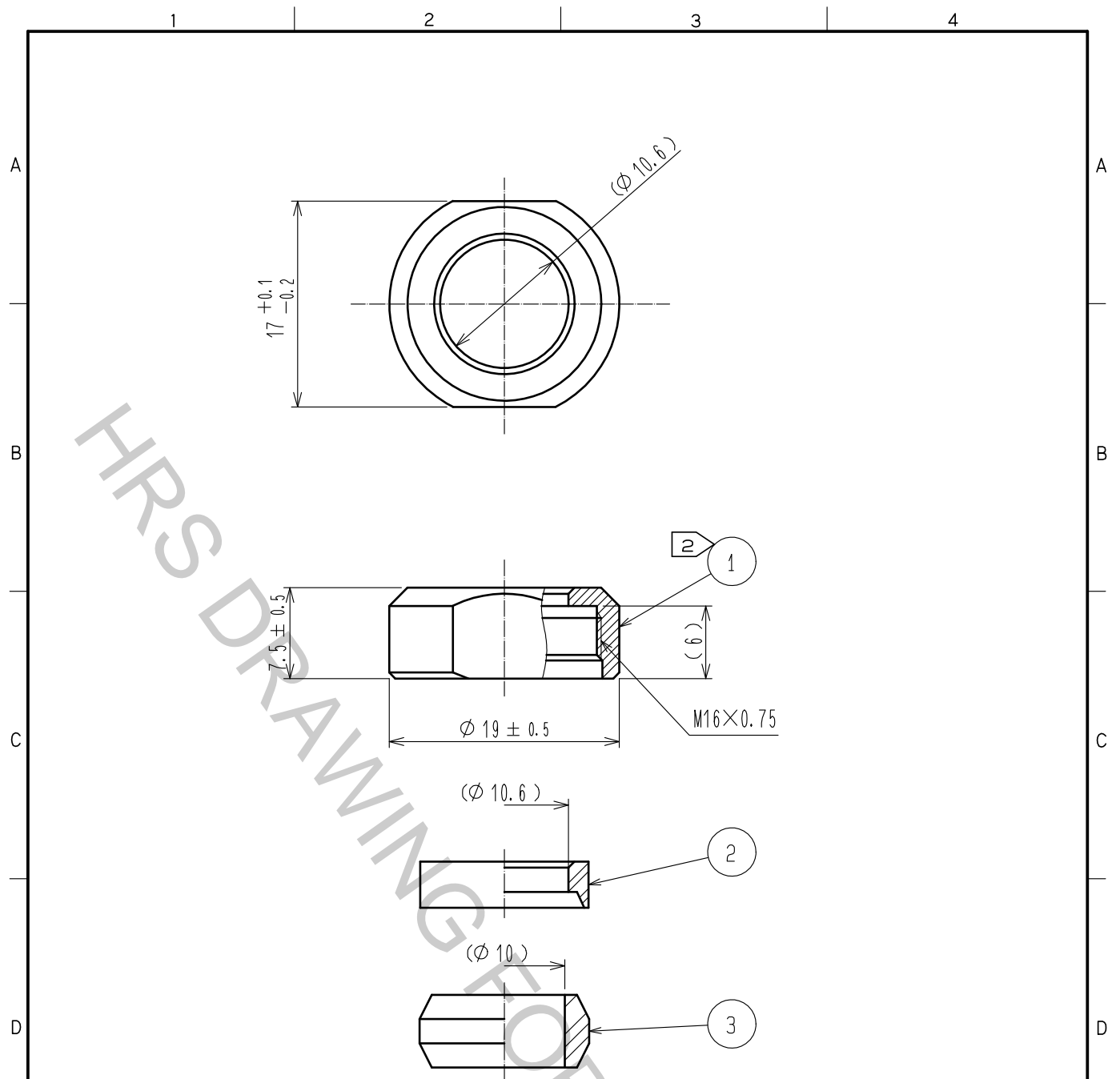

- Notes
- 1 This product is delivered disassembled.
 - 2 The recommended clamp torque of Ref.No. ① to be 2 to 2.5N · m.
 LOCTITE 263, Henkel Japan or equivalent is recommended to prevent
 Ref.No. ① from loosening.
 - 3 The cable pull and twisting strength and other characteristics may differ,
 depending on the cable structure. please before the use.

2	POLYPHENYLENE SULFIDE (BLACK)	UL94V-0						
1	BRASS	BLACK CROME PLATING	3	ACRYLONITRILE BUTADIENE RUBBER (GRAY)				
NO.	MATERIAL	FINISH .	REMARKS	NO.	MATERIAL	FINISH .	REMARKS	
UNITS mm		SCALE 2 : 1	COUNT 	DESCRIPTION OF REVISIONS		DESIGNED	CHECKED	DATE
HIROSE ELECTRIC CO., LTD.		APPROVED	·HY. KOBAYASHI	18. 02. 26	DRAWING NO.	EDC-110459-31-00		
		CHECKED	·HY. KOBAYASHI	18. 02. 26	PART NO.	JR13WCCA-10(31)		
		DESIGNED	·TH. KAMEYA	18. 02. 24	CODE NO.	CL114-2075-1-31		
		DRAWN	·MK. INOUE	18. 02. 14		1/1		