

TOLERANCE UNLESS OTHERWISE SPECIFIED	
.X	±0.25
.XX	±0.13
.XXX	±0.10

THIS IS A C.A.D. GENERATED DRAWING
DO NOT MAKE MANUAL REVISIONS TO MASTER.

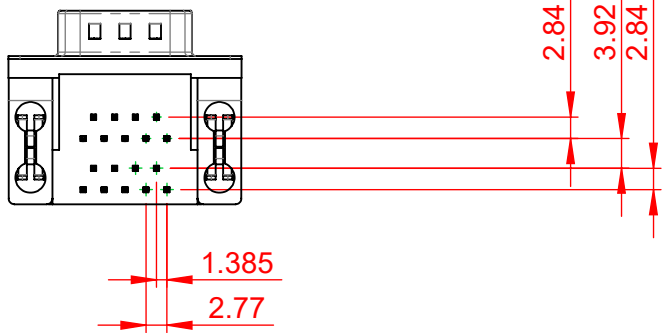

ISSUE NUMBER	
ORIGINAL	①

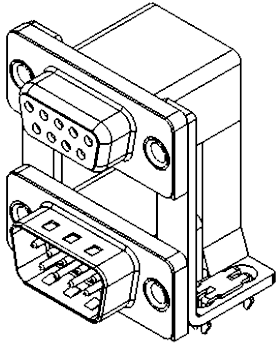
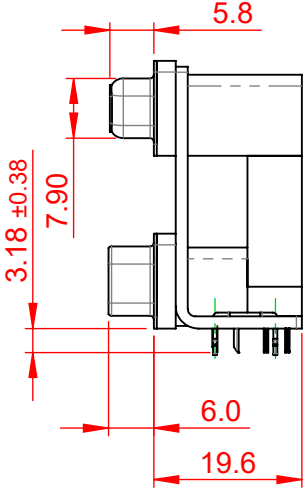

NOTES:

- MATERIAL:**
- HOUSING:** THERMOPLASTIC POLYESTER, UL94V-0, BLACK IN COLOUR
- SHELL:** STEEL, NICKEL PLATED
- CONTACT:** COPPER ALLOY, GOLD FLASH PLATING

OPERATING TEMPERATURE: -55°C ~ 85°C

- CURRENT RATING:** 3A PER CONTACT
- CONTACT RESISTANCE:** 25mΩ MAX.
- INSULATOR RESISTANCE:** 5000MΩ min.
- DIELECTRIC WITHSTANDING VOLTAGE:** 1000V AC rms

664 SERIES D-SUB CONNECTOR		SW REFERENCE NO.: 664 ASSEMBLY	
		DRAWN: C.B	DATE: AUG. 01/2018
EDAC INC TORONTO, ONTARIO CANADA YOUR CONNECTION TO QUALITY & SERVICE		CHECKED:	DATE:
		SCALE: (IN C.A.D. 1:1)	SHEET 1 OF 1
THESE DRAWINGS AND SPECIFICATIONS ARE THE PROPERTY OF EDAC INC., AND SHALL NOT BE REPRODUCED, OR COPIED OR USED AS THE BASIS FOR THE MANUFACTURE OR SALE OF APPARATUS WITHOUT WRITTEN PERMISSION.			DRAWING NUMBER: 664-009-264-030
			PART NUMBER: 664-009-264-030
			ISSUE 1

