

### FEATURES

- Wide input voltage range: 2.85 V to 15 V
- Adjustable negative output to  $V_{IN} - 39$  V
- Integrated 800 mA main switch
- 1.2 MHz/2.4 MHz switching frequency with optional external frequency synchronization from 1.0 MHz to 2.6 MHz
- Resistor programmable soft start timer
- Slew rate control for lower system noise
- Precision enable control
- UVLO, OCP, OVP, and TSD protection
- 1.61 mm × 2.18 mm, 12-ball WLCSP
- −40°C to +125°C junction temperature range
- Supported by the [ADIsimPower](#) tool set

### APPLICATIONS

- Bipolar amplifiers, analog-to-digital converters (ADCs), digital-to-analog converters (DACs), and multiplexers
- Charge coupled device (CCD) bias supplies
- Optical module supplies
- Radio frequency (RF) power amplifier (PA) bias

### GENERAL DESCRIPTION

The [ADP5075](#) is a high performance dc-to-dc inverting regulator used to generate negative supply rails.

The input voltage range of 2.85 V to 15 V supports a wide variety of applications. The integrated main switch enables the generation of an adjustable negative output voltage down to 39 V below the input voltage.

The [ADP5075](#) operates at a pin selected 1.2 MHz/2.4 MHz switching frequency. The [ADP5075](#) can synchronize with an external oscillator from 1.0 MHz to 2.6 MHz to ease noise filtering in sensitive applications. The regulator implements programmable slew rate control circuitry for the MOSFET driver stage to reduce electromagnetic interference (EMI).

The [ADP5075](#) includes a fixed internal or resistor programmable soft start timer to prevent inrush current at power-up. During shutdown, the regulator completely disconnects the load from the input supply to provide a true shutdown.

### TYPICAL APPLICATION CIRCUIT

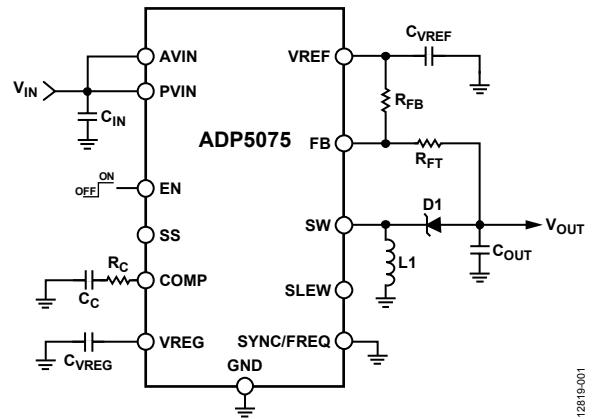

Figure 1.

12819-001

Other key safety features in the [ADP5075](#) include overcurrent protection (OCP), overvoltage protection (OVP), thermal shutdown (TSD), and input undervoltage lockout (UVLO).

The [ADP5075](#) is available in a 12-ball WLCSP and is rated for a −40°C to +125°C junction temperature range.

Table 1. Related Devices

Device	Boost Switch (A)	Inverter Switch (A)	Package
<a href="#">ADP5070</a>	1.0	0.6	20-lead LFCSP (4 mm × 4 mm) and 20-lead TSSOP
<a href="#">ADP5071</a>	2.0	1.2	20-lead LFCSP (4 mm × 4 mm) and 20-lead TSSOP
<a href="#">ADP5075</a>	Not applicable	0.8	12-ball WLCSP (1.61 mm × 2.18 mm)

## TABLE OF CONTENTS

Features .....	1	Internal Regulators .....	11
Applications .....	1	Precision Enabling .....	11
Typical Application Circuit .....	1	Soft Start .....	12
General Description .....	1	Slew Rate Control .....	12
Revision History .....	2	Current-Limit Protection .....	12
Specifications .....	3	Overvoltage Protection .....	12
Absolute Maximum Ratings .....	5	Thermal Shutdown .....	12
Thermal Resistance .....	5	Applications Information .....	13
ESD Caution .....	5	ADIsimPower Design Tool .....	13
Pin Configuration and Function Descriptions .....	6	Component Selection .....	13
Typical Performance Characteristics .....	7	Common Applications .....	16
Theory of Operation .....	11	Layout Considerations .....	18
PWM Mode .....	11	Outline Dimensions .....	19
PSM Mode .....	11	Ordering Guide .....	19
Undervoltage Lockout (UVLO) .....	11		
Oscillator and Synchronization .....	11		

## REVISION HISTORY

### 9/2017—Rev. A to Rev. B

Changes to Table 9 .....	17
--------------------------	----

### 8/2015—Rev. 0 to Rev. A

Changes to General Description Section and Figure 1 .....	1
Change to Figure 23 .....	11

### 7/2015—Revision 0: Initial Version

## SPECIFICATIONS

PVIN = AVIN = 2.85 V to 15 V, V<sub>NEG</sub> = -15 V, f<sub>SW</sub> = 1200 kHz, T<sub>J</sub> = -40°C to +125°C for minimum/maximum specifications, and T<sub>A</sub> = 25°C for typical specifications, unless otherwise noted.

Table 2.

Parameter	Symbol	Min	Typ	Max	Unit	Test Conditions/Comments
INPUT SUPPLY VOLTAGE RANGE	V <sub>IN</sub>	2.85		15	V	PVIN, AVIN
QUIESCENT CURRENT						
Operating Quiescent Current PVIN, AVIN (Total)	I <sub>Q</sub>		1.8	4.0	mA	No switching, EN = high, PVIN = AVIN = 5 V
Shutdown Current	I <sub>SHDN</sub>		5	10	μA	No switching, EN = low, PVIN = AVIN = 5 V
UVLO						AVIN
System UVLO Threshold						
Rising	V <sub>UVLO_RISING</sub>		2.8	2.85	V	
Falling	V <sub>UVLO_FALLING</sub>	2.5	2.55		V	
Hysteresis	V <sub>HYS</sub>		0.25		V	
OSCILLATOR CIRCUIT						
Switching Frequency	f <sub>SW</sub>	1.130	1.200	1.270	MHz	SYNC/FREQ = low
		2.240	2.400	2.560	MHz	SYNC/FREQ = high (connect to VREG)
SYNC/FREQ Input						
Input Clock Range	f <sub>SYNC</sub>	1.000		2.600	MHz	
Input Clock Minimum On Pulse Width	t <sub>SYNC_MIN_ON</sub>	100			ns	
Input Clock Minimum Off Pulse Width	t <sub>SYNC_MIN_OFF</sub>	100			ns	
Input Clock High Logic	V <sub>H (SYNC)</sub>			1.3	V	
Input Clock Low Logic	V <sub>L (SYNC)</sub>	0.4			V	
PRECISION ENABLING (EN)						
High Level Threshold	V <sub>TH_H</sub>	1.125	1.15	1.175	V	
Low Level Threshold	V <sub>TH_L</sub>	1.025	1.05	1.075	V	
Shutdown Mode	V <sub>TH_S</sub>	0.4			V	Internal circuitry disabled to achieve I <sub>SHDN</sub>
Pull-Down Resistance	R <sub>EN</sub>		1.48		MΩ	
INTERNAL REGULATOR						
VREG Output Voltage	V <sub>REG</sub>		4.25		V	
INVERTING REGULATOR						
Reference Voltage	V <sub>REF</sub>		1.60		V	
Accuracy		-0.5		+0.5	%	T <sub>J</sub> = 25°C
		-1.5		+1.5	%	T <sub>J</sub> = -40°C to +125°C
Feedback Voltage	V <sub>REF</sub> - V <sub>FB</sub>		0.8		V	
Accuracy		-0.5		+0.5	%	T <sub>J</sub> = 25°C
		-1.5		+1.5	%	T <sub>J</sub> = -40°C to +125°C
Feedback Bias Current	I <sub>FB</sub>			0.1	μA	
Overvoltage Protection Threshold	V <sub>OV</sub>		0.74		V	At the FB pin after soft start is complete
Load Regulation	Δ(V <sub>REF</sub> - V <sub>FB</sub> )/ I <sub>LOAD</sub>		0.0004		%/mA	I <sub>LOAD</sub> = 5 mA to 75 mA
Line Regulation	Δ(V <sub>REF</sub> - V <sub>FB</sub> )/ V <sub>PVIN</sub>		0.003		%/V	V <sub>PVIN</sub> = 2.85 V to 14.5 V, I <sub>LOAD</sub> = 15 mA
EA Transconductance	g <sub>M</sub>	270	300	330	μA/V	
Power FET On Resistance	R <sub>DS (ON)</sub>		330		mΩ	
Power FET Maximum Drain Source Voltage	V <sub>DS (MAX)</sub>		39		V	
Current-Limit Threshold	I <sub>LIM</sub>	800	880	960	mA	
Minimum On Time			60		ns	
Minimum Off Time			50		ns	

Parameter	Symbol	Min	Typ	Max	Unit	Test Conditions/Comments
SOFT START						
Soft Start Timer	t <sub>SS</sub>		4		ms	SS = open
			32		ms	SS resistor = 50 kΩ to GND
Hiccup Time	t <sub>HICCUP</sub>		8 × t <sub>SS</sub>		ms	
THERMAL SHUTDOWN						
Threshold	T <sub>SHDN</sub>		150		°C	
Hysteresis	T <sub>HYS</sub>		15		°C	

## ABSOLUTE MAXIMUM RATINGS

Table 3.

Parameter	Rating
PVIN, AVIN	-0.3 V to +18 V
SW	PVIN - 40 V to PVIN + 0.3 V
GND	-0.3 V to +0.3 V
VREG	-0.3 V to lower of AVIN + 0.3 V or +6 V
EN, FB, SYNC/FREQ	-0.3 V to +6 V
COMP, SLEW, SS, VREF	-0.3 V to VREG + 0.3 V
Operating Junction Temperature Range	-40°C to +125°C
Storage Temperature Range	-65°C to +150°C
Soldering Conditions	JEDEC J-STD-020

Stresses at or above those listed under Absolute Maximum Ratings may cause permanent damage to the product. This is a stress rating only; functional operation of the product at these or any other conditions above those indicated in the operational section of this specification is not implied. Operation beyond the maximum operating conditions for extended periods may affect product reliability.

## THERMAL RESISTANCE

$\theta_{JA}$  is based on a 4-layer printed circuit board (PCB) (two signals and two power planes) as recommended in the Layout Considerations section.  $\theta_{JC}$  is measured at the top of the package and is independent of the PCB.

Table 4. Thermal Resistance

Package Type	$\theta_{JA}$	$\theta_{JC}$	Unit
12-Ball WLCSP	68.3	1.2	°C/W

## ESD CAUTION



**ESD (electrostatic discharge) sensitive device.** Charged devices and circuit boards can discharge without detection. Although this product features patented or proprietary protection circuitry, damage may occur on devices subjected to high energy ESD. Therefore, proper ESD precautions should be taken to avoid performance degradation or loss of functionality.

## PIN CONFIGURATION AND FUNCTION DESCRIPTIONS

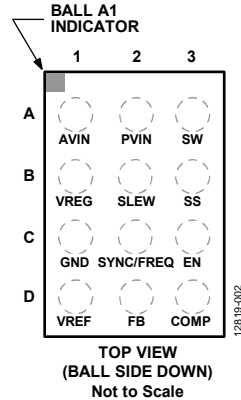

Figure 2. Pin Configuration

Table 5. Pin Function Descriptions

Pin No.	Mnemonic	Description
A1	AVIN	System Power Supply for the <a href="#">ADP5075</a> .
A2	PVIN	Power Input for the Inverting Regulator.
A3	SW	Switching Node for the Inverting Regulator.
B1	VREG	Internal Regulator Output. Connect a 1.0 $\mu\text{F}$ ceramic filter capacitor between the VREG pin and GND.
B2	SLEW	Driver Stage Slew Rate Control. The SLEW pin sets the slew rate for the FET driving the SW pin. For the fastest slew rate (best efficiency), leave the SLEW pin open. For a normal slew rate, connect the SLEW pin to VREG. For the slowest slew rate (best noise performance), connect the SLEW pin to ground.
B3	SS	Soft Start Programming. Leave the SS pin open to obtain the fastest soft start time. To program a slower soft start time, connect a resistor between the SS pin and GND.
C1	GND	Ground.
C2	SYNC/FREQ	Frequency Setting and Synchronization Input. To set the switching frequency to 2.4 MHz, pull the SYNC/FREQ pin high. To set the switching frequency to 1.2 MHz, pull the SYNC/FREQ pin low. To synchronize the switching frequency, connect the SYNC/FREQ pin to an external clock.
C3	EN	Inverting Regulator Precision Enable. The EN pin is compared to an internal precision reference to enable the inverting regulator output.
D1	VREF	Inverting Regulator Reference Output. Connect a 1.0 $\mu\text{F}$ ceramic filter capacitor between the VREF pin and ground.
D2	FB	Feedback Input for the Inverting Regulator. Connect a resistor divider between the negative side of the inverting regulator output capacitor and VREF to program the output voltage.
D3	COMP	Error Amplifier Compensation for the Inverting Regulator. Connect the compensation network between this pin and GND.

# TYPICAL PERFORMANCE CHARACTERISTICS

Typical performance characteristics are generated using the standard bill of materials for each input/output combination listed in Table 9.

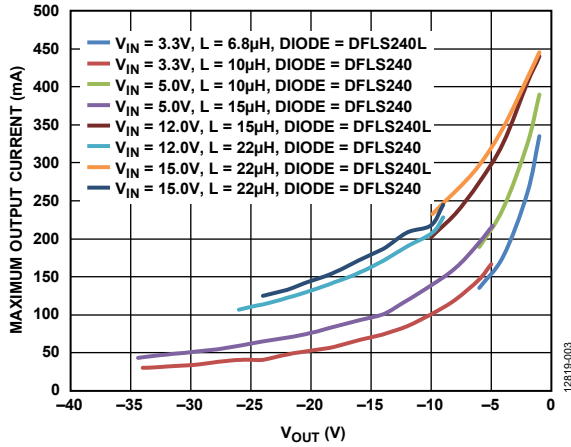

Figure 3. Maximum Output Current,  $f_{SW} = 1.2\text{ MHz}$ ,  $T_A = 25^\circ\text{C}$ , Based on Target of 70%  $I_{LIM}$

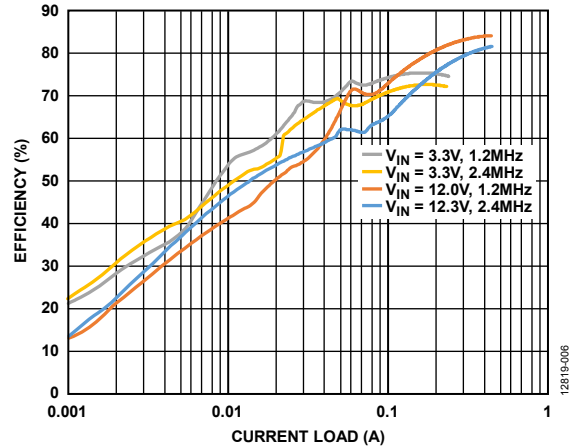

Figure 6. Efficiency vs. Current Load,  $V_{NEG} = -5\text{ V}$ ,  $T_A = 25^\circ\text{C}$

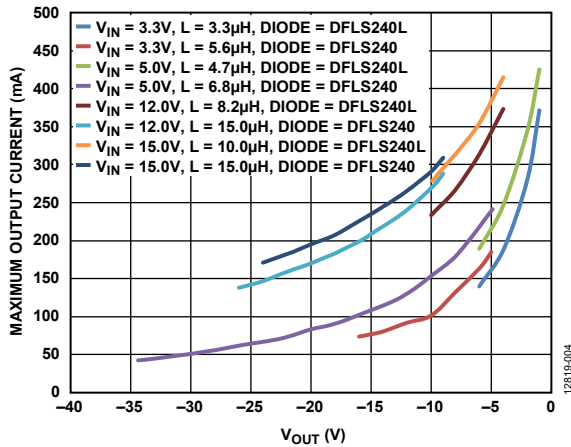

Figure 4. Maximum Output Current,  $f_{SW} = 2.4\text{ MHz}$ ,  $T_A = 25^\circ\text{C}$ , Based on Target of 70%  $I_{LIM}$

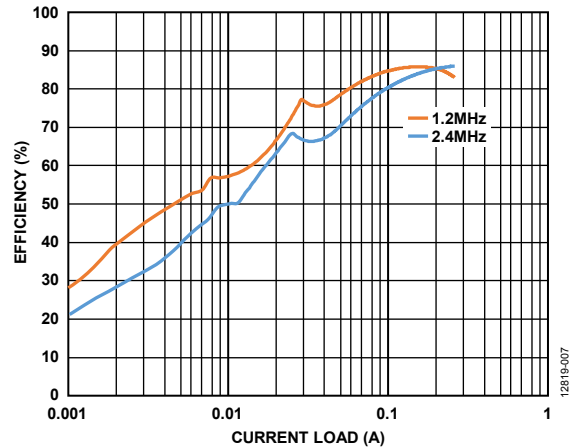

Figure 7. Efficiency vs. Current Load,  $V_{IN} = 12\text{ V}$ ,  $V_{NEG} = -15\text{ V}$ ,  $T_A = 25^\circ\text{C}$

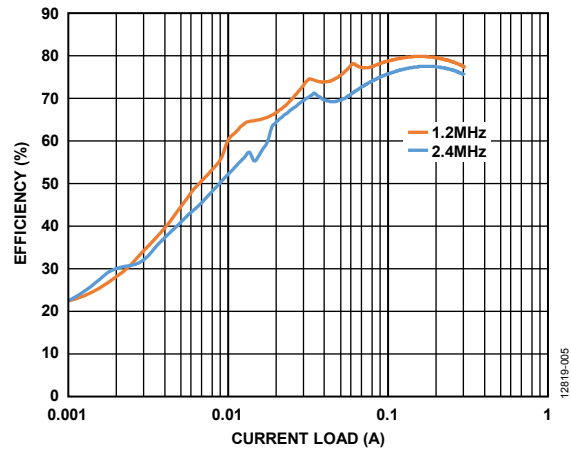

Figure 5. Efficiency vs. Current Load,  $V_{IN} = 3.3\text{ V}$ ,  $V_{NEG} = -3.3\text{ V}$ ,  $T_A = 25^\circ\text{C}$

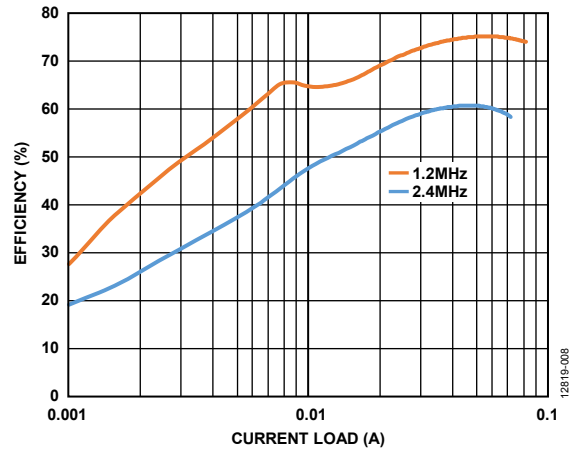

Figure 8. Efficiency vs. Current Load,  $V_{IN} = 5\text{ V}$ ,  $V_{NEG} = -30\text{ V}$ ,  $T_A = 25^\circ\text{C}$

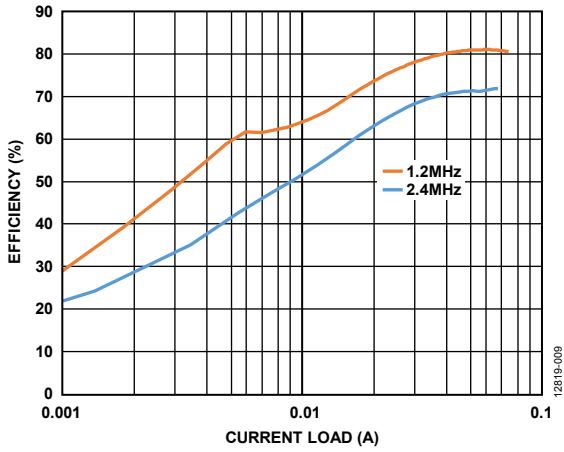

Figure 9. Efficiency vs. Current Load,  $V_{IN} = 5V$ ,  $V_{NEG} = -34V$ ,  $T_A = 25^\circ C$

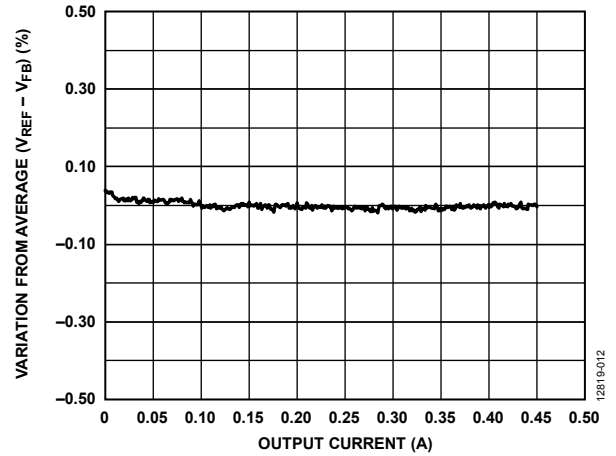

Figure 12. Load Regulation,  $V_{IN} = 12V$ ,  $V_{NEG} = -5V$ ,  $f_{SW} = 1.2MHz$ ,  $T_A = 25^\circ C$

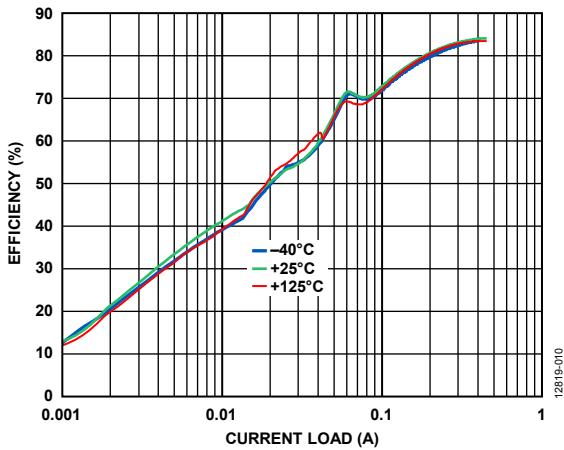

Figure 10. Efficiency vs. Current Load for Various Temperatures,  $V_{IN} = 5V$ ,  $V_{NEG} = -15V$ ,  $f_{SW} = 1.2MHz$

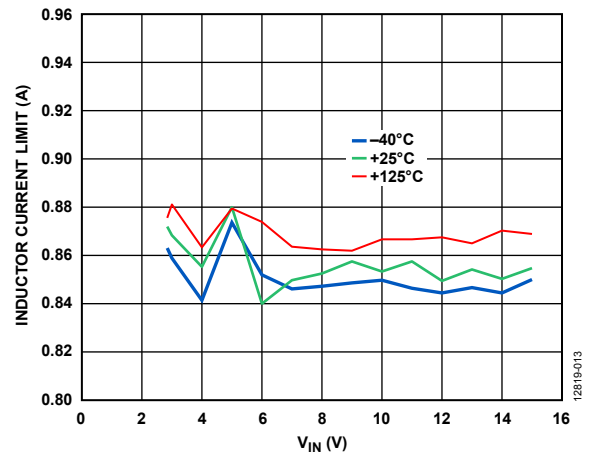

Figure 13. Inductor Current Limit ( $I_{LIMIT}$ ) vs. Input Voltage ( $V_{IN}$ ) for Various Temperatures

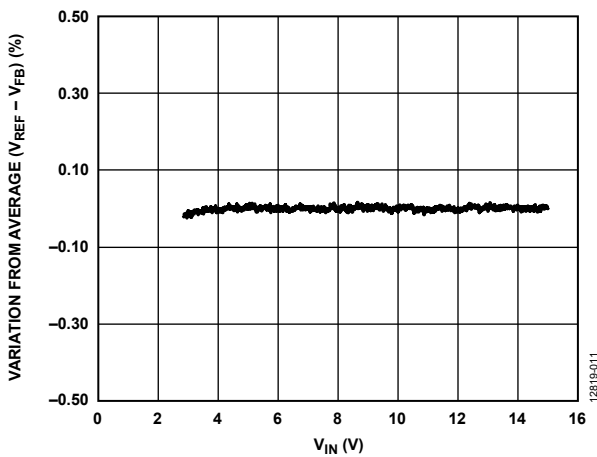

Figure 11. Line Regulation,  $V_{NEG} = -5V$ ,  $f_{SW} = 1.2MHz$ , 15 mA Load,  $T_A = 25^\circ C$

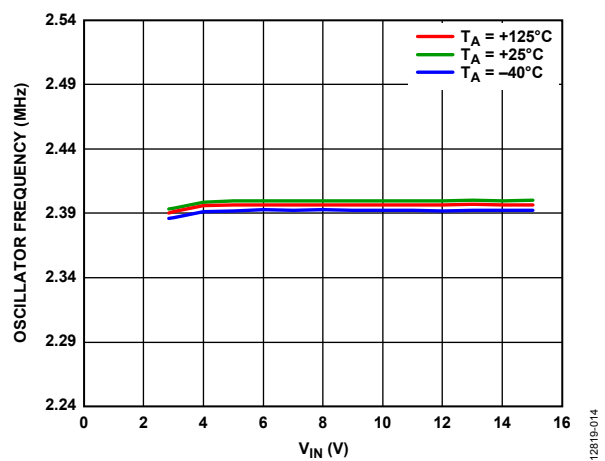

Figure 14. Oscillator Frequency vs. Input Voltage ( $V_{IN}$ ) for Various Temperatures, SYNC/FREQ Pin = High



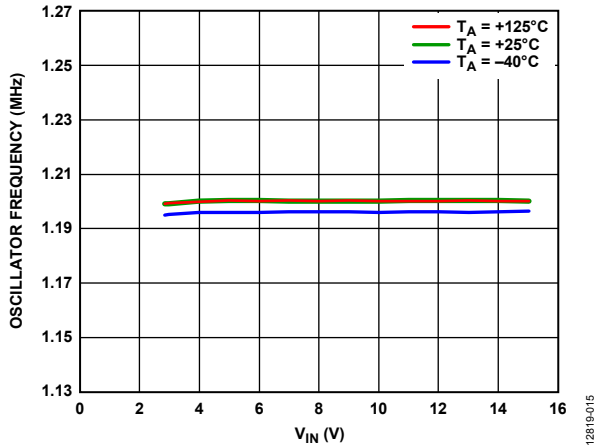

Figure 15. Oscillator Frequency vs. Input Voltage ( $V_{IN}$ ) for Various Temperatures, SYNC/FREQ Pin = Low

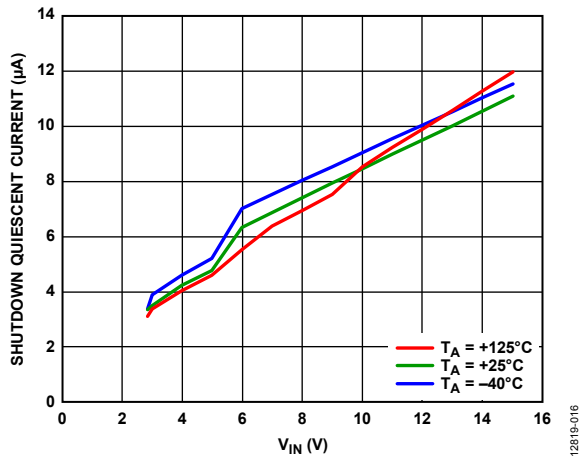

Figure 16. Shutdown Quiescent Current vs. Input Voltage ( $V_{IN}$ ) for Various Temperatures, EN Pin Below Shutdown Threshold

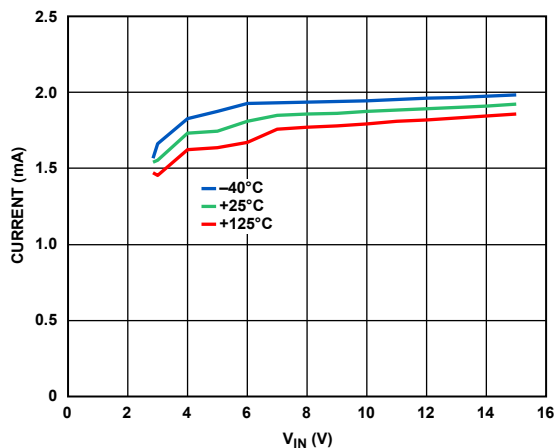

Figure 17. Operating Quiescent Current vs. Input Voltage ( $V_{IN}$ ) for Various Temperatures, EN Pin On

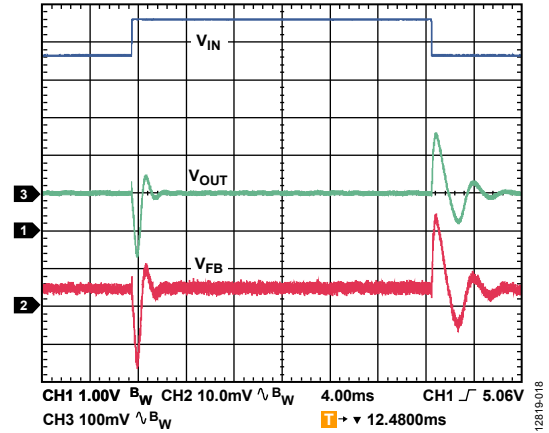

Figure 18. Line Transient Showing  $V_{IN}$ ,  $V_{OUT}$ , and  $V_{FB}$ ,  $V_{IN} = 4.5\text{ V}$  to  $5.5\text{ V}$  Step,  $V_{NEG} = -12\text{ V}$ ,  $R_{LOAD} = 300\ \Omega$ ,  $f_{SW} = 1.2\text{ MHz}$ ,  $T_A = 25^\circ\text{C}$

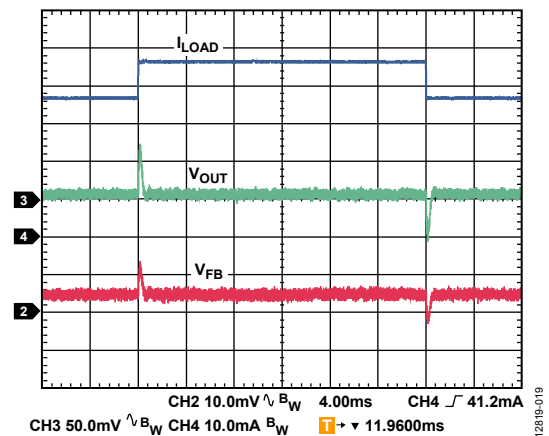

Figure 19. Load Transient Showing  $I_{LOAD}$ ,  $V_{OUT}$ , and  $V_{FB}$ ,  $V_{IN} = 5\text{ V}$ ,  $V_{NEG} = -12\text{ V}$ ,  $I_{LOAD} = 35\text{ mA}$  to  $45\text{ mA}$  Step,  $f_{SW} = 1.2\text{ MHz}$ ,  $T_A = 25^\circ\text{C}$

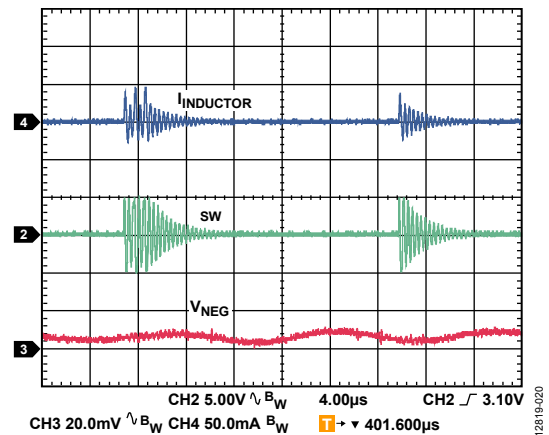

Figure 20. Skip Mode Operation Showing Inductor Current ( $I_{INDUCTOR}$ ), Switch Node Voltage, and Output Ripple,  $V_{IN} = 5\text{ V}$ ,  $V_{NEG} = -5\text{ V}$ ,  $I_{LOAD} = 0.5\text{ mA}$ ,  $f_{SW} = 1.2\text{ MHz}$ ,  $T_A = 25^\circ\text{C}$

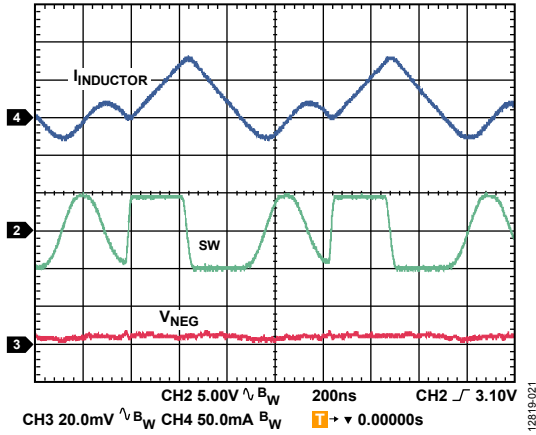

Figure 21. Discontinuous Conduction Mode Operation Showing Inductor Current ( $I_{INDUCTOR}$ ), Switch Node Voltage, and Output Ripple,  $V_{IN} = 5\text{ V}$ ,  $V_{NEG} = -5\text{ V}$ ,  $I_{LOAD} = 10\text{ mA}$ ,  $f_{SW} = 1.2\text{ MHz}$ ,  $T_A = 25^\circ\text{C}$

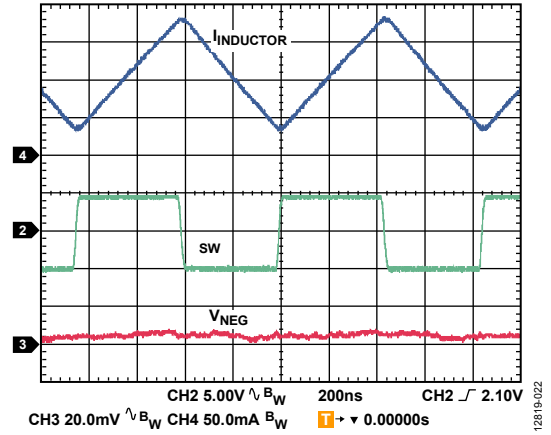

Figure 22. Continuous Conduction Mode Operation Showing Inductor Current ( $I_{INDUCTOR}$ ), Switch Node Voltage, and Output Ripple,  $V_{IN} = 5\text{ V}$ ,  $V_{NEG} = -5\text{ V}$ ,  $I_{LOAD} = 50\text{ mA}$ ,  $f_{SW} = 1.2\text{ MHz}$ ,  $T_A = 25^\circ\text{C}$



## SOFT START

The regulator in the [ADP5075](#) includes soft start circuitry that ramps the output voltage in a controlled manner during startup, thereby limiting the inrush current. The soft start time is internally set to the fastest rate when the SS pin is open.

Connecting a resistor between SS and ground allows the adjustment of the soft start delay.

## SLEW RATE CONTROL

The [ADP5075](#) uses programmable output driver slew rate control circuitry. This circuitry reduces the slew rate of the switching node as shown in Figure 24, resulting in reduced ringing and lower EMI. To program the slew rate, connect the SLEW pin to the VREG pin for normal mode, to the GND pin for slow mode, or leave it open for fast mode. This configuration allows the use of an open-drain output from a noise sensitive device to switch the slew rate from fast to slow, for example, during ADC sampling.

Note that slew rate control causes a trade-off between efficiency and low EMI.

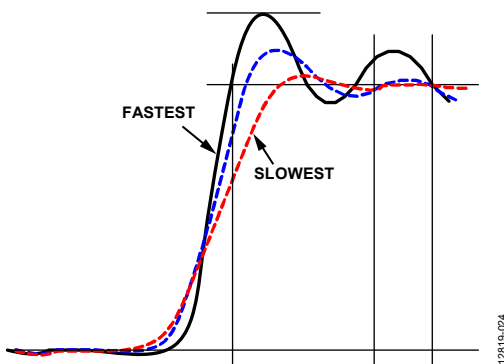

Figure 24. Switching Node at Various Slew Rate Settings

## CURRENT-LIMIT PROTECTION

The inverting regulator in the [ADP5075](#) includes current-limit protection circuitry to limit the amount of forward current through the MOSFET switch.

When the peak inductor current exceeds the overcurrent limit threshold for a number of clock cycles during an overload or short-circuit condition, the regulator enters hiccup mode. The regulator stops switching and then restarts with a new soft start cycle after  $t_{\text{HICCUP}}$  and repeats until the overcurrent condition is removed.

## OVERVOLTAGE PROTECTION

An overvoltage protection mechanism is present on the FB pin for the inverting regulator.

When the voltage on the FB pin drops below the  $V_{\text{OV}}$  threshold, the switching stops until the voltage rises above the threshold. This functionality is enabled after the soft start period has elapsed.

## THERMAL SHUTDOWN

In the event that the [ADP5075](#) junction temperature rises above  $T_{\text{SHDN}}$ , the thermal shutdown circuit turns off the IC. Extreme junction temperatures can be the result of prolonged high current operation, poor circuit board design, and/or high ambient temperature. Hysteresis is included so that when thermal shutdown occurs, the [ADP5075](#) does not return to operation until the on-chip temperature drops below  $T_{\text{SHDN}}$  minus  $T_{\text{HYS}}$ . When resuming from thermal shutdown, a soft start is performed.

## APPLICATIONS INFORMATION

### ADIsimPOWER DESIGN TOOL

The ADP5075 is supported by the ADIsimPower™ design tool set. ADIsimPower is a collection of tools that produce complete power designs optimized to a specific design goal. These tools allow the user to generate a full schematic, bill of materials, and calculate performance in minutes. ADIsimPower can optimize designs for cost, area, efficiency, and device count while taking into consideration the operating conditions and limitations of the IC and all real external components. The ADIsimPower tool can be found at [www.analog.com/adisimpower](http://www.analog.com/adisimpower), and the user can request an unpopulated board through the tool.

### COMPONENT SELECTION

#### Feedback Resistors

The ADP5075 provides an adjustable output voltage. An external resistor divider sets the output voltage, where the divider output must equal the feedback reference voltage,  $V_{FB}$ . To limit the output voltage accuracy degradation due to feedback bias current, ensure that the current through the divider is at least  $10 \times I_{FB}$ .

Set the negative output for the inverting regulator by

$$V_{NEG} = V_{FB} - \frac{R_{FT}}{R_{FB}}(V_{REF} - V_{FB})$$

where:

$V_{NEG}$  is the negative output voltage.

$V_{FB}$  is the FB reference voltage.

$R_{FT}$  is the feedback resistor from  $V_{NEG}$  to FB.

$R_{FB}$  is the feedback resistor from FB to VREF.

$V_{REF}$  is the VREF pin reference voltage.

Table 7 shows recommended values for common output voltages using standard resistor values.

**Table 7. Recommended Feedback Resistor Values**

Desired Output Voltage (V)	$R_{FT}$ (M $\Omega$ )	$R_{FB}$ (k $\Omega$ )	Actual Output Voltage (V)
-1.8	0.332	102	-1.804
-3	0.475	100	-3.000
-3.3	0.523	102	-3.302
-4.2	0.715	115	-4.174
-5	1.15	158	-5.023
-9	1.62	133	-8.944
-12	1.15	71.5	-12.067
-13	2.8	162	-13.027
-15	2.32	118	-14.929
-18	2.67	113	-18.103
-20	2.94	113	-20.014
-24	3.16	102	-23.984
-30	4.12	107	-30.004
-35	5.11	115	-34.748

#### Output Capacitor

Higher output capacitor values reduce the output voltage ripple and improve load transient response. When choosing this value, it is also important to account for the loss of capacitance due to the output voltage dc bias.

Ceramic capacitors are manufactured with a variety of dielectrics, each with a different behavior over temperature and applied voltage. Capacitors must have a dielectric adequate to ensure the minimum capacitance over the necessary temperature range and dc bias conditions. X5R or X7R dielectrics with a voltage rating of 25 V or 50 V (depending on output) are recommended for best performance. Y5V and Z5U dielectrics are not recommended for use with any dc-to-dc converter because of their poor temperature and dc bias characteristics.

Calculate the worst case capacitance accounting for capacitor variation over temperature, component tolerance, and voltage using the following equation:

$$C_{EFFECTIVE} = C_{NOMINAL} \times (1 - TEMPCO) \times (1 - DCBIASCO) \times (1 - Tolerance)$$

where:

$C_{EFFECTIVE}$  is the effective capacitance at the operating voltage.

$C_{NOMINAL}$  is the nominal data sheet capacitance.

$TEMPCO$  is the worst case capacitor temperature coefficient.

$DCBIASCO$  is the dc bias derating at the output voltage.

$Tolerance$  is the worst case component tolerance.

To guarantee the performance of the device, it is imperative that the effects of dc bias, temperature, and tolerances on the behavior of the capacitors be evaluated for each application.

Capacitors with lower effective series resistance (ESR) and effective series inductance (ESL) are preferred to minimize output voltage ripple.

Note that the use of large output capacitors may require a slower soft start to prevent current limit during startup. A 10  $\mu$ F capacitor is suggested as a good balance between performance and size.

#### Input Capacitor

Higher value input capacitors help reduce the input voltage ripple and improve transient response.

To minimize supply noise, place the input capacitor as close as possible to the AVIN and PVIN pins. A low ESR capacitor is recommended.

The effective capacitance needed for stability is a minimum of 10  $\mu$ F. If the power pins are individually decoupled, it is recommended to use an effective minimum of a 5.6  $\mu$ F capacitor on the PVIN pin and a 3.3  $\mu$ F capacitor on the AVIN pin. The minimum values specified exclude dc bias, temperature, and tolerance effects that are application dependent and must be taken into consideration.

### VREG Capacitor

A 1.0  $\mu\text{F}$  ceramic capacitor ( $C_{VREG}$ ) is required between the VREG pin and GND.

### VREF Capacitor

A 1.0  $\mu\text{F}$  ceramic capacitor ( $C_{VREF}$ ) is required between the VREF pin and GND.

### Soft Start Resistor

A resistor can be connected between the SS pin and the GND pin to increase the soft start time. The soft start time can be set using this resistor between 4 ms (268 k $\Omega$ ) and 32 ms (50 k $\Omega$ ). Leaving the SS pin open selects the fastest time of 4 ms. Figure 25 shows the behavior of this operation. Calculate the soft start time using the following formula:

$$t_{SS} = 38.4 \times 10^{-3} - 1.28 \times 10^{-7} \times R_{SS} (\Omega)$$

where  $50 \text{ k}\Omega \leq R_{SS} \leq 268 \text{ k}\Omega$ .

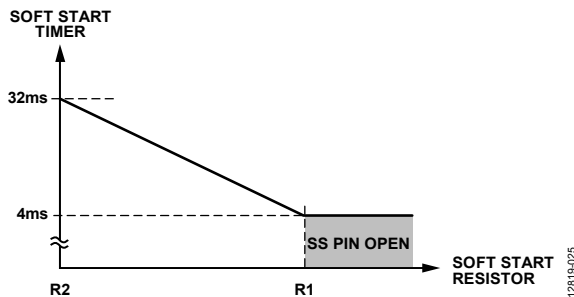

Figure 25. Soft Start Behavior

### Diodes

A Schottky diode with low junction capacitance is recommended for D1. At higher output voltages and especially at higher switching frequencies, the junction capacitance is a significant contributor to efficiency. Higher capacitance diodes also generate more switching noise. As a guide, a diode with less than 40 pF junction capacitance is preferred when the output voltage is greater than  $-5 \text{ V}$ .

### Inductor Selection

The inductor stores energy during the on time of the power switch, and transfers that energy to the output through the output rectifier during the off time. To balance the tradeoffs between small inductor current ripple and efficiency, inductance values in the range of 1  $\mu\text{H}$  to 22  $\mu\text{H}$  are recommended. In general, lower inductance values have higher saturation current and lower series resistance for a given physical size. However, lower inductance results in a higher peak current that can lead to reduced efficiency and greater input and/or output ripple and noise. A peak-to-peak inductor ripple current close to 30% of the maximum dc current in the inductor typically yields an optimal compromise.

For the smallest solution size, inductors with a saturation current below  $I_{LIM}$  may be used when the output current in the application is such that the inductor current stays below the saturated region.

For the inductor ripple current in continuous conduction mode (CCM) operation, the input ( $V_{IN}$ ) and output ( $V_{NEG}$ ) voltages determine the switch duty cycle (Duty) by the following equation:

$$Duty = \left( \frac{|V_{NEG}| + V_{DIODE}}{V_{IN} + |V_{NEG}| + V_{DIODE}} \right)$$

where  $V_{DIODE}$  is the forward voltage drop of the Schottky diode (D1).

The dc current in the inductor in CCM ( $I_{L1}$ ) can be determined using the following equation:

$$I_{L1} = \frac{I_{OUT}}{(1 - Duty)}$$

Using the duty cycle (Duty) and switching frequency ( $f_{SW}$ ), determine the on time ( $t_{ON}$ ) using the following equation:

$$t_{ON} = \frac{Duty}{f_{SW}}$$

The inductor ripple current ( $\Delta I_{L1}$ ) in steady state is calculated by

$$\Delta I_{L1} = \frac{V_{IN} \times t_{ON}}{L1}$$

Solve for the inductance value (L1) using the following equation:

$$L1 = \frac{V_{IN} \times t_{ON}}{\Delta I_{L1}}$$

Assuming an inductor ripple current of 30% of the maximum dc current in the inductor results in

$$L1 = \frac{V_{IN} \times t_{ON} \times (1 - Duty)}{0.3 \times I_{OUT}}$$

Ensure that the peak inductor current (the maximum input current plus half the inductor ripple current) is below the rated saturation current of the inductor. Likewise, ensure that the maximum rated rms current of the inductor is greater than the maximum dc input current to the regulator.

When the ADP5075 inverting regulator is operated in CCM at duty cycles greater than 50%, slope compensation is required to stabilize the current mode loop. For stable current mode operation, ensure that the selected inductance is equal to or greater than the minimum calculated inductance,  $L_{MIN}$ , for the application parameters in the following equation:

$$L1 > L_{MIN} = V_{IN} \times \left( \frac{0.27}{(1 - Duty)} - 0.33 \right) (\mu\text{H})$$

Table 9 suggests a series of inductors to use with the ADP5075 inverting regulator.

### Loop Compensation

The ADP5075 uses external components to compensate the regulator loop, allowing the optimization of the loop dynamics for a given application. It is recommended to use the ADIsimPower tool to calculate compensation components.

The inverting converter, produces an undesirable right half plane zero in the regulation feedback loop. This feedback loop requires compensating the regulator such that the crossover frequency occurs well below the frequency of the right half plane zero. The right half plane zero frequency is determined by the following equation:

$$f_z(RHP) = \frac{R_{LOAD}(1 - Duty)^2}{2\pi \times L1 \times Duty}$$

where:

$f_z(RHP)$  is the right half plane zero frequency.

$R_{LOAD}$  is the equivalent load resistance or the output voltage divided by the load current.

$$Duty = \left( \frac{|V_{NEG}| + V_{DIODE}}{V_{IN} + |V_{NEG}| + V_{DIODE}} \right)$$

where  $V_{DIODE}$  is the forward voltage drop of the Schottky diode (D1).

To stabilize the regulator, ensure that the regulator crossover frequency is less than or equal to one-tenth of the right half plane zero frequency.

The regulator loop gain is

$$A_{VL} = \frac{V_{FB}}{|V_{NEG}|} \times \frac{V_{IN}}{(V_{IN} + 2 \times |V_{NEG}|)} \times G_M \times$$

$$|R_{OUT}||Z_{COMP}| \times G_{CS} \times |Z_{OUT}|$$

where:

$A_{VL}$  is the regulator loop gain.

$V_{FB}$  is the feedback regulation voltage.

$V_{NEG}$  is the regulated negative output voltage.

$V_{IN}$  is the input voltage.

$G_M$  is the error amplifier transconductance gain.

$R_{OUT}$  is the output impedance of the error amplifier and is 33 MΩ.

$Z_{COMP}$  is the impedance of the series RC network from COMP to GND.

$G_{CS}$  is the current sense transconductance gain (the inductor current divided by the voltage at COMP), which is internally set by the ADP5075 and is 6.25 A/V.

$Z_{OUT}$  is the impedance of the load in parallel with the output capacitor.

To determine the crossover frequency, it is important to note that, at that frequency, the compensation impedance ( $Z_{COMP}$ ) is dominated by a resistor,  $R_C$ , and the output impedance ( $Z_{OUT}$ ) is dominated by the impedance of the output capacitor ( $C_{OUT}$ ).

Therefore, when solving for the crossover frequency, the equation (by definition of the crossover frequency) is simplified to

$$|A_{VL}| = \frac{V_{FB}}{|V_{NEG}|} \times \frac{V_{IN}}{(V_{IN} + 2 \times |V_{NEG}|)} \times G_M \times R_C \times G_{CS} \times \frac{1}{2\pi \times f_c \times C_{OUT}} = 1$$

where  $f_c$  is the crossover frequency.

To solve for  $R_C$ , use the following equation:

$$R_C = \frac{2\pi \times f_c \times C_{OUT} \times |V_{NEG}| \times (V_{IN} + (2 \times |V_{NEG}|))}{V_{FB} \times V_{IN} \times G_M \times G_{CS}}$$

where  $G_{CS} = 6.25$  A/V.

Using typical values for  $V_{FB}$  and  $G_M$  results in

$$R_C = \frac{4188 \times f_c \times C_{OUT} \times |V_{NEG}| \times (V_{IN} + (2 \times |V_{NEG}|))}{V_{IN}}$$

For better accuracy, it is recommended to use the value of output capacitance ( $C_{OUT}$ ) that takes into account the capacitance reduction from dc bias in the calculation for  $R_C$ .

After the compensation resistor is known, set the zero formed by  $C_C$  and  $R_C$  to one-fourth of the crossover frequency, or

$$C_C = \frac{2}{\pi \times f_c \times R_C}$$

where  $C_C$  is the compensation capacitor.

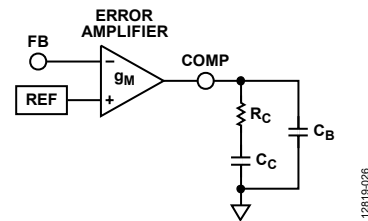

Figure 26. Compensation Components

The optional capacitor,  $C_B$ , is chosen to cancel the zero introduced by the ESR of the output capacitor. For low ESR capacitors such as ceramic chip capacitors,  $C_B$  can be omitted from the design.

Solve for  $C_B$  as follows:

$$C_B = \frac{ESR \times C_{OUT}}{R_C}$$

For optimal transient performance,  $R_C$  and  $C_C$  may need to be adjusted by observing the load transient response of the ADP5075. For most applications,  $R_C$  is within the range of 1 kΩ to 200 kΩ, and  $C_C$  is within the range of 1 nF to 68 nF.

**COMMON APPLICATIONS**

Table 8 and Table 9 list a number of common component selections for typical  $V_{IN}$  and  $V_{NEG}$  conditions. These have been bench tested and provide an off the shelf solution. To optimize components for an application, use the [ADIsimPower](#) tool set.

Figure 27 shows the schematic referenced by Table 8 and Table 9 with example component values for a +5 V input to a -15 V output. Table 8 shows the components common to all  $V_{IN}$  and  $V_{NEG}$  conditions.

**Table 8. Recommended Common Component Selections**

Reference	Value	Part Number	Manufacturer
$C_{IN}$	10 $\mu$ F	TMK316B7106KL-TD	Taiyo Yuden
$C_{VREG}$	1 $\mu$ F	GRM188R71A105KA61D	Murata
$C_{VREF}$	1 $\mu$ F	GRM188R71A105KA61D	Murata

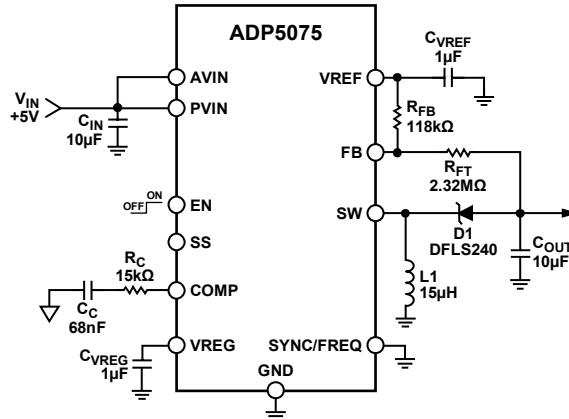

Figure 27. Typical +5 V Input to -15 V Output, 1.2 MHz Application

12918-027



Table 9. Recommended Inverting Regulator Components

V <sub>IN</sub> (V)	V <sub>NEG</sub> (V)	Freq. (MHz)	L1 ( $\mu$ H)	L1, Manufacturer Part Number		C <sub>OUT</sub> ( $\mu$ F)	C <sub>OUT2</sub> , Murata Part	D1, Diodes, Inc. Part	R <sub>FT</sub> (M $\Omega$ )	R <sub>FB</sub> (k $\Omega$ )	C <sub>C</sub> (nF)	R <sub>C</sub> (k $\Omega$ )
				Coilcraft®	Würth Elektronik							
3.3	-5	1.2	6.8	XAL4030-682ME_	7443857068	10	GRM32ER71H106KA12L	DFLS240L	1.15	158	47	4.7
3.3	-5	2.4	4.7	XAL4030-472ME_	7443857047	10	GRM32ER71H106KA12L	DFLS240L	1.15	158	47	6.8
3.3	-9	1.2	10	XAL4040-103ME_	N/A	10	GRM32ER71H106KA12L	DFLS240	1.62	133	47	8.2
3.3	-9	2.4	4.7	XAL4030-472ME_	74438357047	10	GRM32ER71H106KA12L	DFLS240	1.62	133	47	8.2
3.3	-15	1.2	10	XAL4040-103ME_	N/A	10	GRM32ER71H106KA12L	DFLS240	2.32	118	47	12
3.3	-15	2.4	4.7	XAL4030-472ME_	74438357047	10	GRM32ER71H106KA12L	DFLS240	2.32	118	47	18
3.3	-24	1.2	10	XAL4040-103ME_	N/A	10	GRM32ER71H106KA12L	DFLS240	3.16	102	47	22
3.3	-24	2.4	6.8	XAL4030-682ME_	74438357068	10	GRM32ER71H106KA12L	DFLS240	3.16	102	47	33
3.3	-34	1.2	10	XAL4040-103ME_	N/A	10	GRM32ER71H106KA12L	DFLS240	4.99	115	47	47
3.3	-34	2.4	10	XAL4040-103ME_	N/A	10	GRM32ER71H106KA12L	DFLS240	4.99	115	47	47
5	-9	1.2	10	XAL4040-103ME_	N/A	10	GRM32ER71H106KA12L	DFLS240	1.62	133	47	8.2
5	-9	2.4	6.8	XAL4030-682ME_	7448357068	10	GRM32ER71H106KA12L	DFLS240	1.62	133	47	8.2
5	-15	1.2	15	XAL4040-153ME_	N/A	10	GRM32ER71H106KA12L	DFLS240	2.32	118	68	15
5	-15	2.4	6.8	XAL4030-682ME_	7448357068	10	GRM32ER71H106KA12L	DFLS240	2.32	118	47	22
5	-24	1.2	15	XAL4040-153ME_	N/A	10	GRM32ER71H106KA12L	DFLS240	3.16	102	47	22
5	-24	2.4	6.8	XAL4030-682ME_	74438357068	10	GRM32ER71H106KA12L	DFLS240	3.16	102	47	22
5	-34	1.2	15	XAL4040-153ME_	N/A	10	GRM32ER71H106KA12L	DFLS240	4.99	115	47	39
5	-34	2.4	10	XAL4040-103ME_	N/A	10	GRM32ER71H106KA12L	DFLS240	4.99	115	47	39
12	-24	1.2	22	XAL5050-223ME_	N/A	10	GRM32ER71H106KA12L	DFLS240	3.16	102	47	10
12	-24	2.4	15	XAL4040-153ME_	N/A	10	GRM32ER71H106KA12L	DFLS240	3.16	102	47	10

## LAYOUT CONSIDERATIONS

Layout is important for all switching regulators but is particularly important for regulators with high switching frequencies. To achieve high efficiency, good regulation, good stability, and low noise, a well designed PCB layout is required. Follow these guidelines when designing PCBs:

- Keep the input bypass capacitor, CIN, close to the PVIN pin and the AVIN pin. Route each of these pins individually to the pad of this capacitor to minimize noise coupling between the power inputs, rather than connecting the three pins at the device. A separate capacitor can be used on the AVIN pin for the best noise performance.
- Keep the high current paths as short as possible. These paths include the connections between CIN, L1, D1, COUT, and GND and their connections to the ADP5075.
- Keep high current traces as short and wide as possible to minimize parasitic series inductance, which causes spiking and EMI.

- Avoid routing high impedance traces near any node connected to the SW pin or near inductor L1 to prevent radiated switching noise injection.
- Place the feedback resistors as close to the FB pin as possible to prevent high frequency switching noise injection.
- Route a trace to RFT directly from the COUT pad for optimum output voltage sensing.
- Place the compensation components as close as possible to COMP. Do not share vias to the ground plane with the feedback resistors to avoid coupling high frequency noise into the sensitive COMP pin.
- Place the CVREF and CVREG capacitors as close to the VREG and VREF pins as possible. Ensure that short traces are used between VREF and RFB.

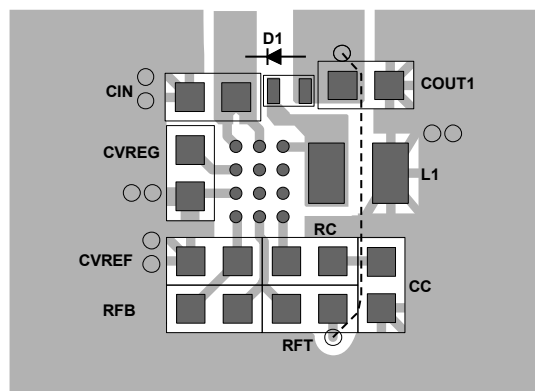

Figure 28. Suggested Layout for 5 mm × 6 mm, +3.3 V Input to -5 V Output Application  
(Dashed Line Is Connected on the Internal Layer of the PCB; Other Vias Connected to the Ground Plane;  
SS, EN, SLEW, and SYNC/FREQ Connections Not Shown for Clarity and Are Typically Connected on an Internal Layer)

OUTLINE DIMENSIONS

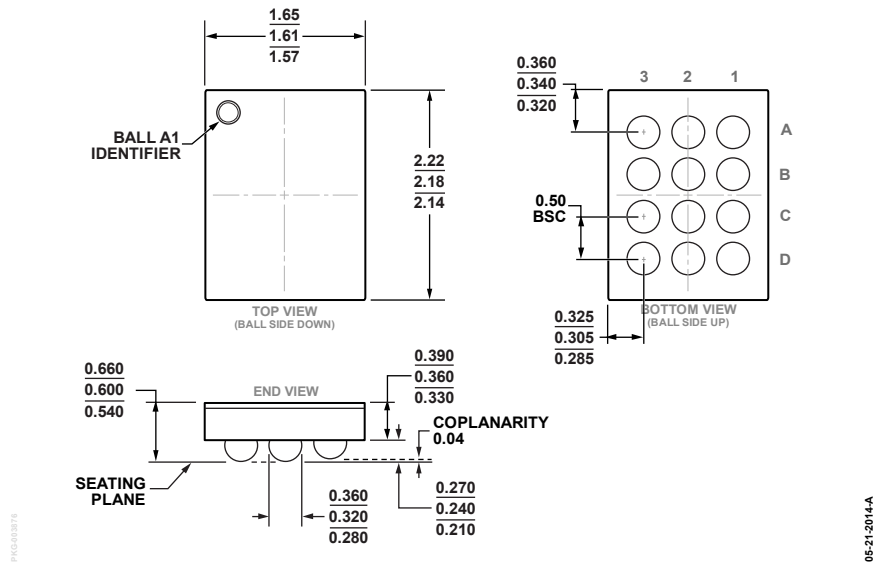

Figure 29. 12-Ball Wafer Level Chip Scale Package [WLCSP]  
(CB-12-11)  
Dimensions shown in millimeters

ORDERING GUIDE

Model <sup>1</sup>	Temperature Range	Package Description	Package Option
ADP5075ACBZ-R7	-40°C to +125°C	12-Ball Wafer Level Chip Scale Package [WLCSP]	CB-12-11
ADP5075CB-EVALZ		Evaluation Board	

<sup>1</sup> Z = RoHS Compliant Part.