



Trusted RF Solutions™

HILNA V1

Low Noise Amplifier

50 - 1000 MHz

20 dB Gain

P/N: HILNA-V1

(includes NW-LN-ACC-CB02CA interface cable)



NuWaves' HILNA V1™ is the first in its class of broadband low noise amplifiers designed to achieve high gain while maintaining low noise and a high third-order intercept point from VHF to microwave frequencies.

This high-performance module delivers 20 dB of gain across the frequency range of 50 MHz to 1000 MHz with an OIP3 of +32 dBm and less than 1 dB of noise figure.

HILNA V1's robust power supply also operates over a very broad range, easily allowing the unit to be integrated into systems without regard to power supply precision.

Features

- 50 to 1000 MHz
- Low Noise and High Gain
- Broadband Operation
- High Intercept Point
- Over-Voltage Protection
- Reverse-Voltage Protection
- Wide Input Voltage Range
- High Linearity
- Internal Regulator/Active Bias Devices for Stability

Benefits

- Low Level Signal Amplification
- Improved Link Margin
- Ruggedized Chassis for Harsh Environments

Applications

- Wideband RF Front Ends
- High Performance Receivers
- Broadband High Gain Block
- Low Noise Transmit Driver
- RF Preamplifier
- RF Repeater
- Base Station LNA
- University Research and Instruction
- Multi-Signal Environment Amplifier

HILNA V1 Low Noise Amplifier

Specifications

Absolute Maximums

Parameter	Rating	Unit
Max Device Voltage	20	V
Max Device Current	90	mA
Max RF Input Power, $Z_L = 50 \Omega$	15	dBm
Max Operating Temperature	70	°C
Max Storage Temperature	70	°C

Export Classification
EAR99

Electrical Specifications @ 12VDC, 25 °C, $Z_S=Z_L=50 \Omega$

Parameter	Symbol	Min	Typ	Max	Unit	Condition
Operating Frequency	BW	50		1000	MHz	
RF Gain	G	17	20		dB	
Reverse Isolation			27		dB	
VSWR	VSWR		1.5:1			Input
			1.5:1			Output
Noise Figure	NF	0.7	0.8		dB	
Third Order Order Intercept Point	OIP3	28	32		dBm	
Output Power @ 1dB Compression	P1dB	15	17		dBm	
Operating Voltage	VDC	+5	+12	+20	V	
Operating Current	I_{DD}		70		mA	@ 12VDC (typ)

Mechanical Specifications

Parameter	Value	Unit	Limits
Dimensions	3.15 x 3.92 x 1.18	in	Max
Weight	5.7	oz	Max
RF Connectors, Input/Output	SMA Female		
DC Power Connector	2 mm Circular		

Environmental Specifications

Parameter	Symbol	Min	Typ	Max	Unit
Operating Temperature	T_C	-30		+70	°C
Storage Temperature	T_{STG}	-40		+85	°C
Relative Humidity (non-condensing)	RH			95	%
Altitude MIL-STD-810F - Method 500.4	ALT			30,000	ft
Vibration / Shock Profile (Random profile in x,y, z axis, as per Figure for 15 minute duration in each axis)					

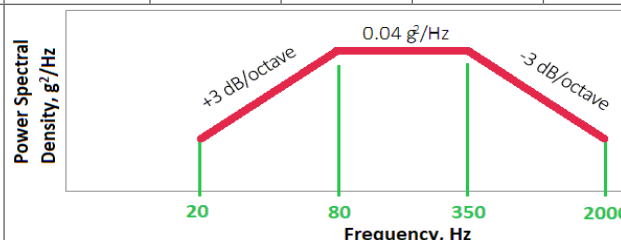

HILNA V1 Low Noise Amplifier

Performance Plots

Gain (S21)

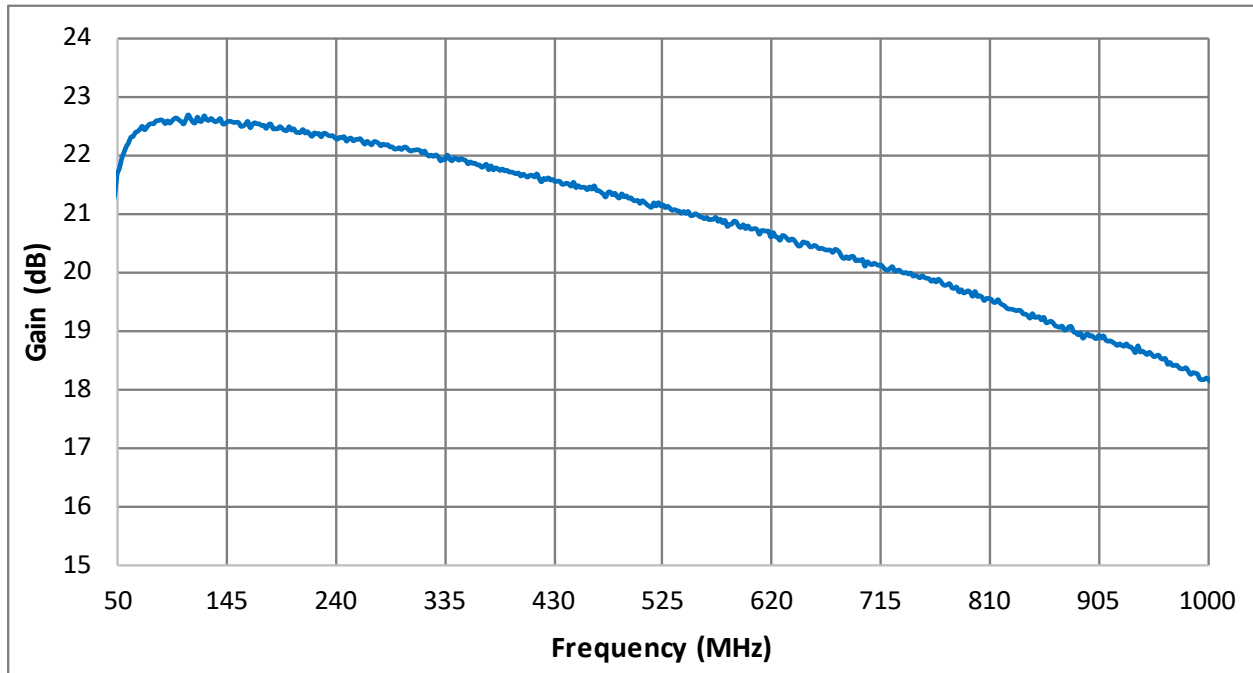

Noise Figure

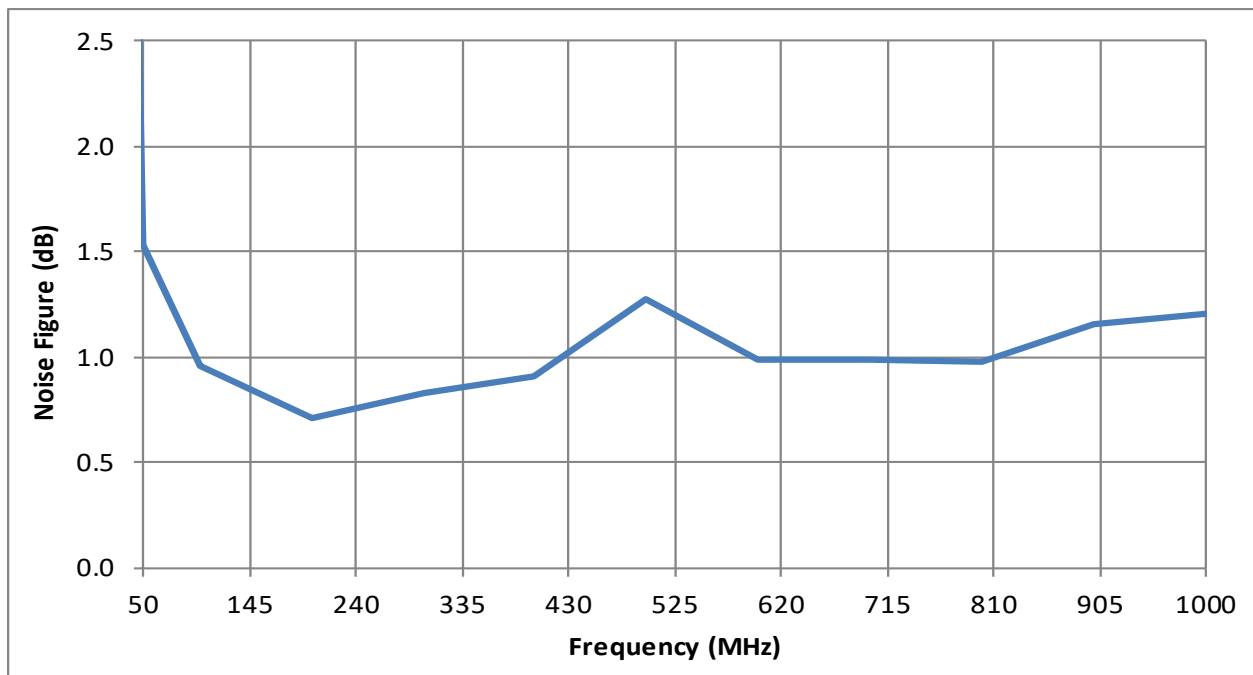

HILNA V1 Low Noise Amplifier

Performance Plots (cont.)

Output Power @ 1 dB Compression

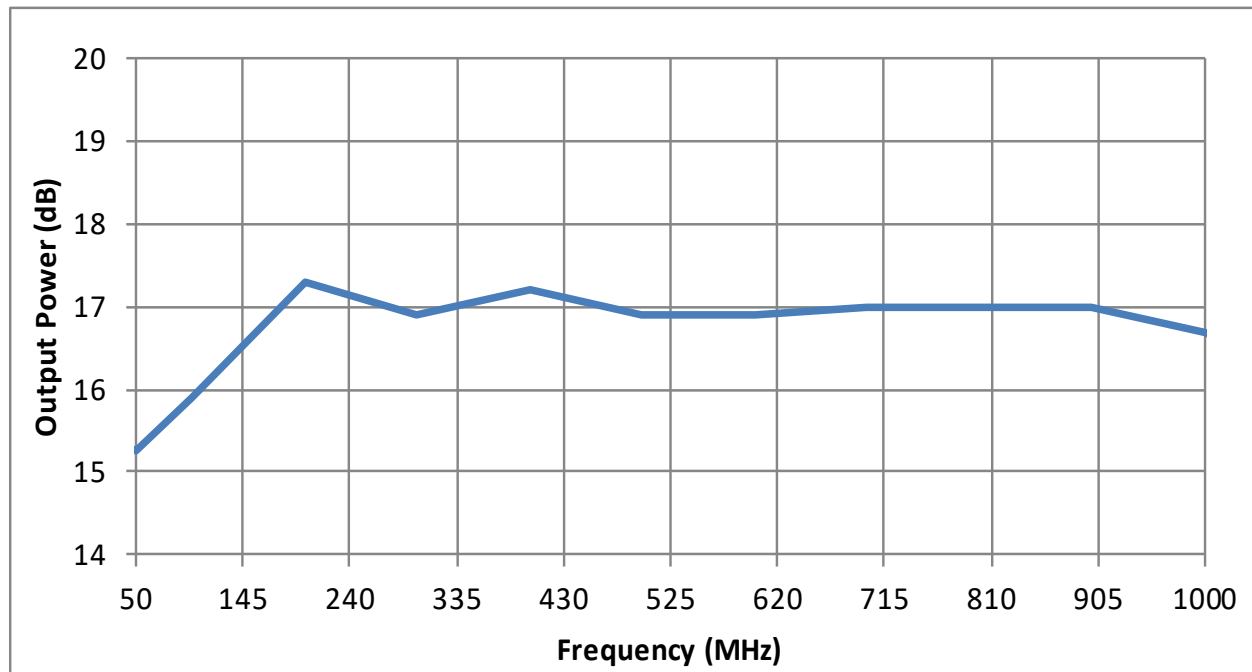

Power Compression

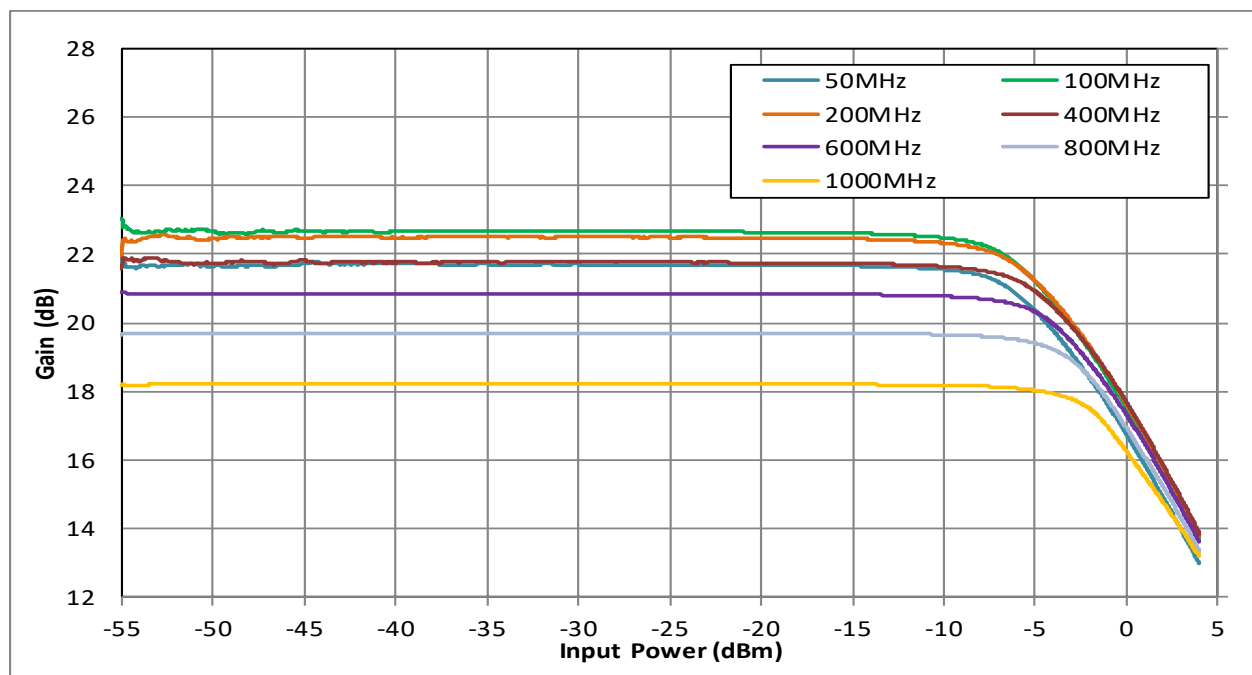

HILNA V1 Low Noise Amplifier

Performance Plots (cont.)

OIP3 vs. Frequency

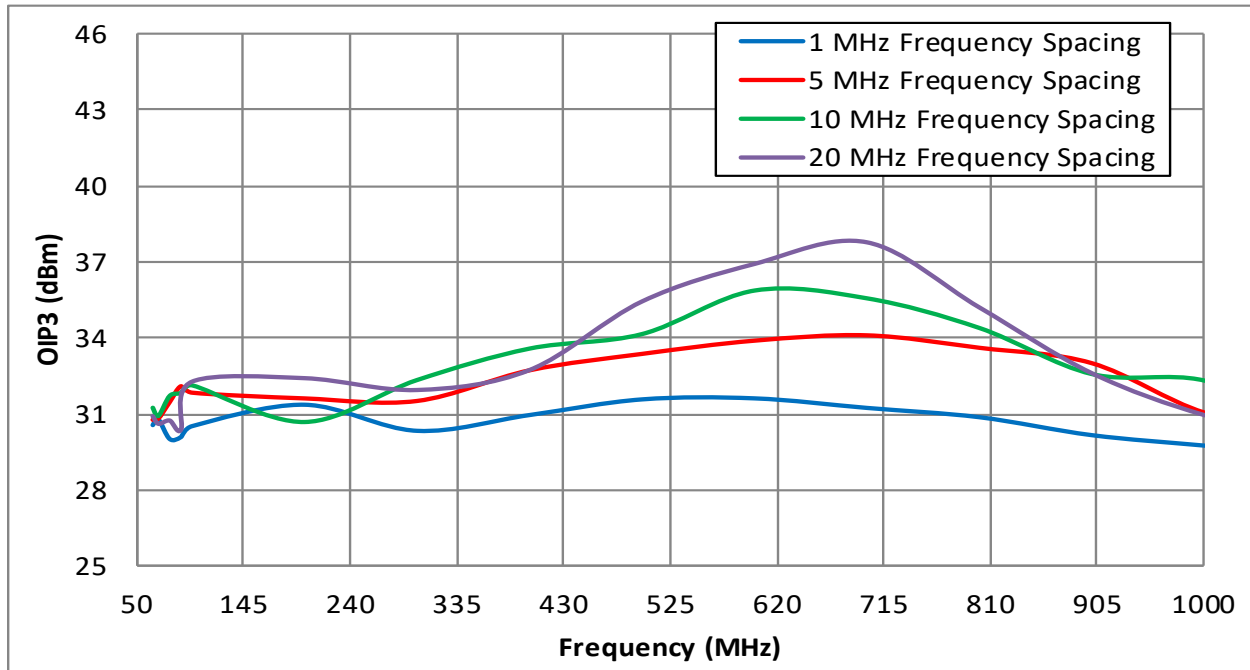

Reverse Isolation

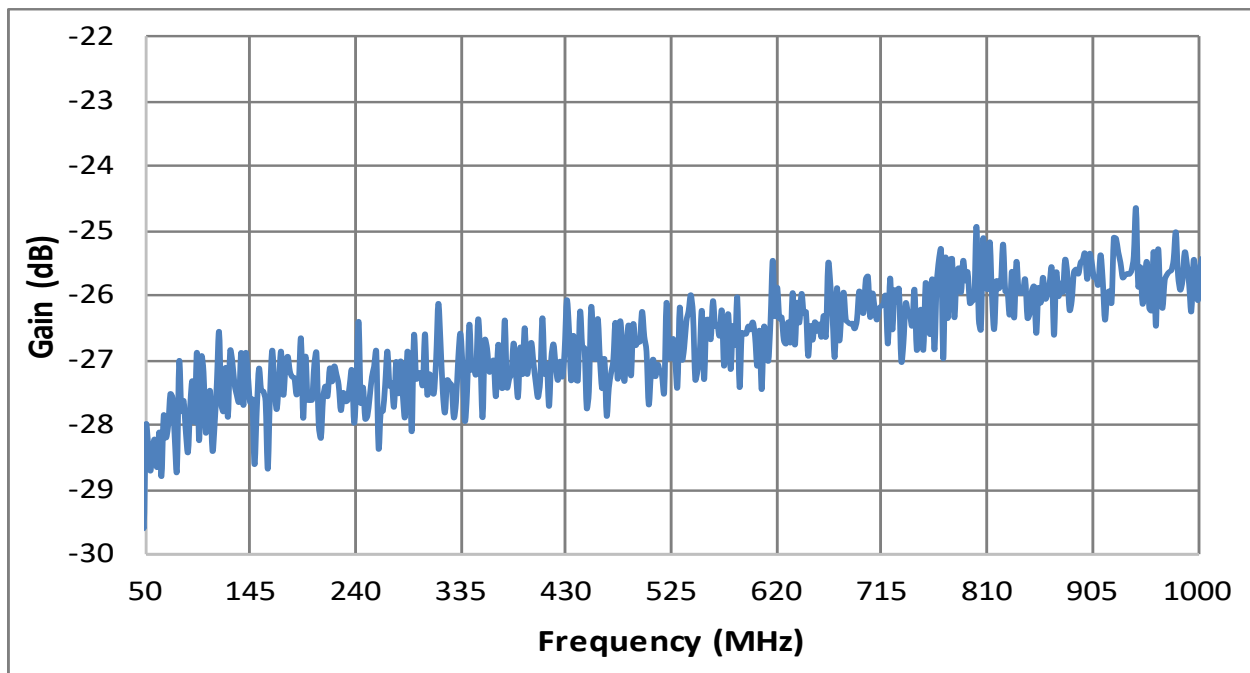

HILNA V1 Low Noise Amplifier

Performance Plots (cont.)

Input and Output VSWR

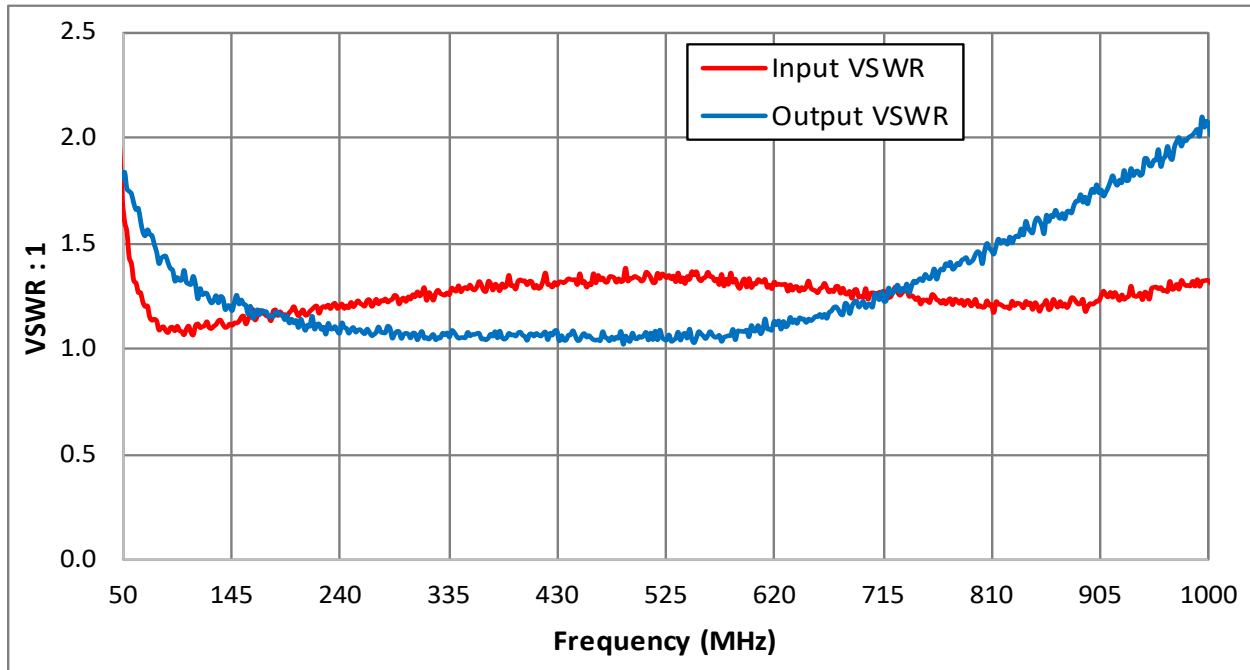

Gain vs Temperature

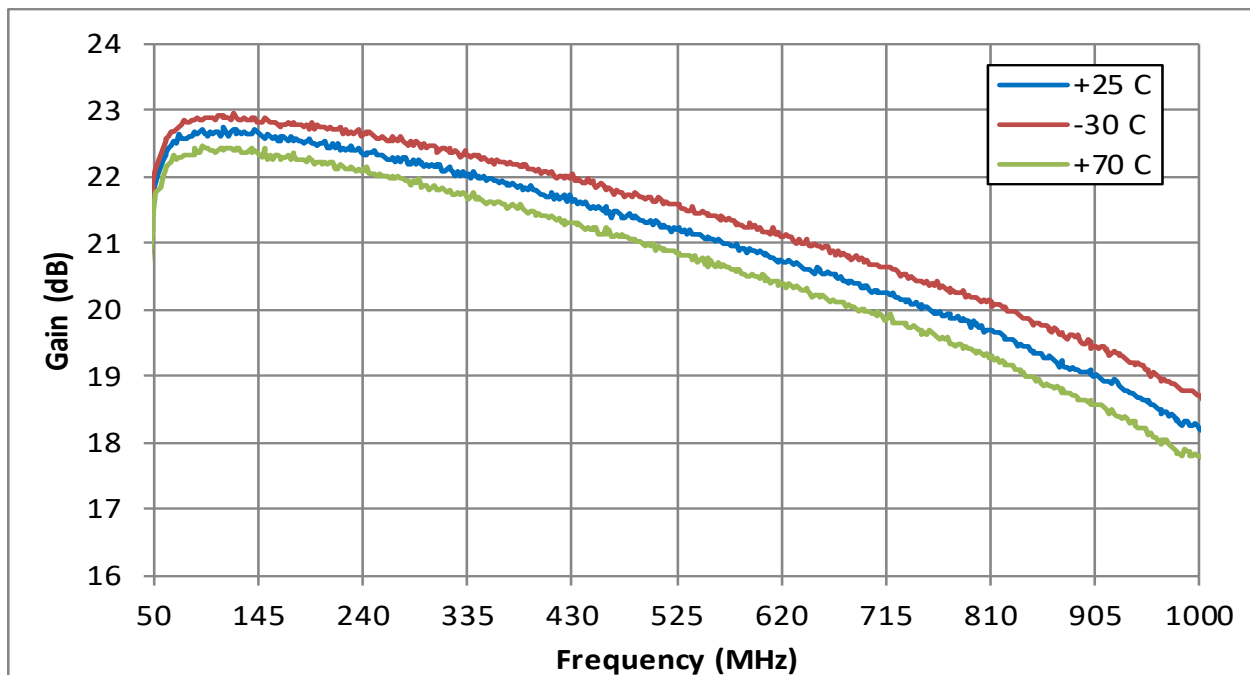

HILNA V1 Low Noise Amplifier

Mechanical Outline

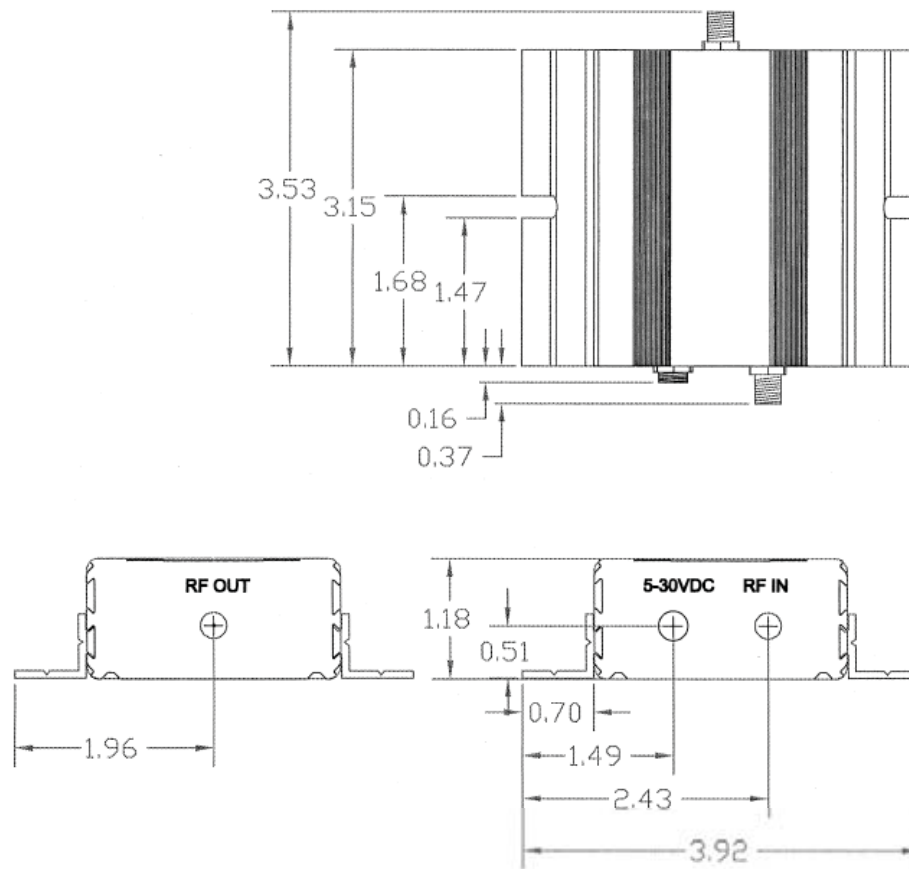

Accessory Part Numbers

Part Number	Description
NW-LN-ACC-CB02CA	Standard Interface Cable Assembly - Flying Leads (included w/ module)
NW-LN-ACC-CT02CA	Upgraded Interface Cable Assembly - Banana Plug Termination

For information on product disposal (end-of-life), please refer to this document: <https://nuwaves.com/wp-content/uploads/Product-Disposal-End-of-Life.pdf>

Contact NuWaves



NuWaves Engineering
132 Edison Drive
Middletown, OH 45044

www.nuwaves.com
product.sales@nuwaves.com
513.360.0800

 **NuWaves**
engineering
Trusted RF Solutions™