

1. INTRODUCTION

This instruction sheet is intended to provide you with "Instructions" on product application and a "Maintenance and Inspection Procedure" for:

TERMASHIELD* FERRULE CRIMPING DIES (USED IN TOOL NOS. 59500 AND 69270-1 MOD. 2)		
69204-1	69206-1	69866
69205-1	69865	

These dies are used to crimp:

- Un-insulated TERMASHIELD ferrules on single or multiple conductor shielded wires with a primary conductor insulation range of .085-.095.
- Pre-insulated TERMASHIELD ferrules on single or multiple conductor shielded wires with a primary conductor insulation range of .033-.130.

Basic instructions on the use of these tools and dies are provided in Section 2, "Instructions". For further instructions relative to the pneumatic tool, hand tool, die insertion and removal, etc., refer to the instructions packaged with these tools. Section 3 contains a "Maintenance and Inspection Procedure" which will enable you to establish and maintain a *die certification program*.

Dies are coated with oil to prevent rust and corrosion. Wipe this oil from dies, particularly from crimping area.

2. INSTRUCTIONS

2.1 SELECTION DATA FOR DIES AND FERRULES

2.1.1 Single Conductor Shielded Wire

- Determine the outside insulation diameter of the primary conductor.
- Locate this dimension in the appropriate primary conductor insulation range column of Figure 1. To the left of the insulation range you will find the numbers of the die and ferrule to use.

2.1.2 Multiple Conductor Shielded Wire

Determine which crimping die and ferrule to use with shielded wire having two or more conductors by using the following formula: Multiply the outside insulation diameter of one primary conductor by the "Multiplying Factor" (see Figure 2) listed opposite the total number of conductors in the wire. For example:

- If you had a 3-conductor shielded wire, you would first find the outside insulation diameter of one conductor. In this case, we will use an O.D. of .055.
- Opposite the number "3" (the number of primary conductors in wire) in column 1 of Figure 2, you will find a multiplying factor of 2.17.
- Multiply the O.D. of the one conductor (.055) by this factor (2.17). The result is .119. This figure (.119) is the primary conductor insulation range of the 3-conductor shielded wire.
- Next, refer to the insulation range of .115 to .130 in Figure 1. To the left of the .115 to .130 range you will find the crimping die and ferrule to use.

2.1.3 Color Coding

Crimping dies and ferrules are color coded as indicated in Figure 1, Column "C". The dies have color coded grooves. The metal portion of the ferrule is color coded by insulation diameter range. For example: Use dies color coded brown to crimp a brown ferrule.

2.2 WIRE STRIPPING

Strip shielded wire and ground wire as shown in Figure 1, Columns "A" and "B".

NOTE: For size and combination of ground wires that can be used, refer to Figure 1, Column "D". Ground wires may be solid or stranded except No. 20 which is stranded ONLY.

All illustrations and information contained in this instruction sheet are based on the latest product information available at the time of publication.

© Copyright 1962, 1963, 1967, 1973, 1978 by AMP Incorporated, Harrisburg, Pa. All International Rights Reserved. AMP Incorporated products covered by U.S. and Foreign Patents and/or Patents Pending.

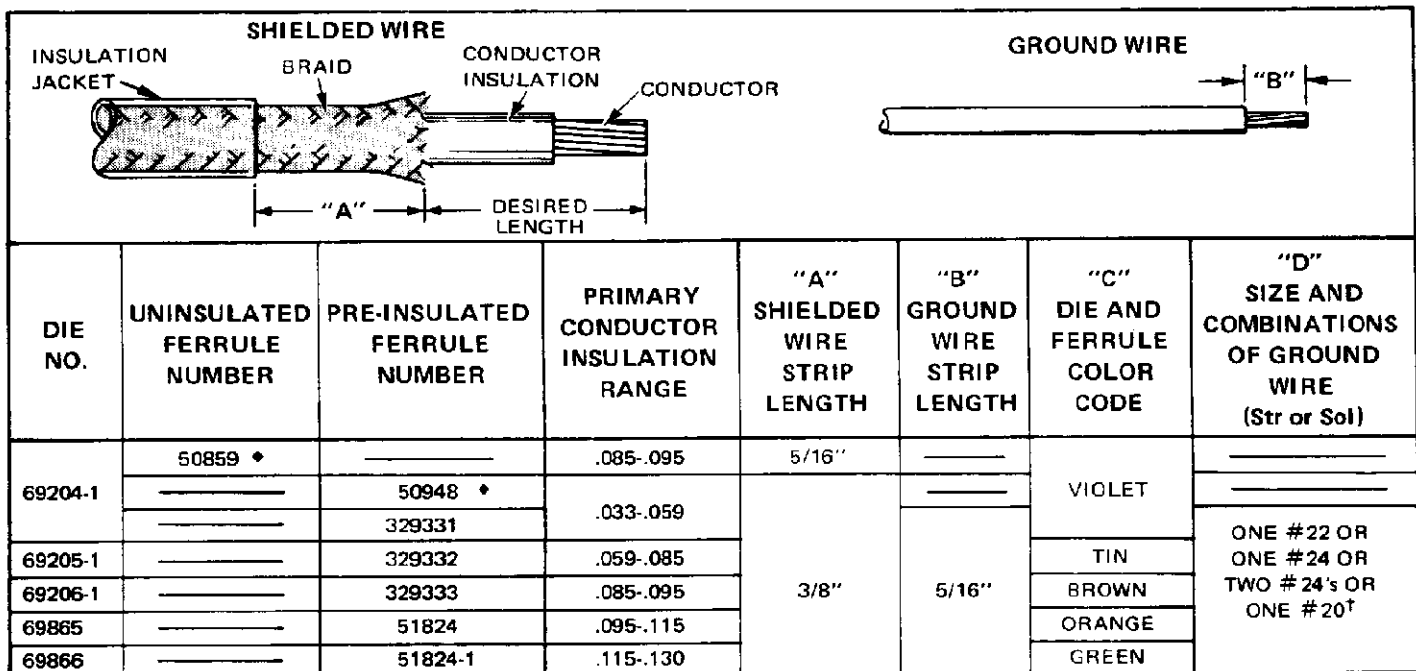

♦ Contains solder tab. See Figure 3.
† Stranded wire only.

Figure 1

NUMBER OF CONDUCTORS IN WIRE	MULTIPLYING FACTOR
2	2.00
3	2.17
4	2.42
5	2.57
6	2.82
7	3.04
8	3.25
9	3.45
10	3.64

Figure 2

2.3 CRIMPING PROCEDURE

Insert dies in tool.

NOTE: Refer to instructions shipped with tools for die insertion and tool operation before attempting to crimp ferrules.

2.3.1 Hand Tool

- (a) Insert stripped shielded wire into ferrules containing a solder tab, as shown in Figure 3.
 Insert stripped shielded wire and ground wire into ferrules without solder tab as shown in Figure 4.

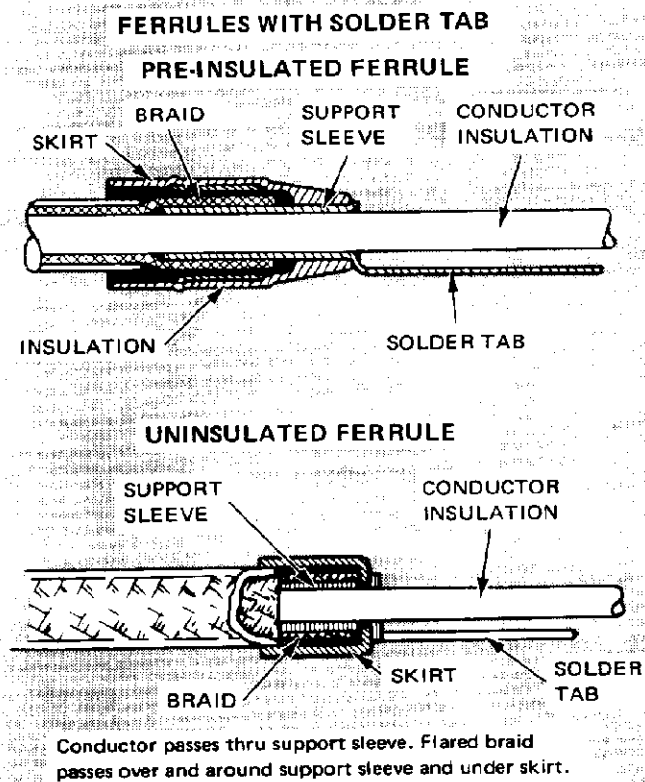
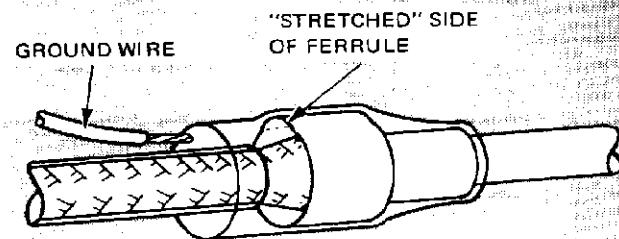

Figure 3

- (b) Open tool handles all the way.
 (c) Place ferrule in lower crimp area of dies. Push ferrule into dies until ferrule bottoms against stop plate. See Figure 5. Ensure that section of ferrule containing ground wire (when applicable) faces top of tool. See Figure 5.
 (d) Hold shielded wire and ground wire (if used) in position and close handles until the CERTI-CRIMP* ratchet releases. Handles will open automatically and crimped ferrule may be removed.

FERRULES WITH GROUND WIRE



Insert ground wire under stretched portion of ferrule skirt.

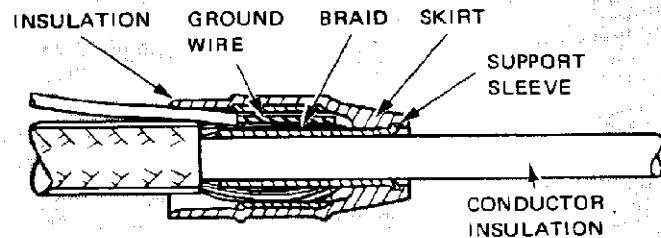

Conductor passes thru support sleeve. Flared braid passes over and around support sleeve and under skirt. To aid in insertion, slightly rotate the cable or the ferrule.

Figure 4

2.3.2 Pneumatic Tool

- (a) Insert stripped shielded wire into ferrules containing a solder tab, as shown in Figure 3.
 Insert stripped shielded wire and ground wire into ferrules without solder tab as shown in Figure 4.
 (b) Place ferrule in lower crimp area of dies. Push ferrule into dies until ferrule bottoms against stop plate. See Figure 5.
 (c) Ensure that section of ferrule containing ground wire (when applicable) faces top of tool as shown in Figure 5.
 (d) Hold shielded wire and ground wire (if used) in position and depress take-up lever to hold ferrule in place.
 (e) Simultaneously release take-up lever and depress trigger to complete crimp. Release trigger and remove crimped ferrule.

PUSH FERRULE ALL THE WAY INTO CRIMPING DIES UNTIL FERRULE BOTTOMS AGAINST STOP PLATE.

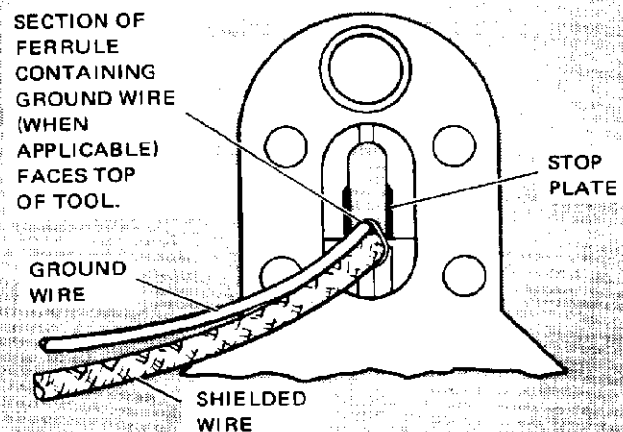

Figure 5

2.4 SOLDER TAB BENDING PROCEDURE

Hold ferrule stationary and bend tab as shown in Figure 6. Tab will automatically bend at the correct point.

NOTE: Do not try to bend tab at its base or tab may break.

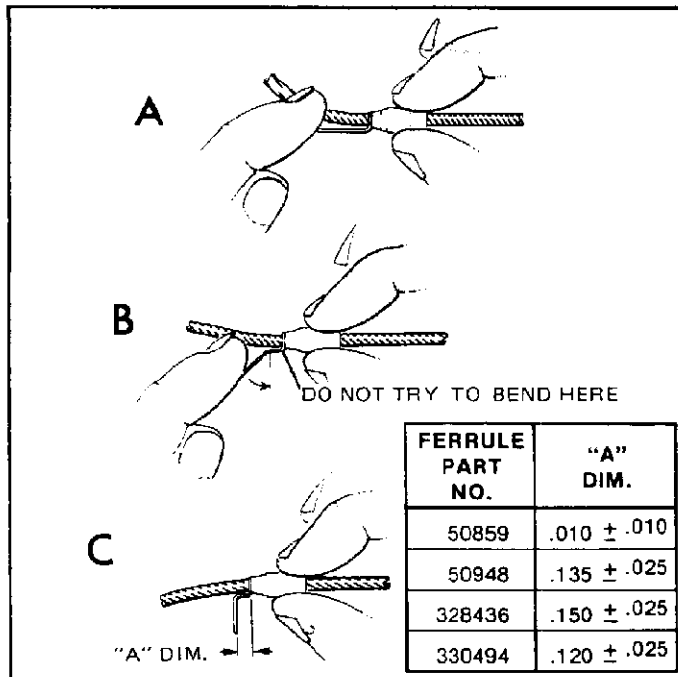

Figure 6

3. MAINTENANCE/INSPECTION PROCEDURE

AMP recommends that a maintenance/inspection program be performed periodically. This is necessary to assure that continued use of the dies will result in the same dependable and uniform terminations for which the dies were designed. We recommend an initial frequency of inspection of once a month. This frequency may be adjusted to suit your requirements through experience. The frequency of an inspection is dependent upon:

1. The care, amount of use, and handling of the dies.
2. The type and size of the products crimped.
3. The degree of operator skill.
4. The presence of abnormal amounts of dust and dirt.
5. Your own established standards.

All AMP* dies are thoroughly inspected before being shipped from the factory, however, since there is a possibility of die damage in shipment, AMP recommends that new dies be inspected in accordance with Section 3 when received in your plant.

3.1 CLEANING

Do not allow deposits of dirt, grease and foreign matter to accumulate in the die closure area and on the bottoming surfaces of the dies. These deposits may prevent the dies from bottoming fully and may also cause excessive wear in the die closure surfaces, thereby affecting the quality of the crimp. The dies should be wiped clean frequently with a clean cloth.

3.2 VISUAL INSPECTION

Visually inspect the die closure surfaces for broken or pitted conditions. Although dies may gage within permissible limits, worn or damaged die closure surfaces are objectionable and can affect the quality of the crimp. Examples of possible damaged die surfaces are shown in Figure 7.

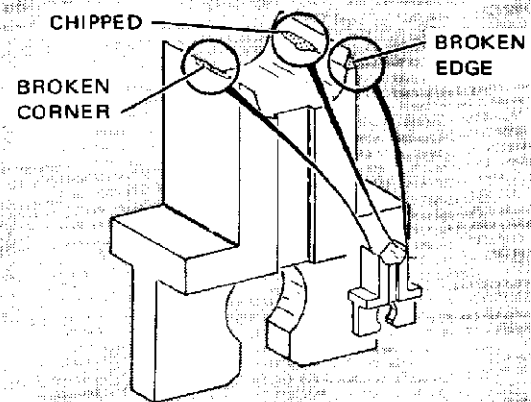

Figure 7

3.3 DIE CLOSURE INSPECTION

Every AMP die set is inspected and tested for proper die closure before being shipped from the factory. An inspection should, however, be performed periodically to measure the die closure.

The die closure inspection is accomplished using GO NO-GO plug gages. AMP neither manufactures nor sells plug gages, however a suggested plug gage design and the GO NO-GO dimensions of the plug gage members are listed in Figure 8. The following procedure is recommended for measuring the die closures.

- (a) Remove traces of oil or dirt from die crimping area and plug gage members.
- (b) Insert dies in tool.
- (c) When using hand tool, close handles of tool until dies bottom. Do not apply additional pressure to tool handles.
- (d) When using pneumatic tool, reduce air supply pressure to a range between 15-20 P.S.I. Depress trigger to bottom dies.
- (e) With crimping dies bottomed, check the die closure using the proper plug gage. Hold gage in straight alignment with the die closure and carefully try to insert without forcing, the GO member, and then the NO-GO member. See Figure 9. The GO member must pass completely through the die closure.
- (f) The NO-GO member may enter partially, but must not pass completely through the die closure.
- (g) If the die closures meet the GO NO-GO gage conditions, the dies may be considered dimensionally correct. If you find that the die closures do not conform with the GO NO-GO gage conditions, contact your local AMP field representative.

3.4 CERTI-CRIMP RATCHET INSPECTION

The CERTI-CRIMP ratchet feature on AMP hand tools should be checked to make certain that the ratchet does not release prematurely allowing dies to open before they have fully bottomed.

To check ratchet feature:

- (a) Make a test crimp using ferrule, shielded wire and ground wire as outlined in Paragraph 2.3.1. With wires mounted in ferrule, insert ferrule in dies and close handles until the ratchet is free, however, DO NOT RELAX PRESSURE ON TOOL HANDLES.
- (b) Bottoming is satisfactory if bottoming surfaces of the dies make contact with each other or if the clearance between the bottoming surfaces is .001" or less.
- (c) If .001" shim stock can be inserted completely between the bottoming surfaces of the dies, the dies are considered as not bottoming. Contact your local AMP field representative.

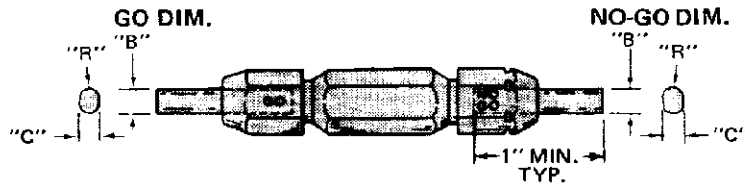
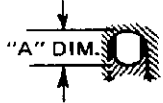
SUGGESTED PLUG GAGE DESIGN
DIE CLOSURE CONFIGURATION

DIE SET NUMBER	DIE CLOSURE DIM'S. "A"†		GAGE MEMBER†† DIM'S. "B"		"C" (MAX)	RADIUS "R" (MAX)
	GO	NO-GO	GO	NO-GO		
69204-1	.1780	.1840	.1780-.1783	.1839-.1840	.153	.082
69205-1	.1960	.2020	.1960-.1963	.2019-.2020	.171	.091
69206-1	.2130	.2190	.2130-.2133	.2189-.2190	.128	.100
69865	.2345	.2405	.2345-.2348	.2404-.2405	.192	.117
69866	.2580	.2640	.2580-.2583	.2639-.2640	.166	.083

† Plug gage dimensions apply when dies are bottomed, but not under pressure.

†† Material — Tool steel

Figure 8

INSPECTION OF CRIMPING DIES WITH PLUG GAGE

DIES BOTTOMED BUT NOT UNDER PRESSURE

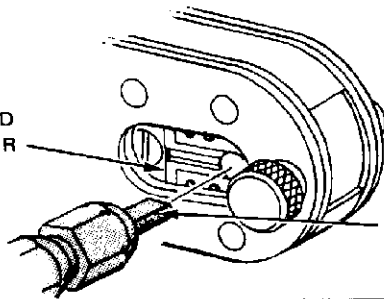

FLATS ON GAGE MUST BE PARALLEL TO LENGTH OF TOOL

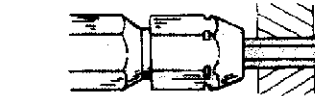

"GO" gage must pass completely through the die closure.

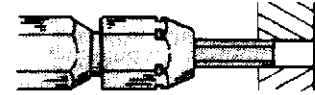

"NO-GO" gage may enter partially, but must not pass completely through the die closure.

Figure 9

3.5 REPLACEMENT PARTS

It may be advantageous to stock certain replaceable parts to prevent loss of production time. Figure 10 lists the customer replaceable parts that can be purchased from AMP Incorporated. Parts other than those listed on Figure 10 should be replaced by AMP Incorporated to insure proper CERTI-

CRIMP ratchet adjustments. For tool repair service or CERTI-CRIMP ratchet adjustment the tools should be returned to AMP Incorporated, Tool Repair Service, 1523 N. Fourth Street, Harrisburg, Pennsylvania 17105, or a wholly owned subsidiary of AMP Incorporated.

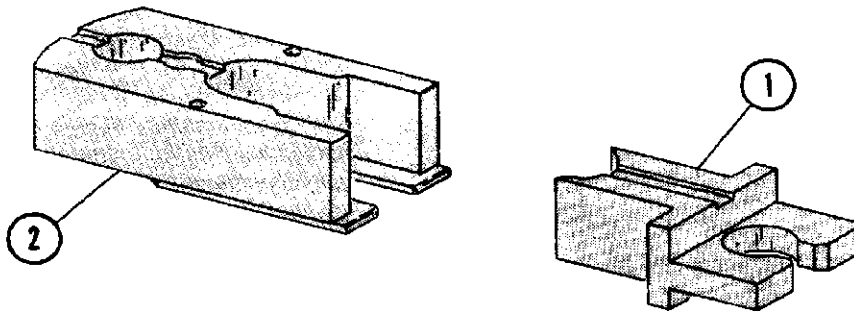

ITEM	DESCRIPTION	DIE SET NUMBERS				
		69204-1	69205-1	69206-1	69865	69866
1	MALE DIE	2-306144-7	2-306144-8	2-306144-9	45901-4	45901-5
2	FEMALE DIE	305938-1	305938-2	305938-3	2-305938-2	2-305938-3

Figure 10

REL. DATE	REV. DATE	APPROVALS	
5-17-62	3-1-78	ENG. <i>Ivan P. Dyant</i>	PUB. <i>Paul Felty</i>