



Female socket block, Push-in connection, No. of poles: 4, Width: 21.6 mm, Colour: Pebble grey

### Business data

Article number	13110.0
Article name	PBK 4101/4/5,00-KD LG
GTIN (EAN)	4044211041847
Colour	Pebble grey
Packaging unit	50
Quantity unit	PC
Packaging type	Carton
Type of banding	Without
Weight per piece (not including packaging)	2.1 g
Weight per piece (including packaging)	2.55 g
Unit of weight	G
Customs number	85366930
Country of origin	QU

### Technical data

#### Dimensions

Length	12.5 mm
Length of the pin	3.6 mm
Width	21.6 mm
Width left	3.5 mm
Width right	3.1 mm
Height	9.2 mm
Drill hole diameter	1 mm
Diameter of connecting pin	0.4 mm
Pitch	5 mm

#### Ratings

Rated voltage	250 V
Rated current	17.5 A
Rated cross-section	1.5 mm <sup>2</sup>
Rated impulse voltage	2 kV
Overvoltage category	III
Contamination degree	3

#### Connection data

Connection principle	Push-in connection
Connection type of PCB	Connecting contact
Type of attachment to circuit board	Solder connection
Angle of PCB/wire connection	0°/180° (horizontal)
No. of poles	4
Number of levels	1
Wire cross-section single-core (rigid) / stranded, min.	0.08 mm <sup>2</sup>
Wire cross-section single core (rigid)/stranded, max.	2.5 mm <sup>2</sup>
Wire cross-section stranded, min.	0.5 mm <sup>2</sup>
Wire cross-section stranded, max.	1.5 mm <sup>2</sup>
Wire cross-section stranded with wire-end ferrules, min.	0.14 mm <sup>2</sup>
Wire cross-section stranded with wire-end ferrules, max.	1 mm <sup>2</sup>
Wire cross-section AWG, min.	20
Wire cross-section AWG, max.	14
Stripping length	9 mm

### Technical data

#### Materials

Insulation housing	Polyamide 6.6
Flammability class UL 94	V-0
Working temperature, min.	-30 °C
Working temperature, max.	105 °C
Terminal spring	Stainless steel
Soldering lug	Copper alloy

#### Further technical data

Storage temperature, min.	-40 °C
Storage temperature, max.	105 °C
Insulation resistance	1*10 <sup>13</sup> Ohm x cm
Creepage-current resistance	CTI 600
Glow wire flammability index GWFI	GWFI 850
GWFI after-glow time	30 Sek.
Glow wire ignition temperature GWIT	GWIT 775 °C
GWIT exposure time	5 Sek.
Connection cycles, in compliance with standard	10
Recommended wave soldering temperature	265 °C
Recommended wave soldering duration, min.	3 Sek.
Recommended wave soldering duration, max.	4 Sek.

#### Environmental Product Compliance

REACH Conform	yes
REACH Reference date	2022-06-10
REACH Candidate Substance Note	No
RoHS Conform	yes

### Approvals

#### cUL Recognized

cUL approval	CSA 22.2 No.158
cUL Usegroup B: rated voltage	300 V
cUL Usegroup B: rated current	10 A
cUL Usegroup D: rated voltage	300 V
cUL Usegroup D: rated current	10 A
cUL wire cross-section single-core (rigid) AWG, min.	20
cUL wire cross-section single-core (rigid) AWG, max.	14
cUL wire material	Cu
cUL Recognized	1

#### UL Recognized

UL approval	UL 1059
UL Usegroup B: rated voltage	300 V
UL Usegroup B: rated current	10 A
UL Usegroup D: rated voltage	300 V
UL Usegroup D: rated current	10 A
UL wire cross-section single-core (rigid) AWG, min.	20
UL wire cross-section single-core (rigid) AWG, max.	14
UL wire material	Cu
UL factory wiring	1
UL field wiring	1
UL Recognized	1

#### VDE approval

VDE approval	DIN EN 60998
VDE approval granted	yes
VDE rated voltage	250 V
VDE rated current	17.5 A
VDE rated current wire cross-section rigid, max.	17.5 A
VDE rated impulse voltage	2 kV
VDE wire cross-section rigid, min.	0.5 mm <sup>2</sup>
VDE wire cross-section rigid, max.	2.5 mm <sup>2</sup>
VDE overvoltage category	III
VDE contamination degree	3

### Media

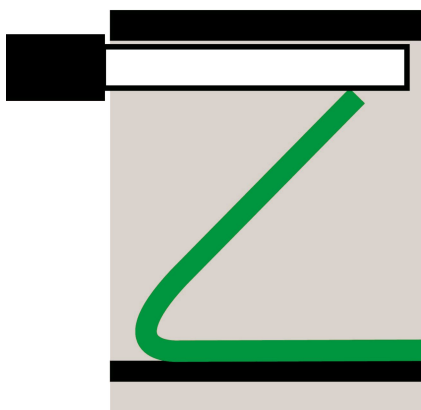
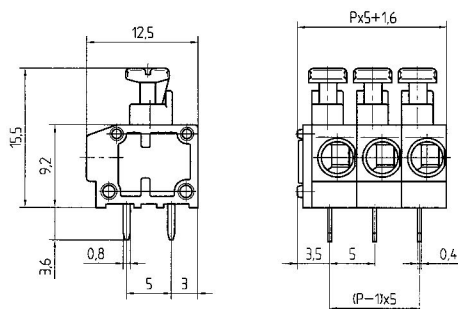

---

### Accessories

---