

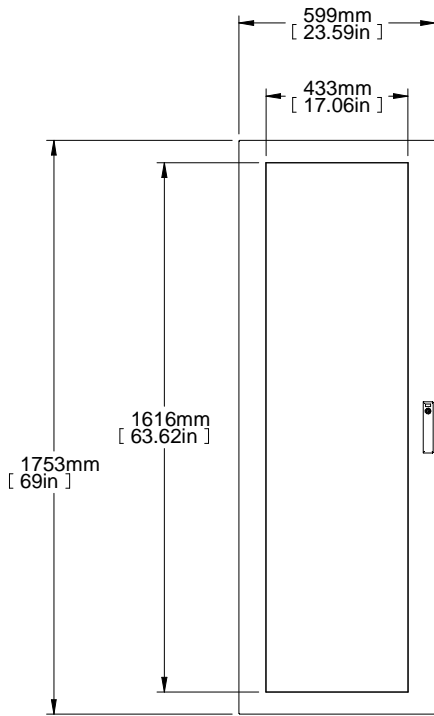

TOP VIEW

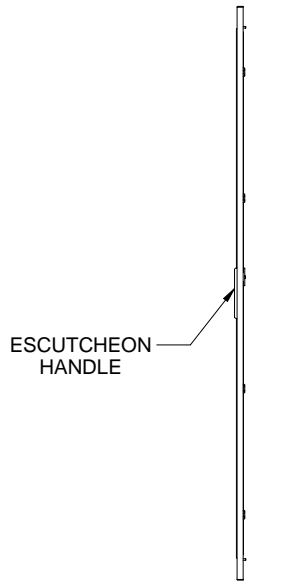

FRONT VIEW



SIDE VIEW

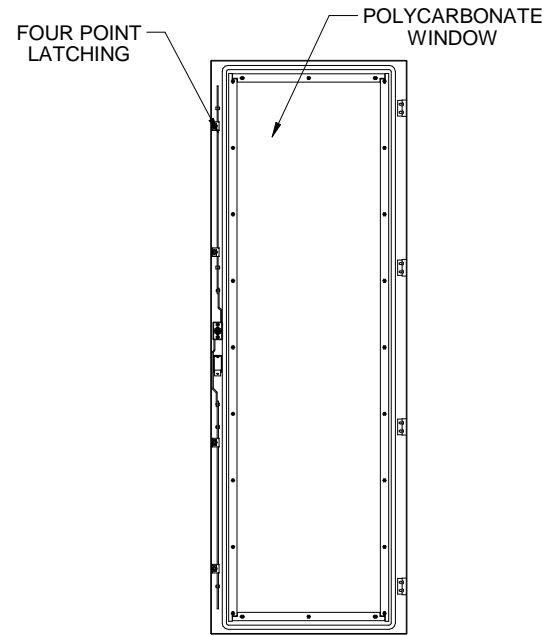

REAR VIEW

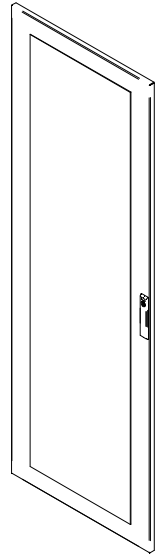

ISOMETRIC

PART NUMBERS	
HMEDW186	PAINTED TEXTURED GRAY RAL7035
NOTES	
See Hammond Website for Additional Accessories.	
Français	
Pour tous les détails sur nos produits, s'p veuillez consulter notre site www.hammondmfg.com .	
Data subject to change without notice. Isometric drawing not to scale.	
Les données sont sujettes à changement sans préavis.	
	HAMMOND MANUFACTURING®
	www.hammondmfg.com
PART NO.	HMEDW186