

CW020-SD00

10-14Vdc Input, 30A, 0.8-5.0Vdc Output

Data Sheet

The **CW020-SD00** non-isolated dc-dc converter delivers exceptional electrical and thermal performance. Operating from a 10Vdc-14Vdc input, this is the converter of choice for Intermediate Bus Architecture (IBA) and Distributed Power Architecture applications that require high efficiency, tight regulation, and high reliability in elevated temperature environments with low airflow.

非絶縁型DC/DCコンバータの**CW020-SD00**は極めて優れた電気的特性、及び温度特性を提供します。

入力電圧は10V-14Vで動作します。このコンバータは、高効率、高い出力電圧精度、高温、及び風量の少ない環境での高信頼性が要求されるIBA、又はDPAでの使用に最適です。

The **CW020-SD00** converter delivers 30A of output current at a tightly regulated programmable output voltage of 0.8Vdc to 5.0Vdc. The thermal performance of the **CW020-SD00** is excellent: no derating is needed up to 60°C with 400LFM airflow (3.3Vout setting).

CW020-SD00 は高い電圧精度でプログラム可能な出力電圧 0.8~5.0Vdcで 30Aの出力電流を供給します。**CW020-SD00** の温度特性はクラス最高レベルです。400LFMの条件で60°Cまでデレーティングを必要としません。(3.3V出力設定時)

This leading edge thermal performance results from electrical, thermal and packaging design that is optimized for high density circuit card conditions. Extremely high quality and reliability are achieved through advanced circuit and thermal design techniques and FDK's state of the art in-house manufacturing processes and systems.

回路設計、放熱設計、及びパッケージング設計の結果である最先端の温度特性は、高密度実装回路用に最適化されています。非常に優れた品質と信頼性は高度な回路設計、温度設計技術、及びFDKの最先端の自社製造プロセスによりもたらされます。

Applications

- Intermediate Bus Architecture
中間バス構成システム
- Telecommunications
テレコムシステム
- Data/Voice processing
データ処理システム
- Distributed Power Architecture
分散型電源システム
- Computing (Servers, Workstations)
コンピュータ関係(サーバー、ワークステーション)

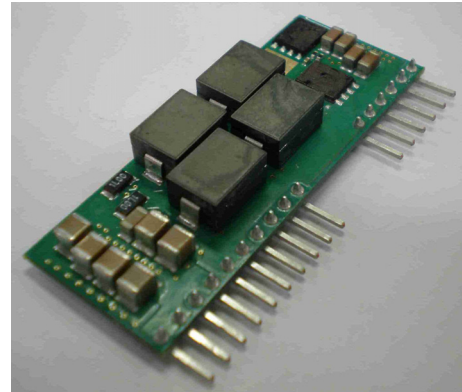

CW020-SD00

Features

- RoHS compliant RoHS準拠
- Delivers up to 30A
30Aまで供給可能
- Parallel operation without external components
Load sharing accuracy: $\pm 10\%$ ($\pm 3.0A$)
Up to four (4) converters can be paralleled
並列運転可能
負荷共有精度: $\pm 10\%$ ($\pm 3.0A$)
4台までコンバータを並列接続可能
- High efficiency, no heatsink required
高効率-放熱器が不要
- Small size and low profile: 2.00" x 0.752" x 0.335"
小型(50.8 x 19.1 x 8.5mm)
- No minimum load required
最小負荷は不要
- Start up into pre-biased output
出力にプリバイアスがあっても起動可能
- Negative logic remote ON/OFF option
- Fully protected: OCP, OTP, UVLO
保護機能: 過電流、加熱、低電圧ロックアウト
- High reliability, MTBF = 1.0 Million Hours (30°C)
高信頼性: MTBF = 1.0 Million Hours (30°C)
- UL60950 recognition in U.S. & Canada, and CB Scheme certification per IEC60950 Pending
UL60950、CB Scheme 認証 (予定)
- All materials meet UL94, V-0 flammability rating
全ての部品は UL94 V-0に適合
- Meets conducted emissions requirements of FCC Class B and EN55022 Class B with external filter
外部フィルター付きの状態FCCクラスB、及びEN55022クラスBを満足します。

CW020-SD00

Data Sheet

10-14Vdc Input, 30A, 0.8-5.0Vdc Output

Electrical Specifications 電氣的仕様

All specifications apply over specified input voltage, output load, and temperature range, unless otherwise noted.

注記が無い場合、全ての仕様は指定された入力電圧、負荷、温度範囲で適用されます。

Conditions: $T_a=25\text{degC}$, Airflow=200LFM (1.0m/s), $V_{in}=12\text{Vdc}$, unless otherwise specified.

PARAMETER	NOTES	MIN	TYP	MAX	UNITS
ABSOLUTE MAXIMUM RATINGS ¹					
Input Voltage	Continuous	-0.3		15	Vdc
Operating Temperature	Ambient temperature	0		85	°C
Storage Temperature		-40		125	°C
Output Voltage		0.7		5.0	Vdc
FEATURE CHARACTERISTICS					
Switching Frequency			600		kHz
Output Voltage Programming Range	By external resistor. See trim table-1	0.8		5.0	Vdc
Remote Sense Compensation				0.5	Vdc
Turn-On Delay Time	Full resistive load				
with V_{in} (module enabled, then V_{in} applied)	From $V_{in}=V_{in}(\text{min})$ to $0.1*V_{out}(\text{nom})$		5		mS
with Enable (V_{in} applied, then enabled)	From enable to $0.1*V_{out}(\text{nom})$		5		mS
Rise Time (Full resistive load)	From $0.1*V_{out}(\text{nom})$ to $0.9*V_{out}(\text{nom})$		5		mS
ON/OFF Control (Negative)					
Module Off		2.4		V_{in}	Vdc
Module On		-5		0.8	Vdc
Power Good ²	Low=Off, High=On				
PGOOD Voltage Low	IPGOOD = 2mA		0.1	0.2	V
PGOOD Leakage Current	VPGOOD = 5V			+/-2	uA
PGOOD Trip Level	For stable output voltage		-10		%
	For stable output voltage		+10		%
Parallel Redundancy ³	100% of full load		±3		A

¹ Absolute Maximum Ratings 絶対最大定格

Stresses in excess of the absolute maximum ratings may lead to degradation in performance and reliability of the converter and may result in permanent damage.

絶対最大定格を超えたストレスは、性能の低下、長期信頼性の低下、及びモジュールの破損を引き起こすことがあります。

² Power Good

The signal is HIGH when the output is between 90% and 110% of rated voltage.

出力電圧が定格電圧の90%~110%のとき、Power Good信号は"High"になります。

³ Parallel Redundancy

The current deviation between any 4 units operating in parallel is +/-3A typically.

4台並列運転時の各コンバータ間の電流ばらつきはTyp.±3Aです。

CW020-SD00

Data Sheet

10-14Vdc Input, 30A, 0.8-5.0Vdc Output

Electrical Specifications (Continued) 電氣的仕様 (続き)

Conditions: $T_a=25\text{degC}$, Airflow=200LFM (1.0m/s), $V_{in}=12\text{Vdc}$, unless otherwise specified.

PARAMETER	NOTES	MIN	TYP	MAX	UNITS
INPUT CHARACTERISTICS					
Operating Input Voltage Range		10	12	14	Vdc
	Vout=5.0V	10.8	12	14	Vdc
Input Under Voltage Lockout ⁴					
Turn-on Threshold			4.5		Vdc
Turn-off Threshold			3.4		Vdc
Maximum Input Current ⁵	30Adc out at 10.0Vdc in				
	Vout=5.0Vdc (25Adc out at 10.8Vdc in)			12.5	Adc
	Vout=3.3Vdc (30Adc out at 10.0Vdc in)			10.9	Adc
	Vout=2.5Vdc (30Adc out at 10.0Vdc in)			8.4	Adc
	Vout=2.0Vdc (30Adc out at 10.0Vdc in)			6.8	Adc
	Vout=1.8Vdc (30Adc out at 10.0Vdc in)			6.2	Adc
	Vout=1.5Vdc (30Adc out at 10.0Vdc in)			5.2	Adc
	Vout=1.2Vdc (30Adc out at 10.0Vdc in)			4.3	Adc
	Vout=1.0Vdc (30Adc out at 10.0Vdc in)			3.6	Adc
Input Stand-by Current (module disabled)			2.4		mA
Input No Load Current	Vout=5.0Vdc		360		mA
	Vout=3.3Vdc		260		mA
	Vout=2.5Vdc		200		mA
	Vout=2.0Vdc		160		mA
	Vout=1.8Vdc		145		mA
	Vout=1.5Vdc		115		mA
	Vout=1.2Vdc		95		mA
	Vout=1.0Vdc		75		mA

⁴ Input Under Voltage Lockout

It is Turn-on input voltage of the converter. The converter is Turn-on when input voltage is higher than typically 4.5V and Turn-off when it is lower than typically 3.4V.

コンバータが起動する入力電圧のことです。入力電圧がTyp4.5Vを上回るとコンバータがONし、3.4Vを下回るとコンバータはOFFします。

⁵ Maximum Input Current

This spec shows input currents are less than indicated values for each output voltages at specified conditions in NOTES (ex. Input current is less than 12.5A at 10.8Vdc in, 5.0Vdc-25Adc out). The output current is limited to 35A with the overcurrent protection circuit.

この項目はNOTESに記載された条件と各出力電圧設定時の最大入力電流を示します。(例えば10.8V入力、5.0V/25A出力時の入力電流は12.5A未満)。出力電流は過電流保護回路により35Aが上限となります。

CW020-SD00

Data Sheet

10-14Vdc Input, 30A, 0.8-5.0Vdc Output

Electrical Specifications (Continued) 電氣的仕様 (続き)

Conditions: $T_a=25\text{degC}$, Airflow=200LFM (1.0m/s), $V_{in}=12\text{Vdc}$, unless otherwise specified.

PARAMETER	NOTES	MIN	TYP	MAX	UNITS
OUTPUT CHARACTERISTICS					
Output Regulation					
Over Line	Full resistive load		+/-0.1		%Vout
Over Load	From no load to full load		+/-0.4		%Vout
Output Voltage Range ⁶		-2.5		+2.5	%
Output Ripple and Noise BW=20MHz	Over line, load and temperature (Fig. E) $C_o=47\mu\text{F} \times 2$ ceramic + $1\mu\text{F}$ ceramic				
Peak to Peak	Vout=1.0Vdc		15	30	mVp-p
Peak to Peak	Vout=5.0Vdc		30	80	mVp-p
RMS	Vout=1.0Vdc		5		mVrms
RMS	Vout=5.0Vdc		25		mVrms
External Load Capacitance ⁷	Plus full load (resistive)				
Min ESR > 1mΩ				1,000	μF
Output Current Range		0		30	A
Output Current Limit Inception (Iout)	Vout=3.3Vdc		35		A
Output Short-Circuit Current	Short=10mΩ, Vout=3.3Vdc set		30		Arms
DYNAMIC RESPONSE					
Iout step from 15A to 30A with di/dt= 5A/μS	$C_o=47\mu\text{F} \times 2$ ceramic + $1\mu\text{F}$ ceramic		180		mV
Setting time (Vout < 10% peak deviation)			40		uS
Iout step from 30A to 15A with di/dt= 5A/μS	$C_o=47\mu\text{F} \times 2$ ceramic + $1\mu\text{F}$ ceramic		180		mV
Setting time (Vout < 10% peak deviation)			40		uS
EFFICIENCY					
	Full load (30A)				%
	Vout=5.0Vdc (25Adc)		94		%
	Vout=3.3Vdc		92		%
	Vout=2.5Vdc		91		%
	Vout=2.0Vdc		90		%
	Vout=1.8Vdc		89		%
	Vout=1.5Vdc		88		%
	Vout=1.2Vdc		86		%
	Vout=1.0Vdc		85		%

⁶ Output Voltage Range

Over all operating input voltage, resistive load and temperature conditions until end of life.

動作入力電圧、負荷、環境温度、寿命など全てを含んだ値です。

⁷ External Load Capacitance

This spec shows the converter guarantees to turn-on with specified values of external capacitance, not require them.

この項目は規定した値のコンデンサが付いた状態で起動を保証するもので、必須ではありません。

CW020-SD00

10-14Vdc Input, 30A, 0.8-5.0Vdc Output

Data Sheet

Operation

Input and Output Impedance

The **CW020-SD00** converter should be connected to a DC power source using a low impedance input line. In order to counteract the possible effect of input line inductance on the stability of the converter, the use of decoupling capacitors placed in close proximity to the converter input pins is recommended. This will ensure stability of the converter and reduce input ripple voltage. Although low ESR Tantalum or other capacitors should typically be adequate, very low ESR capacitors (ceramic, over 200 μ F) are recommended to minimize input ripple voltage. The converter itself has on-board internal input capacitance of 10 μ F with very low ESR (ceramic).

CW020-SD00と入力電源間は低インピーダンスで接続してください。コンバータの安定性に影響のある入力インダクタンスを抑えるため、コンバータの入力ピンの近傍にデカップリングコンデンサを付加することをお勧めします。これによりコンバータの安定動作を確実にし、入力リップル電圧を抑制します。低ESRタンタル、又はその他のコンデンサも一般的には問題ありませんが、入力リップルを最小にするためには、非常に低ESRコンデンサ(セラミックで200 μ F以上)を推奨します。コンバータ自身は入力回路に極低ESRの10 μ Fセラミック入力コンデンサを搭載しています。

The **CW020-SD00** is capable of stable operation with no external capacitance on the output. To minimize output ripple voltage, the use of very low ESR ceramic capacitors is recommended. These capacitors should be placed in close proximity to the load to improve transient performance and to decrease output voltage ripple.

CW020-SD00は出力に外付けコンデンサが無い状態でも安定して動作します。出力リップルを最小にするため、極低ESRのセラミックコンデンサの接続を推奨します。過渡時の特性向上と出力リップル低減のために負荷の近傍に極低ESRセラミックコンデンサを実装することをお勧めします。

Note that the converter has a SENSE pin to counteract voltage drops between the output pins and the load. However, the impedance of the line from the converter output to the load should thus be kept as low as possible to maintain good load regulation.

このコンバータは出力端子と負荷間の電圧ドロップを補正するセンス端子を持っています。しかし、精度の高い負荷特性を保持するために、コンバータの出力から負荷までのラインインピーダンスは可能な限り低くしてください。

ON/OFF (Pin 14)

The ON/OFF pin (pin 14) can be used to turn the converter on or off remotely using a signal that is referenced to GND (pin 5 & 6 & 11), as shown in Fig. A. To turn the converter on Pin 14 should be at logic low or left open, and to turn the converter off Pin 14 should be at logic high or connected to Vin.

ON/OFF端子(14番ピン)は図Aのように、グランド(5番、6番、及び11番ピン)を基準としたリモート信号によりコンバータをON/OFFするのに使われます。コンバータをONするには14番ピンをLowレベル、又は未接続とし、コンバータをOFFするには14番ピンをHighレベル、又はVinと接続とします。

The ON/OFF pin (pin14) is internally pulled-down. A TTL or CMOS logic gate or an open collector (open-drain) transistor can be used to drive Pin 14. When using an open collector (open-drain) transistor, a pull-up resistor, $R^*=75k\Omega$, should be connected to Vin (See Fig.A).

- The device driving Pin 14 must be capable of:
- (b) Sinking up to 0.2mA at low logic level ($\leq 0.8V$)
 - (c) Sourcing up to 0.25mA at high logic level (2.4–5V)
 - (d) Sourcing up to 0.75mA when connected to Vin

ON/OFFピンはモジュール内部でプルダウンされています。TTL、CMOSロジック、又はオープンコレクタ(オープンドレイン)のトランジスタがON/OFFピンの操作に使用可能です。オープンコレクタ(オープンドレイン)のトランジスタを使用する時は75k Ω のプルアップ抵抗をVinに接続してください。(図A参照)
ON/OFFピンを操作するデバイスには下記能力が必要です。
(b) 0.8V以下のLowレベルで0.2mAまでのシンク能力
(c) 2.4V-5VのHighレベルで0.25mAまでの供給能力
(d) Vin接続時には0.75mAまでの供給能力

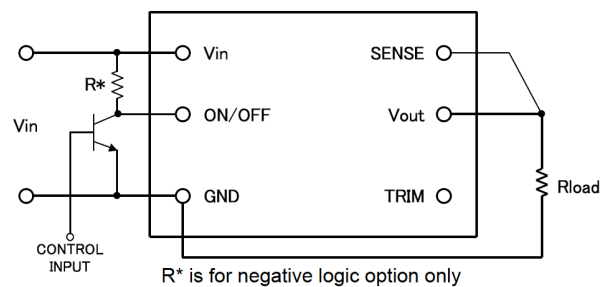

Fig. A: Circuit configuration for remote ON/OFF

CW020-SD00

10-14Vdc Input, 30A, 0.8-5.0Vdc Output

Data Sheet

Remote Sense (Pin 3)

The CW020-SD00 converter incorporates a remote sense function to compensate for voltage drops between Vout (pin 1, 2 & 4) and the load. SENSE (pin 3) should be connected via a separate trace to a point close to the load or to a point where regulation is required; see Fig. B. This trace should be located in proximity to a ground plane to minimize noise pick-up. Note that GND (pin 5 & 6) does not have a sense function: good connectivity to a ground plane is needed for low voltage drop.

CW020-SD00コンバータはVout(1番、2番、及び4番ピン)と負荷の間で起こる電圧低下を補正するために、リモートセンス機能を有しています。SENSE(3番ピン)は負荷端、又は補正が必要な箇所に個別の配線で接続してください。(図B参照) この配線はノイズの影響を最小にするため、グラウンドに近接して配線してください。GND(5番、及び6番ピン)はセンス機能がありませんので、電圧低下を少なくするためにグラウンドに良好な接続が必要です。

In case the remote sense function is not required, SENSE (pin 3) must be connected to Vout (Pin 1, 2 & 4). In the absence of this connection, the converter will provide a slightly higher output voltage than that specified.

リモートセンス機能が必要無い場合は、SENSE(3番ピン)はVout(1番、2番、及び4番ピン)に接続してください。接続が無い場合、コンバータは出力電圧規格より若干高い電圧を出力します。

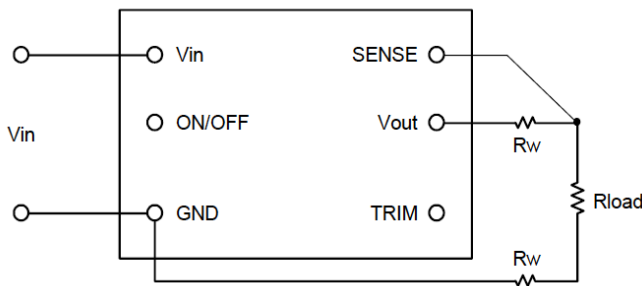

Fig. B: Remote Sense Circuit Configuration

Output Voltage Programming (Pin 7)

The output voltage of the CW020-SD00 converter can be programmed from 0.8V to 5.0V by using an external resistor or a voltage source.

CW020-SD00の出力電圧は外部抵抗を接続するか、又は外部電源を印加することで0.8V~5.0Vまで可変可能です。

External Resistor

An external trim resistor, R_{TRIM} , should be connected between TRIM (pin 7) and GND (pin 5, 6 & 11); see Fig.C. The value of R_{TRIM} , in kohm, for a desired output voltage, V_{O-REQ} , in V, is given by:

外部抵抗 R_{TRIM} はTRIM端子(7番ピン)とGND端子(5番、6番及び11番ピン)の間に接続してください。図Cを参照。 R_{TRIM} の定数、及び必要な出力電圧 V_{O-REQ} は次の式により求めます。

$$R_{TRIM} = \frac{1.5}{(V_{O-REQ} - 0.7)} - 0.1 \text{ [k}\Omega\text{]}$$

Note that the tolerance of a trim resistor will affect the tolerance of the output voltage. Standard 1% or 0.5% resistors may suffice for most applications; however, a tighter tolerance can be obtained by using two resistors in series instead of one standard value resistor.

R_{TRIM} の公差は出力電圧の公差に影響します。ほとんどの使用状況においては、標準的な1%又は0.5%品の抵抗で十分です。しかしながら、より厳しい出力精度のためには、抵抗1本よりも2本を直列に使用します。

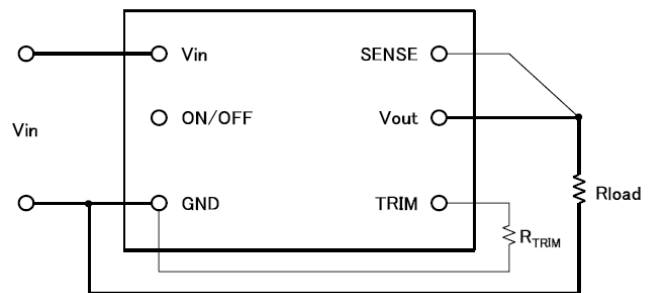

Fig. C: Configuration for programming output voltage

Table 1 lists calculated values of R_{TRIM} for common output voltages. For each value of R_{TRIM} , Table 1 also shows the closest available standard resistor value.

Table 1に一般的な出力電圧を設定する際の抵抗値を表示します。また Table 1に標準的な抵抗を使用した場合の近似値も表示しています。

Table 1: Trim Resistor Value		
V_{O-REQ} [V]	R_{TRIM} [k Ω]	The Closest Standard Value [k Ω]
0.7	Open	
0.8	14.900	14.900
1.0	4.900	4.930
1.2	2.900	2.910
1.5	1.775	1.780
1.8	1.264	1.260
2.0	1.054	1.050
2.5	0.733	0.732
3.3	0.477	0.475
5.0	0.249	0.249

CW020-SD00

10-14Vdc Input, 30A, 0.8-5.0Vdc Output

Data Sheet

External Voltage Source

To program the output voltage using an external voltage source, a voltage, V_{CTRL} , should be applied to the TRIM pin. Use of a series resistor, R_{EXT} , between the TRIM pin and the programming voltage source is recommended to make trimming less sensitive.

外部電源を使って出力電圧を可変するには、TRIM端子に V_{CTRL} の電圧を印加します。電圧設定が敏感すぎるのを避けるため、TRIM端子と外部電源間に抵抗を直列に接続することをお勧めします。

The voltage of the control voltage V_{CTRL} , in V, for a given value of R_{EXT} , in $k\Omega$, is given by:

V_{CTRL} 電圧は下記の式により算出が可能です。

$$V_{CTRL} = 0.6 - \frac{(0.1 + R_{EXT})(V_{O-REQ} - 0.7)}{2.5} [V]$$

Table 2 lists values of V_{CTRL} for $R_{EXT}=0$ and $R_{EXT}=4.7k\Omega$.

Table 2は $R_{EXT}=0$ の時と $R_{EXT}=2.2k\Omega$ の時の V_{CTRL} 電圧を表しています。

Table 2: Control Voltage [Vdc]		
V_{O-REG} [V]	V_{CTRL} ($R_{EXT}=0$)	V_{CTRL} ($R_{EXT}=2.2k$)
0.7	0.600	0.600
0.8	0.596	0.508
1.0	0.588	0.324
1.2	0.580	0.140
1.5	0.568	-0.136
1.8	0.556	-0.412
2.0	0.548	-0.596
2.5	0.528	-1.056
3.3	0.496	-1.792
5.0	0.428	-3.356

Protection Features

Input Under-Voltage Lockout

From a turned-on state, the converter will turn off automatically when the input voltage drops below typically 3.4V. It will then turn on automatically when the input voltage reaches typically 4.5V.

動作している状態で、入力電圧がTYPで3.4V未満になるとコンバータは自動的に停止します。また、入力電圧がTYPで4.5V以上になるとコンバータは自動的に動作を開始します。

Output Over-Current Protection (OCP)

The converter is self-protected against over-current and short circuit conditions.

このコンバータは過電流と負荷短絡に対し自己保護します。

Over-Temperature Protection (OTP)

The converter is self-protected against over-temperature conditions. In case of overheating due to abnormal operation conditions, the converter will turn off automatically. It will turn back on automatically once it has cooled down to a safe temperature (auto-reset).

このコンバータは加熱保護機能を有しています。異常な動作条件によって加熱状態になると、このコンバータは自動的に停止します。安全な温度にまで下がると自動的に復帰します。(自動リセット)

Safety Requirements

This converter meets North American and International safety regulatory requirements per UL60950 and EN60950. (Pending)

このコンバータは北米及び国際的な安全基準であるUL60950とEN60950に適合しています。(取得予定)

The converter meets SELV (safety extra-low voltage) requirements under normal operating conditions in that the output voltages are ELV (extra-low voltage) when all the input voltages are ELV. Note that the converter is not internally fused: to meet safety requirements, a fast acting in-line fuse with a maximum rating of 35 A must be used in the positive input line.

このコンバータは通常の動作条件下においてSELVの条件を満たしており、入力電圧がELVであれば出力電圧もELVとなります。このコンバータは内部にヒューズを持っていませんので、安全規格に適合させるためには、入力ラインのプラス側に即断型で最大定格35Aのヒューズを接続してください。

CW020-SD00

10-14Vdc Input, 30A, 0.8-5.0Vdc Output

Data Sheet

Characterization

Overview

The converter has been characterized for several operational features, including thermal derating (maximum available load current as a function of ambient temperature and airflow), efficiency, power dissipation, start-up and shutdown characteristics, ripple and noise, and transient response to load step-changes.

このコンバータは温度デレーティング、効率、電力損失、スタートアップ時、及びシャットダウン時の動作、リップル・ノイズ、動的負荷変動などを含む、さまざまな動作状態で特徴付けられます

Figures showing data plots and waveforms for different output voltages are presented in the following pages. The figures are numbered as Fig. *V-#, where *V indicates the output voltage, and # indicates a particular plot type for that voltage. For example, Fig *V-8 is a plot of efficiency vs. load current for any output voltage *V.

各出力電圧時のデータ、及び波形の図は以後のページに掲載されています。図はFig *V-#のように番号付けされており、*Vは出力電圧を表し、#は特定のプロットを表します。例えば Fig *V-8とあれば、*V出力での効率特性を表します。

Test Conditions

To ensure measurement accuracy and reproducibility, all thermal and efficiency data were taken with the converter soldered to a standardized thermal test board. The thermal test board was mounted inside FDK's custom wind tunnel to enable precise control of ambient temperature and airflow conditions.

測定精度、及び再現性を確実にするために、全ての温度、及び効率データは標準化された温度評価ボードにコンバータを半田付けして取得しています。温度評価ボードをFDK特製の風洞実験設備内に設置することで、環境温度、及び風量を精密に管理しています。

The thermal test board comprised a six layer printed circuit board (PCB) with a total thickness of 0.060". Copper metallization on the two outer layers was limited to pads and traces needed for soldering the converter and peripheral components to the board. The four inner layers comprised power and ground planes of 2 oz. copper. This thermal test board, with the paucity of copper on the outer surfaces, limits heat transfer from the converter to the PCB, thereby providing a worst-case but consistent set of conditions for thermal measurements.

温度評価ボードは厚さ0.060"(1.6mm)厚の6層PCBで作成しています。表面2層の銅箔はコンバータを実装するためのパッドと周辺部品へのパターンのみ限定しています。内側4層は70µmの銅箔で電力、及びグラウンドライン

を形成しています。このように表層の銅箔を限りなく少なくした温度評価ボードは、コンバータからPCBへの熱の逃げを制限し、ワーストケースでありながら矛盾の無い温度評価条件を実現しています。

FDK's custom wind tunnel was used to provide precise horizontal laminar airflow in the range of 50 LFM to 500LFM, at ambient temperatures between 30°C and 85°C. Infrared (IR) thermography and thermocouples were used for temperature measurements. (See Fig. D & Fig. E)

FDKオリジナルの風洞実験装置は水平方向の層流を50LFM(自然対流と同等、NC)から600LFMまで精密に制御でき、環境温度は30°Cから85°Cを制御できます。温度測定には赤外線(IR)サーモグラフィと熱電対を使用しています。(図D、及び図E参照)

It is advisable to check the converter temperature in the actual application, particularly if the application calls for loads close to the maximums specified by the derating curves. IR thermography or thermocouples may be used for this purpose. In the latter case, AWG#40 gauge thermocouples are recommended to minimize interference and measurement error. Optimum locations for placement of thermocouples are indicated in Fig. F.

コンバータの温度を実際の使用環境で測定することをお勧めします。特に実用上の負荷が温度デレーティングの最大値に近い場合は測定が必要です。温度測定には赤外線サーモグラフィ、又は熱電対をお使いいただけます。熱電対を使用する場合、風の妨げになることを防ぐためと、測定誤差を少なくするため、AWG40の熱電対を推奨します。熱電対での測定に最適な箇所は図Fに示します



Fig. D: FDK Original Wind Tunnel

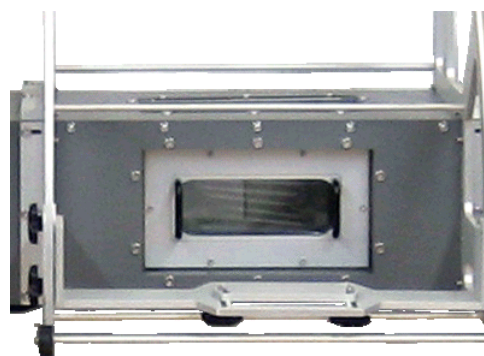

Fig. E: Test Chamber

CW020-SD00

10-14Vdc Input, 30A, 0.8-5.0Vdc Output

Data Sheet

Thermal Derating

Figs *V-1 through Figs *V-7 show the maximum available load current vs. ambient temperature and airflow rates. Ambient temperature was varied between 30°C and 85°C, with airflow rates from NC(50LFM) to 400LFM (0.25m/s to 2.0m/s). The converter was mounted vertically, and the airflow was parallel to the long axis of the converter, going from pin 16 to pin 1.

図 *V-1から図 *V-7は、ある環境温度と風量の条件下における最大出力電流を表します。環境温度は風量NC(50LFM)~400LFMの条件で30°C~85°Cの間を変動させています。コンバータは垂直に設置し、風向きはコンバータの長手方向に平行で16番ピンから1番ピンに向けて吹いています。

- Figs *V-1: Single Operation
- Figs *V-2: Two Parallel Operation (Distance 2.54mm x 4)
- Figs *V-3: Two Parallel Operation (Distance 2.54mm x 6)
- Figs *V-4: Three Parallel Operation (Distance 2.54mm x 4)
- Figs *V-5: Three Parallel Operation (Distance 2.54mm x 6)
- Figs *V-6: Four Parallel Operation (Distance 2.54mm x 4)
- Figs *V-7: Four Parallel Operation (Distance 2.54mm x 6)

- 図 *V-1: シングル動作
- 図 *V-2: 2台パラレル動作 (間隔 2.54mm x 4)
- 図 *V-3: 2台パラレル動作 (間隔 2.54mm x 6)
- 図 *V-4: 3台パラレル動作 (間隔 2.54mm x 4)
- 図 *V-5: 3台パラレル動作 (間隔 2.54mm x 6)
- 図 *V-6: 4台パラレル動作 (間隔 2.54mm x 4)
- 図 *V-7: 4台パラレル動作 (間隔 2.54mm x 6)

The maximum available load current, for any given set of conditions, is defined as the lower of:

- (i) The output current at which the temperature of any component reaches 120°C, or
- (ii) The current rating of the converter (30A)

各々の測定条件で最大出力電流の値は下記のとおり定義します。

- (i) いずれかの部品の温度が120°Cに到達した時点の出力電流値又は
- (ii) コンバータの公称定格電流 (30A)

A maximum component temperature of 120°C should not be exceeded in order to operate within the derating curves. Thus, the temperature at the thermocouple location shown in Fig. F should not exceed 120°C in normal operation.

温度デレーティングの範囲内で動作させるために、部品温度は120°Cを超えないようご注意ください。従って、通常動作時に図Fに示す位置の熱電対の温度が120°Cを超えないようご注意ください。

Thermocouples

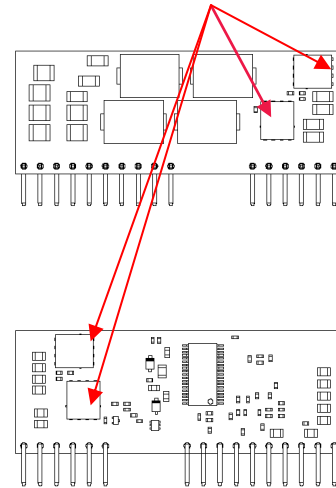

Fig. F: Location of thermocouples for thermal testing

Note that continuous operation beyond the derated current as specified by the derating curves may lead to degradation in performance and reliability of the converter and may result in permanent damage.

出力電流デレーティングカーブで指定された定格電流を超えた連続した操作は、性能の低下、信頼性の低下、及びモジュールの破損を引き起こすことがあります。

Efficiency

Figs *V-8 show efficiency vs. load current at an ambient temperature of 25°C, airflow of 400 LFM (2.0 m/s) with vertical mounting and input voltages of 10V, 12V and 14V.

図 *V-8は環境温度25°C、風量400LFM (2.0m/s)、垂直実装、入力電圧10V、12V、及び14V時における負荷電流と効率のプロットです。

Power dissipation

Figs *V-9 show power dissipation vs. load current at an ambient temperature of 25°C, airflow of 400 LFM (2.0 m/s) with vertical mounting and input voltages of 10V, 12V and 14V.

図 *V-9は環境温度25°C、風量400LFM (2.0m/s)、垂直実装、入力電圧10V、12V、及び14V時における負荷電流と電力消費のプロットです。

Start-up

Figs *V-10 show turn-on output voltage waveforms, using DC input applying, for full rated load currents (resistive load), with external load capacitance.

最大負荷(抵抗負荷)でDC入力ONによる起動時について、外部コンデンサ有りの出力電圧立ち上がり波形を図 *V-10に示します。

CW020-SD00

10-14Vdc Input, 30A, 0.8-5.0Vdc Output

Data Sheet

Output Voltage Ripple

Figs *V-11 show output voltage ripple waveforms for full rated load current (resistive load) with external load capacitance.

The test circuit setup shown in Fig. G was used to obtain the output voltage ripple waveforms. The output voltage ripple waveform was measured across a 1 μ F ceramic capacitor.

最大負荷(抵抗負荷)で外部コンデンサ有りの状態の出力リップルの波形を図 *V-11に示します。

出力リップル波形の観察には図Gに示す試験回路を使用しています。全ての出力リップル波形は1 μ Fのセラミックコンデンサを通して測定しています。

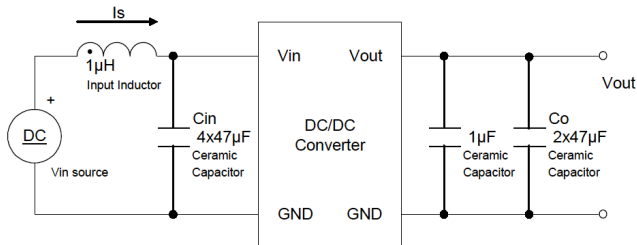

Fig. G: Test Setup for Ripple and Noise

CW020-SD00

10-14Vdc Input, 30A, 0.8-5.0Vdc Output

Data Sheet

Parallel Operation without Phase Shift Control

The parallel option allows for paralleled operation of up to four converters with a load sharing accuracy within +/- 10%. Sch-1 shows the sample input and output connections needed for parallel operation without phase shift control.

パレレルオプションは出力電流の精度±10%の範囲で最大4台まで接続が可能です。Sch-1はフェーズシフト・コントロールを使わない場合の入力、出力の接続方法です。

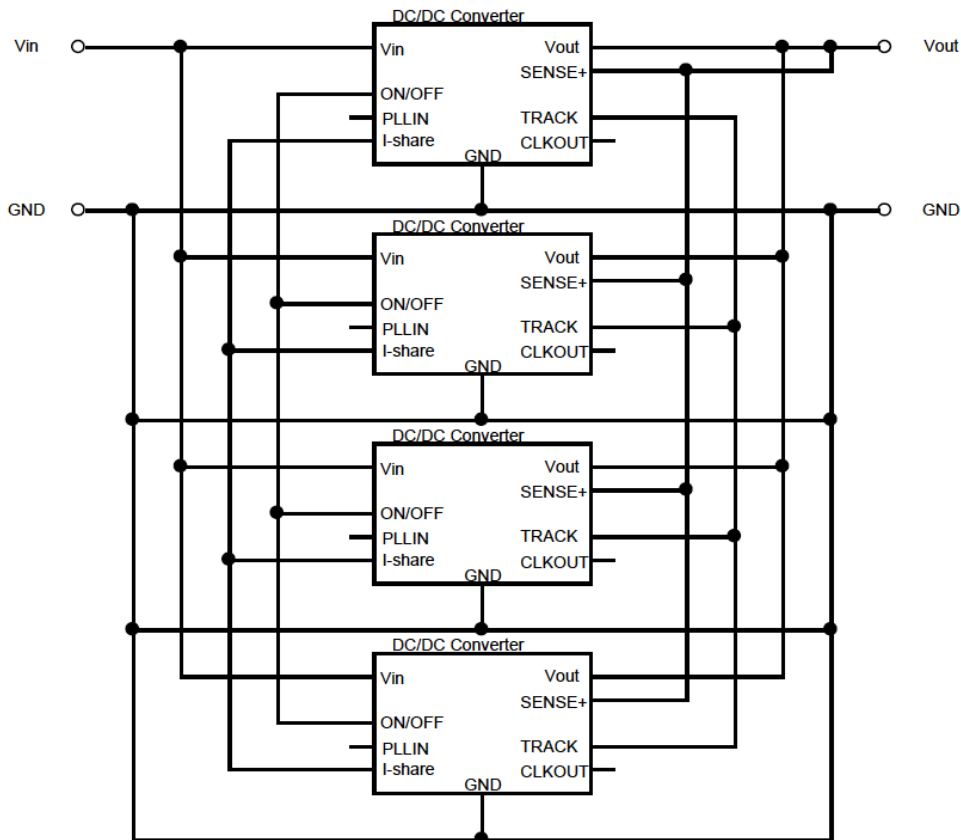

Sch-1: Circuit for using the parallel option

CW020-SD00

10-14Vdc Input, 30A, 0.8-5.0Vdc Output

Data Sheet

Parallel Operation with Phase Shift Control (recommend)

The parallel option allows for paralleled operation of up to four converters with a load sharing accuracy within +/- 10%. Sch-2 shows the sample input and output connections needed for parallel operation with phase shift control.

パラルオプションは出力電流の精度±10%の範囲で最大4台まで接続が可能です。Sch-2はフェーズシフト・コントロールを使う(推奨)場合の入力、出力の接続方法です。

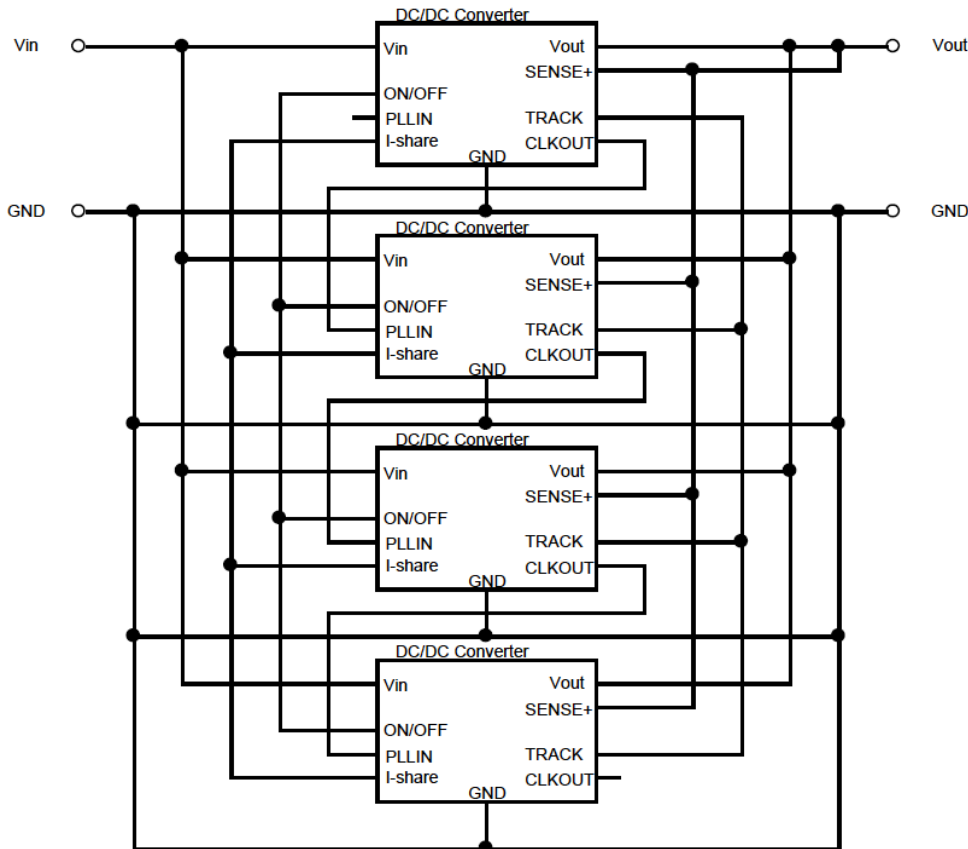

Sch-2: Circuit for using the parallel option

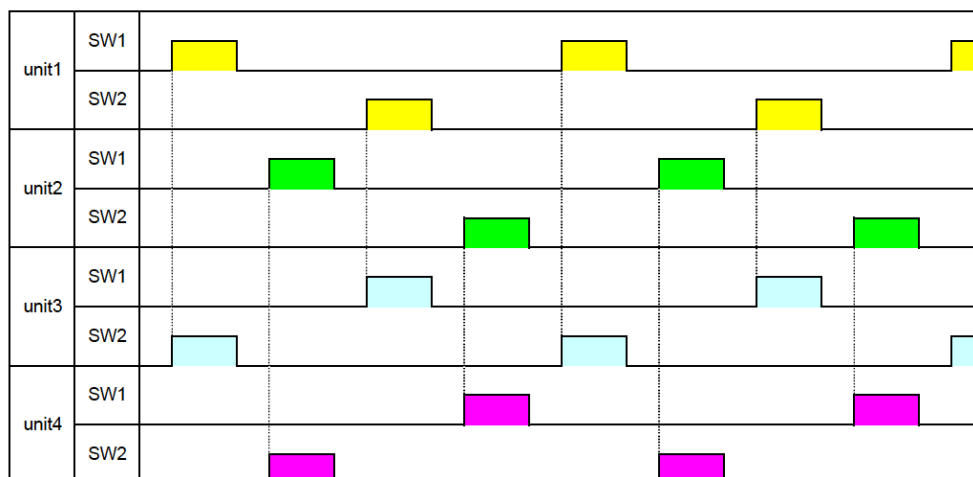

CW020-SD00

Data Sheet

10-14Vdc Input, 30A, 0.8-5.0Vdc Output

Notes on parallel operation

1) PCB trace design

Use the same input source for all converters.
Input lines to the converters should be balanced and as low impedance as possible. Output lines should also be balanced and have low impedance.
External capacitors should be placed as close as possible to the converters.

各コンバータの入力電源は同じ電圧源から接続してください。
入出力端子は電流バランスを取るために均等で低インピーダンスになるように配線してください。
入出力につける外付けコンデンサはできるだけ各コンバータの入出力端子の近くに均等に配置してください。

2) ON/OFF Signal

Timing for start up and shut down using the ON/OFF terminals should be synchronized.

コンバータのON/OFF信号による起動・停止タイミングは、同一になるように回路を構成してください。

3) Current balancing

The accuracy of current sharing is about $\pm 10\%$ when all input and output line impedances are balanced, except light load conditions.
The total output current should be limited to $I_{oMAX} + (I_{oMAX} \times 0.8 \times (N-1))$ during paralleling.

2 in parallel:

$$54A = 30A + (30A \times 0.8 \times (2 \text{ units} - 1))$$

3 in parallel:

$$78A = 30A + (30A \times 0.8 \times (3 \text{ units} - 1))$$

4 in parallel:

$$102A = 30A + (30A \times 0.8 \times (4 \text{ units} - 1))$$

Note that if there are big differences in impedance in the input or output lines, the current balancing can not be maintained within 10%. In this case, the design should be such that the output current from any one converter cannot exceed the maximum rated current.

各出力パターンの等しい条件下では、電流バランスの精度は $\pm 10\%$ 程度です。

並列動作でご使用の場合、総出力電流は $I_{oMAX} + (I_{oMAX} \times 0.8 \times (N-1))$ までに制限してください。

2台で並列動作の場合:

$$54A = 30A + (30A \times 0.8 \times (2 \text{ 台} - 1))$$

3台で並列動作の場合:

$$78A = 30A + (30A \times 0.8 \times (3 \text{ 台} - 1))$$

4台で並列動作の場合:

$$102A = 30A + (30A \times 0.8 \times (4 \text{ 台} - 1))$$

各コンバータの入出力インピーダンスに大きな差がある場合には、電流バランス精度が $\pm 10\%$ を満足できない場合があります。その場合には最大電流を供給しているコンバータが定格電流を超えない条件でご使用ください。

CW020-SD00

10-14Vdc Input, 30A, 0.8-5.0Vdc Output

Data Sheet

Thermal Derating

Single Operation

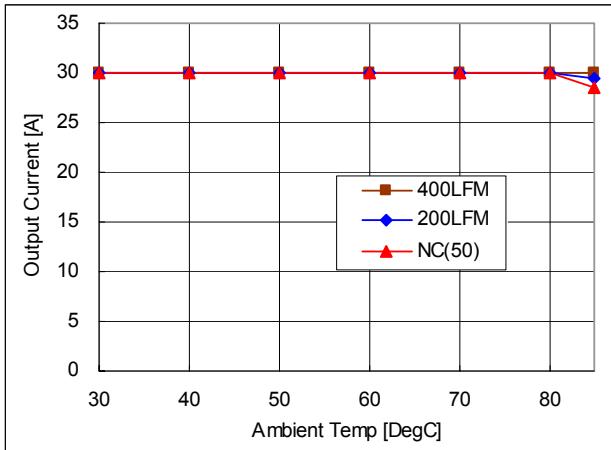

Fig-0.8V-1: Vout=0.8V

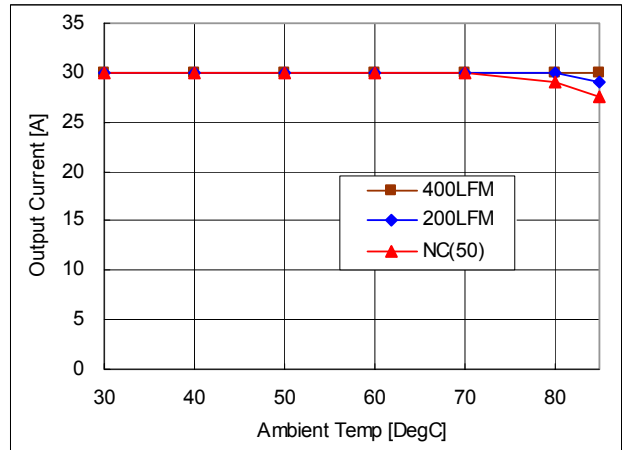

Fig-1.0V-1: Vout=1.0V

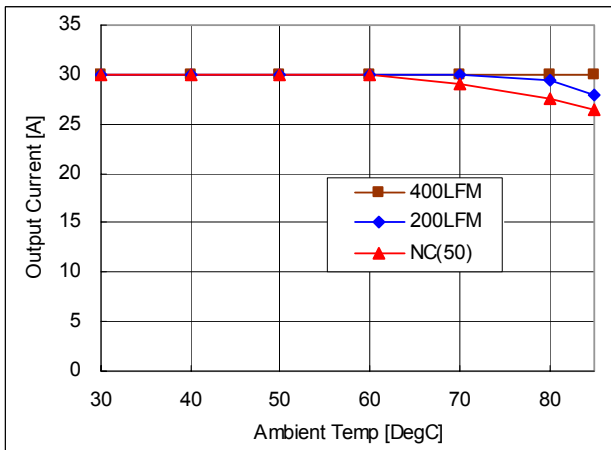

Fig-1.5V-1: Vout=1.5V

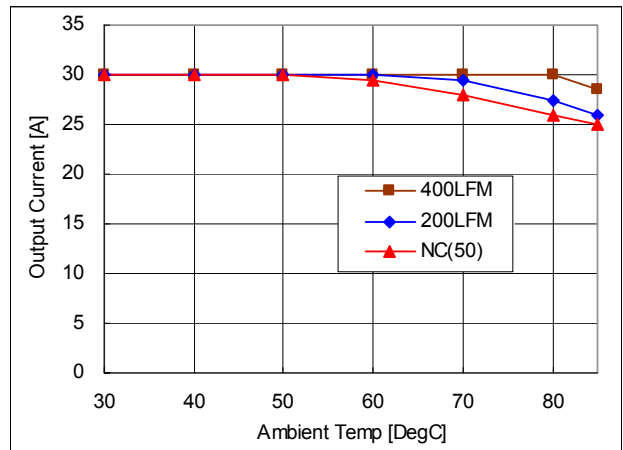

Fig-2.0V-1: Vout=2.0V

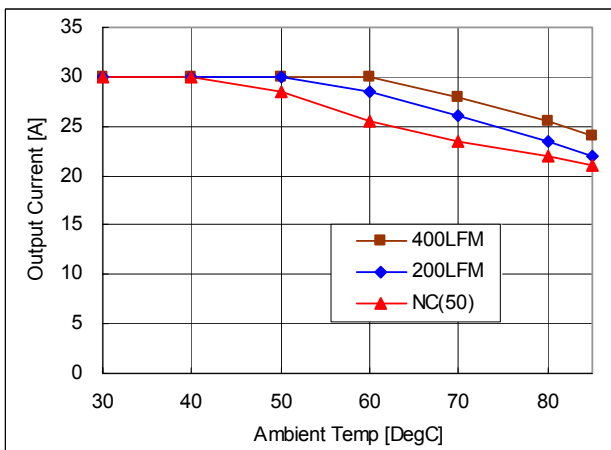

Fig-3.3V-1: Vout=3.3V

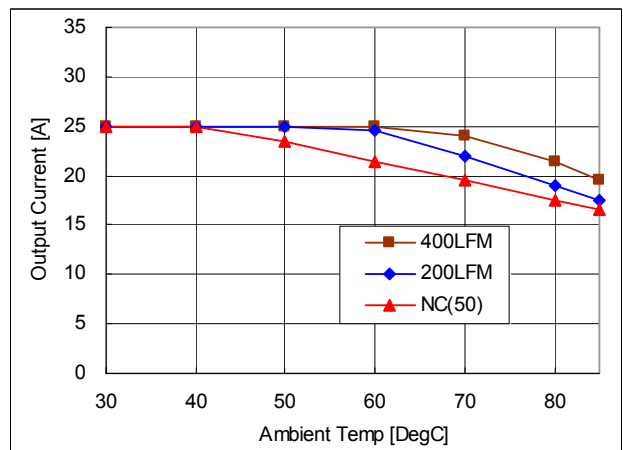

Fig-5.0V-1: Vout=5.0V

CW020-SD00

10-14Vdc Input, 30A, 0.8-5.0Vdc Output

Data Sheet

Two Parallel Operation

Distance 2.54mmX4=10.16mm

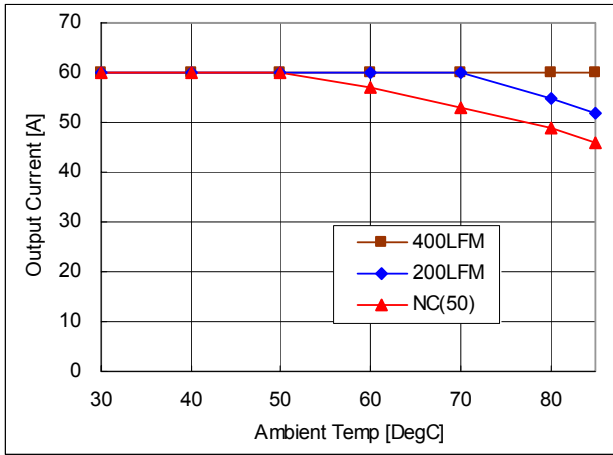

Fig-0.8V-2: Vout=0.8V

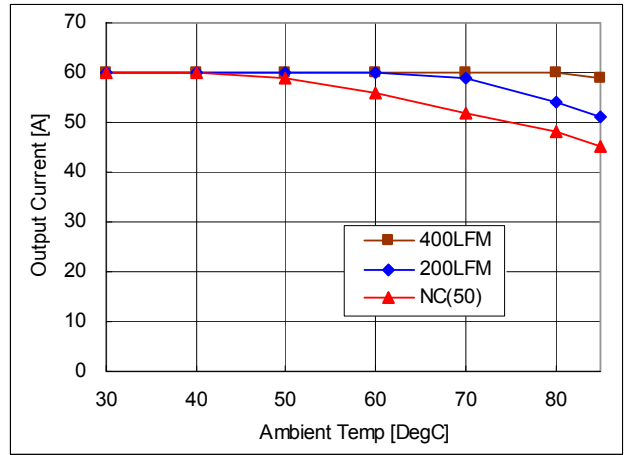

Fig-1.0V-2: Vout=1.0V

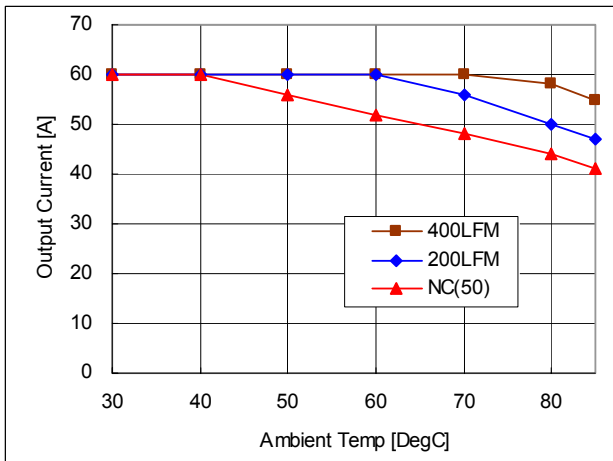

Fig-1.5V-2: Vout=1.5V

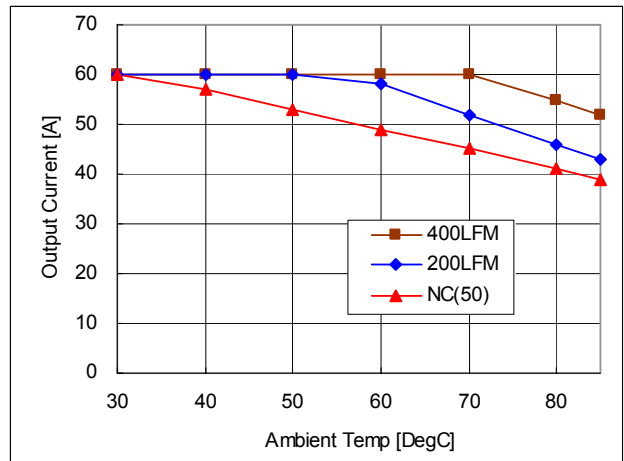

Fig-2.0V-2: Vout=2.0V

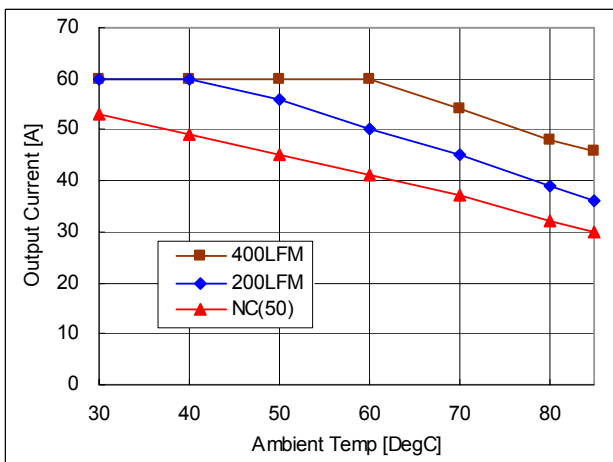

Fig-3.3V-2: Vout=3.3V

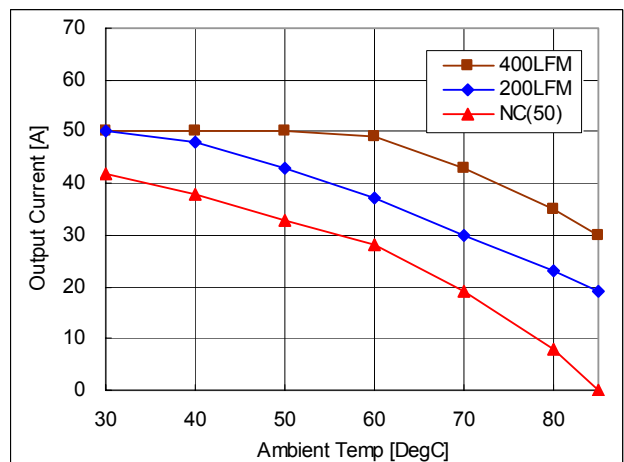

Fig-5.0V-2: Vout=5.0V

CW020-SD00

10-14Vdc Input, 30A, 0.8-5.0Vdc Output

Data Sheet

Two Parallel Operation

Distance 2.54mmX6=15.24mm

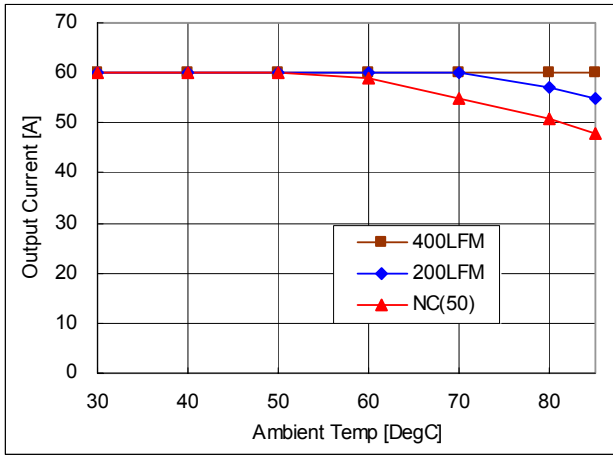

Fig-0.8V-3: Vout=0.8V

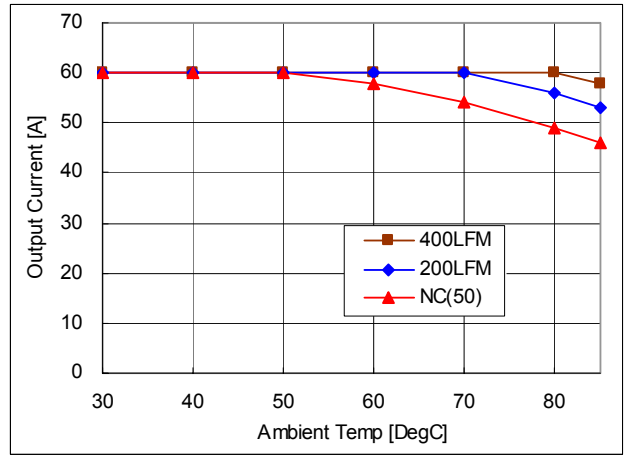

Fig-1.0V-3: Vout=1.0V

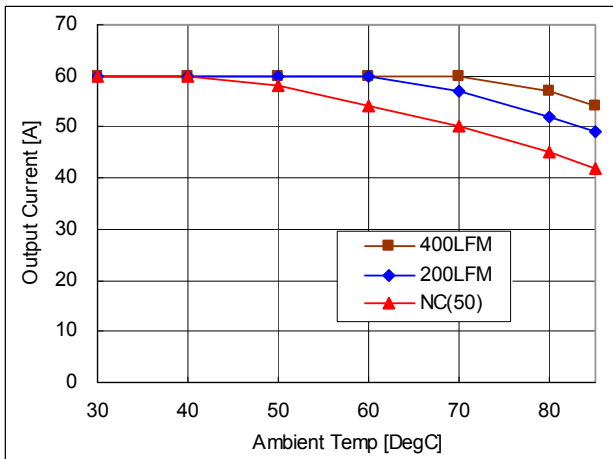

Fig-1.5V-3: Vout=1.5V

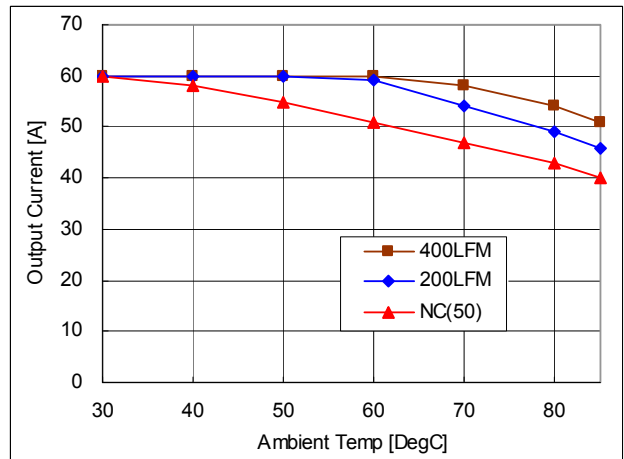

Fig-2.0V-3: Vout=2.0V

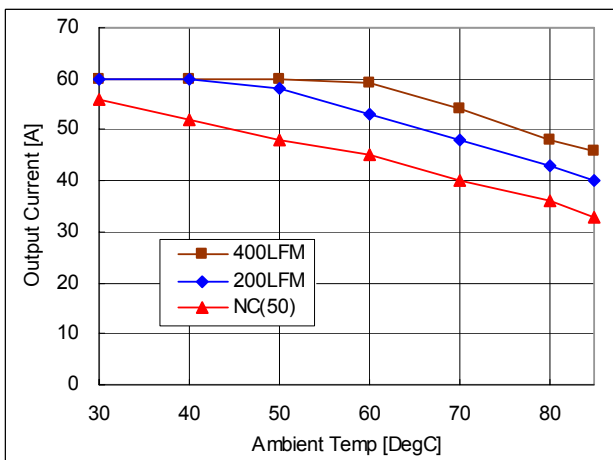

Fig-3.3V-3: Vout=3.3V

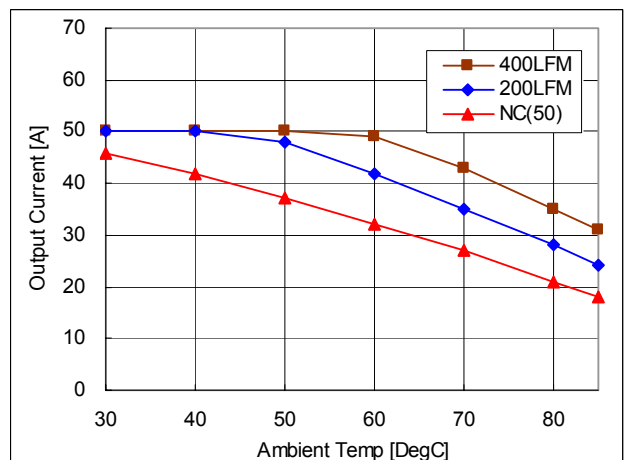

Fig-5.0V-3: Vout=5.0V

CW020-SD00

10-14Vdc Input, 30A, 0.8-5.0Vdc Output

Data Sheet

Three Parallel Operation

Distance 2.54mmX4=10.16mm

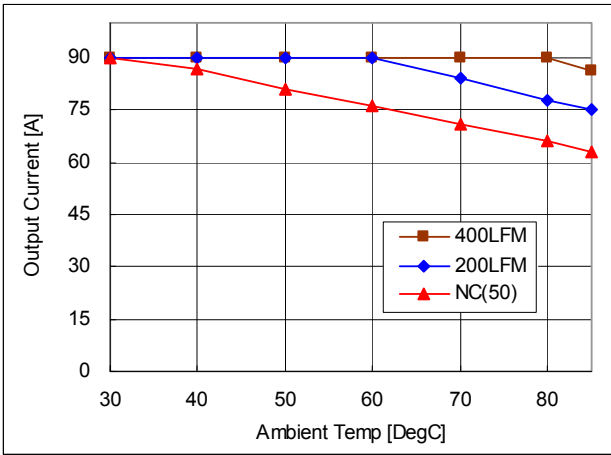

Fig-0.8V-4: Vout=0.8V

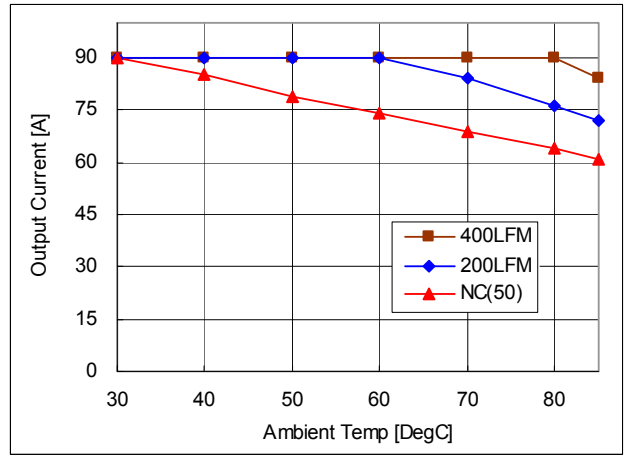

Fig-1.0V-4: Vout=1.0V

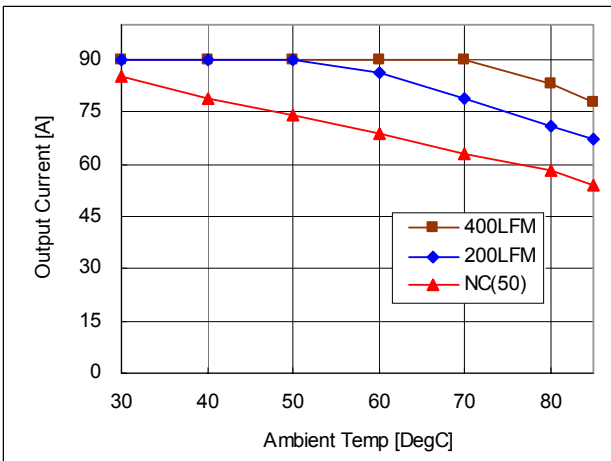

Fig-1.5V-4: Vout=1.5V

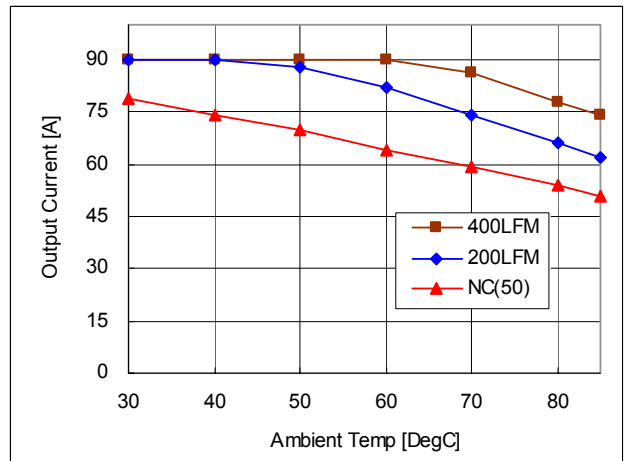

Fig-2.0V-4: Vout=2.0V

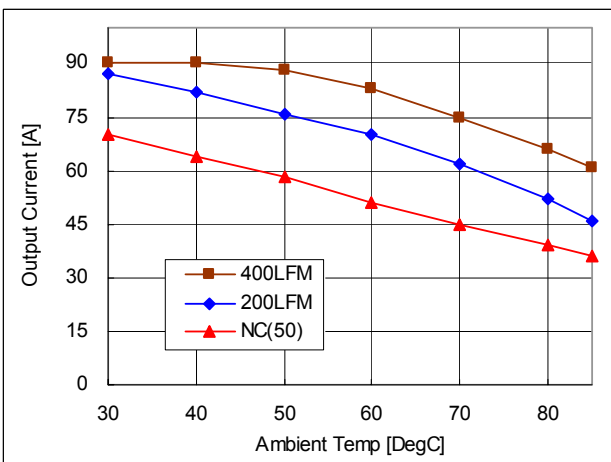

Fig-3.3V-4: Vout=3.3V

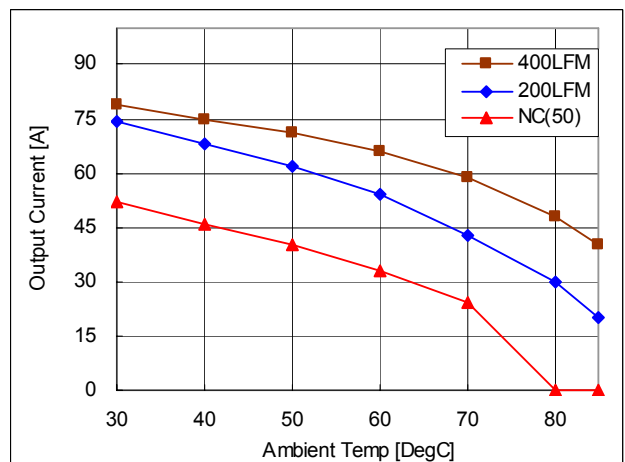

Fig-5.0V-4: Vout=5.0V

CW020-SD00

10-14Vdc Input, 30A, 0.8-5.0Vdc Output

Data Sheet

Three Parallel Operation

Distance 2.54mmX6=15.24mm

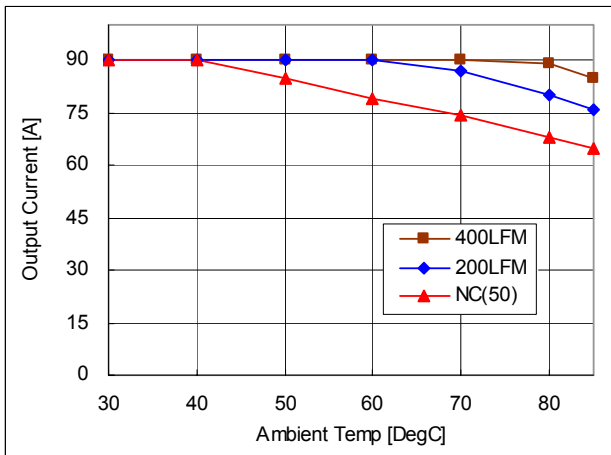

Fig-0.8V-5: Vout=0.8V

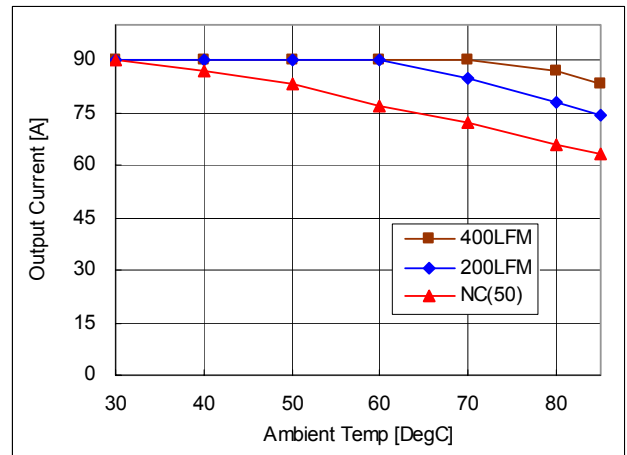

Fig-1.0V-5: Vout=1.0V

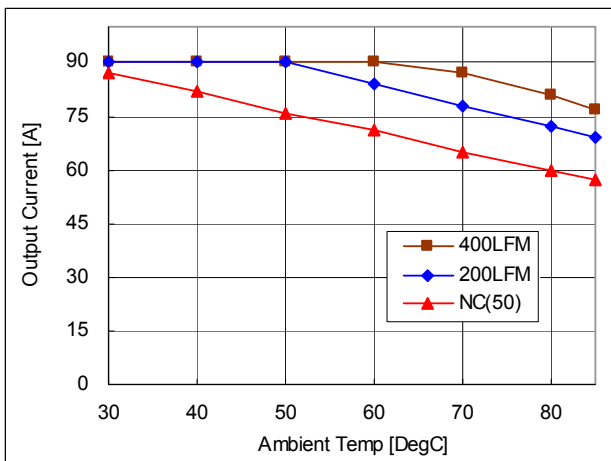

Fig-1.5V-5: Vout=1.5V

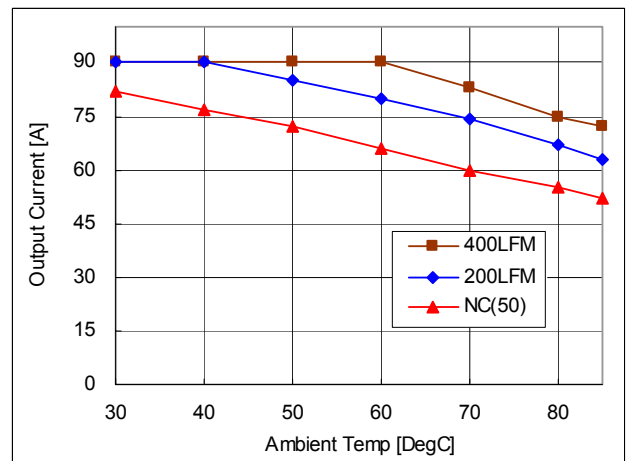

Fig-2.0V-5: Vout=2.0V

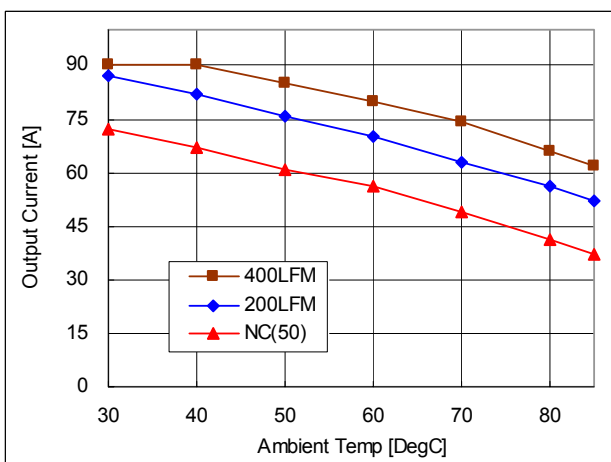

Fig-3.3V-5: Vout=3.3V

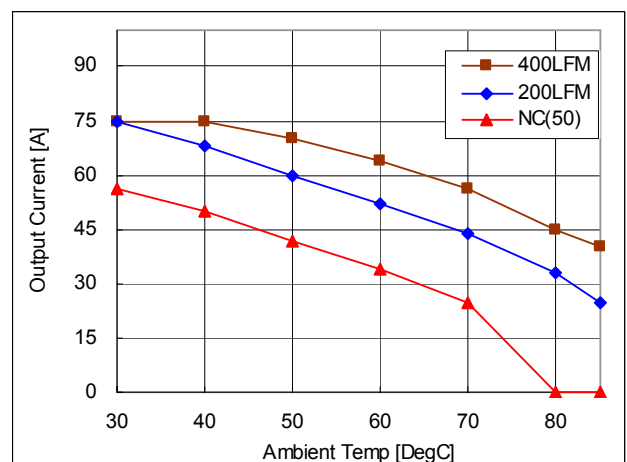

Fig-5.0V-5: Vout=5.0V

CW020-SD00

10-14Vdc Input, 30A, 0.8-5.0Vdc Output

Data Sheet

Four Parallel Operation

Distance 2.54mmX4=10.16mm

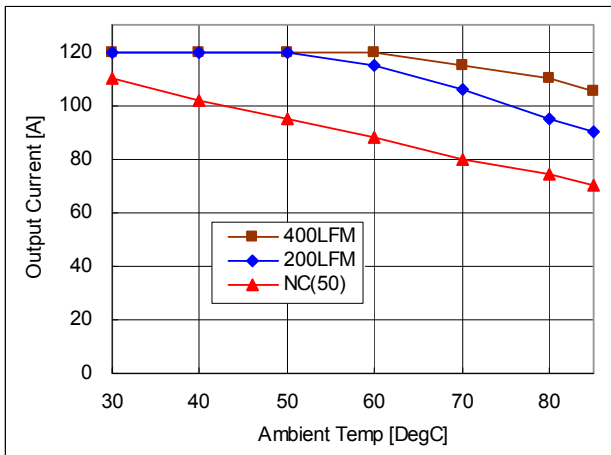

Fig-0.8V-6: Vout=0.8V

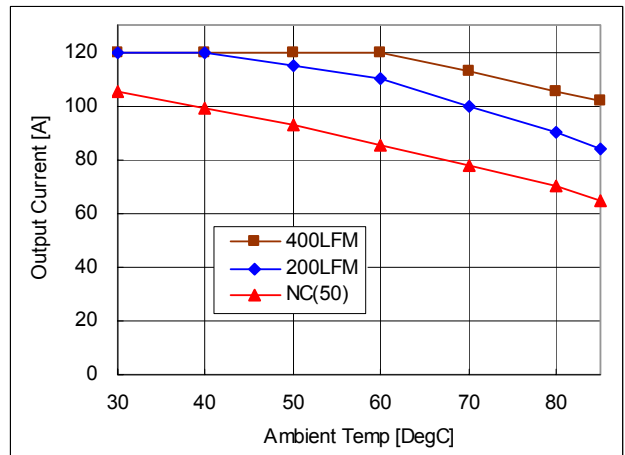

Fig-1.0V-6: Vout=1.0V

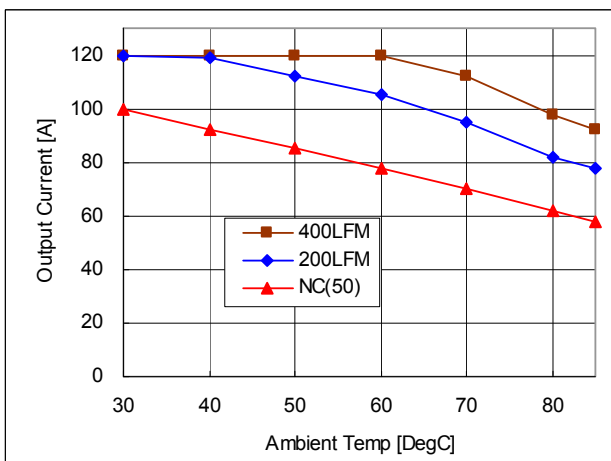

Fig-1.5V-6: Vout=1.5V

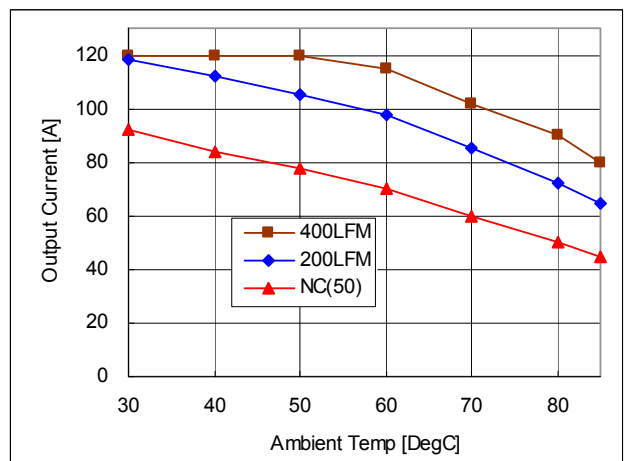

Fig-2.0V-6: Vout=2.0V

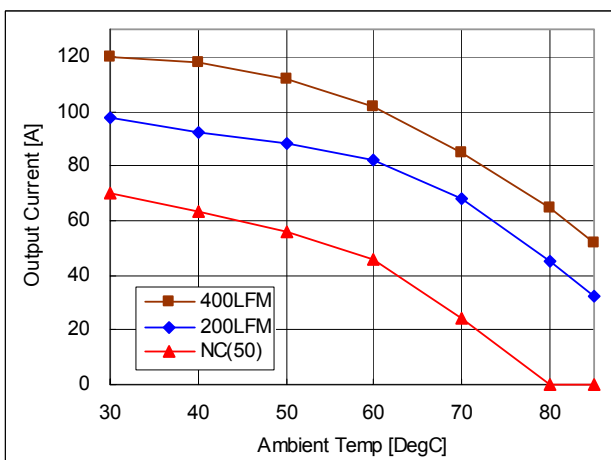

Fig-3.3V-6: Vout=3.3V

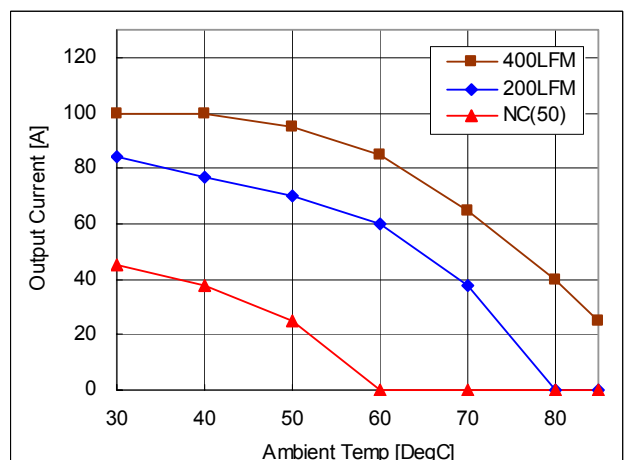

Fig-5.0V-6: Vout=5.0V

CW020-SD00

10-14Vdc Input, 30A, 0.8-5.0Vdc Output

Data Sheet

Four Parallel Operation

Distance 2.54mmX6=15.24mm

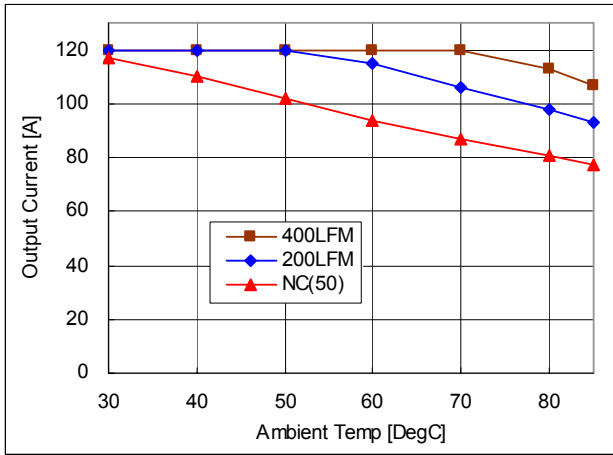

Fig-0.8V-7: Vout=0.8V

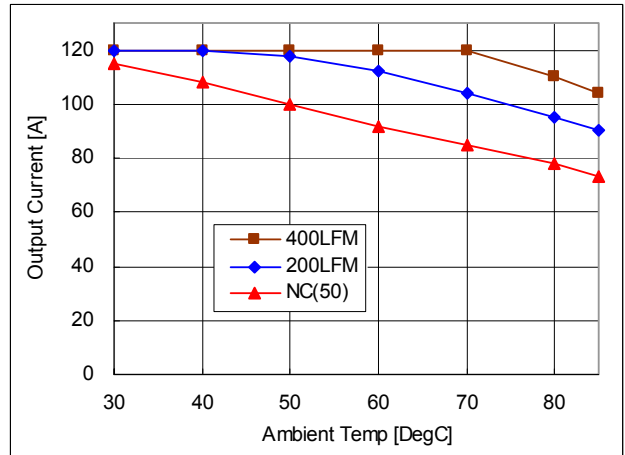

Fig-1.0V-7: Vout=1.0V

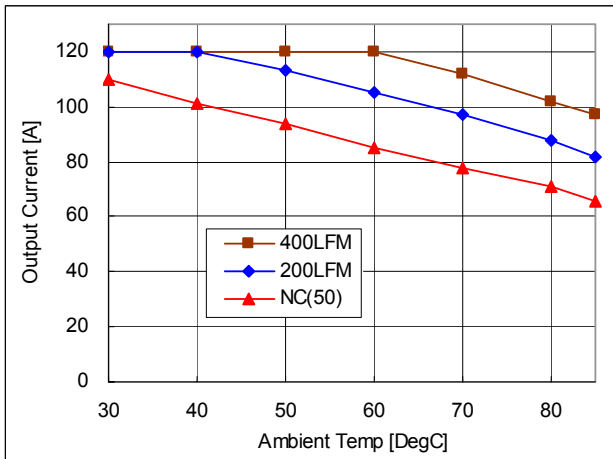

Fig-1.5V-7: Vout=1.5V

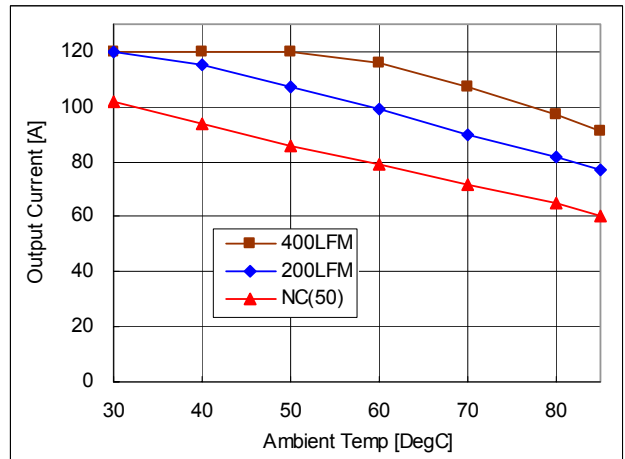

Fig-2.0V-7: Vout=2.0V

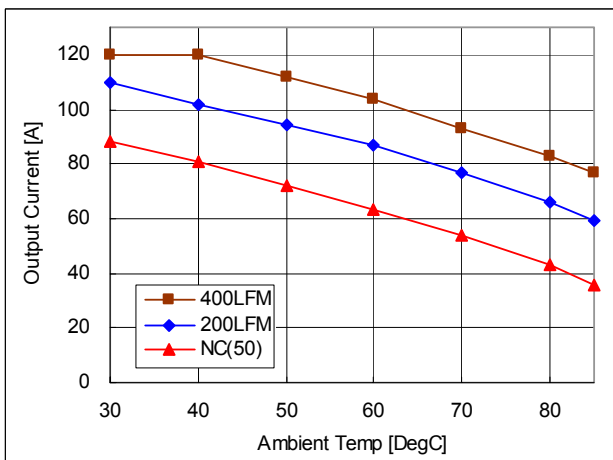

Fig-3.3V-7: Vout=3.3V

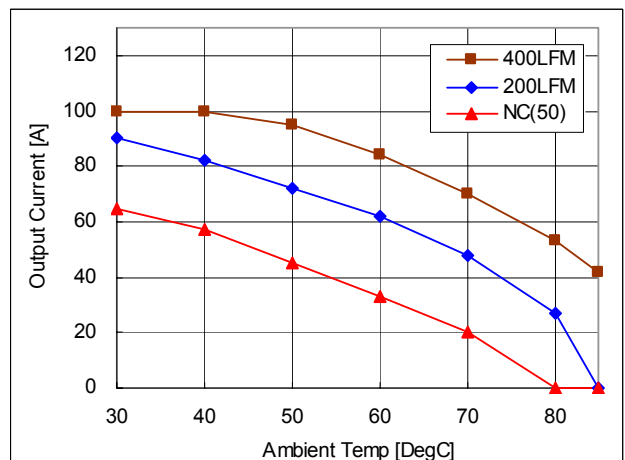

Fig-5.0V-7: Vout=5.0V

CW020-SD00

10-14Vdc Input, 30A, 0.8-5.0Vdc Output

Data Sheet

Efficiency (vs. Output current) Ta=25degC

Single Operation

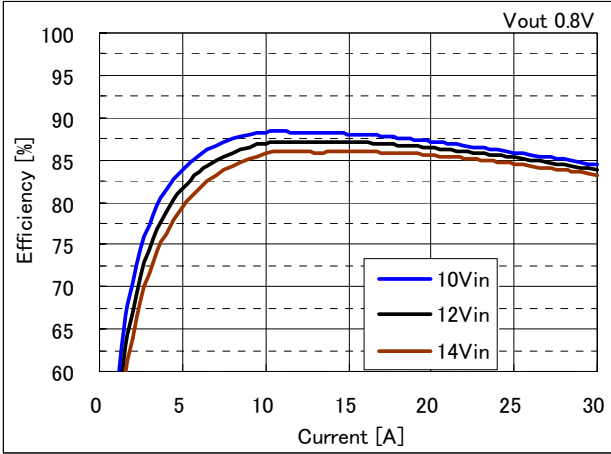

Fig-0.8V-8: Vout=0.8V

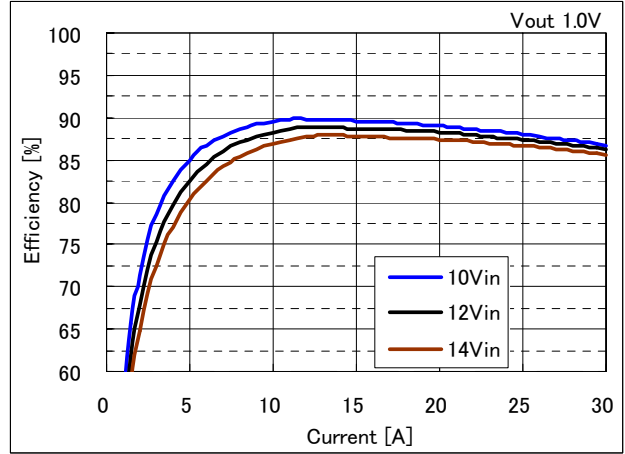

Fig-1.0V-8: Vout=1.0V

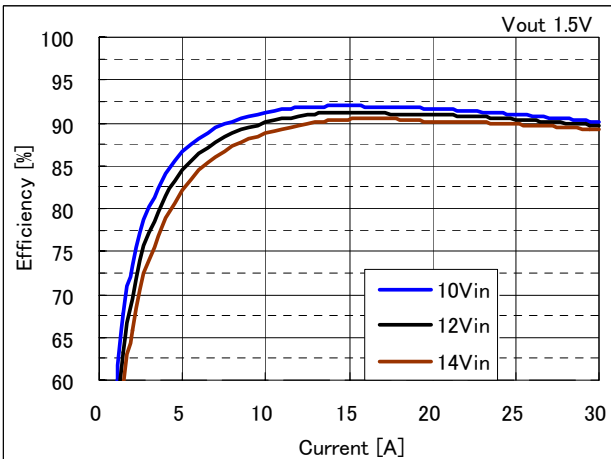

Fig-1.5V-8: Vout=1.5V

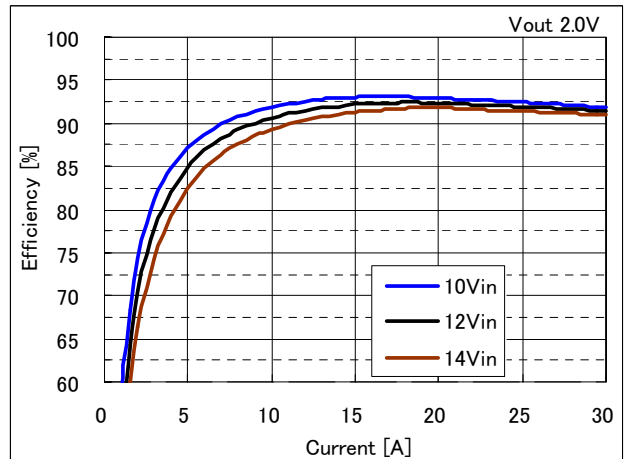

Fig-2.0V-8: Vout=2.0V

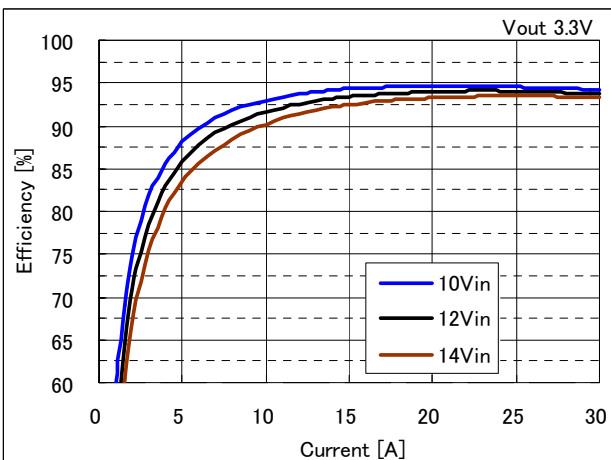

Fig-3.3V-8: Vout=3.3V

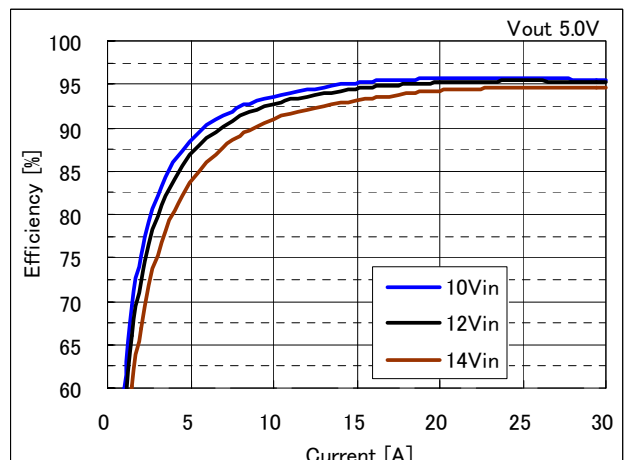

Fig-5.0V-8: Vout=5.0V

CW020-SD00

Data Sheet

10-14Vdc Input, 30A, 0.8-5.0Vdc Output

Power Dissipation (Power Loss vs Output Current)

Single Operation

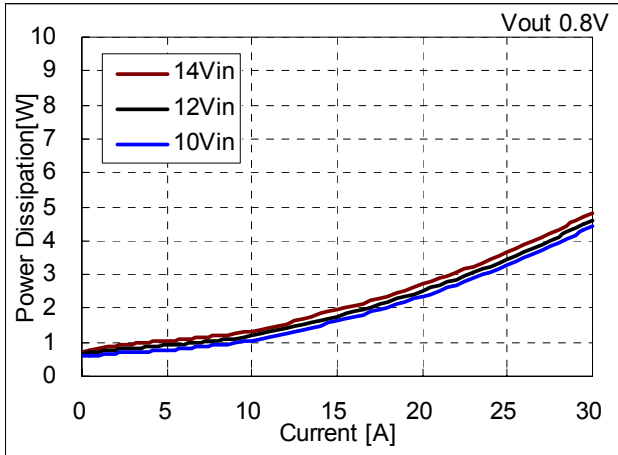

Fig-0.8V-9: Vout=0.8V

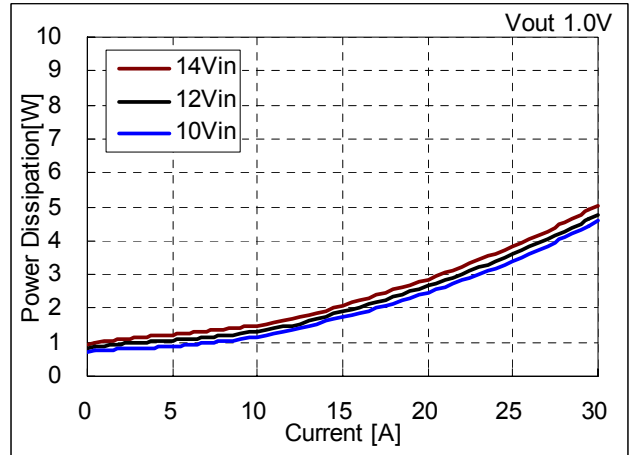

Fig-1.0V-9: Vout=1.0V

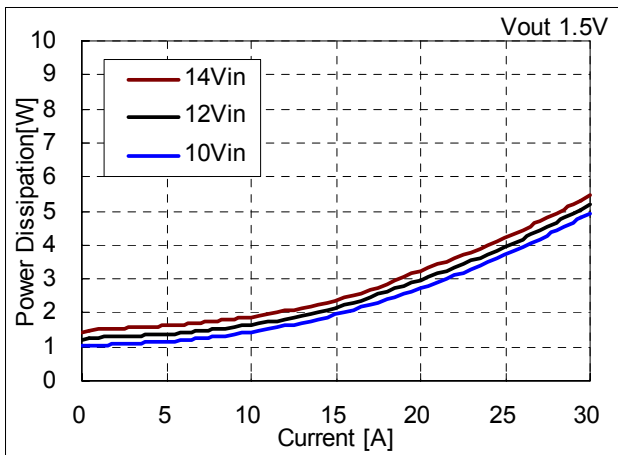

Fig-1.5V-9: Vout=1.5V

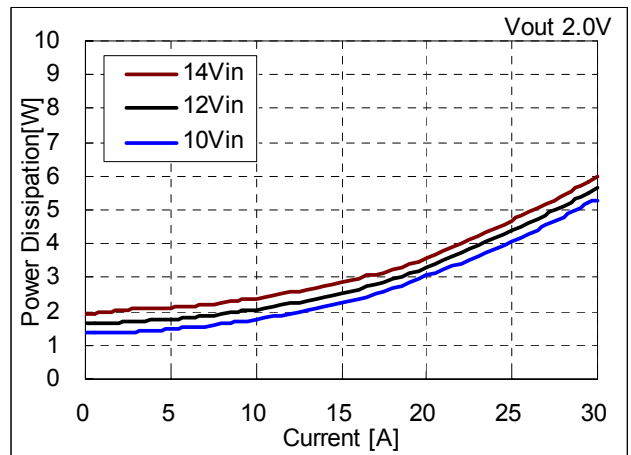

Fig-2.0V-9: Vout=2.0V

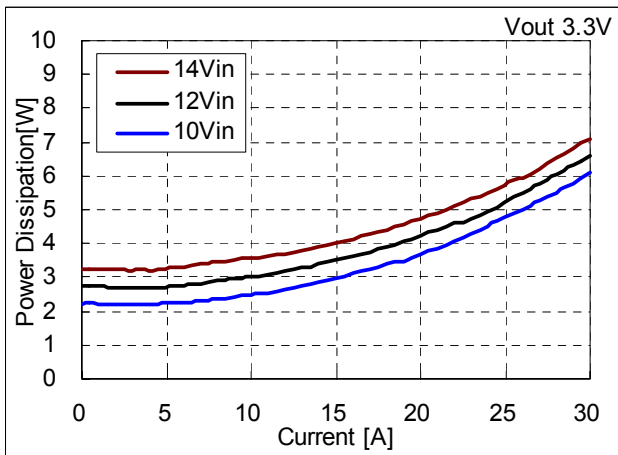

Fig-3.3V-9: Vout=3.3V

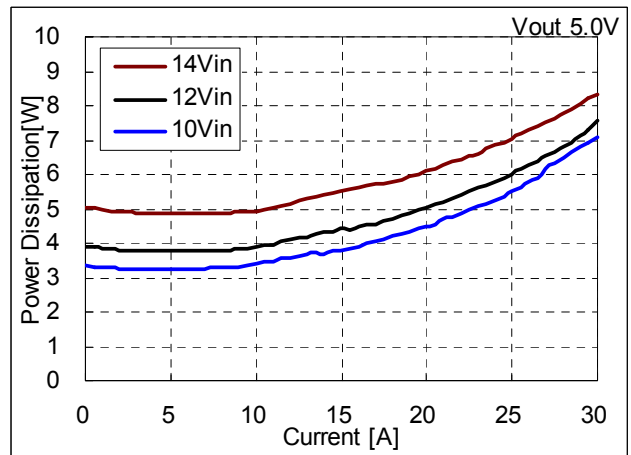

Fig-5.0V-9: Vout=5.0V

CW020-SD00

Data Sheet

10-14Vdc Input, 30A, 0.8-5.0Vdc Output

Start-Up

Single Operation

Turn-on transient for Vout with application of Vin at full rated load current (resistive) and 47uF \times 2 external capacitance at Vin=12V.

Top trace: Vin (10V/div.)

Bottom trace: output voltage (1V/div.)

Time scale: 2 ms/div.

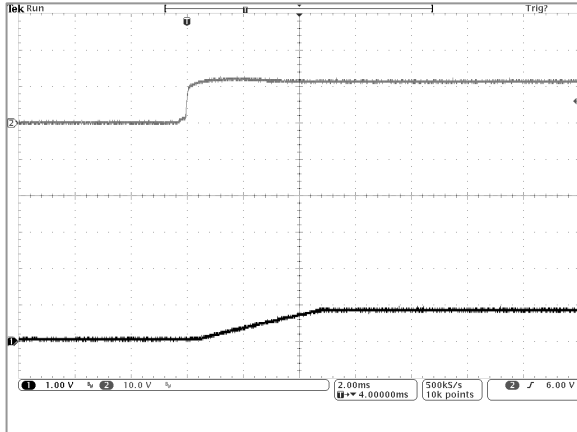

Fig-0.8V-10: Vout=0.8V

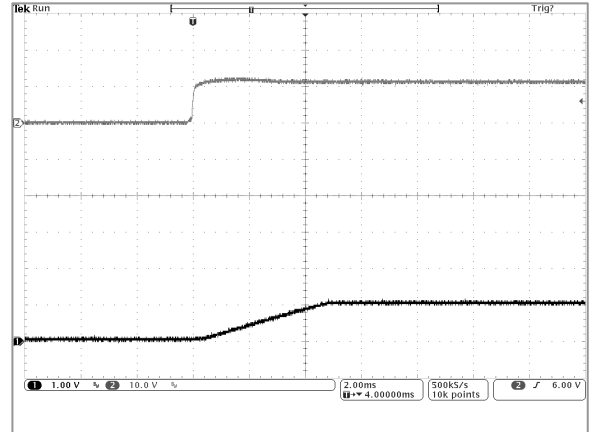

Fig-1.0V-10: Vout=1.0V

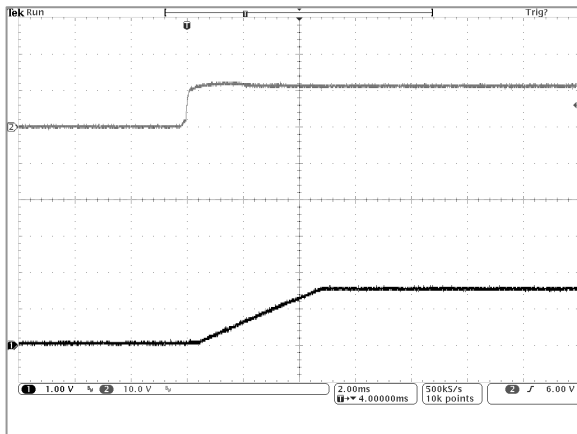

Fig-1.5V-10: Vout=1.5V

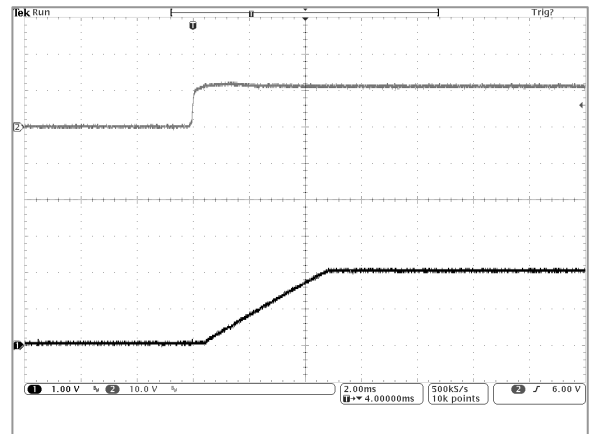

Fig-2.0V-10: Vout=2.0V

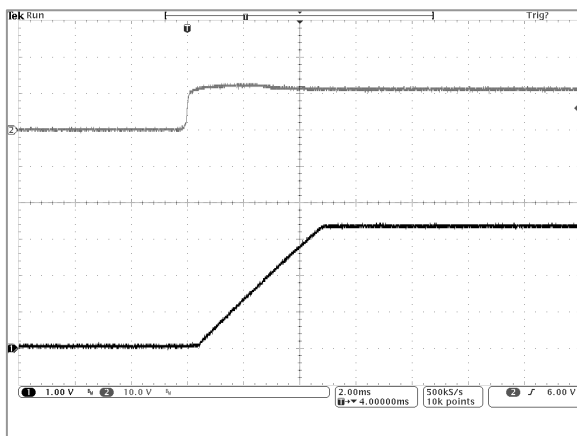

Fig-3.3V-10: Vout=3.3V

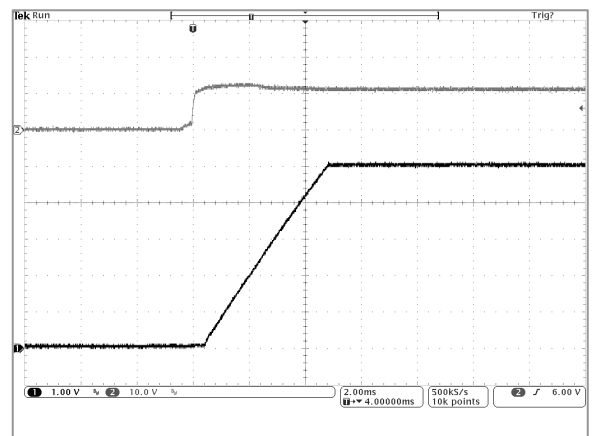

Fig-5.0V-10: Vout=5.0V

CW020-SD00

Data Sheet

10-14Vdc Input, 30A, 0.8-5.0Vdc Output

Ripple and Noise

Single Operation

Output voltage ripple (20mV/div.) for Vout at full rated load current into a resistive load with external capacitance 47uF_{x2} ceramic + 1uF ceramic at Vin=12V. Time scale: 2us/div

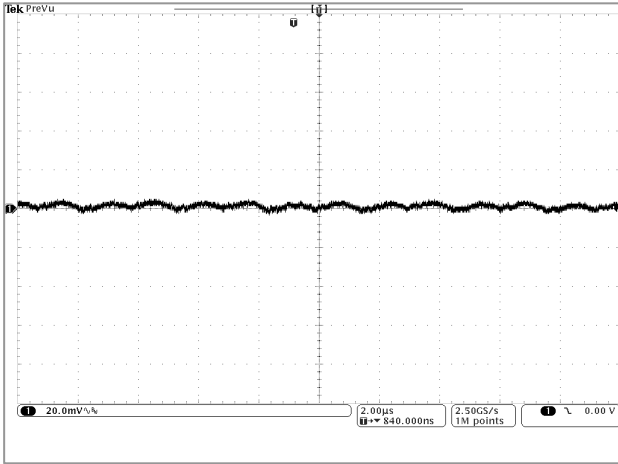

Fig-0.8V-11: Vout=0.8V

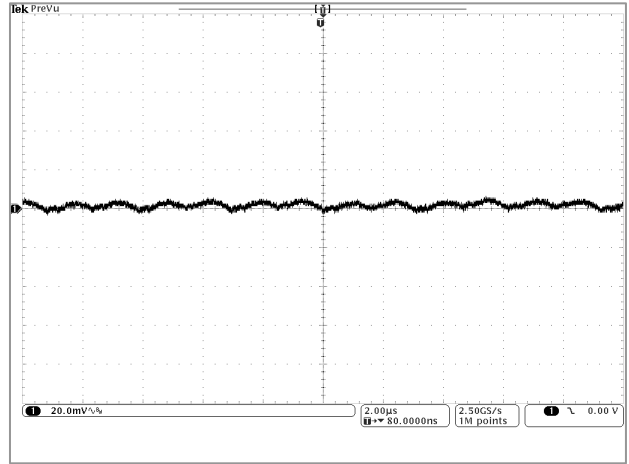

Fig-1.0V-11: Vout=1.0V

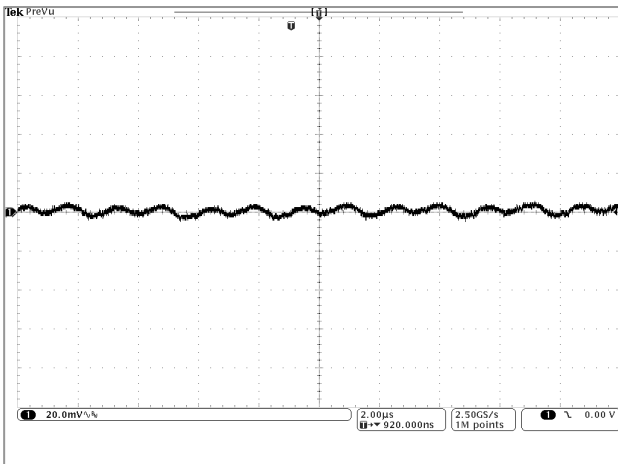

Fig-1.5V-11: Vout=1.5V

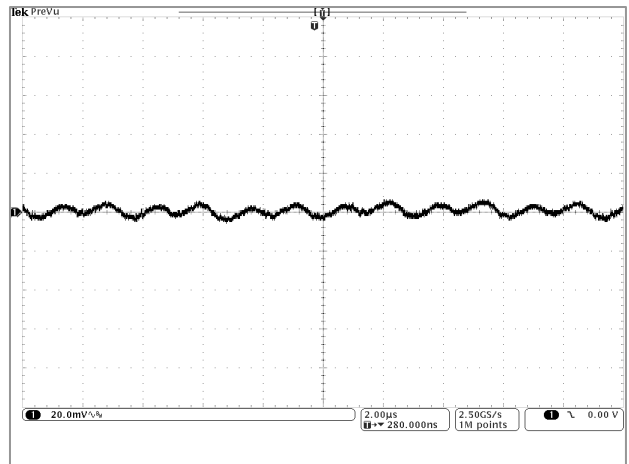

Fig-2.0V-11: Vout=2.0V

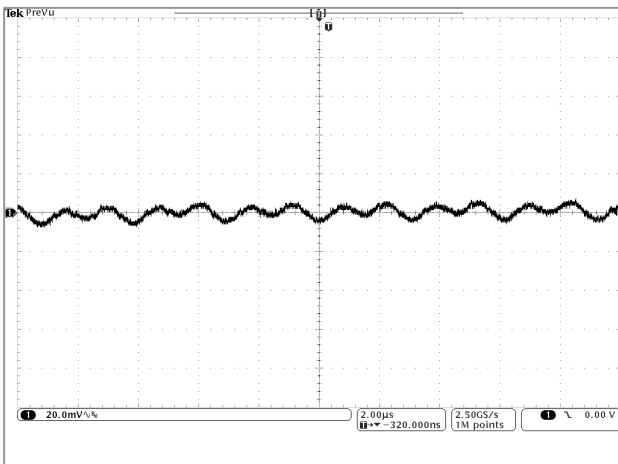

Fig-3.3V-11: Vout=3.3V

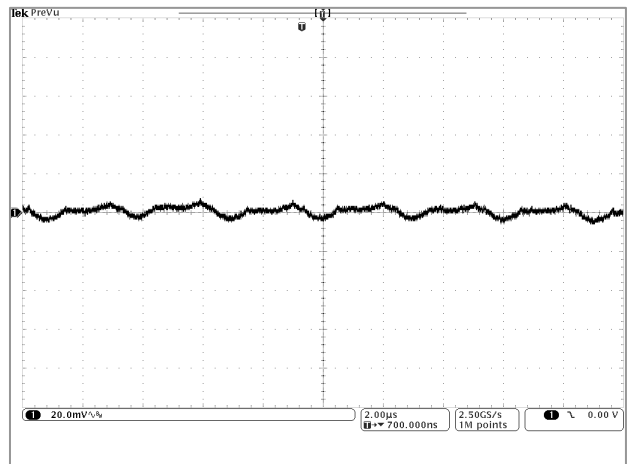

Fig-5.0V-11: Vout=5.0V

CW020-SD00

Data Sheet

10-14Vdc Input, 30A, 0.8-5.0Vdc Output

Load Step Response

Output voltage response for Vout to positive load current step change between 15A(5V:12.5A) and 30A(5V:25A) with slew rate of +/- 5A/us at Vin=12V. Co=47uFx2 ceramic

Top trace: output voltage (100mV/div.)

Bottom trace: load current (10A/div.) Time scale: 20us/div.

Time scale: 20us/div.

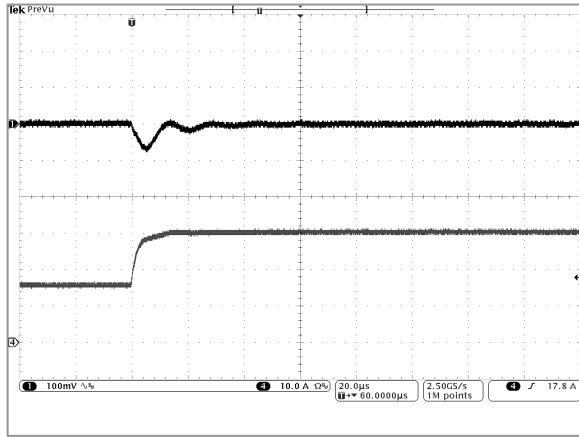

Fig-0.8V-12_Rise: Vout=0.8V

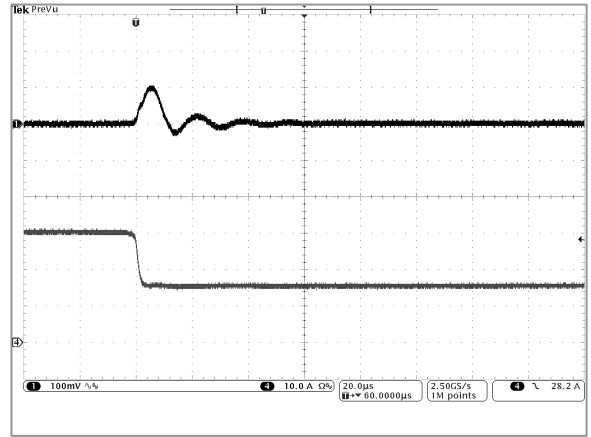

Fig-0.8V-12_Fall: Vout=0.8V

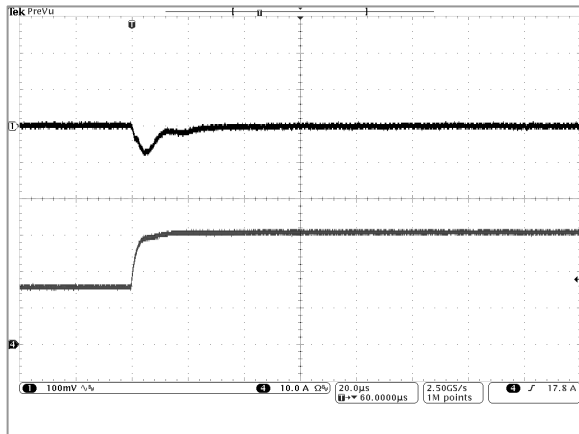

Fig-1.0V-12_Rise: Vout=1.0V

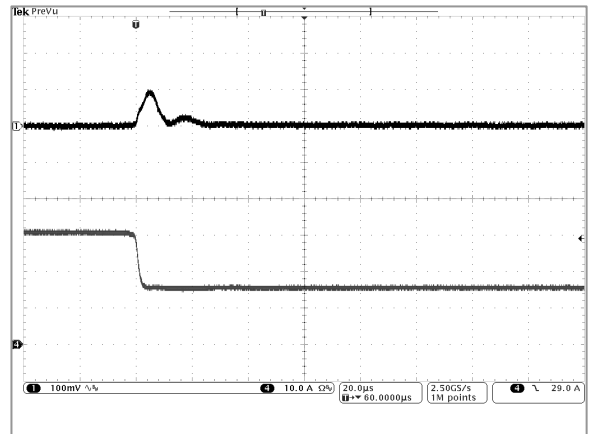

Fig-1.0V-12_Fall: Vout=1.0V

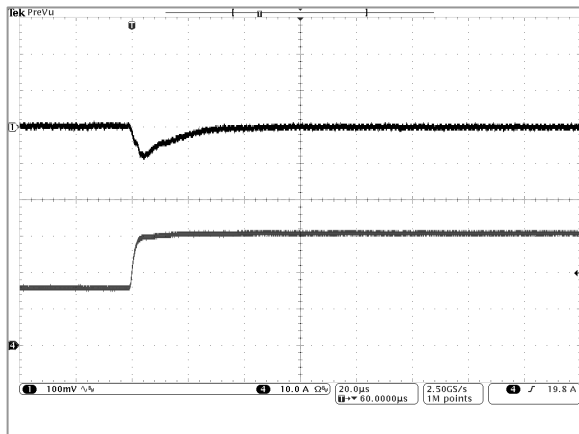

Fig-1.5V-12_Rise: Vout=1.5V

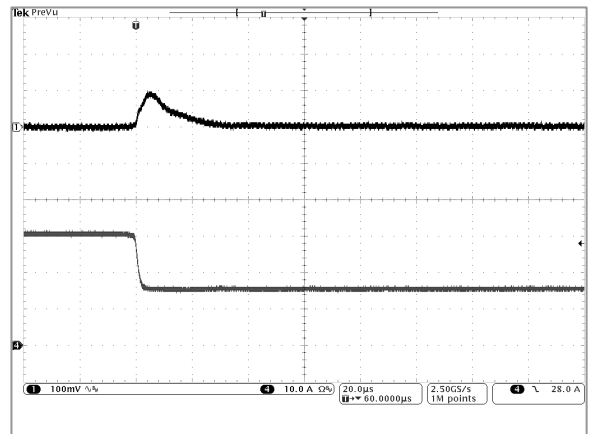

Fig-1.5V-12_Fall: Vout=1.5V

CW020-SD00

Data Sheet

10-14Vdc Input, 30A, 0.8-5.0Vdc Output

Load Step Response (Continued)

Output voltage response for Vout to positive load current step change between 15A(5V:12.5A) and 30A(5V:25A) with slew rate of +/- 5A/us at Vin=12V. Co=47uFx2 ceramic

Top trace: output voltage (100mV/div.)

Bottom trace: load current (10A/div.) Time scale: 20us/div.

Time scale: 20us/div.

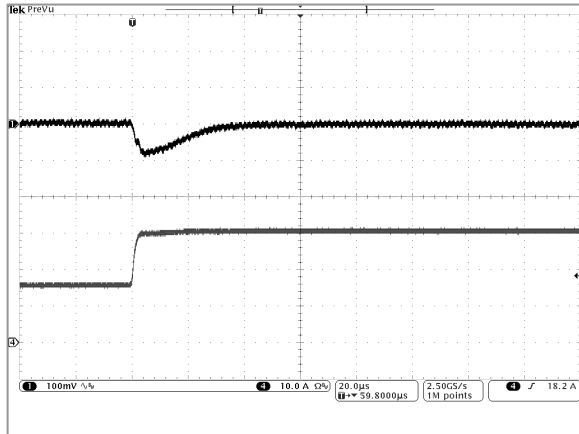

Fig-2.0V-12_Rise: Vout=2.0V

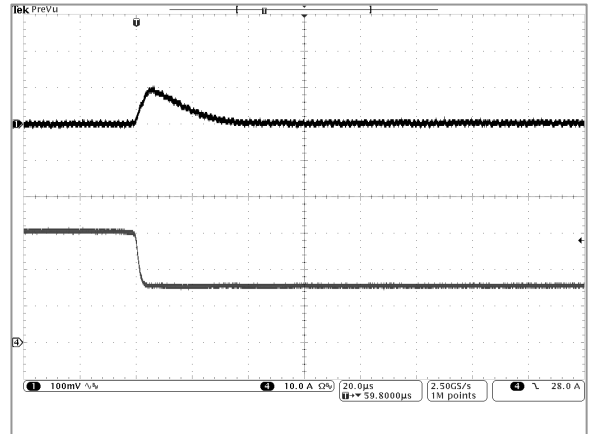

Fig-2.0V-12_Fall: Vout=2.0V

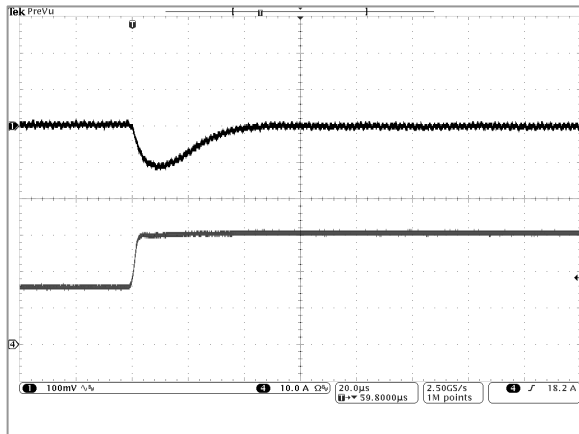

Fig-3.3V-12_Rise: Vout=3.3V

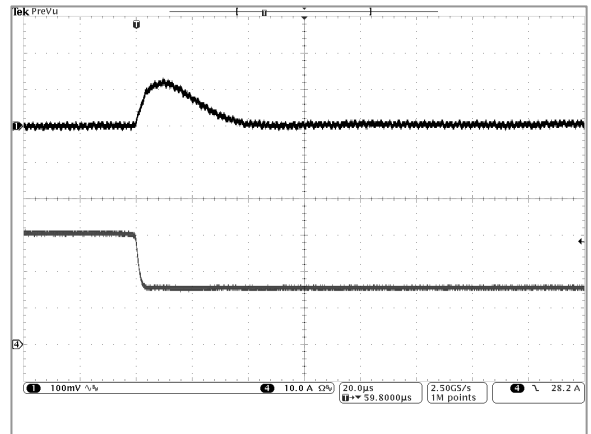

Fig-3.3V-12_Fall: Vout=3.3V

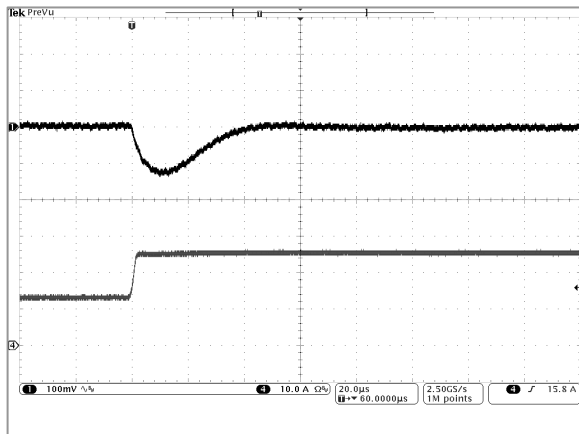

Fig-5.0V-12_Rise: Vout=5.0V

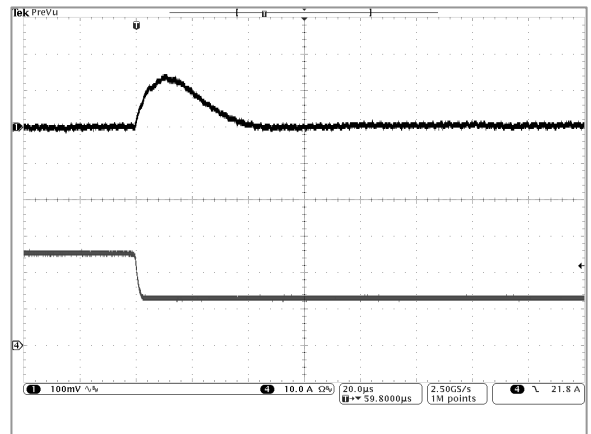

Fig-5.0V-12_Fall: Vout=5.0V

CW020-SD00

Data Sheet

10-14Vdc Input, 30A, 0.8-5.0Vdc Output

Ambient Specification

PARAMETER	NOTES	
Temperature	Operating	Ta:0~85degC
	Non Operating	Tstg:-40~125degC
Humidity	Operating	5~95 %RH (Non-condensation)
	Non Operating	5~95%RH (Non-condensation)
Cooling		(See attached thermal derating curves)
Shock	Operating	15 G's for 11 mS duration half sine waveform 3 shocks per face
	Non Operating	50 G's for 11 mS duration half sine waveform 3 shocks per face
Vibration	Operating	Frequency Range: 5 to 100 to 5 Hz Magnitude: 1.0 G's sinusoidal peak Sweep Rate: 0.25 octave per minute
	Non Operating	Frequency Range: 5 to 500 to 5 Hz Magnitude: 3.0 G's sinusoidal peak Sweep Rate: 0.25 octave per minute
Weight		12g typ.

CW020-SD00

10-14Vdc Input, 30A, 0.8-5.0Vdc Output

Data Sheet

Mechanical Drawing

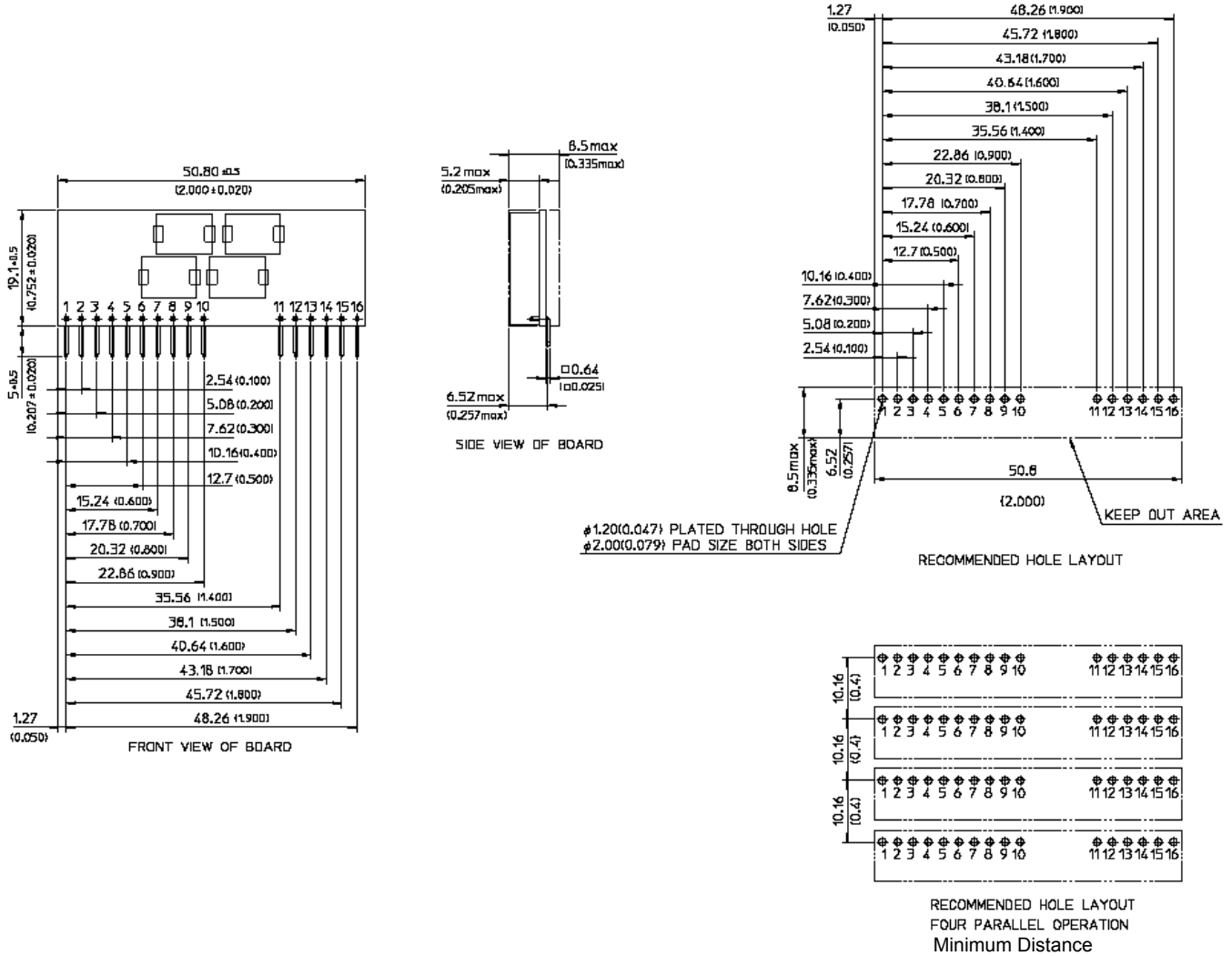

Pin Connections			
Pin #	Function	Pin #	Function
1	Vout (+)	9	PLLIN
2	Vout (+)	10	CLKOUT
3	Sense (+)	11	GND
4	Vout (+)	12	Vin (+)
5	GND	13	Vin (+)
6	GND	14	ON/OFF
7	TRIM	15	Track
8	I-Share	16	Power Good

CW020-SD00

Data Sheet

10-14Vdc Input, 30A, 0.8-5.0Vdc Output

Cautions

NUCLEAR AND MEDICAL APPLICATIONS: FDK Corporation products are not authorized for use as critical components in life support systems, equipment used in hazardous environments, or nuclear control systems without the written consent of FDK Corporation.

SPECIFICATION CHANGES AND REVISIONS: Specifications are version-controlled, but are subject to change without notice.