

Data sheet | Item number: 286-792

Optocoupler module; Red status indicator; gray

[www.wago.com/286-792](http://www.wago.com/286-792)

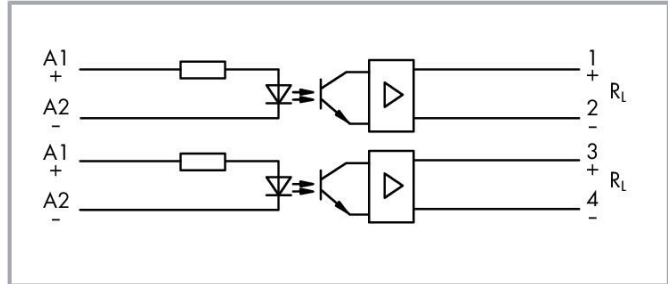
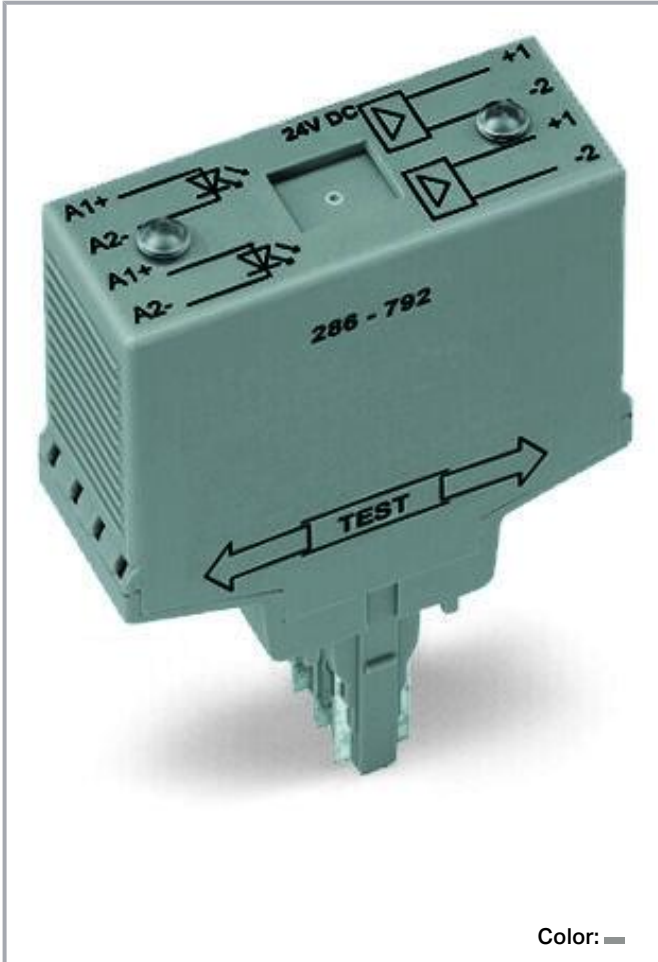

Subject to changes. Please also observe the further product documentation!

WAGO GmbH & Co. KG  
Hansastr. 27  
32423 Minden  
Phone: +49571 887-0 | Fax: +49571 887-169  
Email: [info.de@wago.com](mailto:info.de@wago.com) | Web: [www.wago.com](http://www.wago.com)

Do you have any questions about our products?  
We are always happy to take your call at +49 (571) 887-44222.

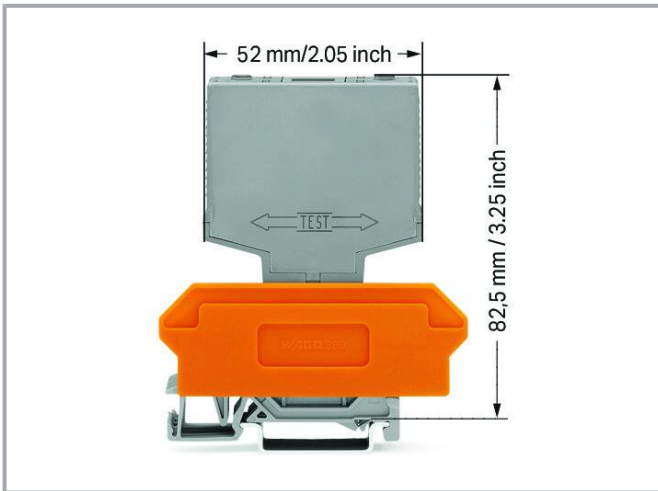

## Data

### Technical data

#### Control Circuit

Nominal input voltage $U_N$	DC 24 V
Input voltage range (high level)	DC 7.5 ... 30 V
Nominal input current at $U_N$	15 mA

#### Load circuit

Circuit type	2-way 2-wire connection
Limiting continuous current	0.25 A
Nominal output voltage	DC 24 V
Output voltage range	DC 20 ... 30 V
Voltage drop at output (max.)	$\leq$ DC 2.5 V
Leakage current at rated voltage	$\leq$ 3 $\mu$ A
Turn-on time	$\leq$ 60 $\mu$ s
Turn-off time	$\leq$ 120 $\mu$ s
Switching frequency	$\leq$ 1.5 kHz

#### Safety and protection

Pollution degree	2
Dielectric strength (control/load circuit) (AC, 1 min)	2.5 kVrms

Subject to changes. Please also observe the further product documentation!



Protection type	IP20
-----------------	------

### Physical data

Width	20 mm / 0.787 inches
Height from upper-edge of DIN-rail	82.5 mm / 3.25 inches
Depth	52 mm / 2.047 inches

### Mechanical data

Mounting type	Pluggable module for receptacle terminal blocks
---------------	---

### Material Data

Color	gray
Fire load	0.416 MJ
Weight	23.4 g

### Environmental requirements

Ambient temperature (operation at $U_N$ )	-25 ... +40 °C
Ambient temperature (storage)	-25 ... +40 °C
Processing temperature	-25 ... +50 °C
Relative humidity	5 ... 95 % (no condensation permissible)
Operating altitude (max.)	2000 m

### Standards and specifications

Standards/specifications	EN 60664-1
--------------------------	------------

### Commercial data

Product Group	6 (INTERFACE ELECTRONIC)
eCl@ss 10.0	27-26-15-03
eCl@ss 9.0	27-26-15-03
ETIM 8.0	EC001504
ETIM 7.0	EC001504
PU (SPU)	10 (1) pcs
Packaging type	Box
Country of origin	DE
GTIN	4045454860448

Subject to changes. Please also observe the further product documentation!

Customs tariff number

85365005000

## Environmental Product Compliance

RoHS Compliance Status

Compliant, No Exemption

## Approvals / Certificates

### General approvals

Logo	Approval	Additional Approval Text	Certificate name
	EAC Brjansker Zertifizierungsstelle	TP TC 020/2011	EAC_Certificate_RU_C-DE.AM02.B.00115_19

## Optional accessories

### Marking accessories

Marker



Item no.: 209-701

WSB marking card; as card; not stretchable; plain; snap-on type; white

[www.wago.com/209-701](http://www.wago.com/209-701)

### Terminal blocks

Terminal block for pluggable modules



Item no.: 280-628

Terminal block for pluggable modules; 8-pole; with 4-conductor terminal blocks; with orange separator; [www.wago.com/280-628](http://www.wago.com/280-628) for DIN-rail 35 x 15 and 35 x 7.5; 2.5 mm<sup>2</sup>; CAGE CLAMP®; 2,50 mm<sup>2</sup>; gray

Item no.: 280-638

Terminal block for pluggable modules; 8-pole; with 2-conductor terminal blocks; with orange separator; [www.wago.com/280-638](http://www.wago.com/280-638) for DIN-rail 35 x 15 and 35 x 7.5; 2.5 mm<sup>2</sup>; CAGE CLAMP®; 2,50 mm<sup>2</sup>; gray

Item no.: 280-764

Terminal block for pluggable modules; 8-pole; with 4-conductor terminal blocks; with marker carrier; [www.wago.com/280-764](http://www.wago.com/280-764) with orange separator; for DIN-rail 35 x 15 and 35 x 7.5; 2.5 mm<sup>2</sup>; CAGE CLAMP®; 2,50 mm<sup>2</sup>; gray

## Downloads

### Documentation

#### Bid Text

286-792	2019 Feb 20	docx	Download
docx - Datei		15.6 kB	
286-792	2019 Feb 19	xml	Download
		3.8 kB	

Subject to changes. Please also observe the further product documentation!

WAGO GmbH &amp; Co. KG

Hansastr. 27

32423 Minden

Phone: +49571 887-0 | Fax: +49571 887-169

Email: [info.de@wago.com](mailto:info.de@wago.com) | Web: [www.wago.com](http://www.wago.com)

Do you have any questions about our products?

We are always happy to take your call at +49 (571) 887-44222.

X81 - Datei

### Instruction Leaflet

pdf  
1.3 MB

[Download](#)

### Additional Information

Disposal and Recycling Electrical and electronic equipment, Batteries, Packaging	V 1.1.0 2022 Aug 18	pdf 2.2 MB	<a href="#">Download</a>
---	------------------------	---------------	--------------------------

### CAD/CAE-Data

#### CAE data

WSCAD Universe 286-792	URL	<a href="#">Download</a>
------------------------	-----	--------------------------

### Environmental Product Compliance

#### Compliance Search

Environmental Product Compliance 286-792 Optocoupler module; Red status indicator; gray	URL	<a href="#">Download</a>
--	-----	--------------------------

### Installation Notes

#### Installation

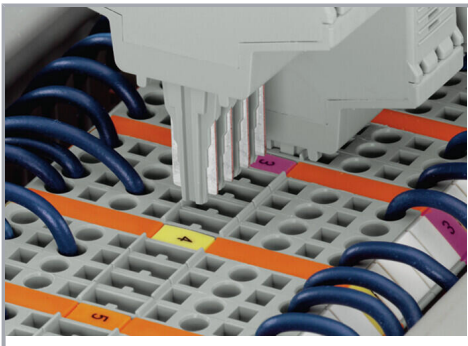

Coding ensures correct polarity.

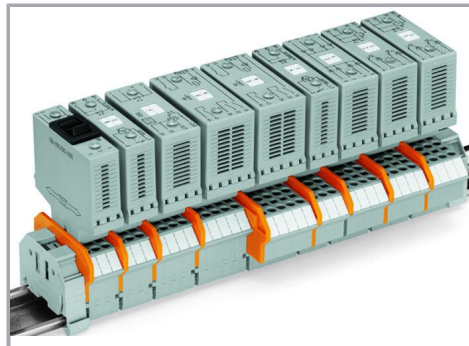

Pluggable electronic modules on 2- or 4-conductor carrier terminal blocks

#### Marking

Subject to changes. Please also observe the further product documentation!

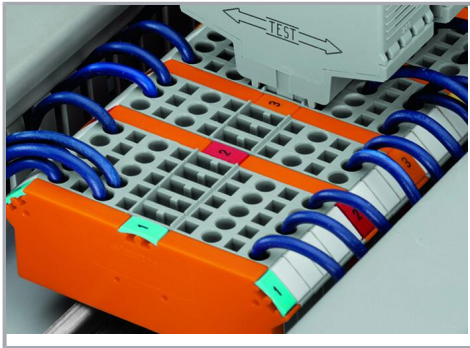

Marking via WMB Multi Marking System.

### Testing



Function testing via touch-proof test slots

Subject to changes. Please also observe the further product documentation!