

CONFIGURATION	PART NUMBER
Female Jamnut Receptacle, 23 Pin, 16 Awg, Shell 18	RT071823SNH

DIMENSIONS

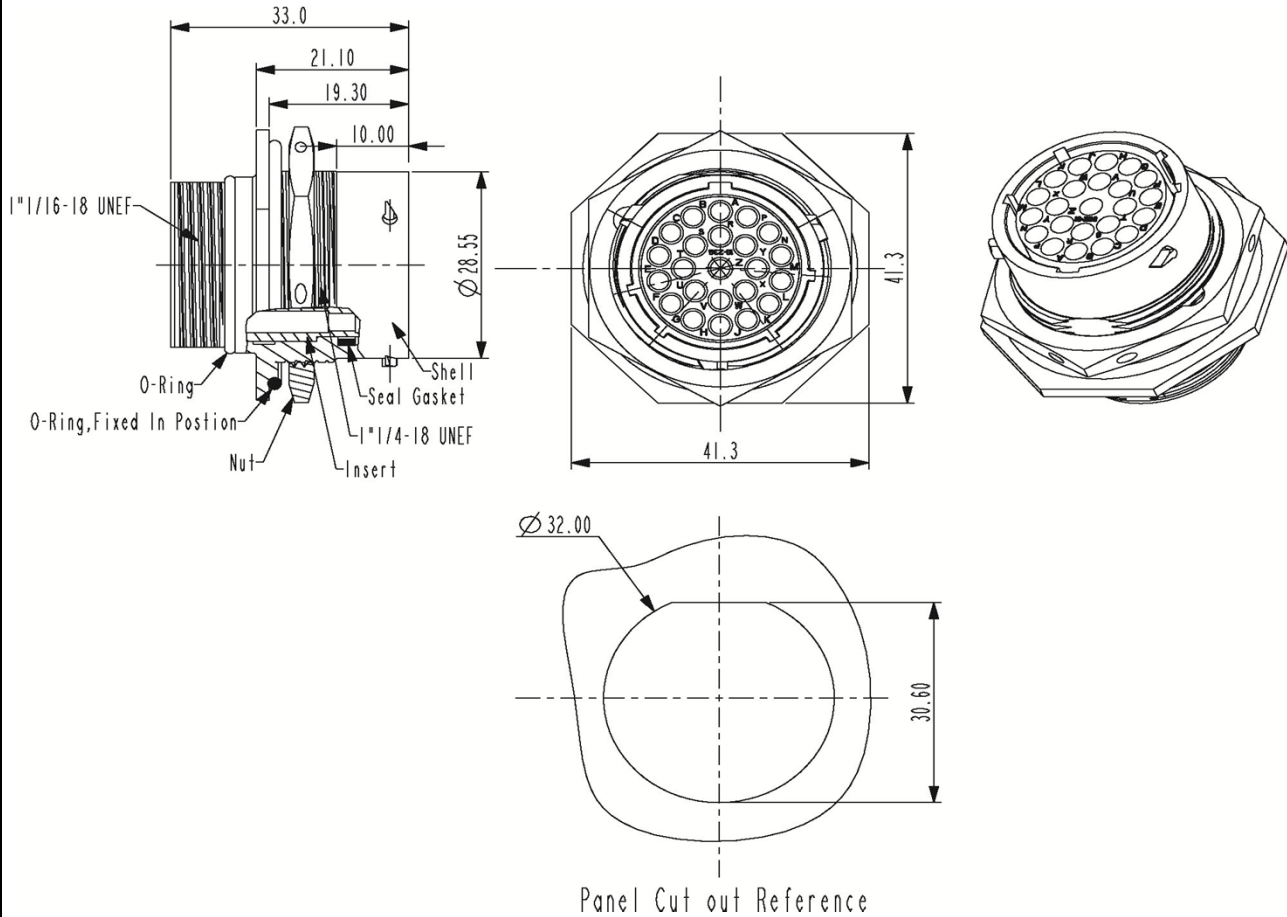

TECHNICAL DATA

TEMPERATURE RANGE:	-40°C to + 105°C
PROTECTION:	IP67 in mated condition and in combination with sealed backshell
VOLTAGE RATING:	250V
HOUSING BODY:	Zinc Alloy, Nickel Plated
COUPLING NUT:	-
INSERT:	Glass-filled Thermoplastic UL94-V0
SEAL:	NBR
CURRENT:	13A
CONTACT SIZE:	16Awg
APPROVALS:	UL ECBT2