



User Manual

HPC-7480

**4U Tower/Rackmount Chassis
for EATX Serverboard with
8 Hot-swap Hard Drive Cages**

ADVANTECH

Enabling an Intelligent Planet

Copyright

The documentation and the software included with this product are copyrighted 2011 by Advantech Co., Ltd. All rights are reserved. Advantech Co., Ltd. reserves the right to make improvements in the products described in this manual at any time without notice. No part of this manual may be reproduced, copied, translated or transmitted in any form or by any means without the prior written permission of Advantech Co., Ltd. Information provided in this manual is intended to be accurate and reliable. However, Advantech Co., Ltd. assumes no responsibility for its use, nor for any infringements of the rights of third parties, which may result from its use.

Acknowledgements

HPC-7480 is trademarks of Advantech Co., Ltd.

All other product names or trademarks are properties of their respective owners.

On-line Technical Support

For technical support and service, please visit our support website at:

<http://www.advantech.com/support>

Product Warranty (2 years)

Advantech warrants to you, the original purchaser, that each of its products will be free from defects in materials and workmanship for two years from the date of purchase.

This warranty does not apply to any products which have been repaired or altered by persons other than repair personnel authorized by Advantech, or which have been subject to misuse, abuse, accident or improper installation. Advantech assumes no liability under the terms of this warranty as a consequence of such events.

Because of Advantech's high quality-control standards and rigorous testing, most of our customers never need to use our repair service. If an Advantech product is defective, it will be repaired or replaced at no charge during the warranty period. For out-of-warranty repairs, you will be billed according to the cost of replacement materials, service time and freight. Please consult your dealer for more details.

If you think you have a defective product, follow these steps:

1. Collect all the information about the problem encountered. (For example, CPU speed, Advantech products used, other hardware and software used, etc.) Note anything abnormal and list any onscreen messages you get when the problem occurs.
2. Call your dealer and describe the problem. Please have your manual, product, and any helpful information readily available.
3. If your product is diagnosed as defective, obtain an RMA (return merchandise authorization) number from your dealer. This allows us to process your return more quickly.
4. Carefully pack the defective product, a fully-completed Repair and Replacement Order Card and a photocopy proof of purchase date (such as your sales receipt) in a shippable container. A product returned without proof of the purchase date is not eligible for warranty service.
5. Write the RMA number visibly on the outside of the package and ship it prepaid to your dealer.

Part No. 2006C74800

Printed in Taiwan

Edition 1

June 2011

Safety Instructions

1. Read these safety instructions carefully.
2. Keep this User Manual for later reference.
3. Disconnect this equipment from any AC outlet before cleaning. Use a damp cloth. Do not use liquid or spray detergents for cleaning.
4. For plug-in equipment, the power outlet socket must be located near the equipment and must be easily accessible.
5. Keep this equipment away from humidity.
6. Put this equipment on a reliable surface during installation. Dropping it or letting it fall may cause damage.
7. Do not leave this equipment in an environment unconditioned where the storage temperature under 0°C (32°F) or above 40°C (104°F), it may damage the equipment.
8. The openings on the enclosure are for air convection. Protect the equipment from overheating. **DO NOT COVER THE OPENINGS.**
9. Make sure the voltage of the power source is correct before connecting the equipment to the power outlet.
10. Position the power cord so that people cannot step on it. Do not place anything over the power cord.
11. All cautions and warnings on the equipment should be noted.
12. If the equipment is not used for a long time, disconnect it from the power source to avoid damage by transient overvoltage.
13. Never pour any liquid into an opening. This may cause fire or electrical shock.
14. Never open the equipment. For safety reasons, the equipment should be opened only by qualified service personnel.
15. If one of the following situations arises, get the equipment checked by service personnel:
 - The power cord or plug is damaged.
 - Liquid has penetrated into the equipment.
 - The equipment has been exposed to moisture.
 - The equipment does not work well, or you cannot get it to work according to the user's manual.
 - The equipment has been dropped and damaged.
 - The equipment has obvious signs of breakage.
16. Caution: The computer is provided with a battery-powered real-time clock circuit. There is a danger of explosion if battery is incorrectly replaced. replace only with same or equivalent type recommended by the manufacture. discard used batteries according to the manufacturers instructions.
17. THE COMPUTER IS PROVIDED WITH CD DRIVES COMPLY WITH APPROPRIATE SAFETY STANDARDS INCLUDING IEC 60825.
CLASS 1 LASER PRODUCT
KLASSE 1 LASER PRODUKT
18. This device complies with Part 15 of the FCC rules. Operation is subject to the following two conditions:
 - (1) this device may not cause harmful interference, and
 - (2) this device must accept any interference received, including interference that may cause undesired operation
19. Caution: Always completely disconnect the power cord from your chassis whenever you work with the hardware. do not make connections while the power is on. sensitive electronic components can be damaged by sudden power surges

-
20. Caution: Always ground yourself to remove any static charge before touching the motherboard, backplane, or add-on cards. modern electronic devices are very sensitive to static electric charges. as a safety precaution, use a grounding wrist strap at all times. place all electronic components on a static-dissipative surface or in a static-shielded bag when they are not in the chassis
 21. Caution: Any unverified component could cause unexpected damage. to ensure the correct installation, please always use the components (ex. screws) provided with the accessory box.

A Message to the Customer

Advantech customer services

Each and every Advantech product is built to the most exacting specifications to ensure reliable performance in the harsh and demanding conditions typical of industrial environments. Whether your new Advantech equipment is destined for the laboratory or the factory floor, you can be assured that your product will provide the reliability and ease of operation for which the name Advantech has come to be known. Your satisfaction is our primary concern. Here is a guide to Advantech's customer services.

To ensure you get the full benefit of our services, please follow the instructions below carefully.

Technical support

We want you to get the best performance possible from your products. If you run into technical difficulties, we are here to help. For the most frequently asked questions, you can easily find answers in your product documentation. These answers are normally a lot more detailed than the ones we can give over the phone.

Please consult this manual first. If you still cannot find the answer, gather all the information or questions that apply to your problem, and with the product close at hand, call your dealer. Our dealers are well trained and ready to give you the support you need to get the most from your Advantech products. In fact, most problems reported are minor and can be easily solved over the phone.

In addition, free technical support is available from Advantech engineers every businessday. We are always ready to give advice about application requirements or specific information on the installation and operation of any of our products.

Initial Inspection

When you open the carton, please make sure that the following materials have been shipped:

Standard Parts List

- Chassis
 - 1 x HPC-7480 Chassis
- Components
 - 1 x 665W PS2 power supply
 - 4 x 80*38mm 4-pin PWM fan (middle)
 - 8 x HDD tray
 - 1 x SAS/SATA hard drive backplane
 - 1 x Front I/O panel board
 - 1 x Front bezel with key
- Accessories
 - 1 x Startup manual
 - 1 x Warranty card
 - 1 x Accessory box with a package of screws
 - 1 x Front panel cable
 - 2 x System fan cable(1 to 2)

If any of these items are missing or damaged, contact your distributor or sales representative immediately. We have carefully inspected the HPC-7480 mechanically and electrically before shipment. It should be free of marks and scratches and in perfect working order upon receipt. As you unpack the HPC-7480, check it for signs of shipping damage. (For example, damaged box, scratches, dents, etc.) If it is damaged or it fails to meet the specifications, notify our service department or your local sales representative immediately. Also, please notify the carrier. Retain the shipping carton and packing material for inspection by the carrier. After inspection, we will make arrangements to repair or replace the unit.

Contents

Chapter 1	General Information	1
1.1	Introduction	2
1.2	Specifications	2
1.3	Power Supply Specifications	2
	Table 1.1: Power supply	2
1.4	Environment Specifications	2
	Table 1.2: Environment specifications	2
1.5	Dimension Diagram	3
	Figure 1.1 Dimension Diagram	3
Chapter 2	System Setup	5
2.1	Overview	6
2.2	Removing the Chassis Cover	6
	2.2.1 Disconnecting the Chassis from the Power Source	6
	2.2.2 Removing the Chassis Cover	6
	Figure 2.1 Removing the Chassis Cover	6
2.3	Accessing the Hot-Swappable Drive Trays	7
	2.3.1 Accessing and Installing Hard Drives	7
	Figure 2.2 Removing Hard Drive Trays	7
2.4	Installing Fixed Hard Drives in HPC-7480 Chassis Models	7
	2.4.1 Disconnecting the Chassis from the Power Source	7
	Figure 2.3 Removing Hard Drive Trays	8
2.5	Installing Hard Drives into the Drive Trays	8
	2.5.1 Installing Hard Drives	8
	Figure 2.4 Hard Drive Trays	8
2.6	Configuring the Storage Module	8
	2.6.1 Storage Module Options	8
	2.6.2 Removing the Storage Module	9
	Figure 2.5 Removing the Storage Module	9
	2.6.3 Configuring the Storage Module for 5.25" Devices	9
	Figure 2.6 Installing 5.25" Devices into the Storage Module	9
2.7	Removing and Replacing the System Fans	10
	2.7.1 Standard Cooling Systems	10
	Figure 2.7 Removing the Middle Chassis Fans	10
2.8	Removing Rear Chassis Fans	10
	Figure 2.8 Removing Rear Chassis Fans	10
2.9	Installing the Motherboard	11
	2.9.1 Prior to Installing the Motherboard	11
	2.9.2 Motherboard Installation	11
	Figure 2.9 Installing the Motherboard	11
2.10	Installing Expansion Cards	12
	2.10.1 Installing Expansion Cards	12
	Figure 2.10 Installing Expansion Cards	12
Chapter 3	Operation	13
3.1	The Front Panel	14
	3.1.1 Switch, Button and I/O Interfaces	14
	3.1.2 LED Indicators for System Status	14
	Figure 3.1 Front control panel	14
3.2	Control Panel Buttons	15
3.3	Control Panel LEDs	15

Chapter 4 SATA/SAS Backplane..... 17

4.1	SAS Backplane Specifications.....	18
4.1.1	ESD Safety Guidelines	18
4.1.2	General Safety Guidelines.....	18
4.1.3	An Important Note to Users	18
4.1.4	Introduction to the SAS Backplane	18
4.1.5	Front Connectors.....	19
	Figure 4.1 Front Connectors.....	19
	Table 4.1: Connectors and Jumpers	19
4.1.6	Front Connector and Pin Definitions.....	19
	Table 4.2: Backplane Main Power 4-Pin Connector Pin Definition	19
	Table 4.3: Sideband Headers.....	20
	Table 4.4: I2C Connector Pin Definitions	20
4.1.7	Front Jumper Locations and Pin Definitions.....	21
	Figure 4.2 Front Jumpers	21
	Table 4.5: Jumper Settings	22
	Table 4.6: I2C and SGPIO Settings	23
	Table 4.7: SAS Port Connections in I2C and SGPIO Settings..	23
	Figure 4.3 Front Panel LEDs.....	23
	Table 4.8: Front Panel LEDs.....	23
4.1.8	Rear Connectors and LED Indicators.....	24
	Figure 4.4 Rear Connectors	24
	Table 4.9: Rear SAS/SATA Connectors.....	24
	Table 4.10: Rear LED Indicators	24
4.2	SATA Backplane Specifications.....	25
4.2.1	ESD Safety Guidelines	25
4.2.2	General Safety Guidelines.....	25
4.2.3	An Important Note to Users	25
4.2.4	Introduction to the SATA Backplane.....	25
4.2.5	Front Connectors and Jumpers	26
	Figure 4.5 Front Connectors.....	26
	Table 4.11: Connectors and Jumpers	26
4.2.6	Front Connector and Jumper Pin Definitions.....	26
	Table 4.12: Backplane Main Power Connector Pin Definition.....	26
	Table 4.13: SATA Activity LED Header Pin Definitions.....	27
4.2.7	Front Jumper Locations and Pin Definitions.....	27
	Figure 4.6 Front Jumpers	27
	Table 4.14: Socket Settings	27
	Figure 4.7 Front LEDs	29
	Table 4.15: Front Panel LEDs.....	29
4.2.8	Rear Connectors and LED Indicators Rear Connectors.....	29
	Figure 4.8 Rear Connectors	29
	Table 4.16: Rear SATA Connectors.....	29
	Figure 4.9 Rear LEDs.....	30
	Table 4.17: Rear LED Indicators	30

Appendix A Chassis Screws..... 31

A.1	Chassis Screws	32
-----	----------------------	----

Chapter 1

General Information

1.1 Introduction

HPC-7480 is a 4U-high rackmount industrial computer chassis for high-performance and high-capacity computing applications. It meets a variety of application needs for filing, printing, e-mail and web serving. This powerful computing platform is suitable for mission-critical computer telephony applications, industrial automation, and factory management. A wide range of standard computing peripherals can be integrated with the chassis to meet different application needs for operation under harsh conditions 24 hours a day, 7 days a week.

1.2 Specifications

- **Construction:** Heavy-duty steel
- **Disk Drive Capacity:** Three 5.25" disk drives
- **LED Indicators on Front Panel:** Bi-color LEDs (green/red) for Power, Temperature, and Fan status; single-color LEDs (green) for HDD activity and LAN status.
- **Switch and Buttons on Front Panel:** power switch, system reset button.
- **Front I/O Interfaces:** two dual USB ports.
- **Cooling System:** Four 80 mm x 38 mm hot-swappable cooling fans.
- **Air Filters:** One easily-maintained filter, behind the front door.
- **Weight:** 29.94 kg
- **Dimensions (W x H x D):** 178 x 452 x 648 mm

1.3 Power Supply Specifications

Table 1.1: Power supply

Model	665 W PS2 power supply with 8cm fan
Watt	665 W AC-DC power supply
Input Rating	100 - 240 V, 50-60 Hz, 10-5 Amp
Output Voltage	+3.3 V @ 24 A, +5V @ 30 A, 5 Vsb @ 6 A, +12 V @ 54 A, -12 V @ 0.5 A,
Safety	UL/TUV/CB/CCC

1.4 Environment Specifications

Table 1.2: Environment specifications

Environment	Operating	Non-operating
Temperature	0° C ~ 40° C	-40° C ~ 70° C
Humidity	10 ~ 85% @ 40° C Non-Condensing	10 ~ 85% @ 40° C Non-Condensing

1.5 Dimension Diagram

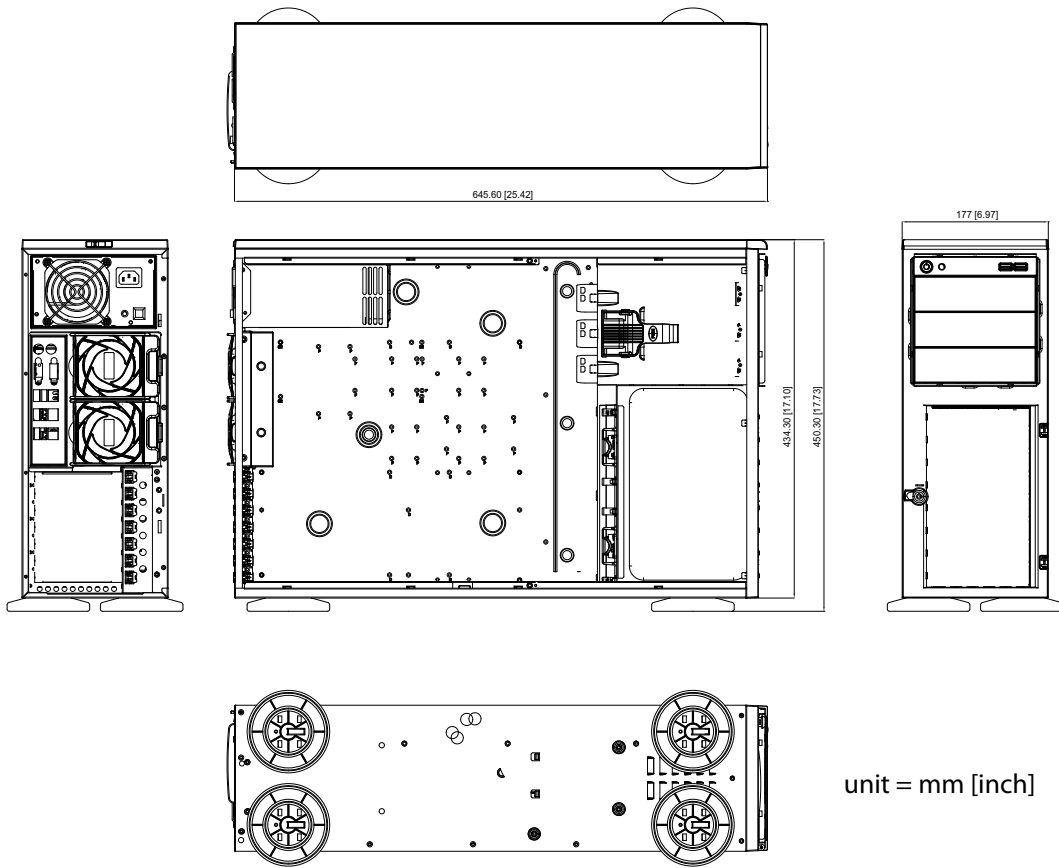

Figure 1.1 Dimension Diagram

Chapter 2

System Setup

2.1 Overview

The following procedures instruct users on how to install a backplane/motherboard, add-on cards and disk drives into the HPC-7480. Please also refer to Appendix A, Exploded Diagram, for the detailed parts of HPC-7480.

Caution! Use caution when installing or operating the components with the chassis open. Be sure to turn off the power, unplug the power cord and ground yourself by touching the metal chassis before you handle any components inside the machine.



2.2 Removing the Chassis Cover

2.2.1 Disconnecting the Chassis from the Power Source

1. Turn off all peripheral devices and turn off the power supply to the HPC-7480.
2. Disconnect the AC power cords from the system.
3. Disconnect all cables and label the cables for easy identification.

Warning! Use a grounded wrist strap designed to prevent static discharge when handling components.



After completing the above steps, you can remove the chassis cover and install components and devices into the chassis as described in this chapter.

2.2.2 Removing the Chassis Cover

1. Press the release tab to unlock the cover.
2. The release tab will pop open as shown.
3. Slide the cover back and off of the chassis.

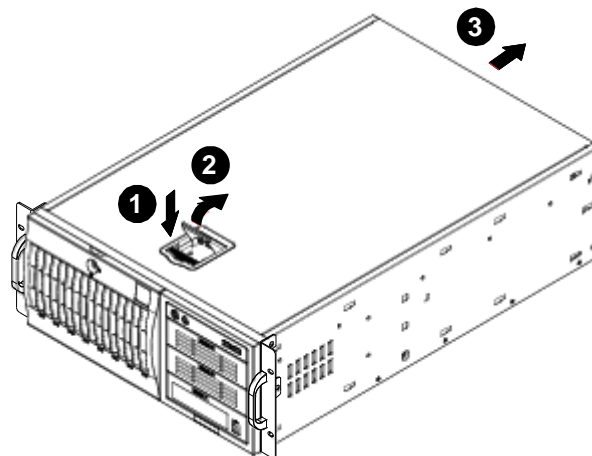

Figure 2.1 Removing the Chassis Cover

2.3 Accessing the Hot-Swappable Drive Trays

Hot-swappable drives may be removed and installed from the chassis without powering-down the system and without opening the chassis cover.

2.3.1 Accessing and Installing Hard Drives

1. Unlock and open the drive tray door as shown.
2. Press the release tab located on the drive tray door to release the drive tray from its locking position.
3. Lift up the drive tray handle.
4. Pull the drive tray door downward and pull the drive tray out from the chassis. (Note: The orientation of the picture shown below is for rack mount systems.)

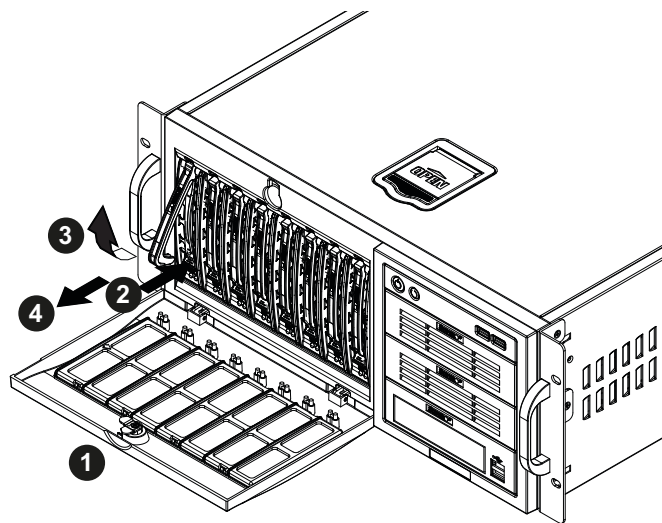

Figure 2.2 Removing Hard Drive Trays

2.4 Installing Fixed Hard Drives in HPC-7480 Chassis Models

2.4.1 Disconnecting the Chassis from the Power Source

1. Turn off all peripheral devices and turn off the power supply to the HPC-7480.
2. Disconnect the AC power cord from the system.
3. Disconnect all cables and label the cables for easy identification.
4. Open the chassis cover as described in section 2.2.
5. Disconnect the wiring which the hard drive to either the motherboard or the expansion card of the motherboard, depending upon your chassis model.
6. Unlock and open the drive tray door as shown.
7. Press the release tab located on the drive tray door to release the drive tray from its locking position.
8. Lift up the drive tray handle.
9. Pull the drive tray door downward and pull the drive tray out from the chassis. (Note: The orientation of the picture shown below is for rack mount systems.)

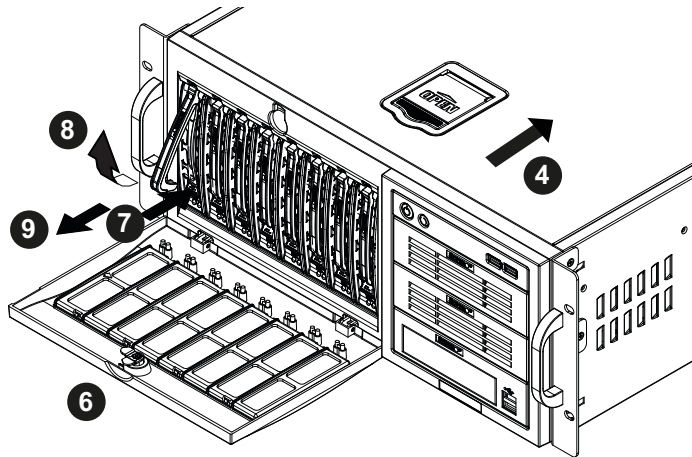

Figure 2.3 Removing Hard Drive Trays

2.5 Installing Hard Drives into the Drive Trays

2.5.1 Installing Hard Drives

1. Remove the screws from the hard drive tray and set them aside for later use.
2. Remove the dummy drive from the hard drive tray.
3. Mount a hard drive into the hard drive tray
4. Replace the screws which were set aside earlier.
5. Install the hard drive into the chassis.
6. Push down the release tab over the newly installed hard drive.
7. Close the hard drive tray door.

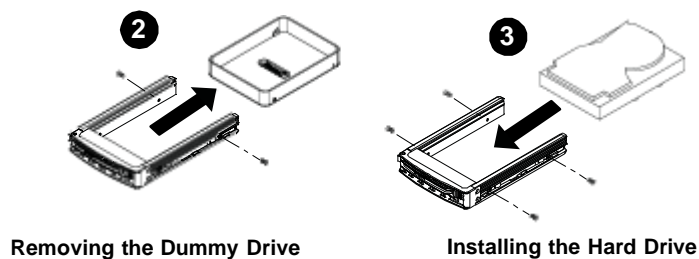

Figure 2.4 Hard Drive Trays

2.6 Configuring the Storage Module

2.6.1 Storage Module Options

The storage module can be configured to accommodate a variety of data storage devices such as CD, IDE, DVD, tape and floppy drives. The chassis may be rotated from a vertical tower position, to a horizontal rack mounting position to accommodate use of these devices. The following configurations may be used in the HPC-7480 chassis:

- **5.25" Drives:** Install any combination of three 5.25" devices.

2.6.2 Removing the Storage Module

1. Locate the release tab on top of the storage module as shown below. Press the release tab to unlock the storage module.
2. Once unlocked, push the module forward and out of the chassis.

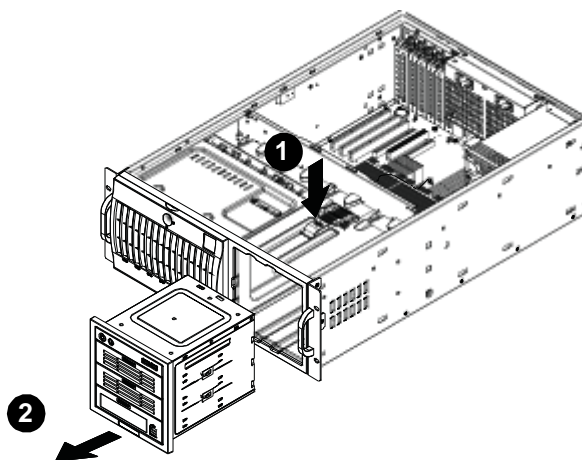

Figure 2.5 Removing the Storage Module

2.6.3 Configuring the Storage Module for 5.25" Devices

1. Remove the 5.25" drive trays from the storage module.
2. Remove the screws and drive tray brackets from the drive trays.
3. Install the 5.25" devices into the storage module.
4. Replace the module back into the chassis.
5. Ensure that the storage module is securely locked into position.

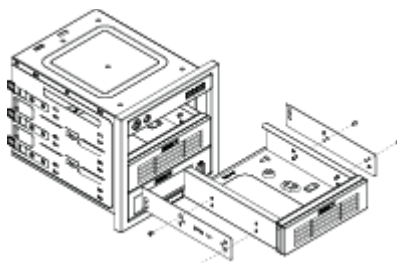

Figure 2.6 Installing 5.25" Devices into the Storage Module

2.7 Removing and Replacing the System Fans

Before installing the motherboard in the chassis or accessing the motherboard after installation, it is necessary to remove the system fans. One set is located at the rear of the chassis, the other set is located in the middle of the chassis.

2.7.1 Standard Cooling Systems

HPC-7480 chassis include mid-chassis cooling fans, rear cooling fans and an air shroud to channel air within the chassis.

Removing and Replacing Mid-chassis Fans

1. Press the release tab located on the left side of the middle chassis fan
2. While holding down the release tab, pull the fan upwards, and out of the chassis.
3. When replacing the middle chassis fan, push the fan back into the fan module slot until a click is heard, indicating that the fan has locked into position.

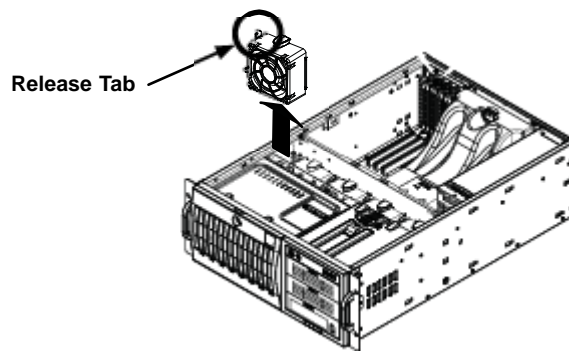

Figure 2.7 Removing the Middle Chassis Fans

2.8 Removing Rear Chassis Fans

1. Locate the release tab on the top of the chassis fan, at the rear of the chassis. Push the release tab down to unlock the fan.
2. Once the fan is unlocked, tip it forward and out of the chassis.
3. When replacing the rear chassis fan, push the fan back into the fan module until a click is heard, indicating that the fan has locked into position.

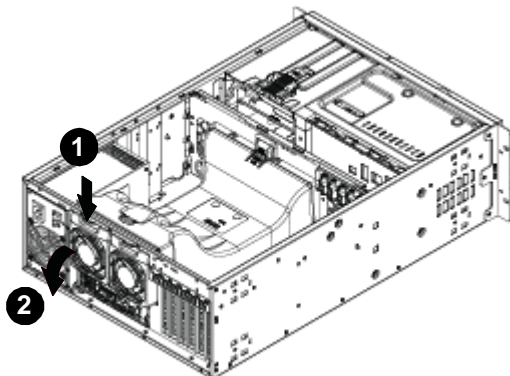

Figure 2.8 Removing Rear Chassis Fans

2.9 Installing the Motherboard

2.9.1 Prior to Installing the Motherboard

Before the motherboard can be installed or removed, the middle and rear system fans must be removed, as directed in sections 2.7.

Identify the locations of the following components:

- Processor(s)
- Mounting holes
- Retention brackets
- Type A (6-32) screws (included in the chassis accessory kit)

Obtain the following parts for the motherboard being used. These should be included with the motherboard. (Refer to the motherboard documentation for details)

- I/O shield
- Chassis standoffs
- Heatsink retention brackets

2.9.2 Motherboard Installation

Installing the Motherboard

1. Disconnect the power supply.
2. Lay the chassis on a flat surface.
3. Locate the mounting holes on the chassis.
4. Install the standoffs into the holes in the chassis.
5. Install the I/O shield as directed by the motherboard documentation.
6. Secure the heatsink to the motherboard as directed by the motherboard documentation.
7. Secure the motherboard to the chassis using Type A screws, which are included in the chassis accessory kit. Do not exceed eight pounds of torque per square inch when tightening down the motherboard.
8. Replace the middle and rear system fans as directed in section 2.7.

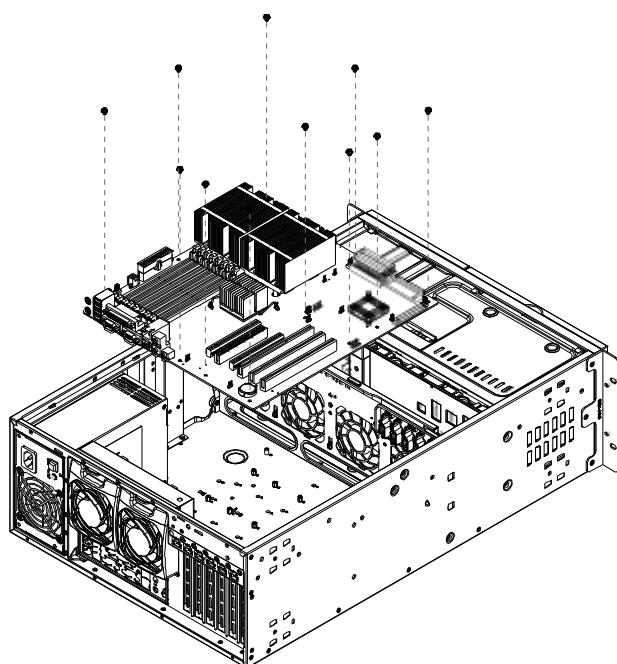

Figure 2.9 Installing the Motherboard

Warning! *The system fans and chassis cover must be installed prior to operating the system. Out-of-warranty damage may result if the system is operated without proper cooling protection in place.*



2.10 Installing Expansion Cards

After installing the motherboard, expansion cards such as PCI cards may be installed into the chassis.

2.10.1 Installing Expansion Cards

1. Locate the release tab on the top of the expansion card bracket
2. Gently apply pressure on the middle of the release tab to unlock the bracket as shown.

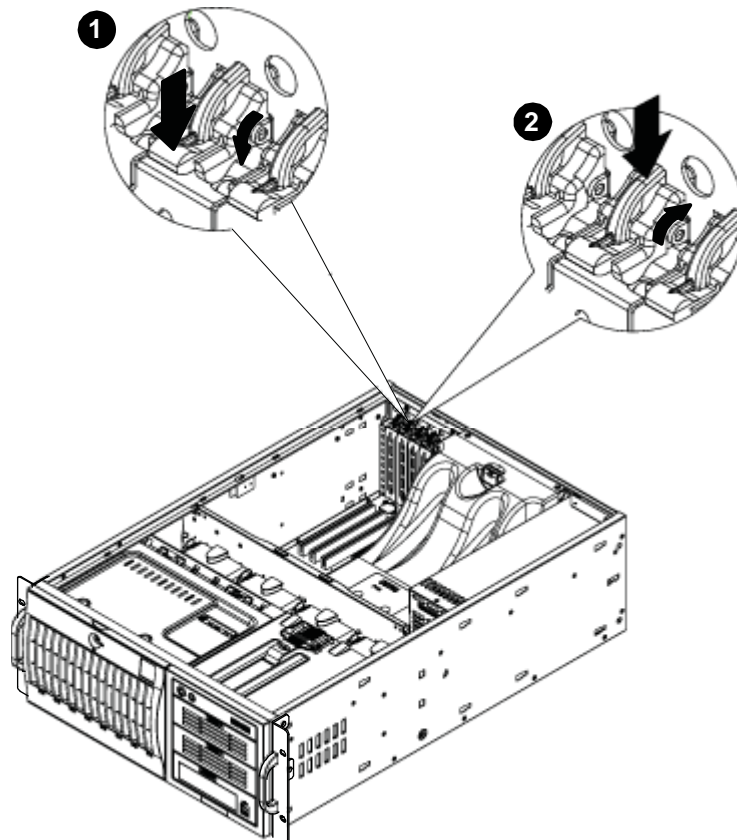

Figure 2.10 Installing Expansion Cards

Chapter 3

Operation

3.1 The Front Panel

The front panel features a lockable door. The user can close the door with or without the key using the user-friendly rotary lock. Upon opening the door, one sees eight 3.5" SAS/SATA hot-swap hard drive trays. There is a momentary power switch, two reserved system reset buttons, dual USB ports, and six LED indicators. Their individual functions are described as below.

3.1.1 Switch, Button and I/O Interfaces

- **Momentary Power switch:** Press this switch to turn the system power on or off. Please use system shutdown or press this switch for few seconds to turn off the system ATX power.
- **System Reset button:** Press this button to reboot the system.
- **Dual USB ports:** For connecting a wide range of USB devices for data transfer, backup or input.

3.1.2 LED Indicators for System Status

The following diagram defines each component of the front LED panel.

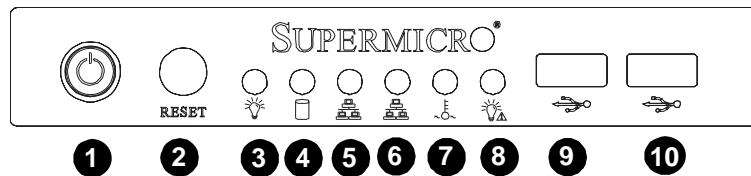

Figure 3.1 Front control panel

1. Power Button
2. System Reset
3. Power Indicator
4. HDD Activity Indicator
5. LAN1 Indicator
6. LAN2 Indicator
7. CPU Temperature/Fan Failure Indicator
8. Power Failure Indicator
9. USB Port
10. USB Port

3.2 Control Panel Buttons

There are two push-buttons located on the front of the chassis. These are (in order from left to right) a reset button and a power on/off button.



- **Power:** The main power switch is used to apply or remove power from the power supply to the server system. Turning off system power with this button removes the main power but keeps standby power supplied to the system. Therefore, you must unplug system before servicing.



- **Reset:** The reset button is used to reboot the system.

3.3 Control Panel LEDs

The control panel located on the front of the HPC-7480 chassis has five LEDs. These LEDs provide you with critical information related to different parts of the system. This section explains what each LED indicates when illuminated and any corrective action you may need to take.



- **Power:** The main power switch is used to apply or remove power from the power supply to the server system. Turning off system power with this button removes the main power but keeps standby power supplied to the system. Therefore, you must unplug the system's power cord before servicing.



- **HDD:** Indicates IDE channel activity. SAS/SATA drive, SCSI drive, and/or DVD-ROM drive activity when flashing.



- **NIC1:** Indicates network activity on GLAN1 when flashing.



- **NIC2:** Indicates network activity on GLAN2 when flashing.



- **Overheat/Fan Fail:** When this LED flashes it indicates a fan failure. When continuously on (not flashing) it indicates an overheat condition, which may be caused by cables obstructing the air flow in the system or the ambient room temperature being too warm. Check the routing of the cables and make sure all fans are present and operating normally. You should also check to make sure that the chassis covers are installed. Finally, verify that the heatsinks are installed properly. This LED will remain flashing or on as long as the overheat condition exists.



- **Power Fail:** Indicates a power failure to the system's power supply units.

Chapter 4

SATA/SAS Backplane

4.1 SAS Backplane Specifications

To avoid personal injury and property damage, carefully follow all the safety steps listed below when accessing your system or handling the components.

4.1.1 ESD Safety Guidelines

- Electrostatic Discharge (ESD) can damage electronic components. To prevent damage to your system, it is important to handle it very carefully. The following measures are generally sufficient to protect your equipment from ESD.
- Use a grounded wrist strap designed to prevent static discharge.
- Touch a grounded metal object before removing a component from the antistatic bag.
- Handle the backplane by its edges only; do not touch its components, peripheral chips, memory modules or gold contacts.
- When handling chips or modules, avoid touching their pins.
- Put the card and peripherals back into their antistatic bags when not in use.

4.1.2 General Safety Guidelines

- Always disconnect power cables before installing or removing any components from the computer, including the backplane.
- Disconnect the power cable before installing or removing any cables from the backplane.
- Make sure that the backplane is securely and properly installed on the motherboard to prevent damage to the system due to power shortage.

4.1.3 An Important Note to Users

- All images and layouts shown in this user's guide are based upon the latest PCB revision available at the time of publishing. The card you have received may or may not look exactly the same as the graphics shown in this manual.

4.1.4 Introduction to the SAS Backplane

The SAS backplane has been designed to utilize the most up-to-date technology available, providing your system with reliable, high-quality performance.

4.1.5 Front Connectors

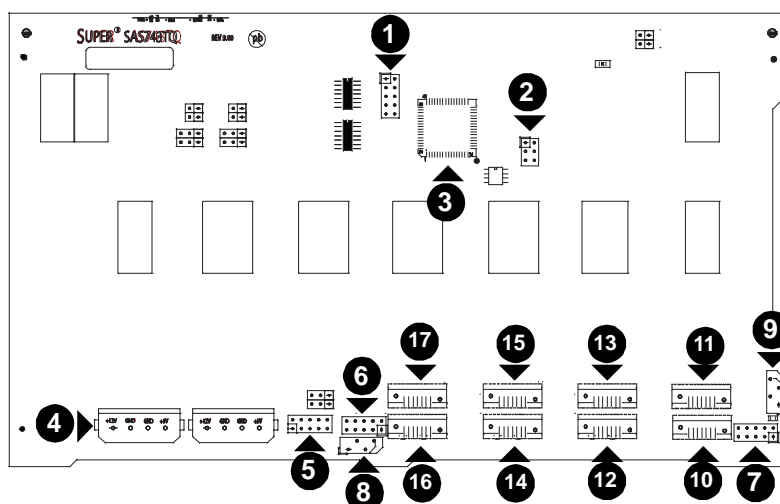

Figure 4.1 Front Connectors

Table 4.1: Connectors and Jumpers

1.	JTAG Connector: JP47	10.	SAS Port #0 J5
2.	Upgrade Connector: JP46	11.	SAS Port #1 J6
3.	Chip: MG9072	12.	SAS Port #2 J7 and JP13
4.	Power Connectors (4-pin): JP10,	13.	SAS Port #3 J8
5.	ACT IN: JP26	14.	SAS Port #4 J10
6.	Sideband Connector #2 JP52	15.	SAS Port #5 J12
7.	Sideband Connector #1 JP51	16.	SAS Port #6 J14
8.	I2C Connector #2 JP45	17.	SAS Port #7 J16
9.	I2C Connector #1 JP44		

4.1.6 Front Connector and Pin Definitions

4.1.6.1 #1. and 2. JTAG Connector and Upgrade Connectors

The JTAG and upgrade connectors, designated JP47 and JP46, are used for diagnostic purposes. These connectors should be used by a certified and experienced technician.

4.1.6.2 #3. MG9072 Chip

The MG9072 is an enclosure management chip that supports the SES-2 controller and SES-2 protocols.

4.1.6.3 #4. Backplane Main Power Connectors

The 4-pin connectors, designated JP10 and JP13, provide power to the backplane. See the table below for pin definitions.

Table 4.2: Backplane Main Power 4-Pin Connector Pin Definition

1	+12 V
2 and 3	Ground
4	+5 V

4.1.6.4 #5. Activity LED Header

The activity LED header, designated JP26, is used to indicate the activity status of each SAS drive. The Activity LED Header is located on the front panel. For the Activity LED Header to work properly, connect using a 10-pin LED cable.

4.1.6.5 #6. and #7. Sideband Headers

The sideband headers are designated JP51 and JP52. For SES-2 to work properly, you must connect an 10-pin sideband cable. See the table below for pin definitions.

Table 4.3: Sideband Headers

Pin #	Definition	Pin #	Definition
2	Backplane Addressing (SB5)	1	Controller ID (SB6)
4	Reset (SB4)	3	GND (SB2)
6	GND (SB3)	5	SDA (SB1)
8	Backplane ID (SB7)	7	SCL (SB0)
10	No Connection	9	No Connection

4.1.6.6 #8. and #9. I²C Connectors

The I²C connectors, designated JP44 and JP45, are used to monitor HDD activity and status. See the table below for pin Definitions.

Table 4.4: I2C Connector Pin Definitions

Pin#	Definition
1	Data
2	Ground
3	Clock
4	No Connection

4.1.6.7 #10. - #17. SAS Ports

The SAS ports are used to connect the SAS drive cables. The 8 ports are designated #0 - #7. Each port is also compatible with SATA drives. However, do NOT mix SAS and SATA drives in the same enclosure

4.1.7 Front Jumper Locations and Pin Definitions

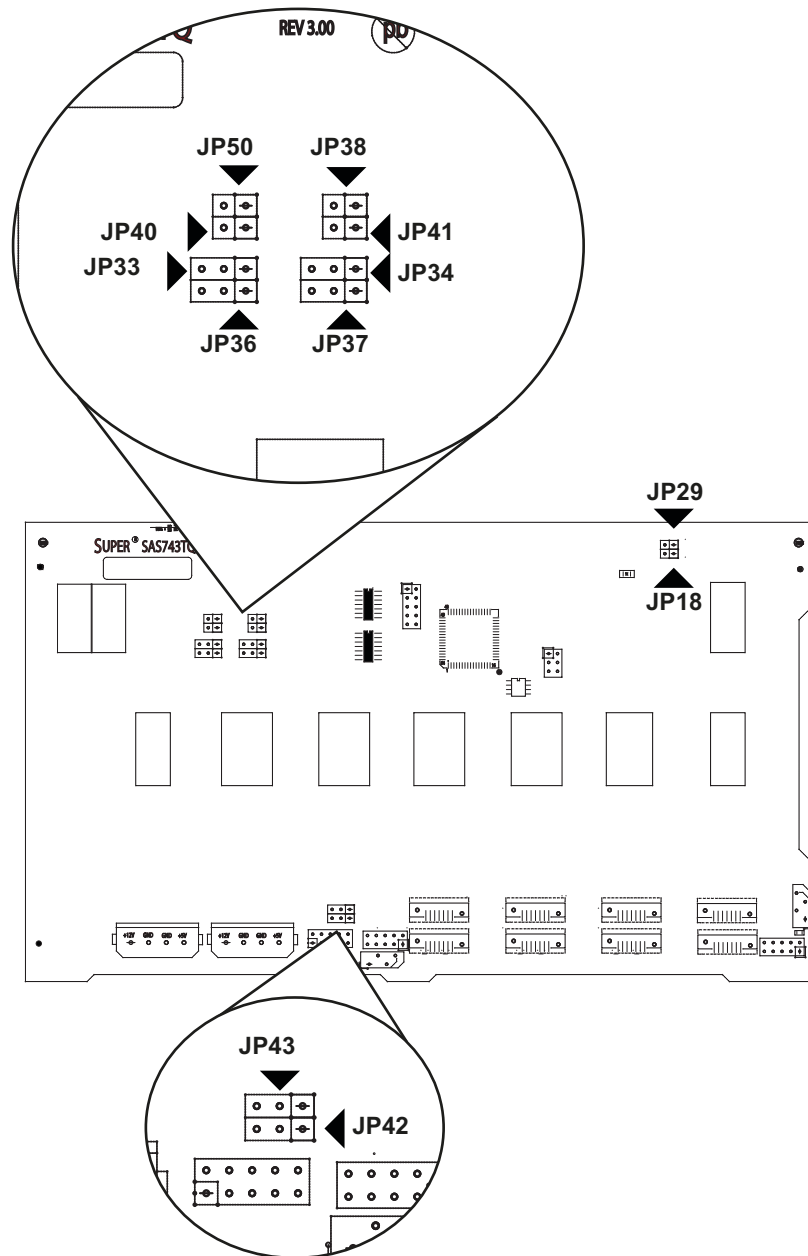

Figure 4.2 Front Jumpers

4.1.7.1 Explanation of Jumpers

To modify the operation of the backplane, jumpers can be used to choose between optional settings. Jumpers create shorts between two pins to change the function of the connector. Pin 1 is identified with a square solder pad on the printed circuit board.

Note! On two pin jumpers, "Closed" means the jumper is on and "Open" means the jumper is off the pins.

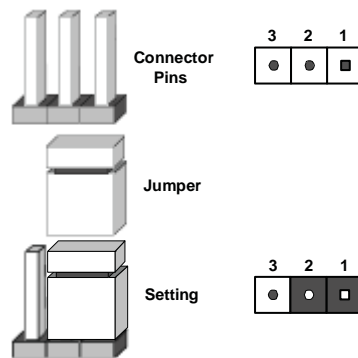

Table 4.5: Jumper Settings

Jumper	Jumper Settings	Note
JP18	Open: Enabled Closed: Disabled	Buzzer Reset*
JP29	Open: Enabled Closed: Disabled	Reset MG9072 Chip Reset

*The buzzer sound indicates that a condition requiring immediate attention has occurred.

The buzzer alarm is triggered by the following conditions:

- Hard drive failure
- Fan failure
- System temperature over 45° Celsius.

4.1.7.2 I²C and SGPIO Mode Jumper Settings

This backplane can utilize I²C or SGPIO. I²C is the default mode and can be used without making changes to your jumpers. The following information details which jumpers must be configured to use SGPIO mode or restore your backplane to I²C mode.

Table 4.6: I ² C and SGPIO Settings			
Jumper	I ² C Jumper Setting (Default)	SGPIO Jumper Setting	Note
JP33	2-3	1-2	Controller ID #1
JP34	1-2:ID#0	1-2	Backplane ID #1
JP36	2-3 1-2	Controller ID #2	
JP37	2-3:ID#1	1-2	Backplane ID #2
JP38	Closed	Open	I ² C Reset #2
JP40	Open	Closed	I ² C Reset SDOOUT #1
JP41	Open	Closed	I ² C Reset SDOOUT #2
JP42	2-3	1-2	Backplane ID SDIN #1
JP43	2-3	1-2	Backplane ID SDIN #2
JP50	Closed	Open I2C Reset #1	

4.1.7.3 SAS Port Connections in I²C and SGPIO Settings

Use the following chart when connecting this backplane. If you connect the SAS ports out of order, you will not be able to easily identify drives using the LED function.

Table 4.7: SAS Port Connections in I ² C and SGPIO Settings		
Port #	I ² C	SGPIO
# 0 - 3	I ² C #1	Sideband #1
# 4 - 7	I ² C #2	Sideband #2

4.1.7.4 Front LED Indicators

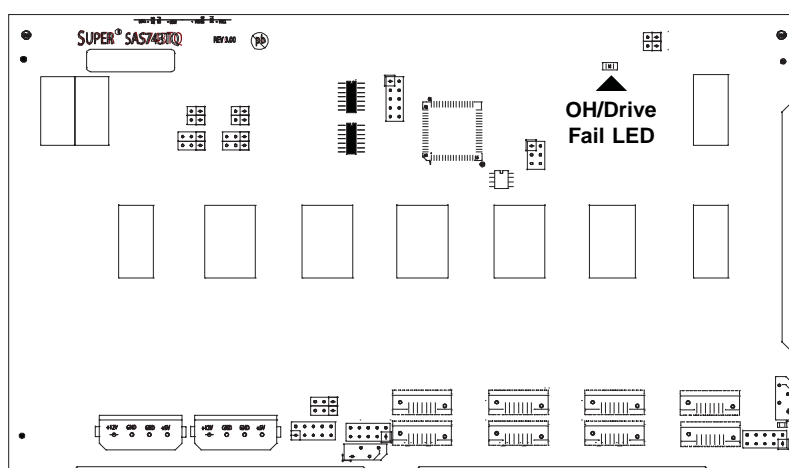

Figure 4.3 Front Panel LEDs

Table 4.8: Front Panel LEDs		
LED	State	Specification
D3	On	Overheat/drive failure LED indicator (Red light: flashing. Buzzer: On, if activated)

4.1.8 Rear Connectors and LED Indicators

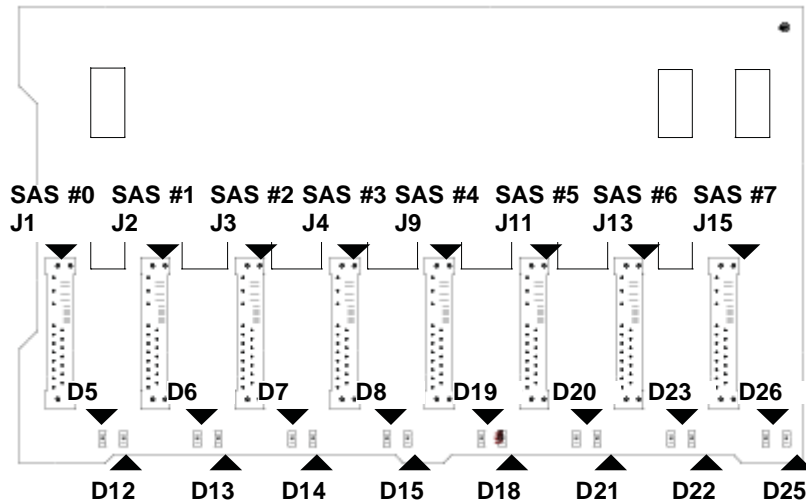

Figure 4.4 Rear Connectors

Table 4.9: Rear SAS/SATA Connectors

Rear Connector	SAS Drive Number
SAS #0	SAS/SATA HDD #0
SAS #1	SAS/SATA HDD #1
SAS #2	SAS/SATA HDD #2
SAS #3	SAS/SATA HDD #3
SAS #4	SAS/SATA HDD #4
SAS #5	SAS/SATA HDD #5
SAS #6	SAS/SATA HDD #6
SAS #7	SAS/SATA HDD #7

Table 4.10: Rear LED Indicators

Rear LED	Hard Drive Activity	Failure LED
SAS #0	D12	D5
SAS #1	D13	D6
SAS #2	D14	D7
SAS #3	D15	D8
SAS #4	D18	D19
SAS #5	D21	D20
SAS #6	D22	D23
SAS #7	D25	D26

4.2 SATA Backplane Specifications

To avoid personal injury and property damage, carefully follow all the safety steps listed below when accessing your system or handling the components.

4.2.1 ESD Safety Guidelines

Electrostatic Discharge (ESD) can damage electronic components. To prevent damage to your system, it is important to handle it very carefully. The following measures are generally sufficient to protect your equipment from ESD.

- Use a grounded wrist strap designed to prevent static discharge.
- Touch a grounded metal object before removing a component from the antistatic bag.
- Handle the backplane by its edges only; do not touch its components, peripheral chips, memory modules or gold contacts.
- When handling chips or modules, avoid touching their pins.
- Put the card and peripherals back into their antistatic bags when not in use.

4.2.2 General Safety Guidelines

- Always disconnect power cables before installing or removing any components from the computer, including the backplane.
- Disconnect the power cable before installing or removing any cables from the backplane.
- Make sure that the backplane is securely and properly installed on the motherboard to prevent damage to the system due to power shortage.

4.2.3 An Important Note to Users

All images and layouts shown in this user's guide are based upon the latest PCB revision available at the time of publishing. The card you have received may or may not look exactly the same as the graphics shown in this manual.

4.2.4 Introduction to the SATA Backplane

The SATA backplane has been designed to utilize the most up-to-date technology available, providing your system with reliable, high-quality performance.

4.2.5 Front Connectors and Jumpers

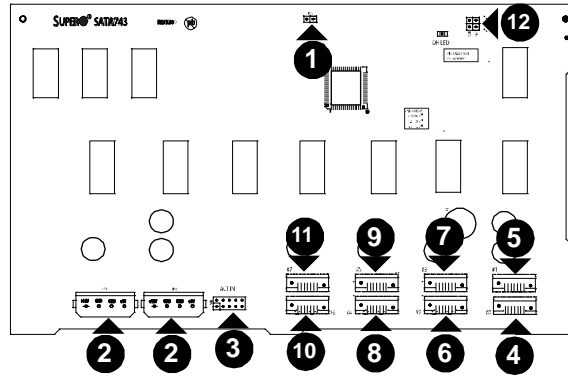

Figure 4.5 Front Connectors

Table 4.11: Connectors and Jumpers

1.	Overheat Temperature Setting:	7.	SATA Port #3: J8 JP25
2.	Power Connectors (4-pin): JP10 and JP13	8.	SATA Port #4: J10
3.	ACT_IN#0-7: JP26	9.	SATA Port #5: J12
4.	SATA Port #0: J5	10.	SATA Port #6: J14
5.	SATA Port #1: J6	11.	SATA Port #7: J16
6.	SATA Port #2: J7	12.	Buzzer Reset: JP18

4.2.6 Front Connector and Jumper Pin Definitions

4.2.6.1 1. Overheat Temperature Jumper

OH TEMP: JP25

Open: 45°C

1-2: 50°C (Default)

2-3: 55°C

4.2.6.2 2. Backplane Main Power Connectors

The 4-pin connectors designated JP10 and JP13 provide power to the backplane. See the table below for pin definitions.

Table 4.12: Backplane Main Power Connector Pin Definition

1	+12 V
2 and 3	Ground
4	+5 V

ackplane Main Power 4-Pin Connector Pin# De.nition

1 +12V

2 and 3 4 Ground +5V

4.2.6.3 3. Activity LED Connector

The activity LED connector, designated JP26, is used to indicate the activity status of each SATA drive. The activity LED connector is located on the front panel. For the activity LED header to work properly, connect using a 10-pin LED cable.

Table 4.13: SATA Activity LED Header Pin Definitions

Pin #	Definition	Pin #	Definition
1	ACT IN#0	6	ACT IN#4
2	ACT IN#1	7	ACT IN#5
3	ACT IN#2	8	ACT IN#6
4	ACT IN#3	9	ACT IN#7
5	Ground	10	Empty

4.2.6.4 4 ~ 11. SATA Ports

The SATA ports are used to connect the SATA drive cables. The 8 SATA ports are designated #0 - #7.

4.2.6.5 12. Buzzer Reset

The buzzer reset jumper allows the buzzer to be reset when an alarm has occurred.

4.2.7 Front Jumper Locations and Pin Definitions

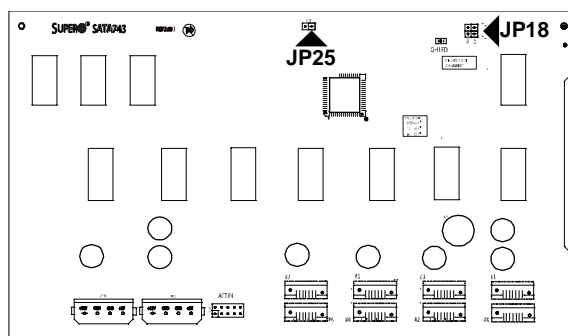

Figure 4.6 Front Jumpers

Table 4.14: Socket Settings

Jumper	Setting	Note
JP18	Open: No Reset (Default) Closed: Reset	Buzzer reset*
JP25	Open: 45°C 1-2: 50°C (Default) 2-3: 55°C	Overheat temperature setting.

4.2.7.1 Explanation of Jumpers

To modify the operation of the backplane, jumpers can be used to choose between optional settings. Jumpers create shorts between two pins to change the function of the connector. Pin 1 is identified with a square solder pad on the printed circuit board.

Note! On two pin jumpers, "Closed" means the jumper is on and "Open" means the jumper is off the pins.

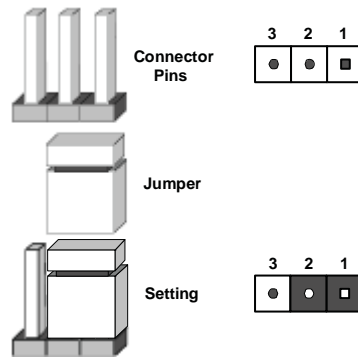

*The buzzer sound indicates that a condition requiring immediate attention has occurred.

The buzzer alarm is triggered by the following conditions:

Hard drive failure

System temperature over 45° Celsius.

4.2.7.2 Front LED Indicator

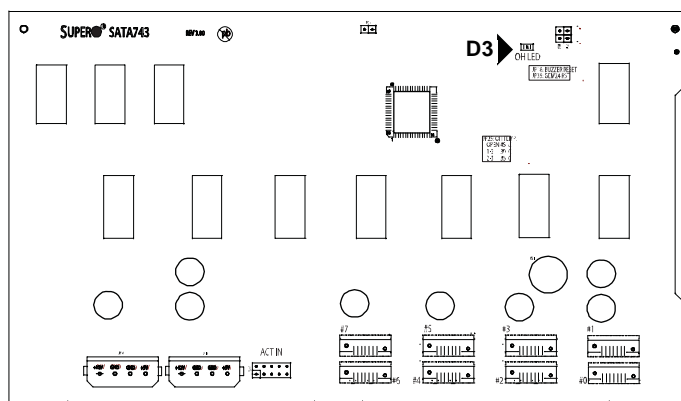

Figure 4.7 Front LEDs

Table 4.15: Front Panel LEDs

LED	State	Specification
D3 OH LED	Off	Red indicator light is on when an overheat condition occurs.

4.2.8 Rear Connectors and LED Indicators Rear Connectors

4.2.8.1 Rear Connectors

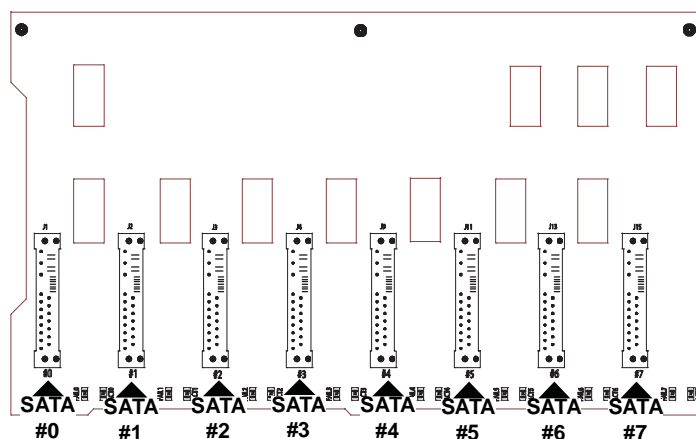

Figure 4.8 Rear Connectors

Table 4.16: Rear SATA Connectors

Rear Connector	SATA Drive Number
SATA #0	SATA HDD #0
SATA #1	SATA HDD #1
SATA #2	SATA HDD #2
SATA #3	SATA HDD #3
SATA #4	SATA HDD #4
SATA #5	SATA HDD #5
SATA #6	SATA HDD #6
SATA #7	SATA HDD #7

4.2.8.2 Rear LEDs

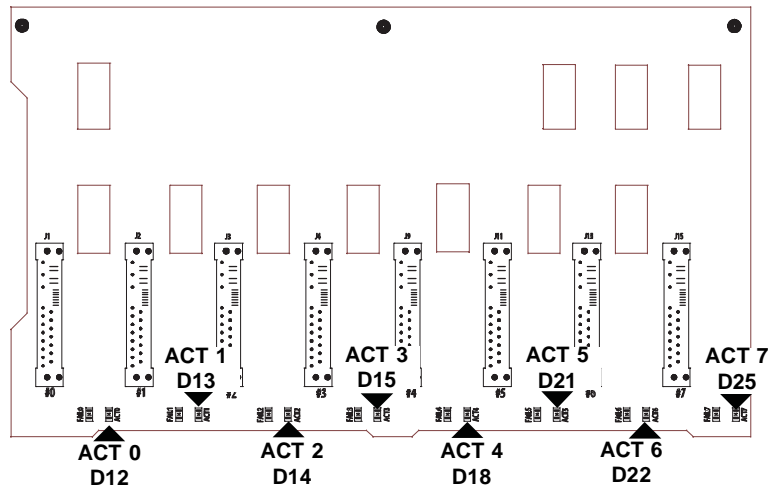

Figure 4.9 Rear LEDs

Table 4.17: Rear LED Indicators

Rear LED	Activity LED	SATA Drive Number
ACT 0	D12	SATA HDD #0
ACT 1	D13	SATA HDD #1
ACT 2	D14	SATA HDD #2
ACT 3	D15	SATA HDD #3
ACT 4	D18	SATA HDD #4
ACT 5	D21	SATA HDD #5
ACT 6	D22	SATA HDD #6
ACT 7	D25	SATA HDD #7

Appendix **A**

Chassis Screws

A.1 Chassis Screws

The accessory box includes all the screws needed to setup your chassis. This section lists and describes the most common screws used. Your chassis may not require all the parts listed.

M/B



Pan head
6-32 x 5 mm
[0.197]

HARD DRIVE



Flat head
6-32 x 5 mm
[0.197]

DVD-ROM, CD-ROM, and FLOPPY DRIVE



Pan head
6-32 x 5 mm
[0.197]



Flat head
6-32 x 5 mm
[0.197]



Round head
M3 x 5 mm
[0.197]



Round head
M2.6 x 5 mm
[0.197]

RAIL



Flat head
M4 x 4 mm
[0.157]



Round head
M4 x 4 mm
[0.157]



Flat head
M5 x 12 mm [0.472]
Washer for M5



M/B STANDOFFS



M/B standoff
6-32 to 6-32



M/B (CPU)
standoff
M5 to 6-32

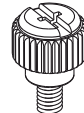

Thumb screw
6-32 x 5 mm
[0.197]



1/U M/B standoff
6-32 x 5 mm
[0.197]



ADVANTECH

Enabling an Intelligent Planet

www.advantech.com

Please verify specifications before quoting. This guide is intended for reference purposes only.

All product specifications are subject to change without notice.

No part of this publication may be reproduced in any form or by any means, electronic, photocopying, recording or otherwise, without prior written permission of the publisher.

All brand and product names are trademarks or registered trademarks of their respective companies.

© Advantech Co., Ltd. 2011