

10.1" ~ 21.5" Extended Temperature High Brightness Panel PC



Extended Temperature High Brightness

- Fanless Operation; Intel® Pentium™ N4200 CPU
- High Brightness Sunlight Readable (1000 Nits) Optically Bonded TFT LCD
- Extended Temperature (-20~60°C)
- IP66 Rated Aluminum Bezel for Washdown Environments
- Microsoft Windows® 10 IoT 2019 OS

System	CPU	Intel® Pentium™ Apollo Lake™ N4200 Quad-Core 1.1GHz Processor			
	System Chipset	SoC			
	System Memory	Onboard DDR3L 4 GB 1600 MHz			
I/O Ports	USB	2 x USB 3.0 type A			
	Serial	1 x RS-232/422/485 DE-9P, COM1 (default RS-232) 1 x RS-232 DE-9P, COM2			
	Audio	1 x 3.5 mm line out			
	LAN	2 x GbE RJ-45			
	Power	3-pin connector header, DC power input			
	Remote Power Switch	2-pin connector header			
	Expansion	Expansion Slot	Optional Wi-Fi kit (IEEE 802.11a/b/g/n/ac card and antenna)		
Touch Screen	Type	Projected Capacitive Touch			
	Interface	USB			
	Light Transmission	90+%			
Display	Optical Bonding	Yes			
	Display Type	10.1" WXGA TFT LCD	12.1" SVGA TFT LCD	15.0" XGA TFT LCD	21.5" FHD TFT LCD
	Max. Resolution	1280 x 800	800 x 600	1024 x 768	1920 x 1080
	Max. Color	16.7M	16.2M	16.7M	16.7M
	Luminance (cd/m ²)	1000	1000	1000	1000
	View Angle (H°/V°)	170/170	178/178	160/150	178/178
	Contrast Ratio	1000:1	700:1	800:1	3000:1
	Backlight Lifetime (hours)	50,000+	50,000+	50,000+	50,000+
Storage	Solid State Drive Type	1 x 2.5" SATA III, MLC			
	Solid State Drive Capacity	64, 128, 256 GB SSD			
	SD Card Slot	1 x internal micro Secure Digital memory card socket, up to 32 GB			
Electrical	Input Voltage	9-36 VDC	9-36 VDC	9-36 VDC	9-36 VDC
	Input Current	0.74-2.97 A	1.18-4.71 A	0.93-3.7 A	1.18-4.73 A
	Input Power (max.)	26.7 W	42.4 W	33.3 W	42.6 W
Mechanical	Dimensions (W x H x D)	11.22 x 7.44 x 1.93" [285 x 189 x 48.9 mm]	12.56 x 9.65 x 2.03" [319 x 245 x 51.7 mm]	16.14 x 12.20 x 2.15" [410 x 310 x 54.67 mm]	21.94 x 14.26 x 2.56" [557.3 x 362.3 x 64.8 mm]
	Net Weight	~ 4.19 lbs [1.9 kg]	~ 6.2 lbs [2.8 kg]	~ 10.14 lbs [4.6 kg]	~ 16.53 lbs [7.5 kg]
	Panel Cutout Dimensions (W x H)	10.71 x 6.93" [272 x 176 mm]	11.93 x 9.02" [303 x 229 mm]	15.43 x 11.50" [392 x 292 mm]	21.22 x 13.54" [539 x 344 mm]
	Mounting	Panel mounting, VESA 100 x 100 mm	Panel mounting, VESA 100 x 100 mm	Panel mounting, VESA 100 x 100 mm	Panel mounting, VESA 100 x 100 mm
	Construction	Silver aluminum front bezel and chassis			
Environmental	Operating Temperature	-4~140°F [-20~60°C]			
	Storage Temperature	-22~158°F [-30~70°C]			
	Relative Humidity	10 to 95% @ 40°C, non-condensing			
	Rating	IP66 / NEMA 4 when panel mounted			
Operating System	Certification	cULus / CE / FCC Class A / RoHS			
	Microsoft Windows® Options	Microsoft Windows® 10 IoT Enterprise Embedded 2019 LTSC 64-bit (EPKEA) Microsoft Windows® 10 IoT Enterprise 2019 LTSC 64-bit (PKEA)			
	Linux® Options	Linux® Ubuntu Desktop 22.04			
Notes	Specifications subject to change without notice				

OMI6810

Dimensions are in inches [mm]

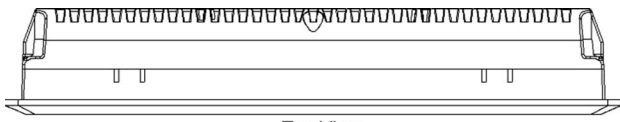

Top View

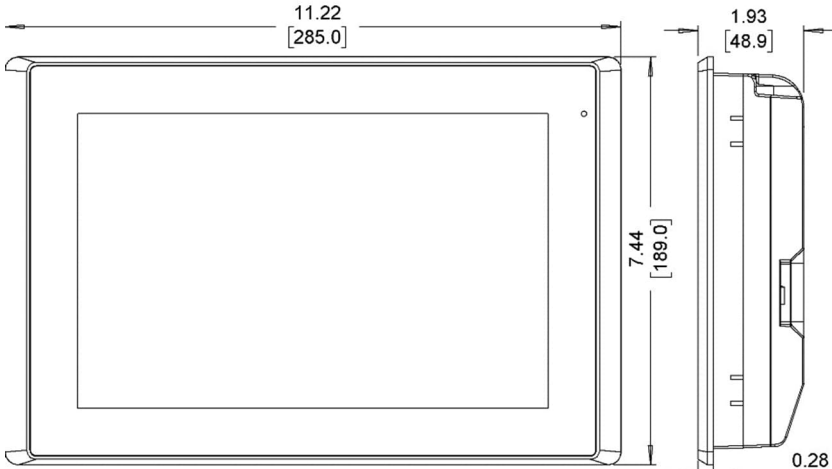

Front View

Side View

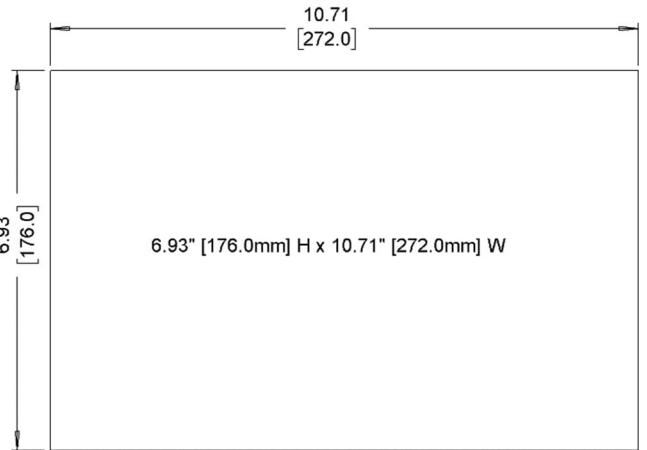

Cutout Dimensions

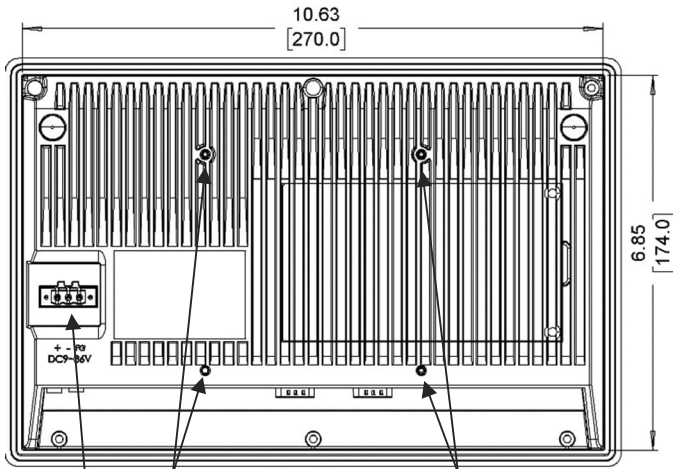

Rear View

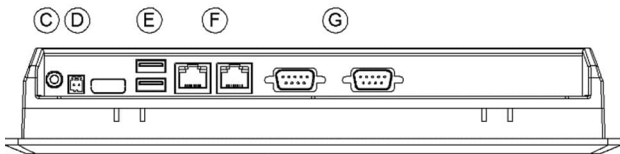

Bottom view

- A Power Connector
- B VESA 100 x 100 mm Screw Holes
- C Line Out
- D Remote Power Switch Connector
- E USB 3.0 Host Ports
- F Gigabit Ethernet Ports
- G DE9P COM Ports

OMI6812

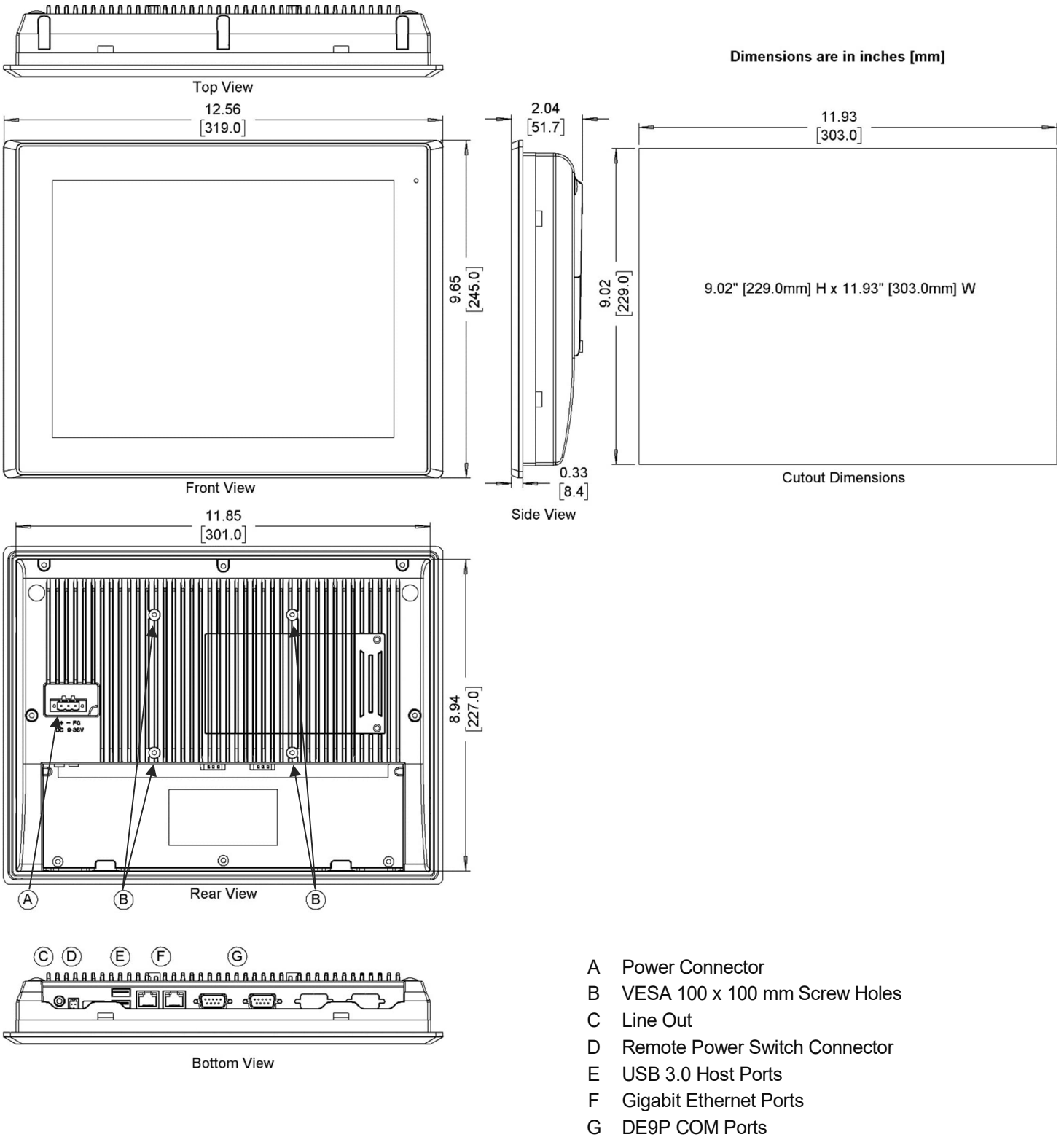

OMI6815

Dimensions are in inches [mm]

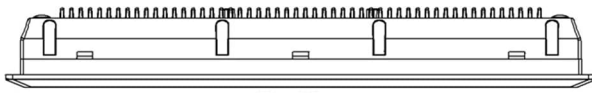

Top View

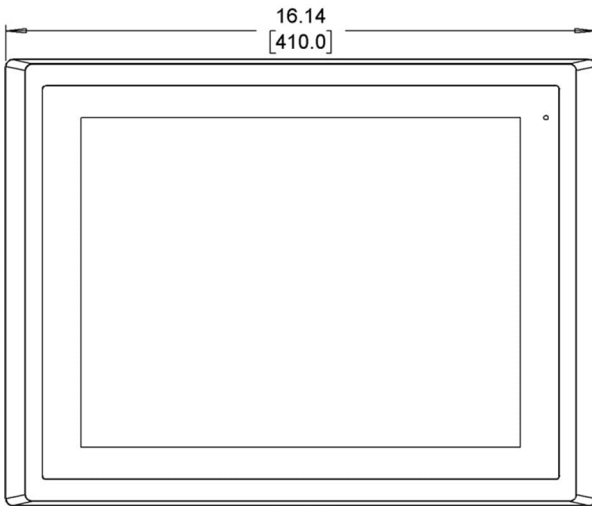

Front View

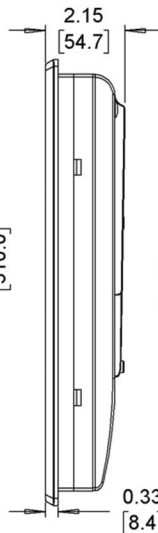

Side View

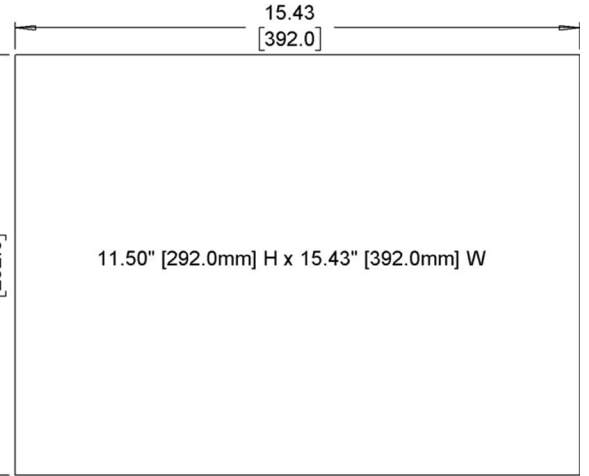

Cutout Dimensions

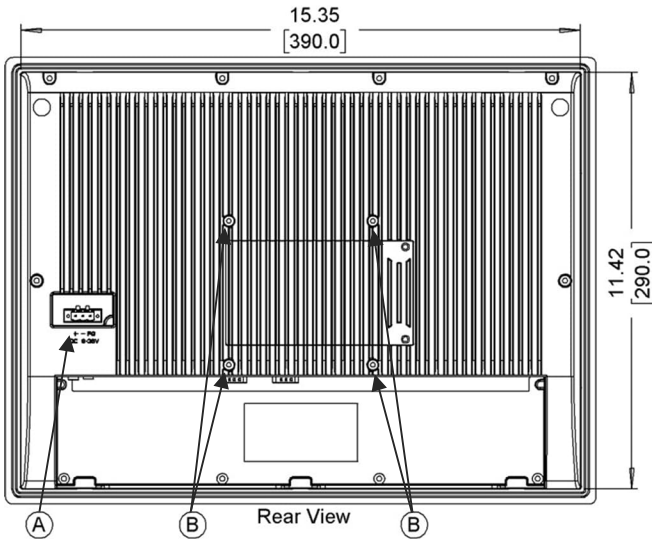

Rear View

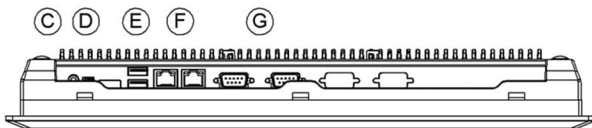

Bottom View

- A Power Connector
- B VESA 100 x 100 mm Screw Holes
- C Line Out
- D Remote Power Switch Connector
- E USB 3.0 Host Ports
- F Gigabit Ethernet Ports
- G DE9P COM Ports

OMI6821

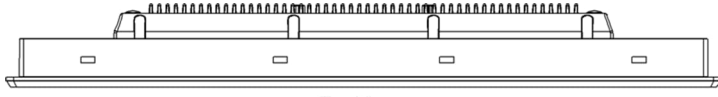

Top View

21.94
[557.3]

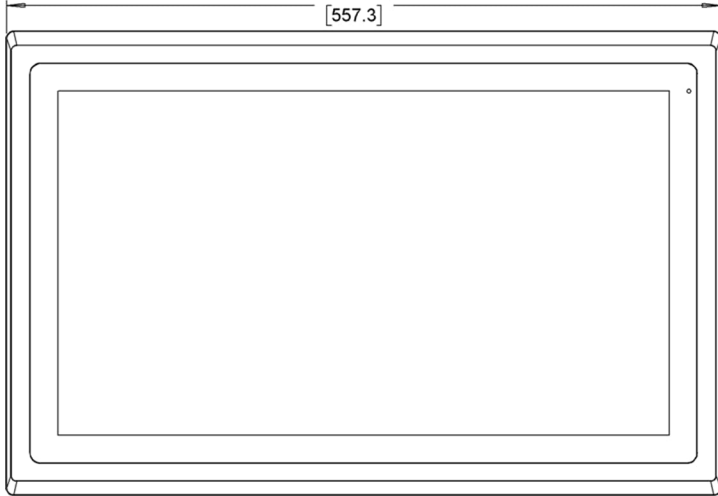

Front View

14.26
[362.3]

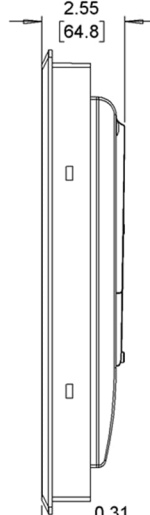

Side View

2.55
[64.8]

0.31
[8.0]

Dimensions are in inches [mm]

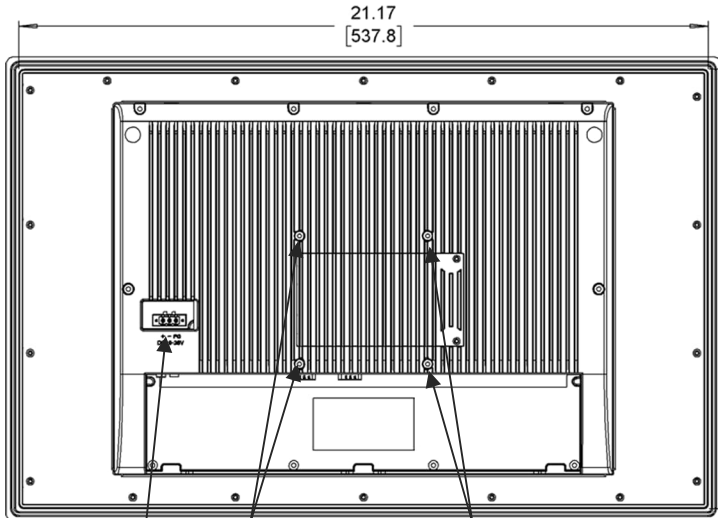

Rear View

21.17
[537.8]

13.48
[342.4]

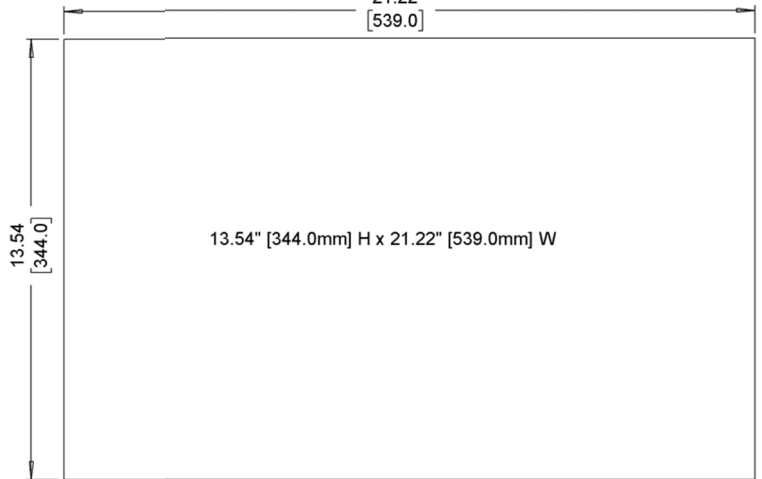

13.54" [344.0mm] H x 21.22" [539.0mm] W

Cutout Dimensions

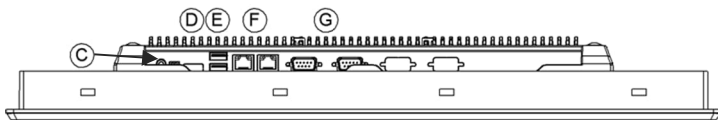

Bottom View

- A Power Connector
- B VESA 100 x 100 mm Screw Holes
- C Line Out
- D Remote Power Switch Connector
- E USB 3.0 Host Ports
- F Gigabit Ethernet Ports
- G DE9P COM Ports

Why Buy A Maple Industrial PC

In addition to our powerful and affordable hardware, we'll also continue to support your company long after a sale. Wide product selection, large in-stock inventory, outstanding product warranty, free technical support and software, and in-house repairs with quick turnaround times, Maple Systems has your business covered.



Customize To Meet Your Needs

Companies have chosen Maple Systems solutions over Allen-Bradley, Omron, Siemens, Panasonic, and so many others, in hundreds of applications, in every industry, and in every type of organization. Our Industrial PCs are designed to resolve your toughest automation challenges in manufacturing, processing, and fabrication environments, and because we offer thousands of different configurations, designing your IPC to meet your unique requirements is easy.

All our Industrial PCs are ideal for applications in industrial automation, healthcare, manufacturing, oil & gas, packaging, building automation, water, energy, agriculture, food & beverage, and more. Our offerings include [high brightness/sunlight readable displays](#), [extended temperature IPCs](#), [stainless steel enclosures](#), and [Class I, Div 2 certified IPCs](#). Learn more about the [industries we serve](#) and discover why more and more companies are choosing Maple Systems.

Supports Your 3rd Party Software

Since our Industrial PCs can be configured with either a Windows™ or [Linux™](#) Operating System, adding your own software is easy. Don't be tied to expensive industrial computers or HMIs just because of a name. Our IPCs support FactoryTalk®, Ignition SCADA®, Emerson Ovation®, Simatic SCADA®, Predator Touch HMI®, and hundreds of other HMI and SCADA software solutions.

We are a proud partner of Award-winning AVEVA™ Edge 2020. This powerful HMI/SCADA software package enables you to create custom industrial control applications for your unique industry, putting you in the driver's seat of creating your industrial process. With easy-to-use commands/tool bars and a Microsoft Windows® programming environment, AVEVA™ Edge 2020's feature-rich application puts you in the driver's seat of creating your industrial process. Learn more about [AVEVA Edge 2020](#).

Build your SCADA

We offer all the components you need to create your own unique level of supervisory data acquisition and control, from the simplest stand-alone machine to sophisticated multi-device networked production line(s), all the way to enterprise-level operations and IIoT functionalities leveraging cloud connectivity.

Our products can help you standardize communications between devices, gluing different systems together for one source to your SCADA. No need to redesign your entire application. Keep the components that are already working for you, just add Maple Systems components to grow your abilities to supervise, control, and acquire data.

[Application Story](#)

Pharmaceutical Equipment

Adding a Maple Systems [Stainless Steel Industrial Panel PC](#) with Wi Fi to an existing machine saved this OEM time and money

This OEM manufacturer uses a Maple Systems Industrial Panel PC for their production-series tablet pressing machines. The rotary tablet press boasts features essential for successful mid-sized tableting without the full-scale price. This application required a cost effective 12" panel touch screen industrial PC with enough computing power for their custom software and reporting system. They also required the front bezel be stainless steel with a IP69K rating to meet washdown sanitization requirements. See how we support the [Pharmaceutical and Medical Industry](#).

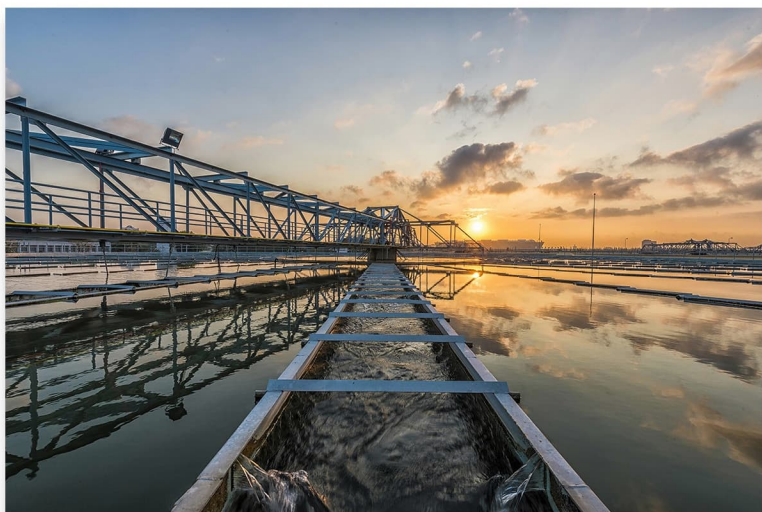

[Case Study](#)

Water / Wastewater Treatment

Our [High Brightness Industrial Panel PC](#) with Wi-Fi checked all the boxes for this System Integrator

During their large revamping of a utility control system, Aqua Sierra's customer North Tahoe Utilities needed a PC-based HMI to run a simple Wonderware SCADA project as an interface. The PC needed to allow 3rd party software logging and reporting tools for their utility management system. The control room facility is climate controlled with large windows and bright overhead lighting. The remote facility did not have Ethernet cabling out to the PC location, however there was a Wi-Fi router connection nearby. Read how we support the [Water & Wastewater industry](#).

[Application Story](#)

Dairy / Agriculture Equipment

The [Stainless Steel enclosure](#) makes this Industrial Panel PC the right choice for the food and beverage industry

This customer is a leading OEM manufacturer of custom stainless steel processing equipment and a preferred provider of quality products and services to the cheese, dairy, food, beverage and other sanitary industries. The customer's dairy processing equipment required an IPC that operators can interface with while wearing gloves. Another major requirement is that the PC be IP69K washdown rated to endure the regular cleaning and disinfecting required; and for compliance and record keeping, the customer needed real time data logging and storage using a 3rd party historian application running on the PC. Read more about the [Food & Beverage OEMs](#) we support everyday.

