

1 2 3 4 5 6

A

B

C

D

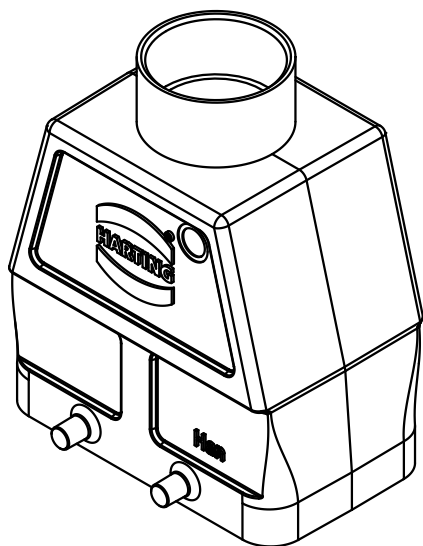
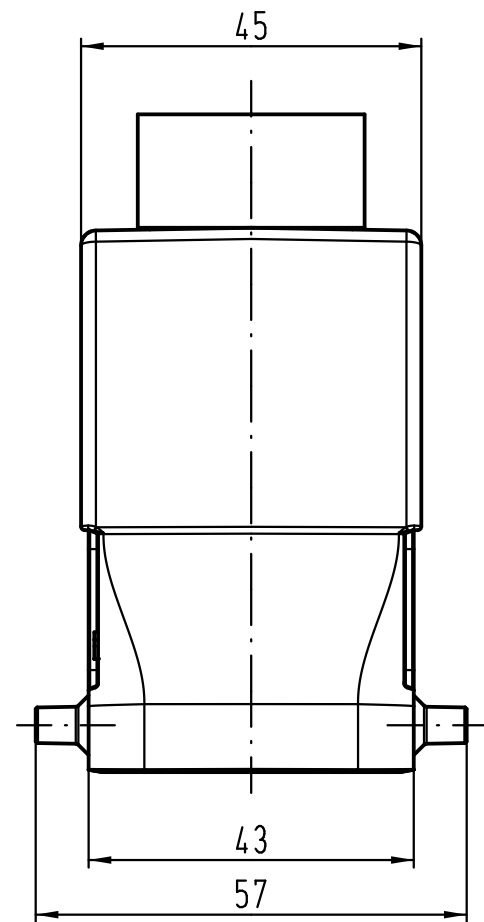
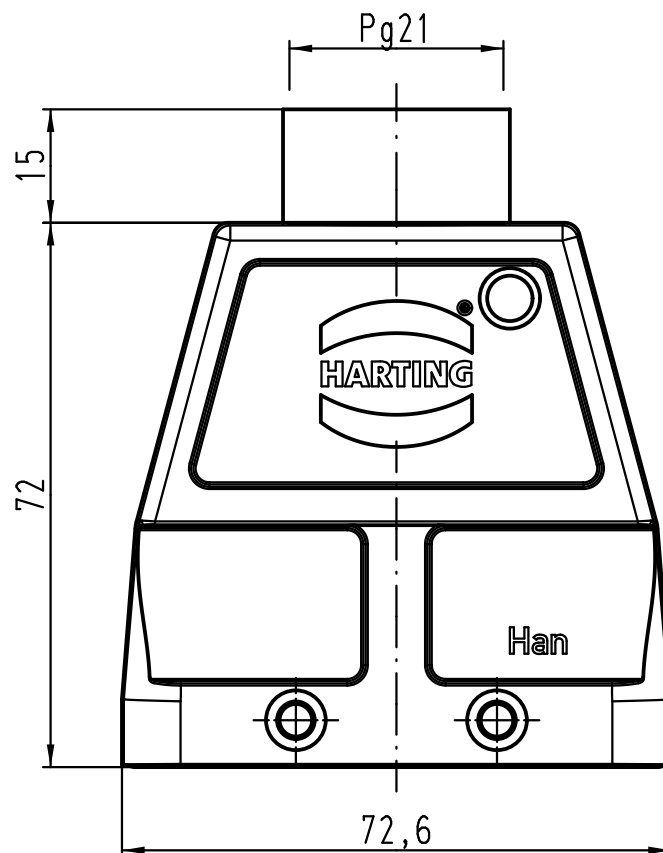

All Dimensions in mm Original Size DIN A 4			Techn. Character.			Nicht tolerierte Maße! Free size tolerances			
				Dat.	Name	Maßstab/Scale 1:1	Han 10B-gg-21 Gehäuse/hood		
			Detail.	19.03.12	Ho				
			Insp.		Be				
			Stand.						
A			HARTING Electric GmbH & Co. KG				TB 09 30 010 0422		Blatt/page
Mod.	Dat.	Name	D-32339 Espelkamp						