

DETAILS

Product Number	C13557_BRIDGET-S-UNI
Family	Bridget
Type	Reflector
Color	metal
Diameter	22,6 mm
Height	12,8 mm
Style	hexag
Optic Material	PC
Holder Material	
Fastening	glue
Status	production ready
ROHS Compliant	Yes
Date Updated	11/12/2015



OPTICAL PROPERTIES

LED	Viewing	Light	Effi-		Connector
	Angle	Beam	ciency	cd/lm	
BXRA ES Star	35 deg	Spot	86 %	1.300	-
CLL02x/CLU02x (LES10)	44 deg	Spot	85 %	1.100	-
CLU700/701	26 deg	Spot	87 %	1.900	-
CXA/B 15xx	39 deg	Spot	87 %	1.300	-
XP-L HI	14 deg	Spot	90 %	5.000	-
CXM-9	45 deg	Spot	87 %	1.100	-
Soleriq P6	28 deg	Spot	82 %	1.940	-
Soleriq P9	39 deg	Spot	86 %	1.230	-
Soleriq S9	sim: 42	Spot	sim: 89 %	sim: 1.100	-
COB D Series LES 9.8 mm	44 deg	Spot	88 %	1.100	-
Mini Zenigata (GW5BM)	42 deg	Spot	87 %	1.200	-
SLE G5 LES6	24 deg	Spot	88 %	2.200	-
SLE G5 LES11	48 deg	Spot	84 %	0.990	-

Relative intensity of C13557_BRIDGET-S-UNI_(XP-L_HI)

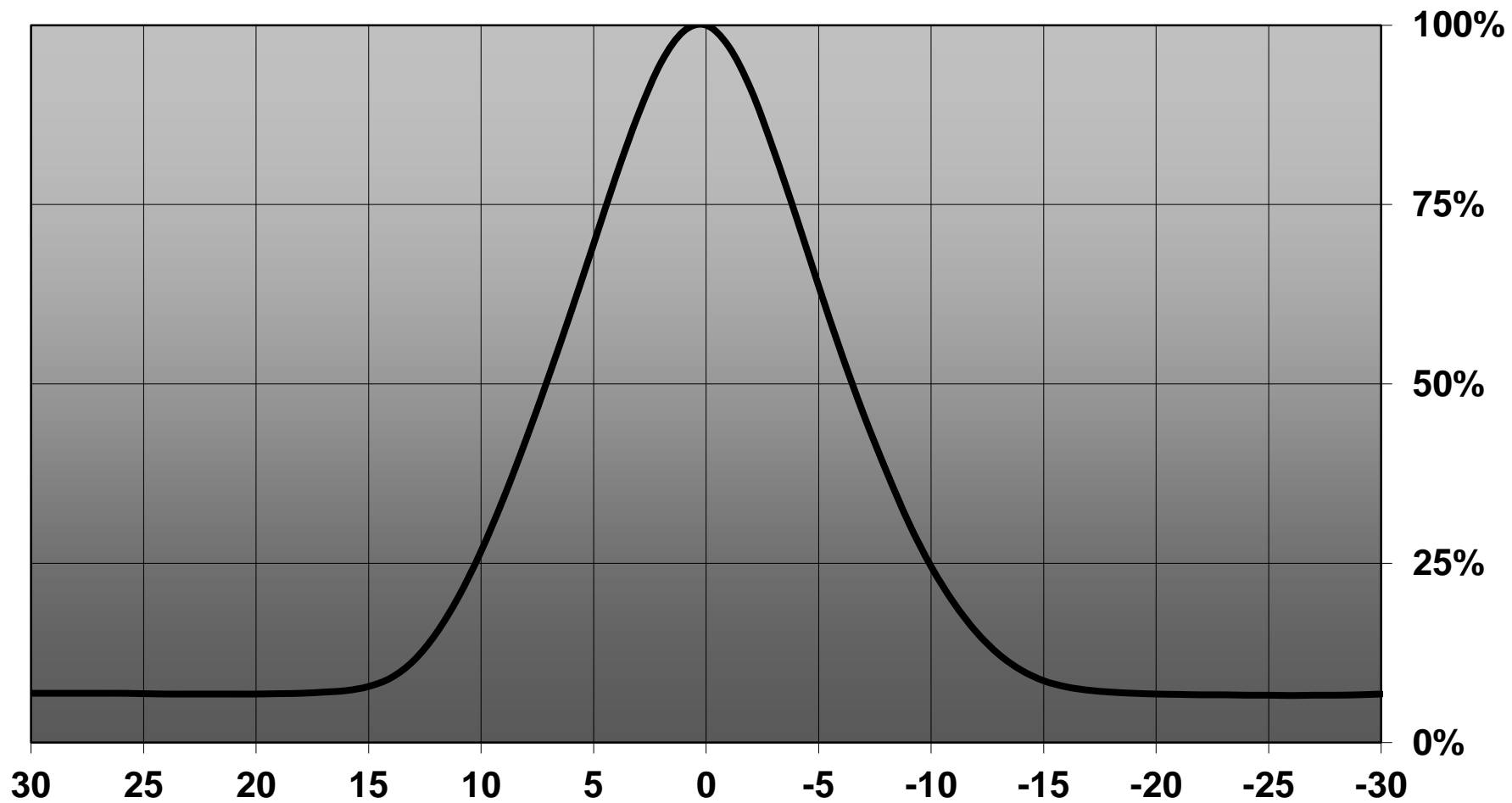

Relative intensity of C13557_BRIDGET-S-UNI_(Soleriq P6)

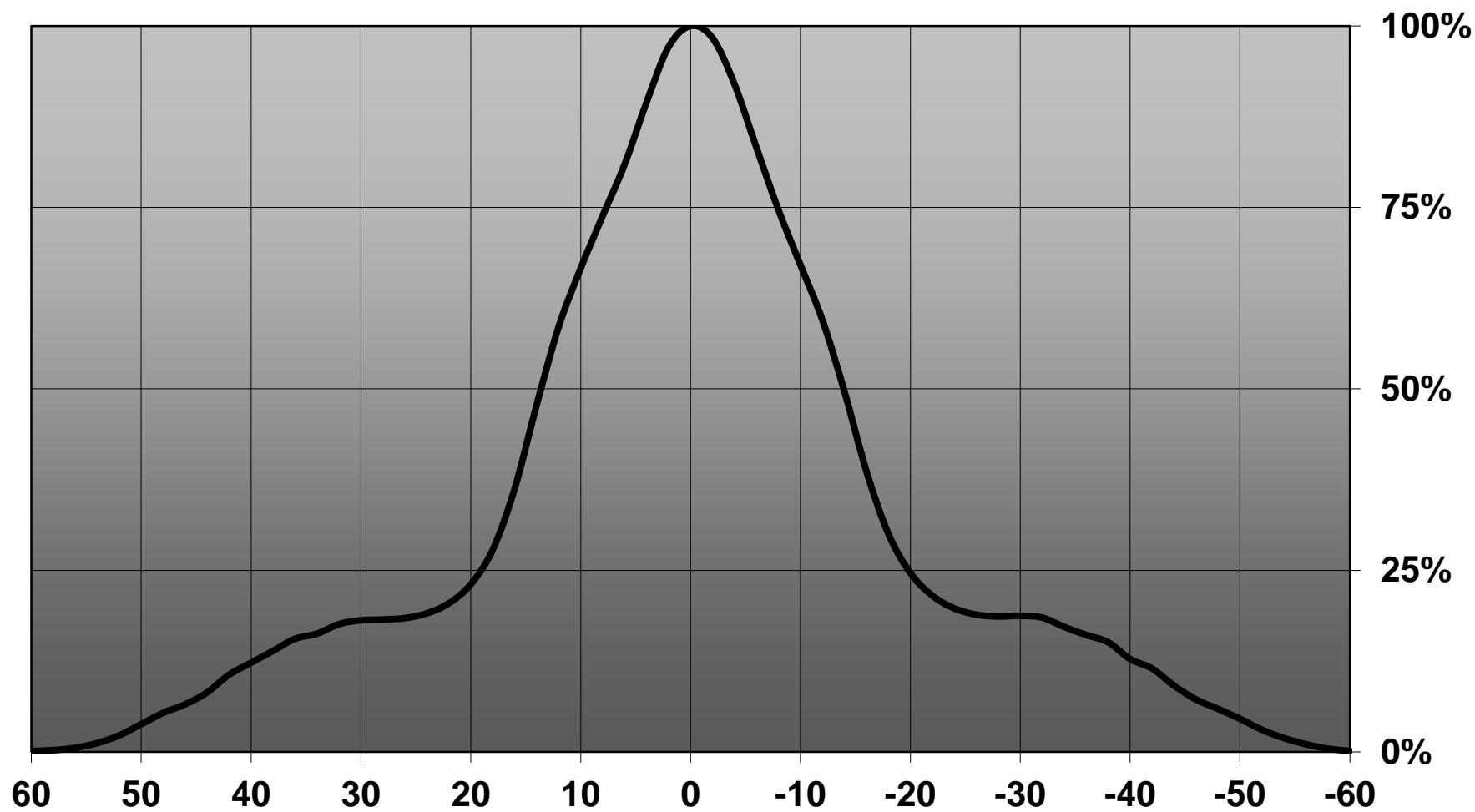

Relative intensity of C13557_BRIDGET-S-UNI_(Soleriq P9)

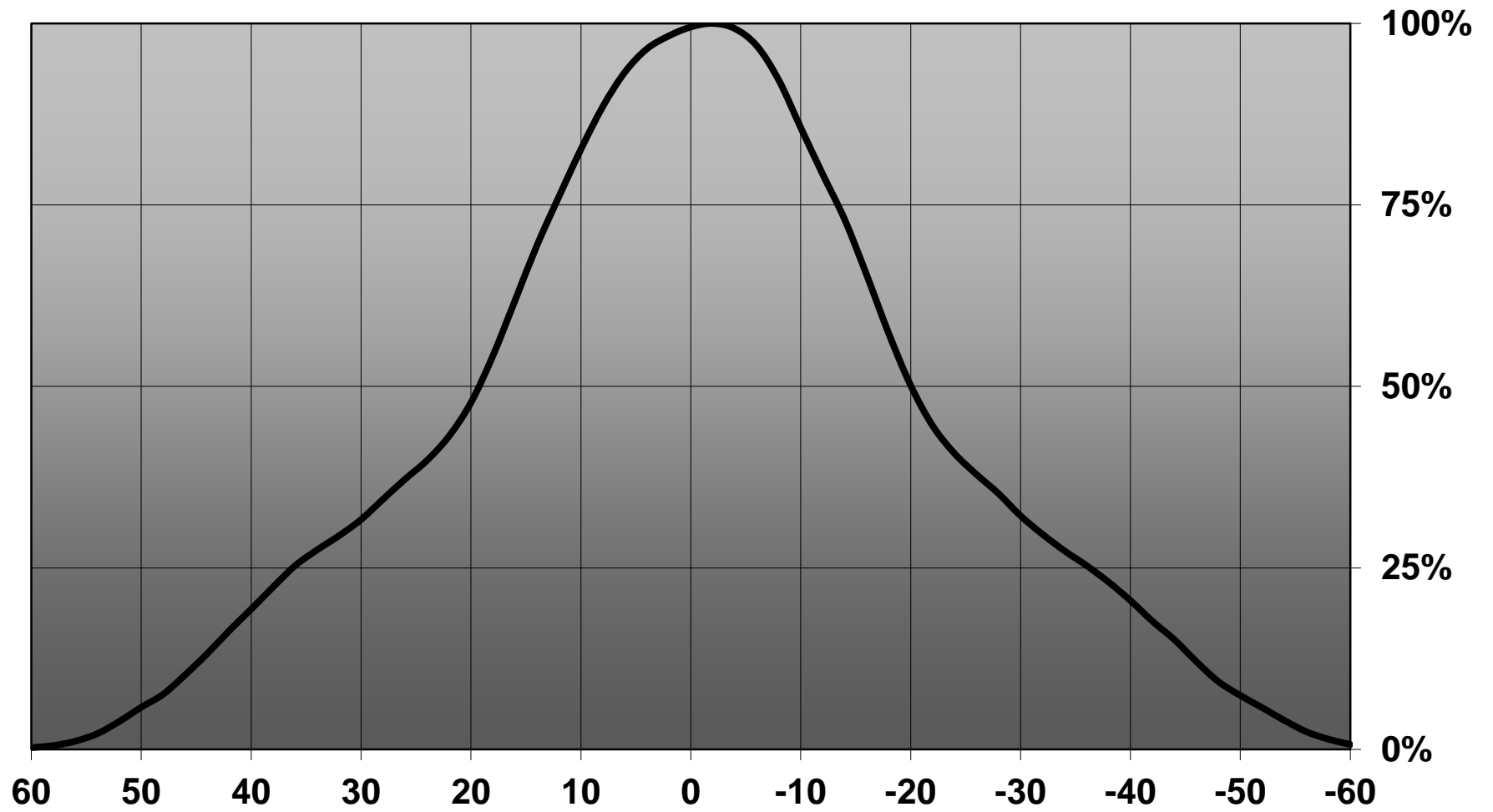

D

C

B

A

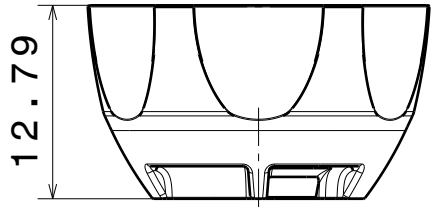

Front view

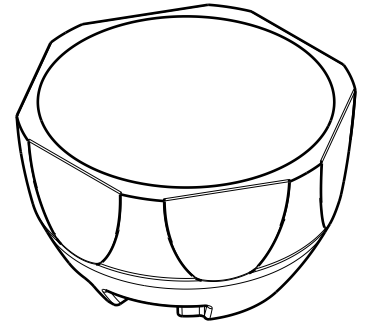

Isometric view

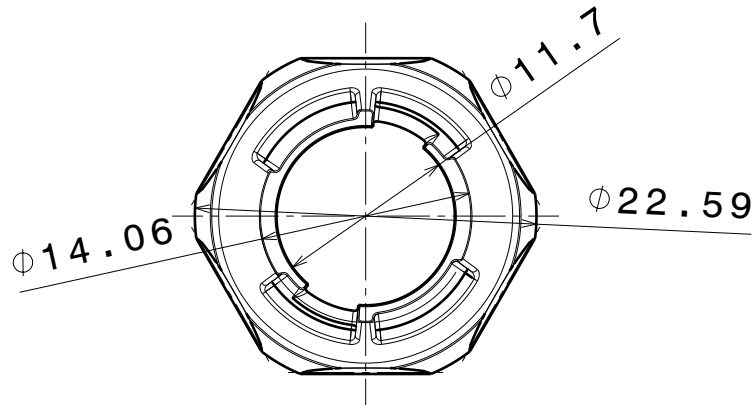

Bottom view

Tolerances if not otherwise shown
 According to DIN ISO 2768-1
 Linear measures:
 Up to 30mm class M, otherwise class C.
 According to DIN ISO 2768-2
 Form and position: class L



Ledil Oy
 Salorankatu 10
 FIN 24240 SALO
 Finland

THIRD ANGLE PROJECTION:

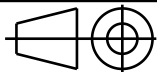

DRAWING TITLE

BRIDGET_UNI_Datasheet

This drawing is the property
 of LEDiL Oy. It may not be
 reproduced, copied or
 communicated without a written
 agreement with LEDiL Oy."

SIZE	PART NUMBER
A4	-

SCALE	2:1	WEIGHT	-
-------	-----	--------	---

SHEET	1/1
-------	-----

D

A

Luminaire: LEDil Oy C13557_BRIDGET-S-UNI_(BXRA_ES_STAR) Efficiency=86%
Lamps: 1 x Bridgelux BXRA ES Star (C0402) 203lm @ 250mA CCT=7300K P=2.2W I=250mA

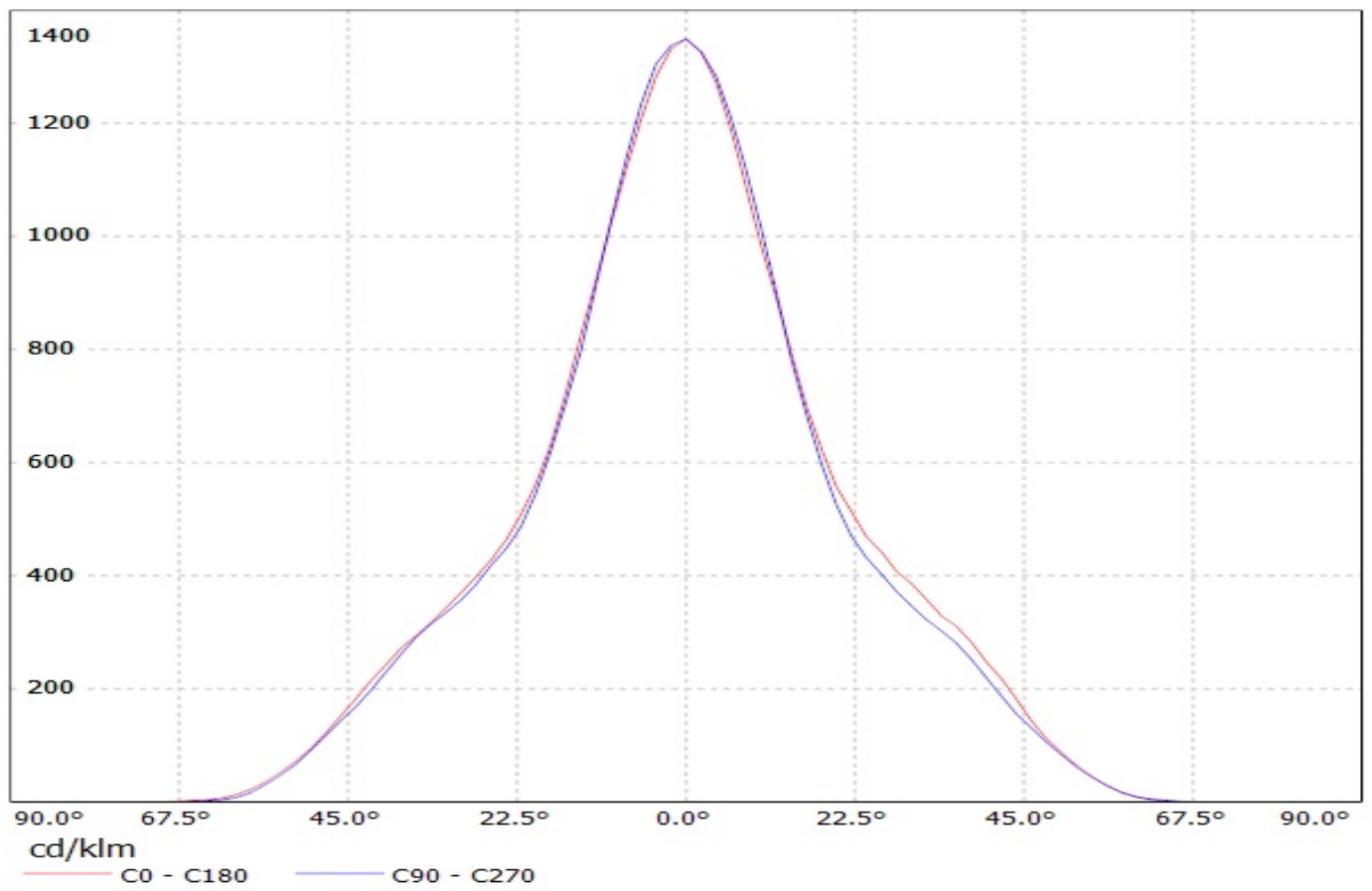

Luminaire: LEDil Oy C13557_BRIDGET-S-UNI_(CLL020) Efficiency=85%
Lamps: 1 x Citizen CLL020 (CLL020-1202A5-303H1A7) 515lm @ 250mA CCT=3000K P=9.3W I=250mA

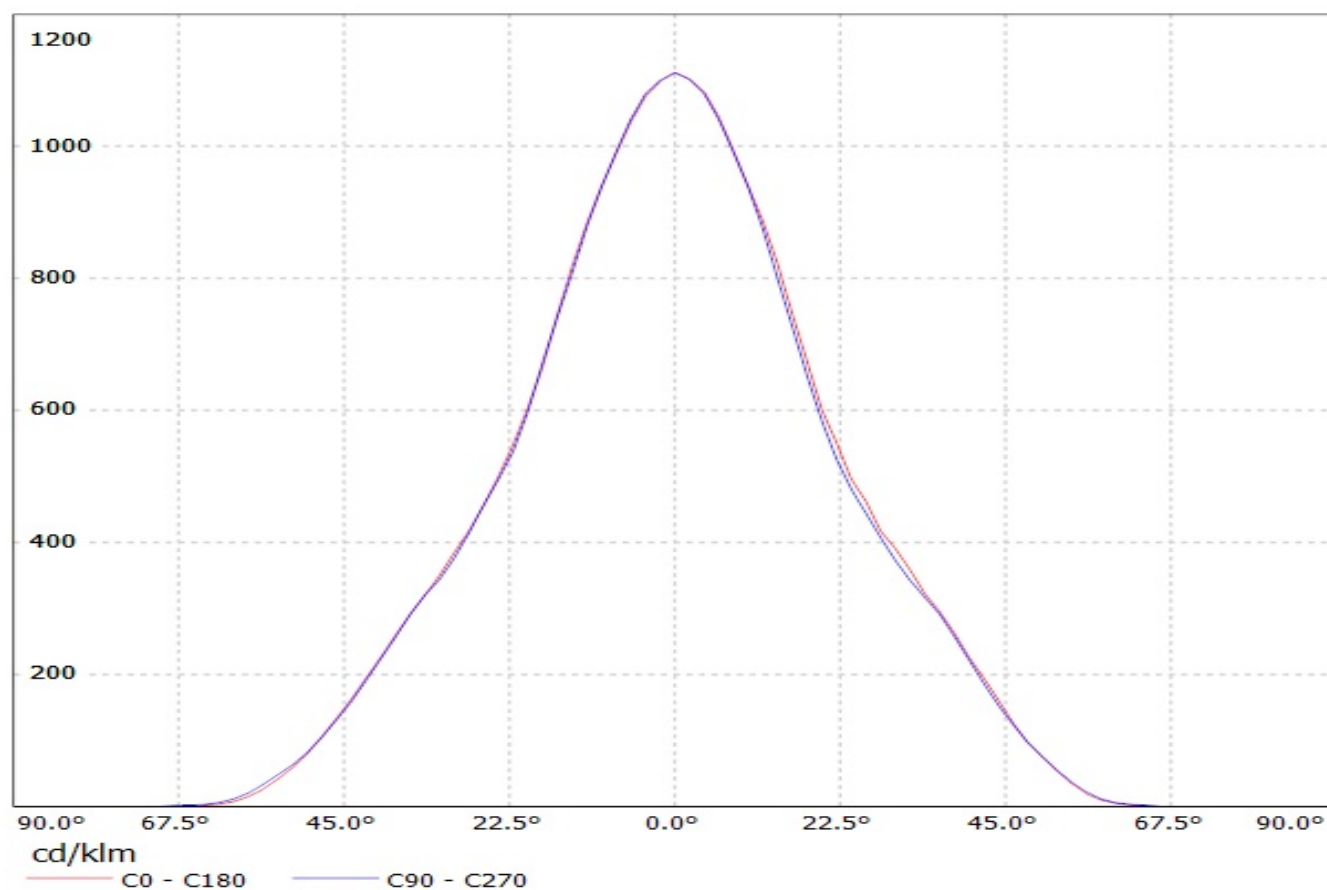

Luminaire: Ledil C13557_BRIDGET-S-UNI_(CLU700)
Lamps: 1 x Citizen_CLU700_394.637lm@100mA_P=2.8W_I=0.10A

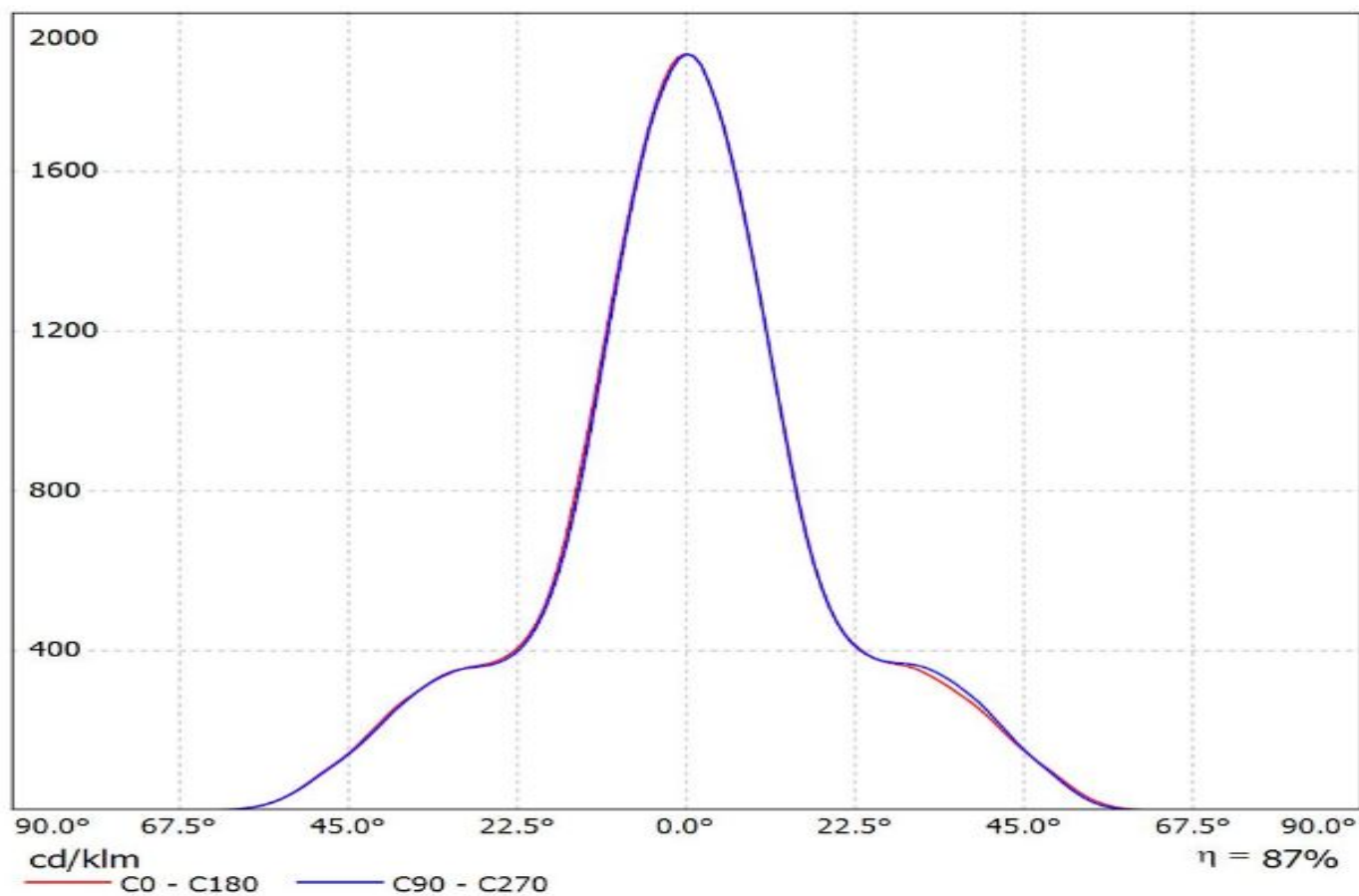

Luminaire: LEDil Oy C13557_BRIDGET-S-UNI_(CXA15) Efficiency=87%
Lamps: 1 x Cree CXA15 (CXA1507-30F-F2-N0A-00000) 218lm @ 250mA CCT=3100K P=1.7W I=250mA

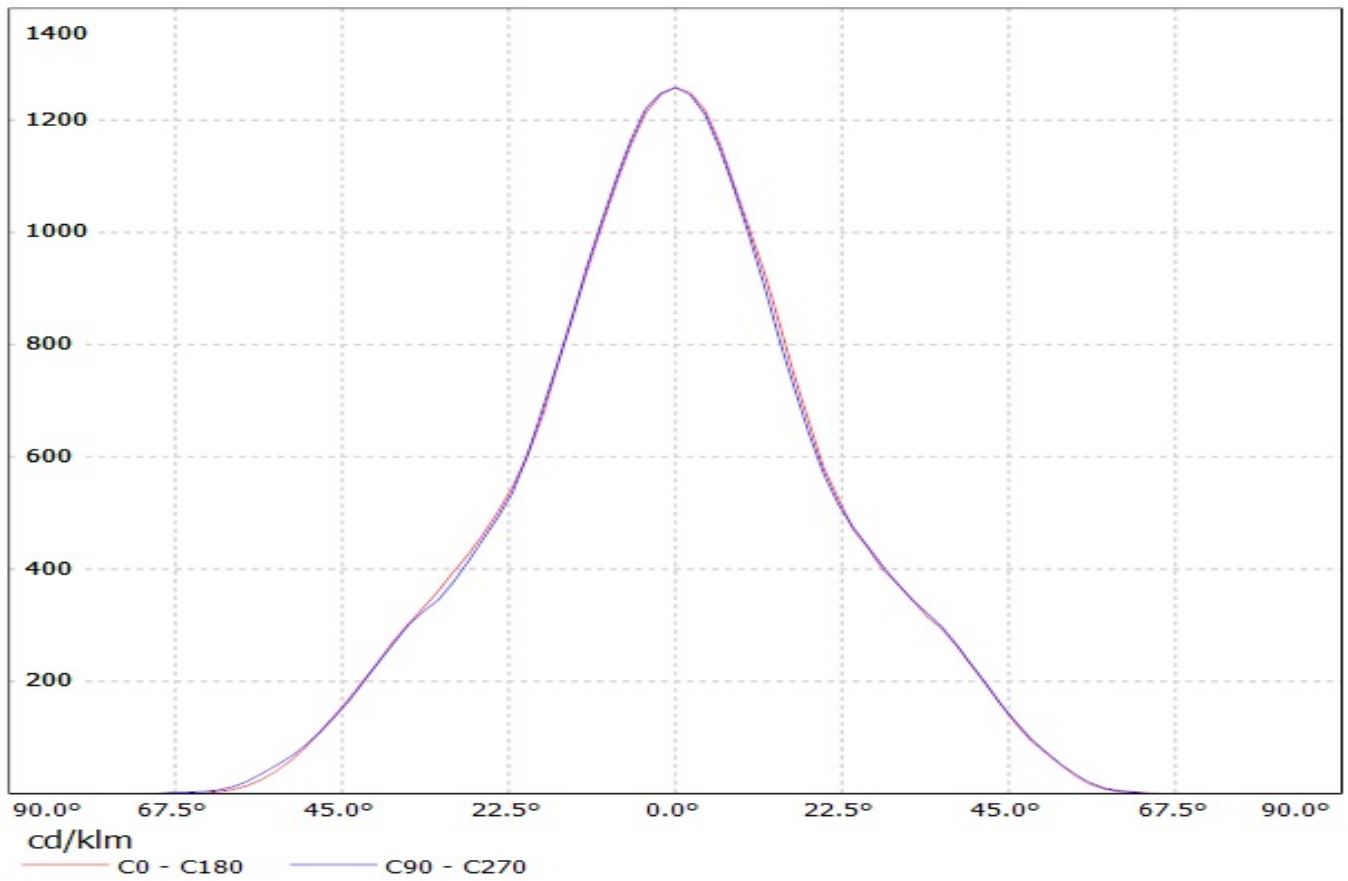

Luminaire: LEDiL Oy C13557_BRIDGET-S-UNI_(CXM-9)

Lamps: 1 x Luminus_XNOVA_CXM-9_(AA00)_977.302lm@240mA_P=8.28264W_I=240mA

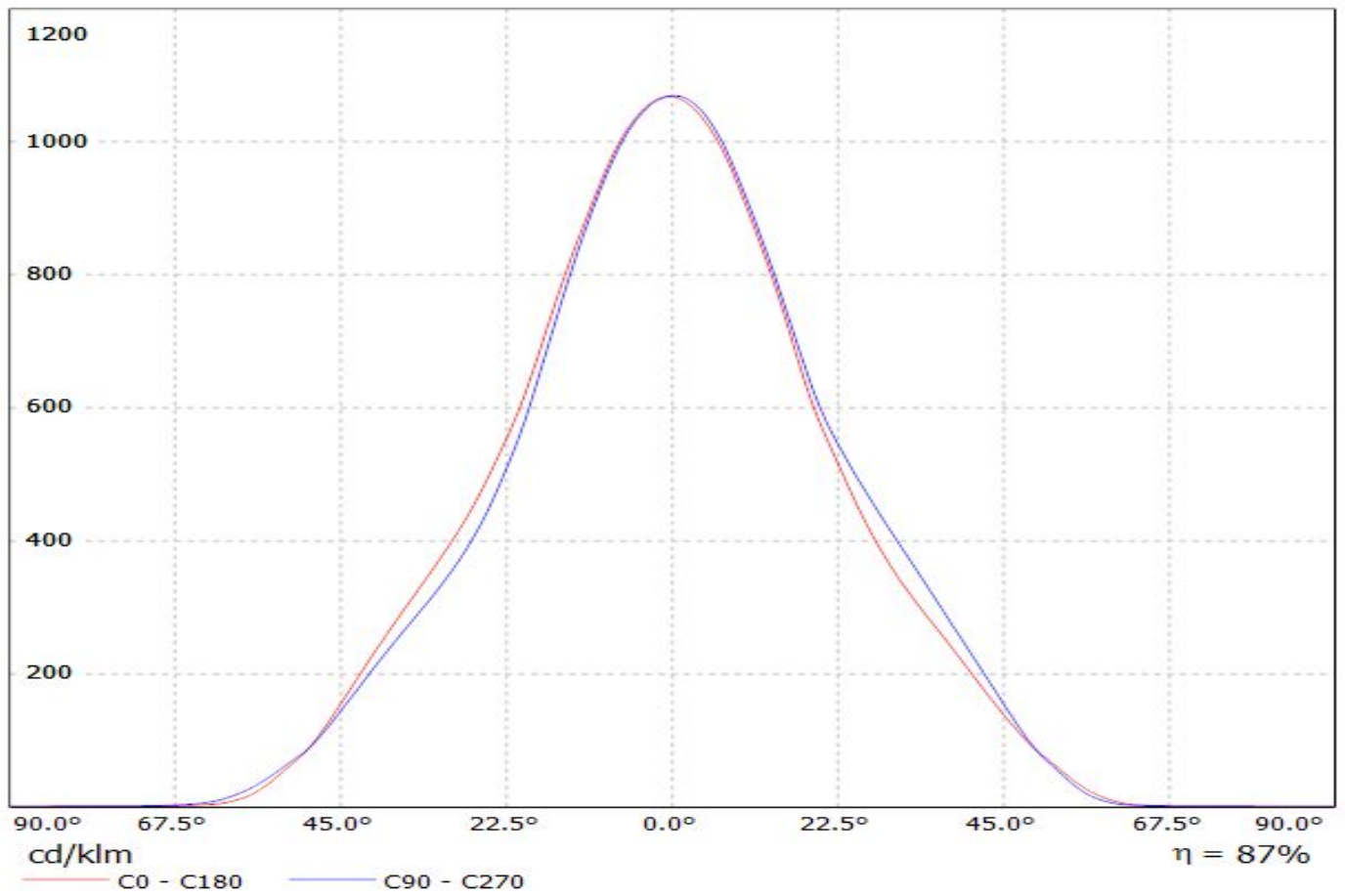

Luminaire: Ledil Oy C13557_BRIDGET-S-UNI_(Soleriq_S9)_SIMULATED
Lamps: 1 x Osram Soleriq S9 (GW KAFJB3.EM)

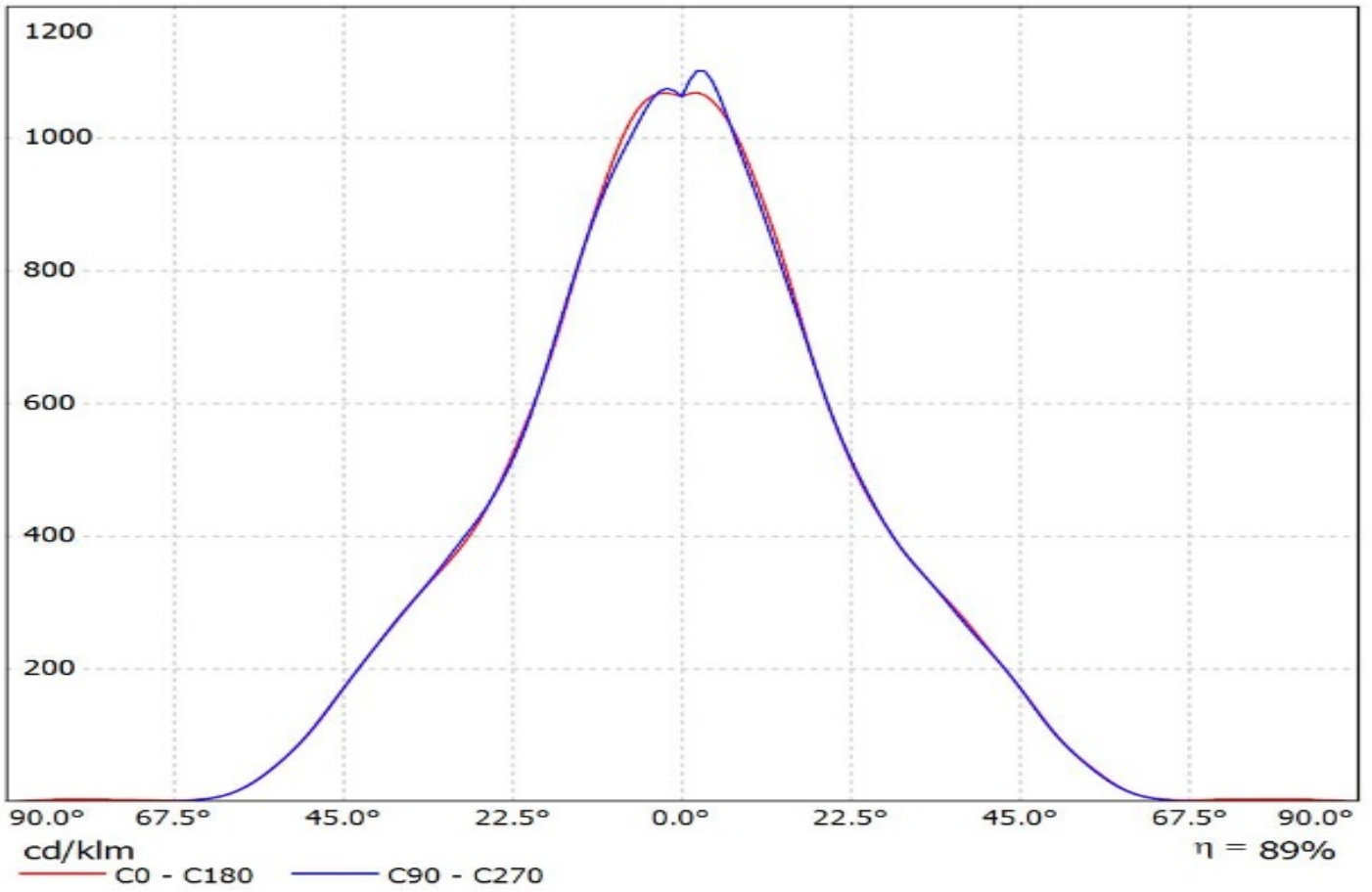

Luminaire: LEDiL Oy C13557_BRIDGET-S-UNI_(COB_D_LES_9.8mm)

Lamps: 1 x Samsung_COB_D_series_LES_9.8mm_LC013D_534.999lm@100mA_P=3.1948W_I=0.100A

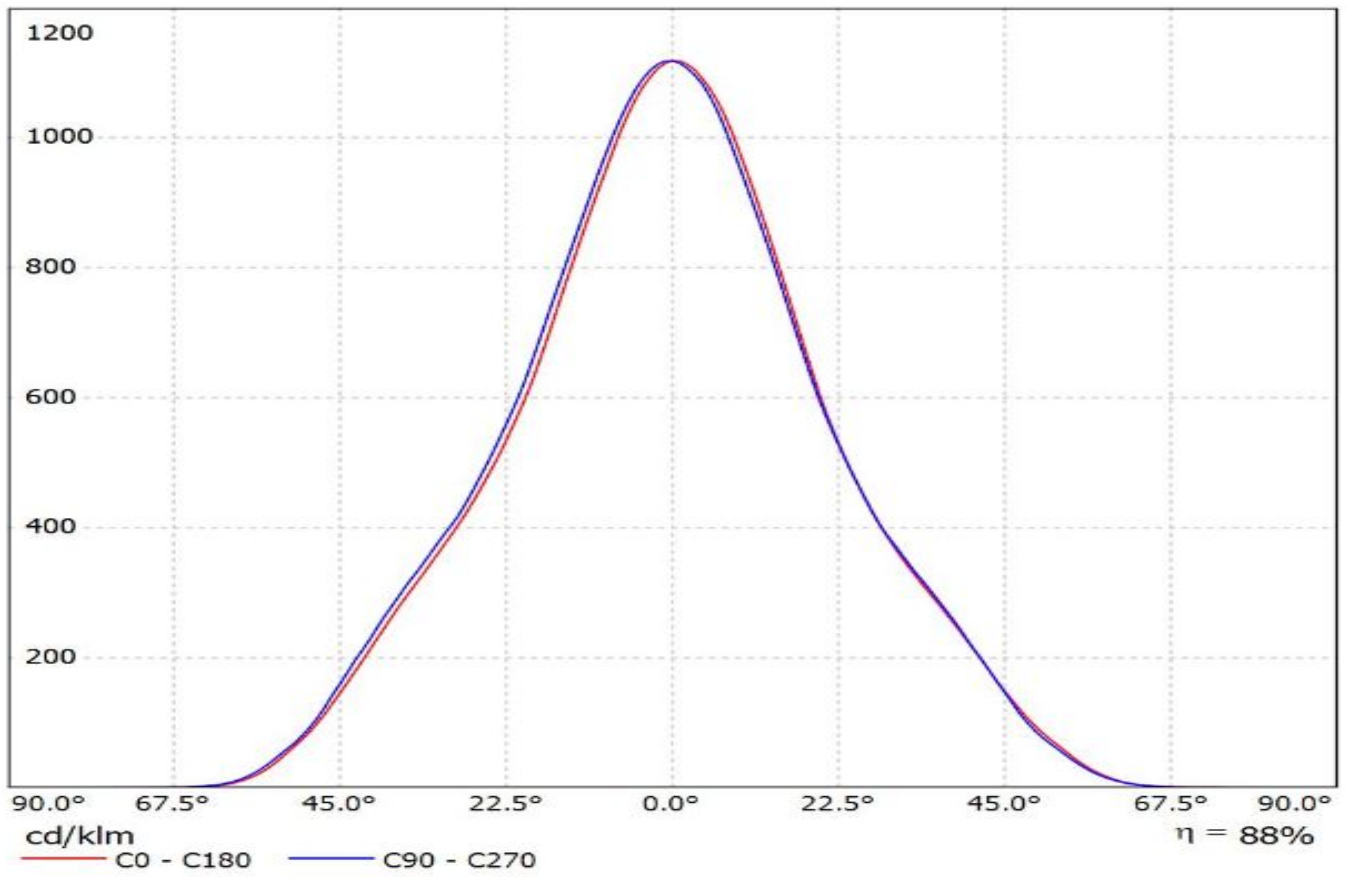

Luminaire: LEDil Oy C13557_BRIDGET-S-UNI_(Mini_Zenigata_GW5BJT) Efficiency=87%
Lamps: 1 x Sharp Mini Zenigata (GW5BTJ) 378lm @ 250mA CCT=4100K P=4.5W I=250mA

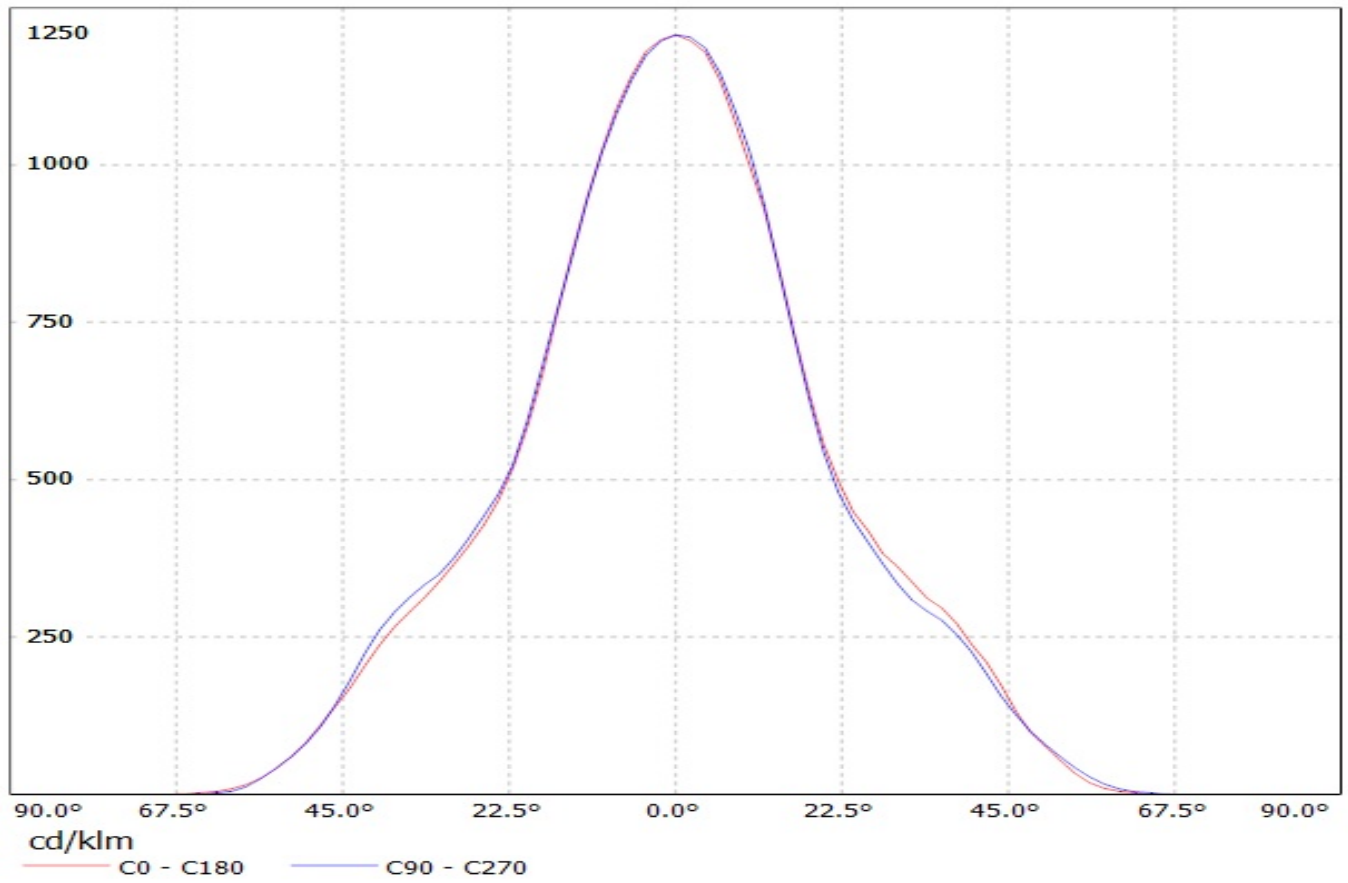

Luminaire: LEDiL Oy C13557_BRIDGET-S-UNI_(SLE-G5_LES-6)
Lamps: 1 x Tridonic_SLE-G5_LES-6_470.59lm@100mA_P=3.3748W_I=0.100A

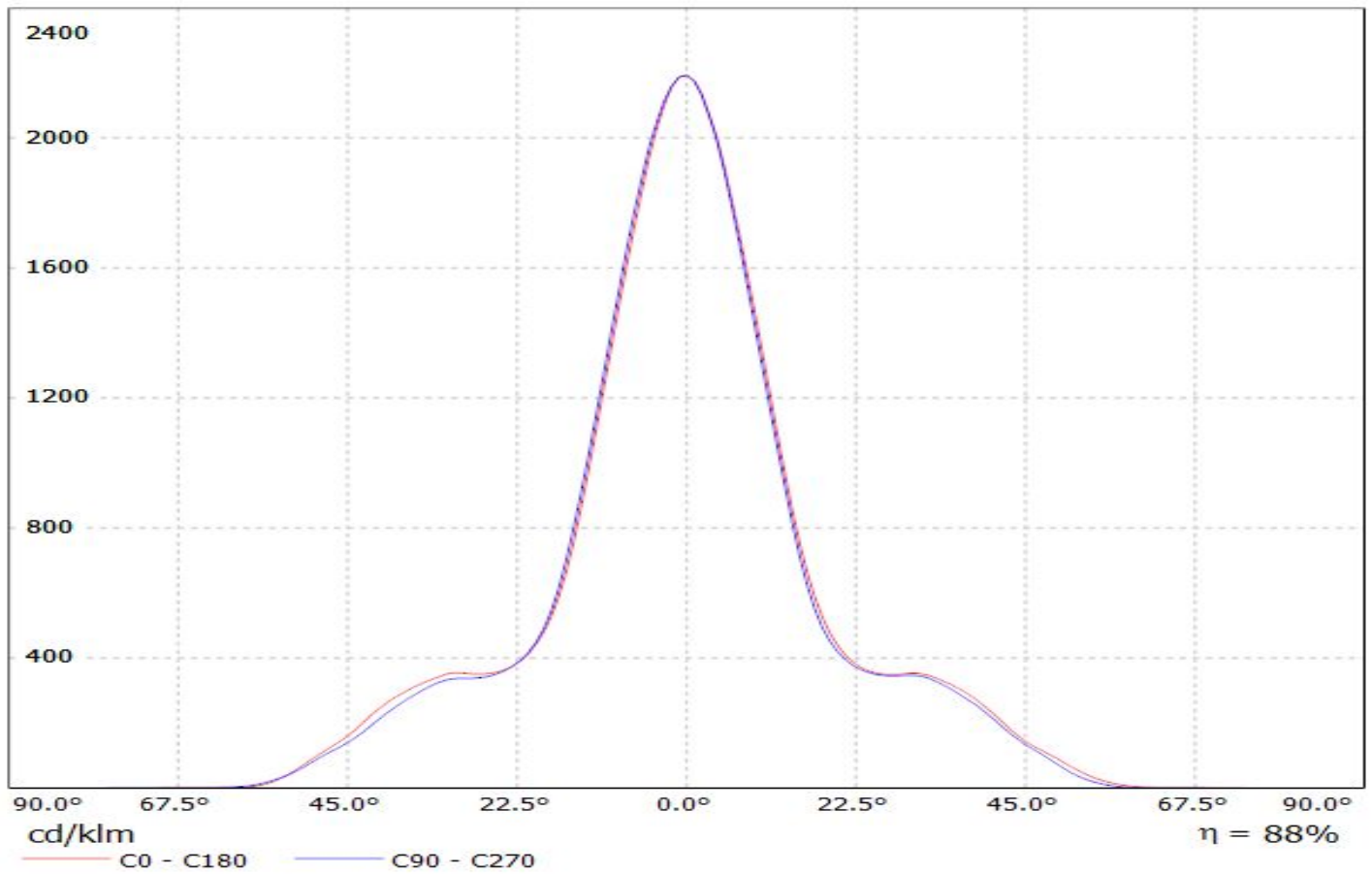

Luminaire: LEDiL Oy C13557_BRIDGET-S-UNI_(SLE-G5_LES-11)
Lamps: 1 x Tridonic_SLE-G5_LES-11_1166.25lm@250mA_P=8.3218W_I=0.250A

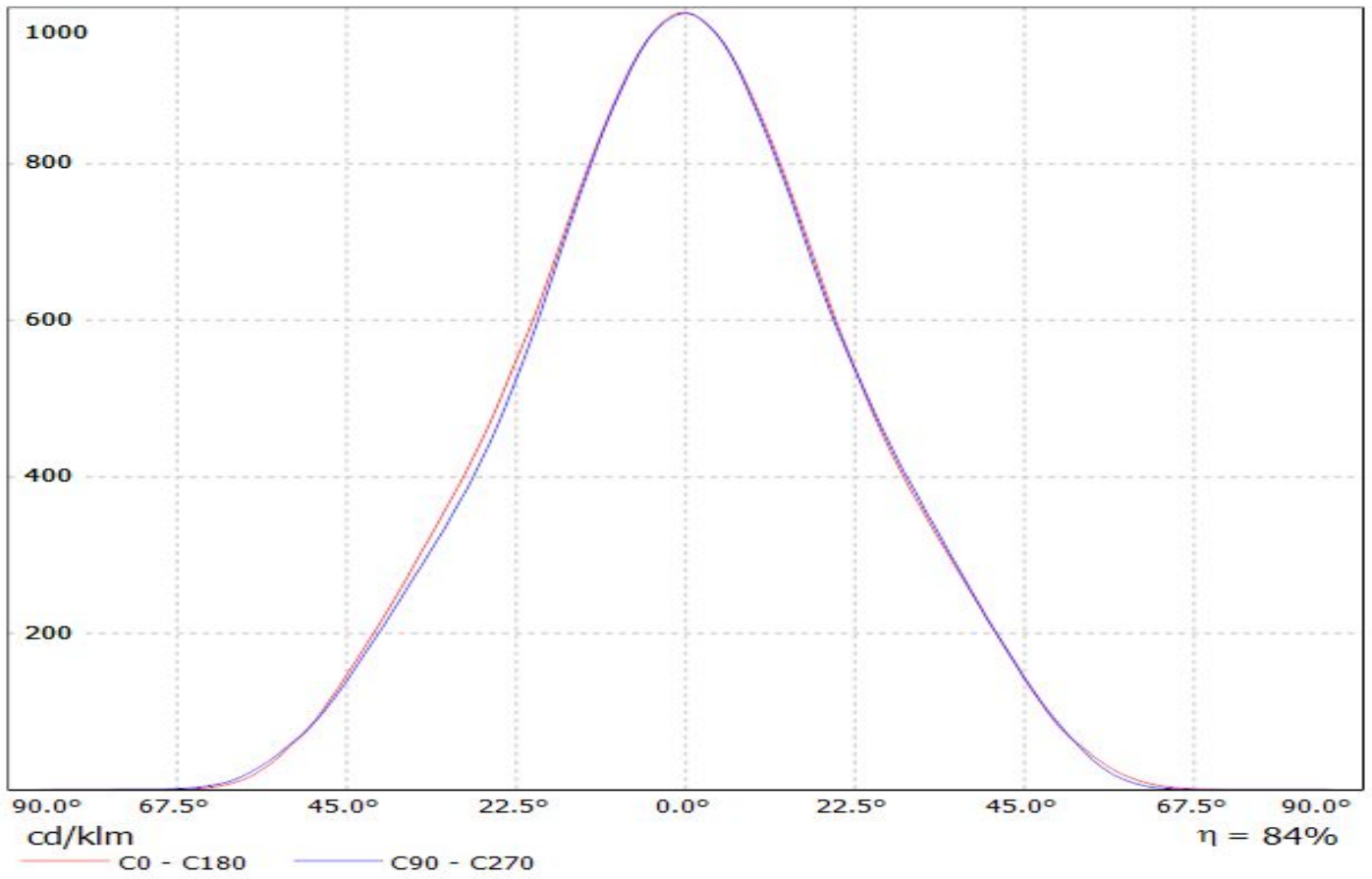

Luminaire: LEDil Oy C13557_BRIDGET-S-UNI_(BXRA_ES_STAR) Efficiency=86%
Lamps: 1 x Bridgelux BXRA ES Star (C0402) 203lm @ 250mA CCT=7300K P=2.2W I=250mA

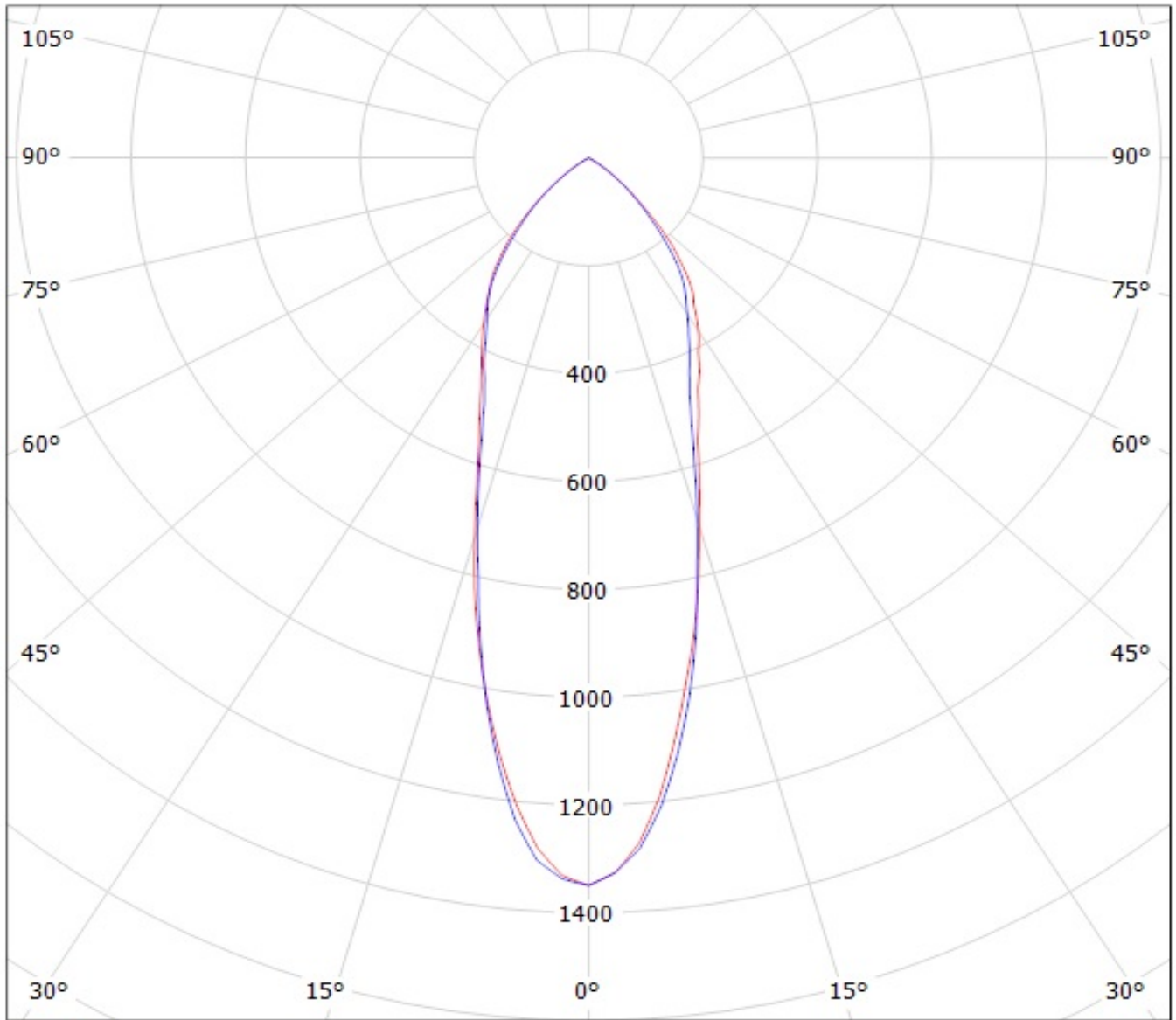

cd/klm

— C0 - C180

— C90 - C270

Luminaire: LEDil Oy C13557_BRIDGET-S-UNI_(CLL020) Efficiency=85%

Lamps: 1 x Citizen CLL020 (CLL020-1202A5-303H1A7) 515lm @ 250mA CCT=3000K P=9.3W I=250mA

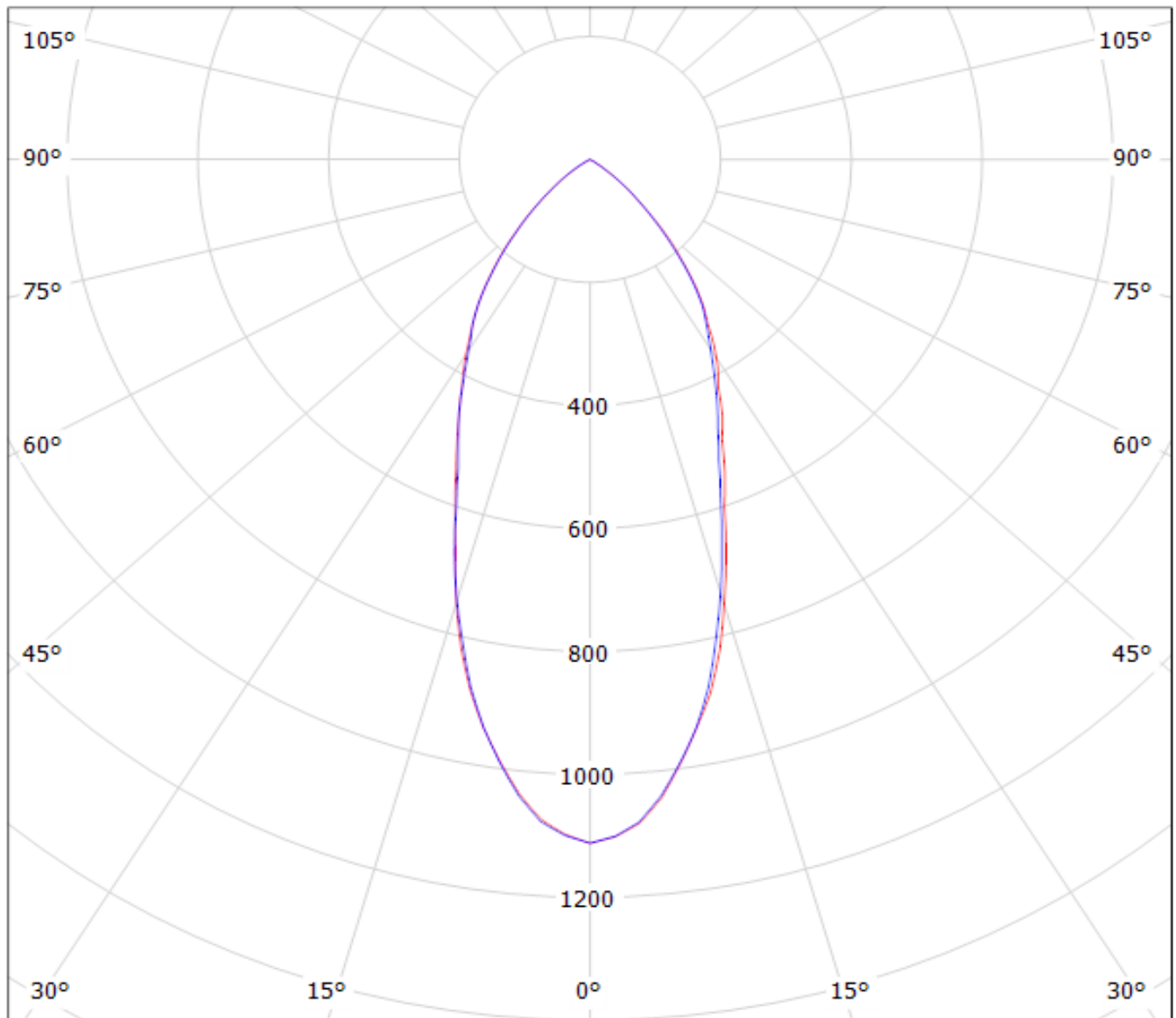

cd/klm

— C0 - C180

— C90 - C270

Luminaire: Ledil C13557_BRIDGET-S-UNI_(CLU700)

Lamps: 1 x Citizen_CLU700_394.637lm@100mA_P=2.8W_I=0.10A

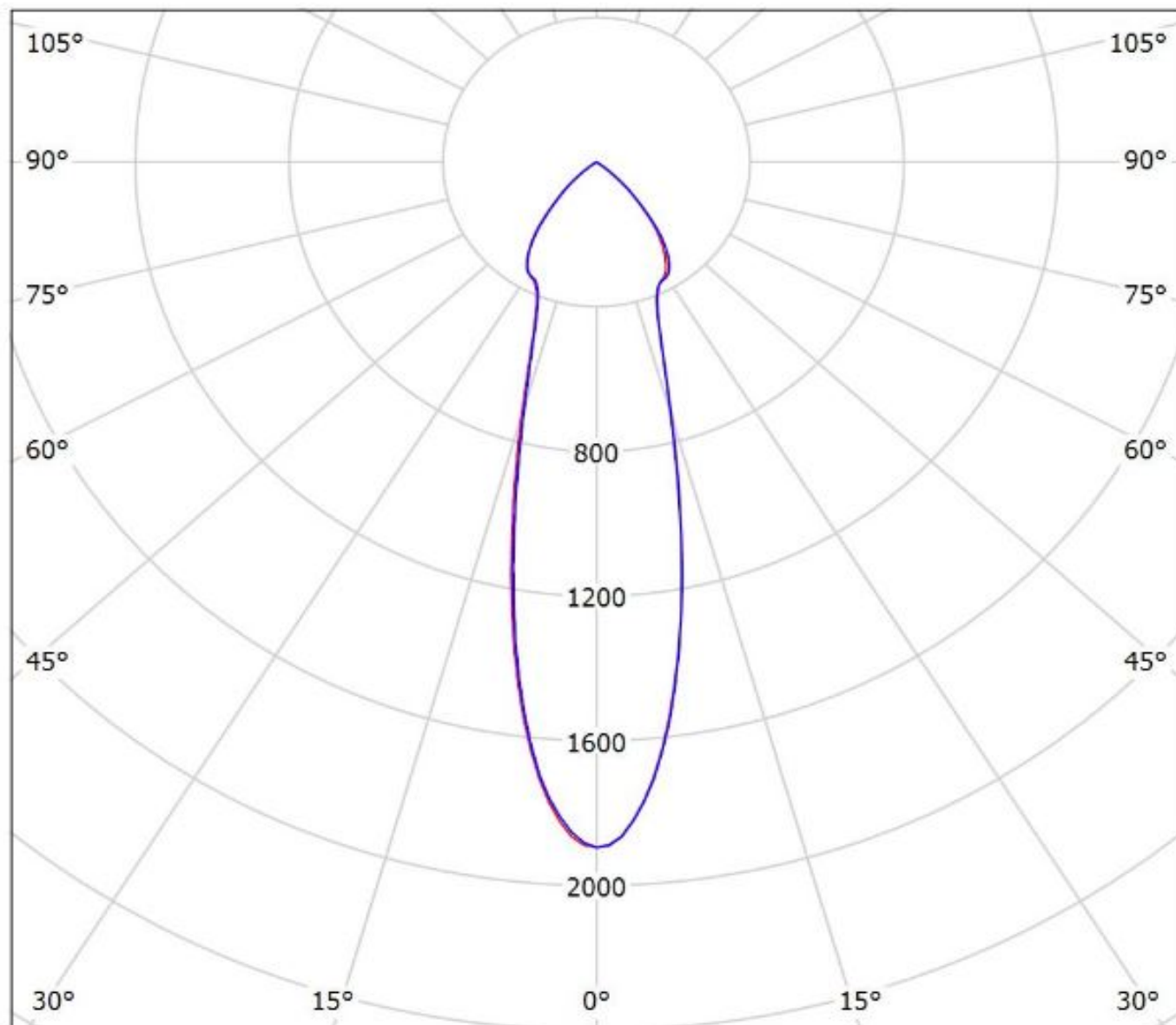

cd/klm

— C0 - C180 — C90 - C270

$\eta = 87\%$

Luminaire: LEDil Oy C13557_BRIDGET-S-UNI_(CXA15) Efficiency=87%
Lamps: 1 x Cree CXA15 (CXA1507-30F-F2-N0A-00000) 218lm @ 250mA CCT=3100K P=1.7W I=250mA

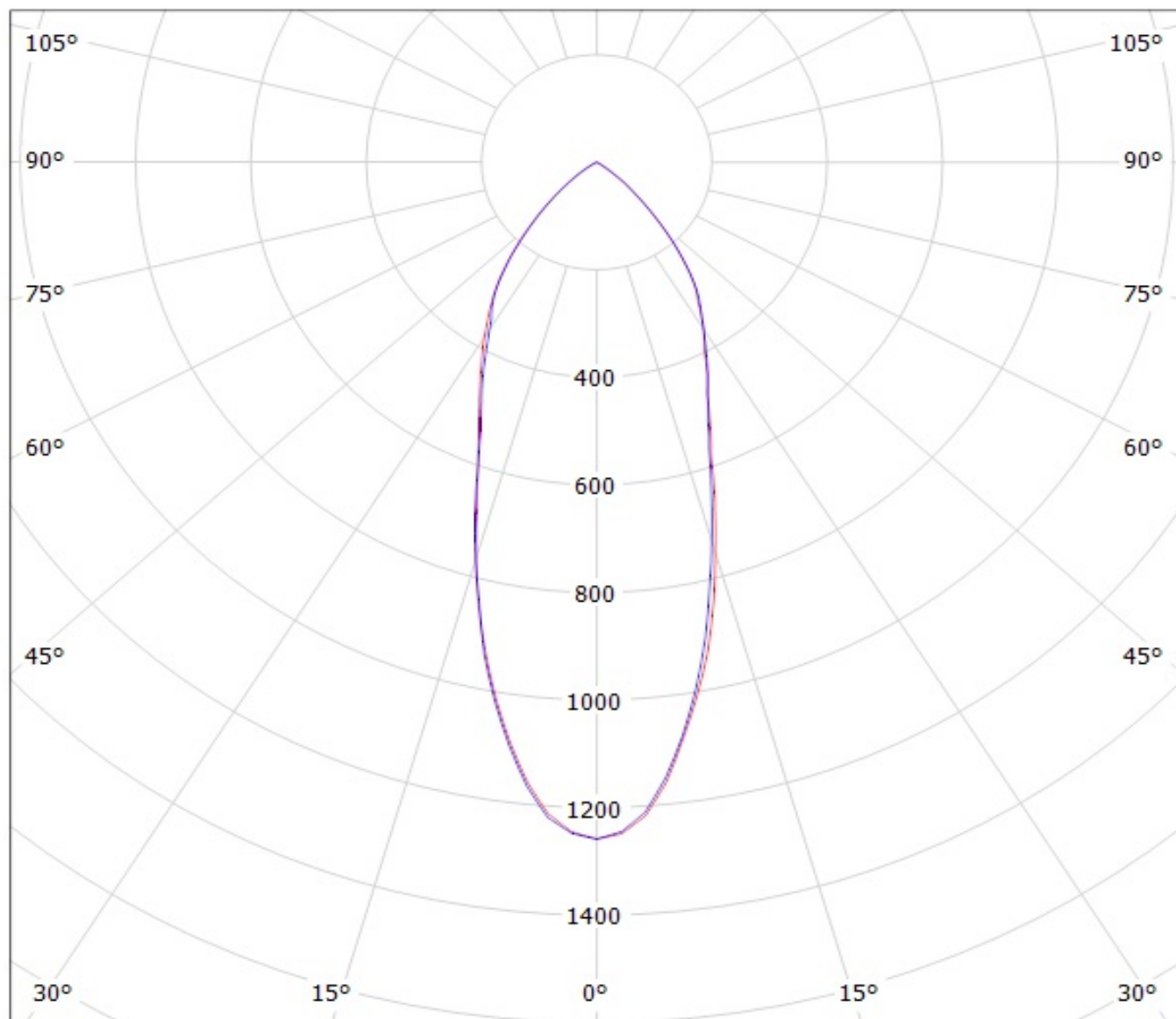

cd/klm

— C0 - C180

— C90 - C270

Luminaire: LEDiL Oy C13557_BRIDGET-S-UNI_(CXM-9)

Lamps: 1 x Luminus_XNOVA_CXM-9_(AA00)_977.302lm@240mA_P=8.28264W_I=240mA

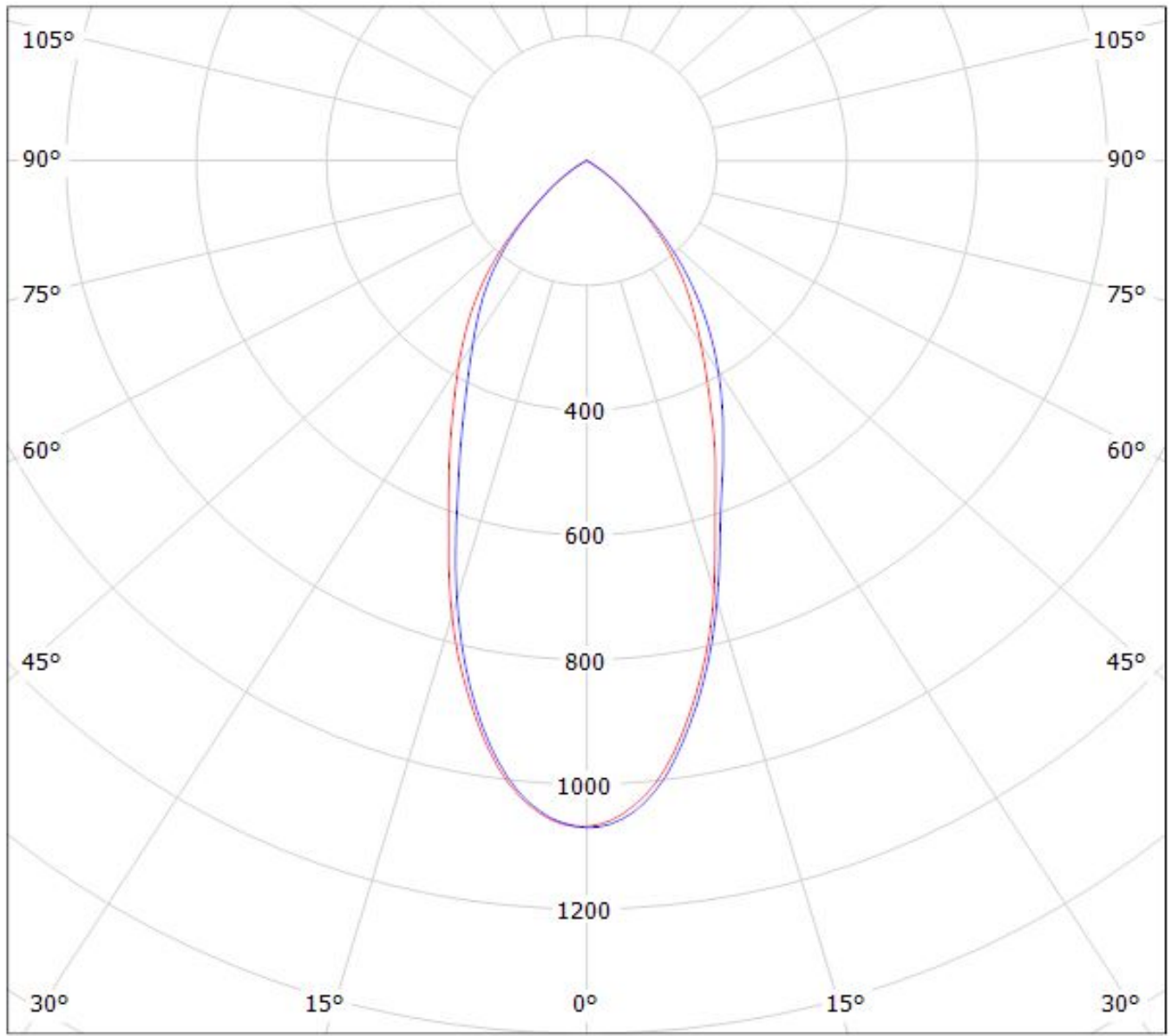

cd/klm

— C0 - C180

— C90 - C270

$\eta = 87\%$

Luminaire: Ledil Oy C13557_BRIDGET-S-UNI_(Soleriq_S9)_SIMULATED
Lamps: 1 x Osram Soleriq S9 (GW KAFJB3.EM)

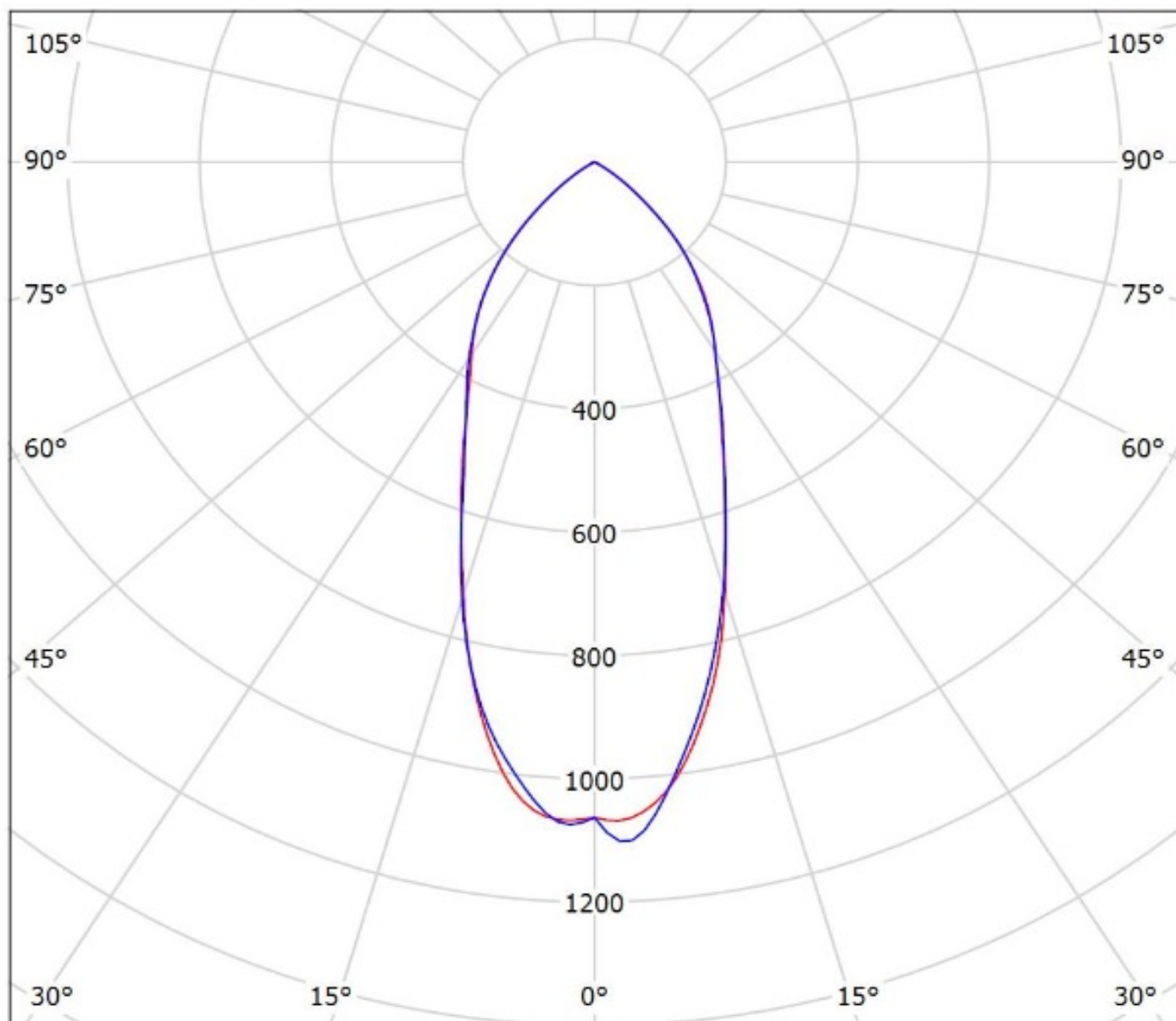

cd/klm

— C0 - C180 — C90 - C270

$\eta = 89\%$

Luminaire: LEDiL Oy C13557_BRIDGET-S-UNI_(COB_D_LES_9.8mm)

Lamps: 1 x Samsung_COB_D_series_LES_9.8mm_LC013D_534.999lm@100mA_P=3.1948W_I=0.100A

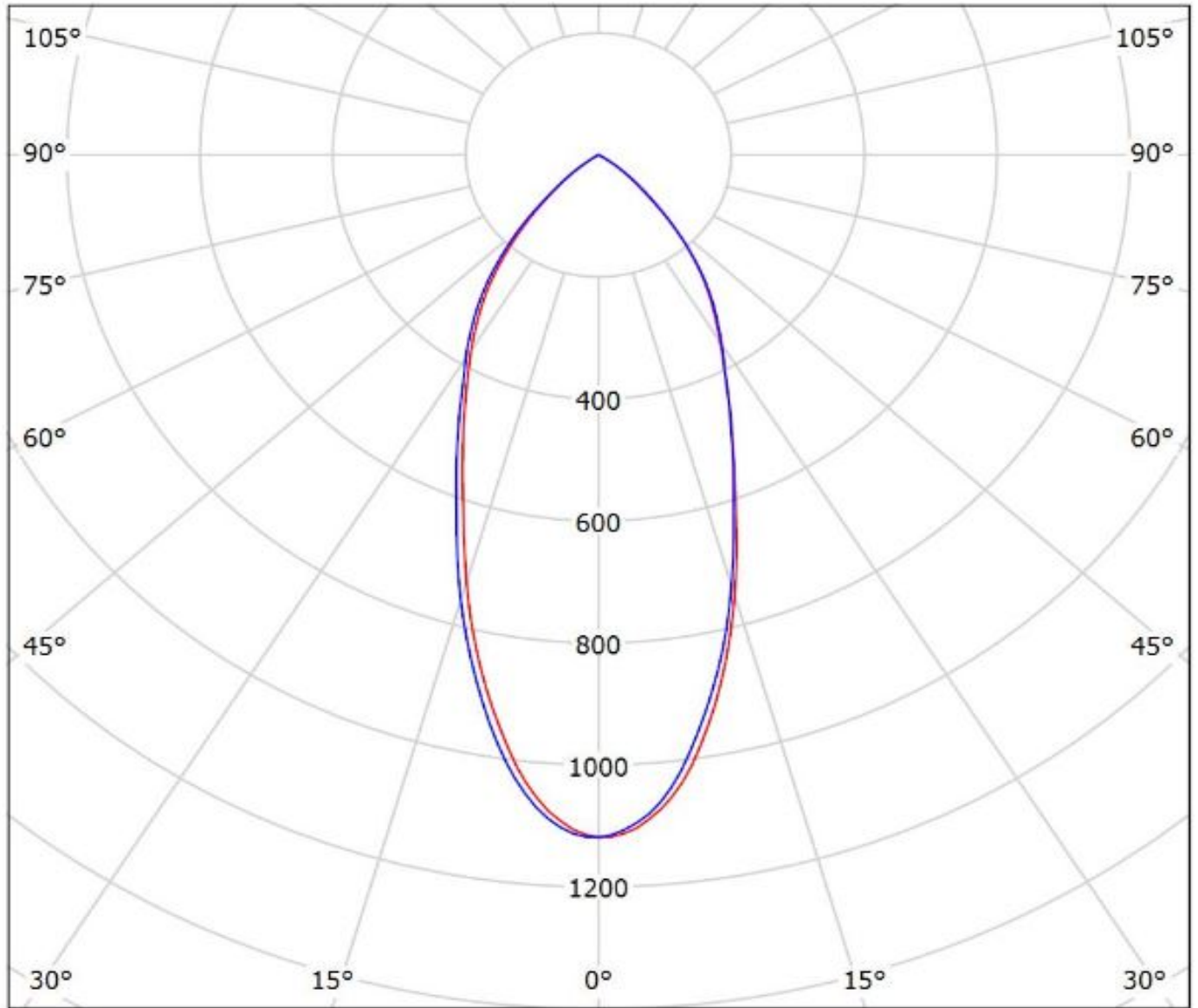

cd/klm

— C0 - C180

— C90 - C270

$\eta = 88\%$

Luminaire: LEDil Oy C13557_BRIDGET-S-UNI_(Mini_Zenigata_GW5BJT) Efficiency=87%
Lamps: 1 x Sharp Mini Zenigata (GW5BTJ) 378lm @ 250mA CCT=4100K P=4.5W I=250mA

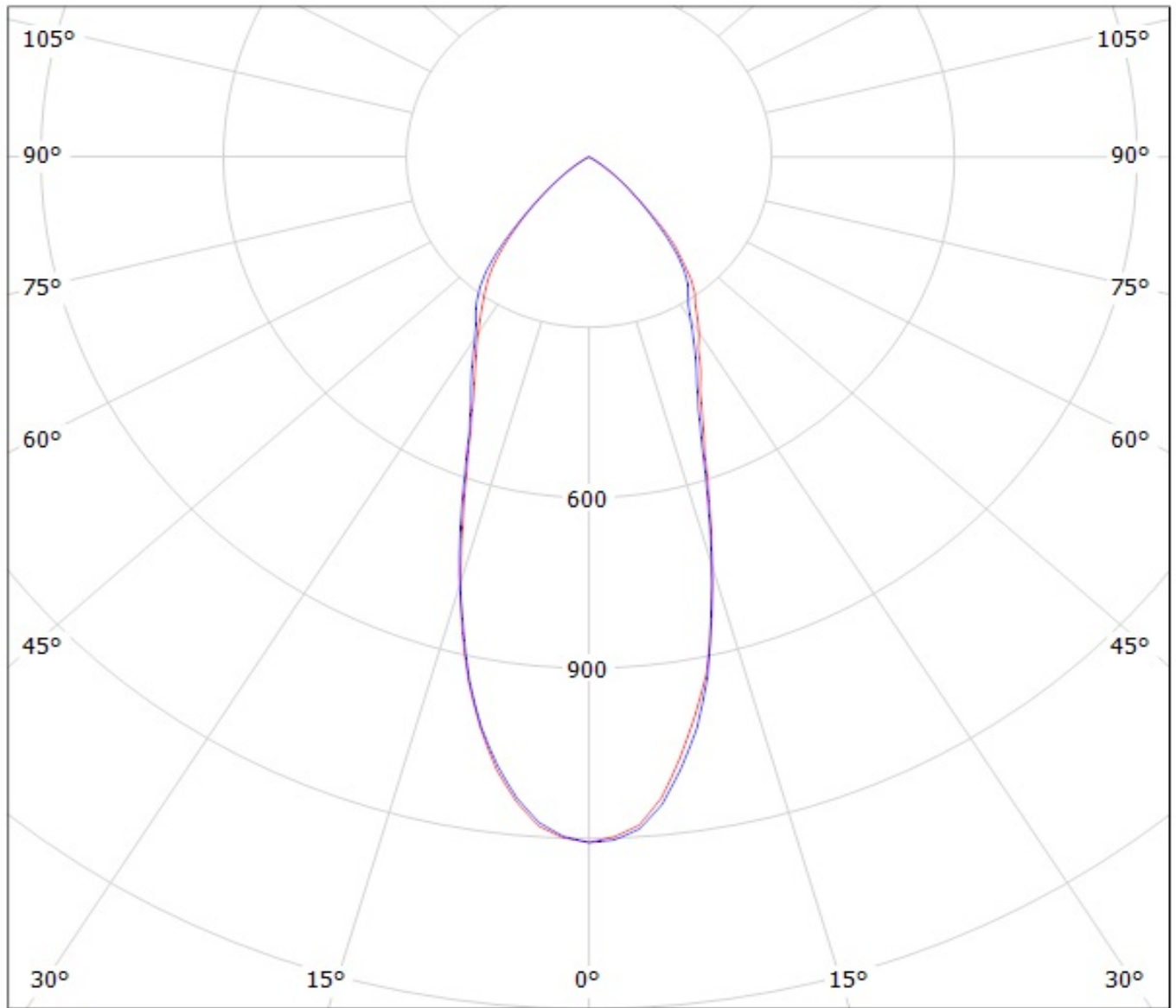

cd/klm

— C0 - C180

— C90 - C270

Luminaire: LEDiL Oy C13557_BRIDGET-S-UNI_(SLE-G5_LES-6)

Lamps: 1 x Tridonic_SLE-G5_LES-6_470.59lm@100mA_P=3.3748W_l=0.100A

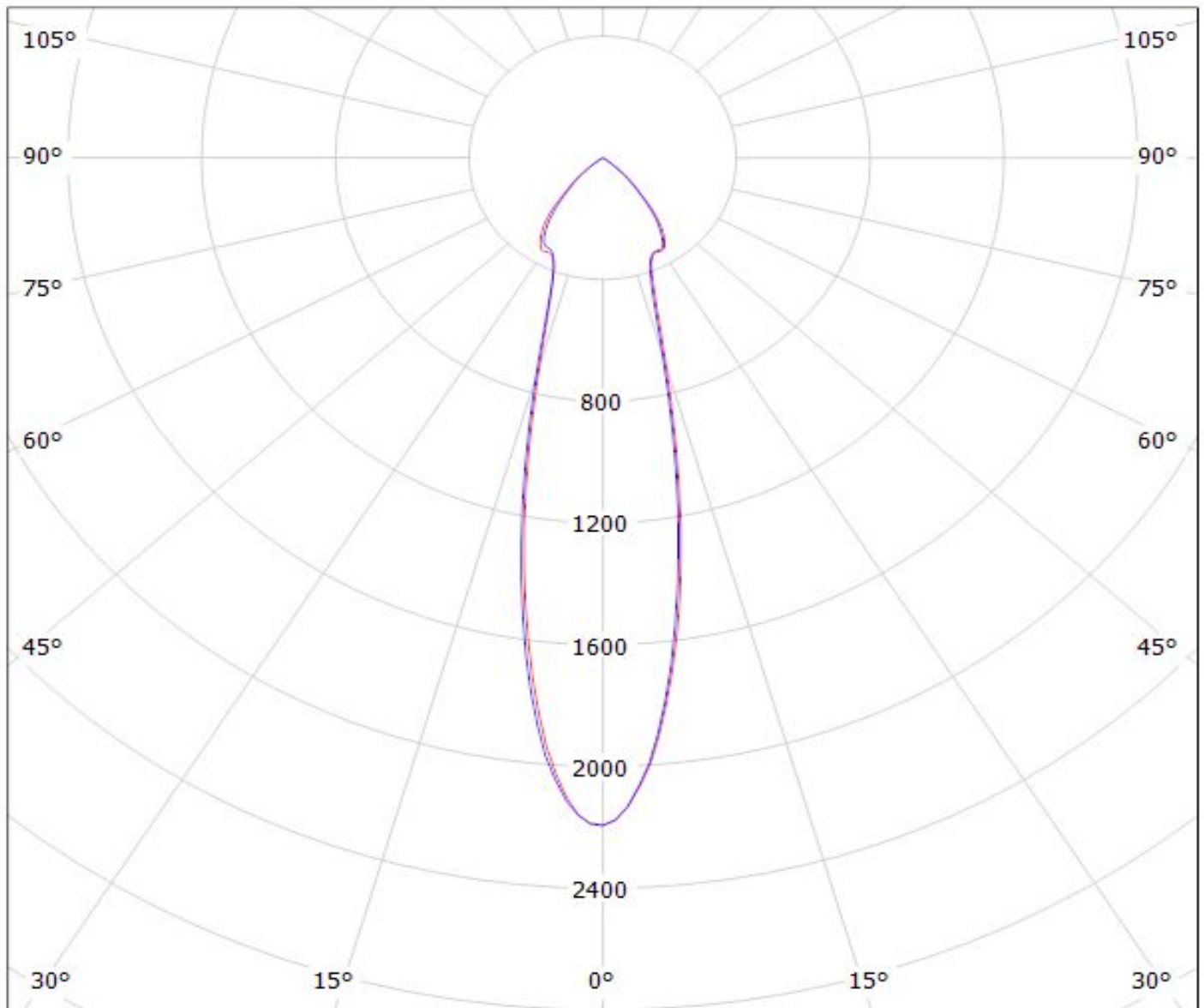

cd/klm

$\eta = 88\%$

— C0 - C180

— C90 - C270

Luminaire: LEDiL Oy C13557_BRIDGET-S-UNI_(SLE-G5_LES-11)

Lamps: 1 x Tridonic_SLE-G5_LES-11_1166.25lm@250mA_P=8.3218W_I=0.250A

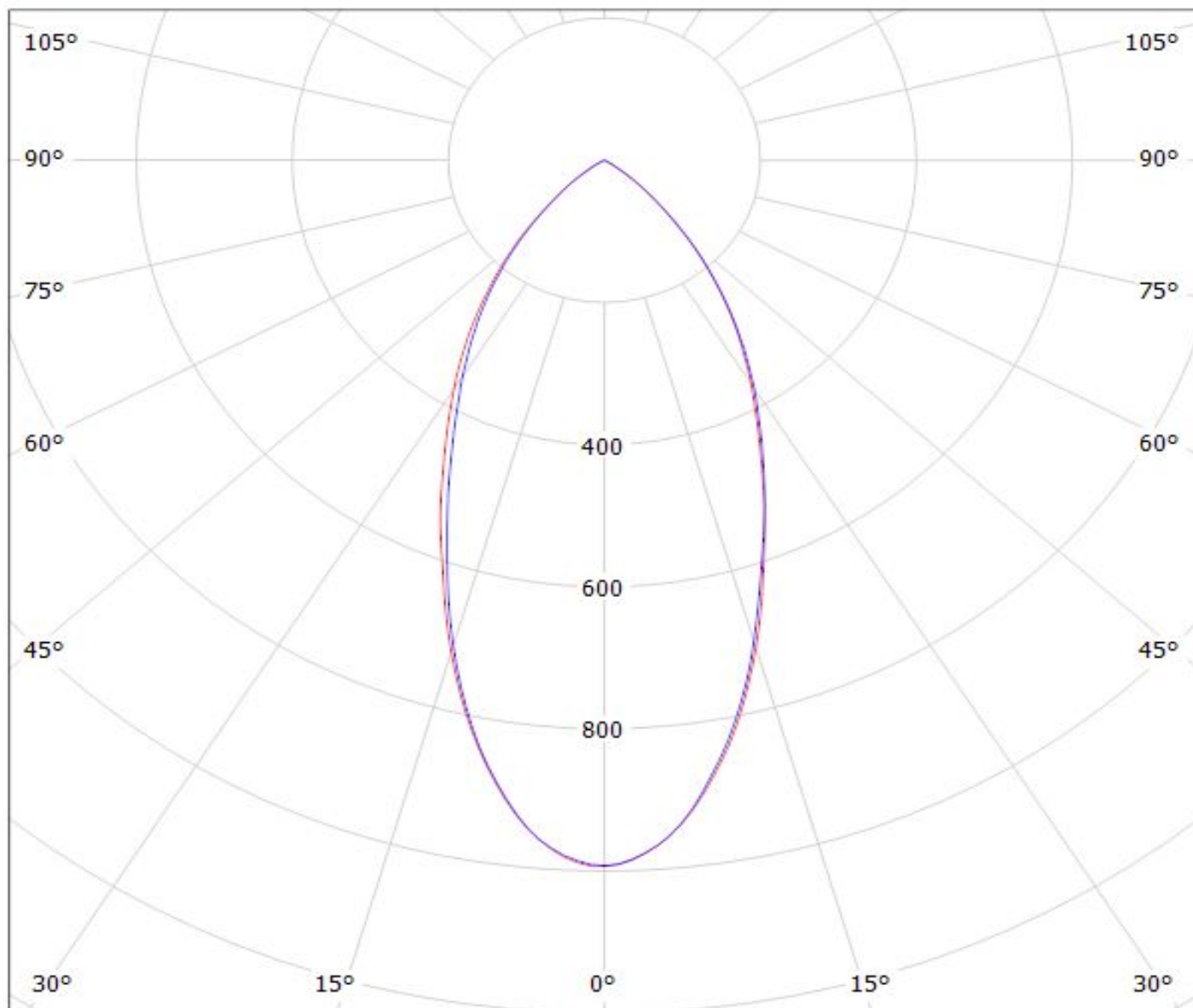

cd/klm

— C0 - C180

— C90 - C270

$\eta = 84\%$

NOTE: The typical divergence will be changed by different color, chip size and chip position tolerance. The typical total divergence is the full angle measured where the luminous intensity is half of the peak value.

GENERAL INFORMATION

- Product series especially designed & optimized for series of LEDs.
- Special care taken to make light distribution as uniform as possible.

Note! Due to use of high power COB's with this product, special attention to proper thermal design is highly recommended. LEDiL has no liability for direct, indirect or consecutive damages arising from the LEDiL products being used outside of the recommended temperature range.