

THIS IS A C.A.D. GENERATED DRAWING  
DO NOT MAKE MANUAL REVISIONS TO MASTER.

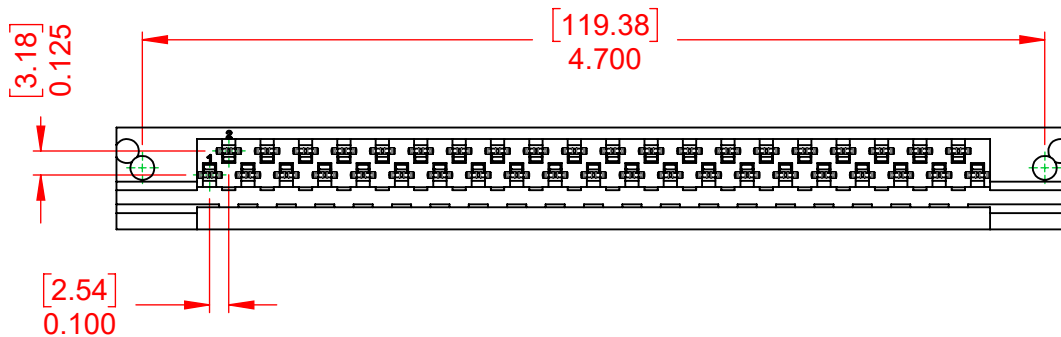

ISSUE NUMBER	
ORIGINAL	①

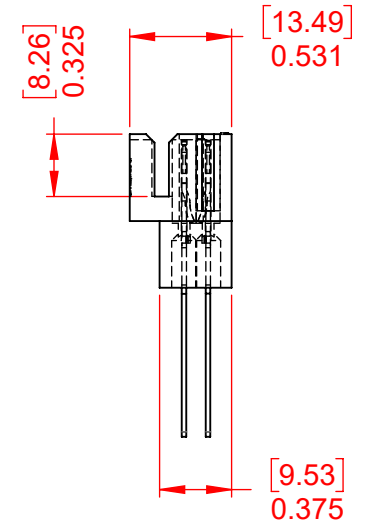
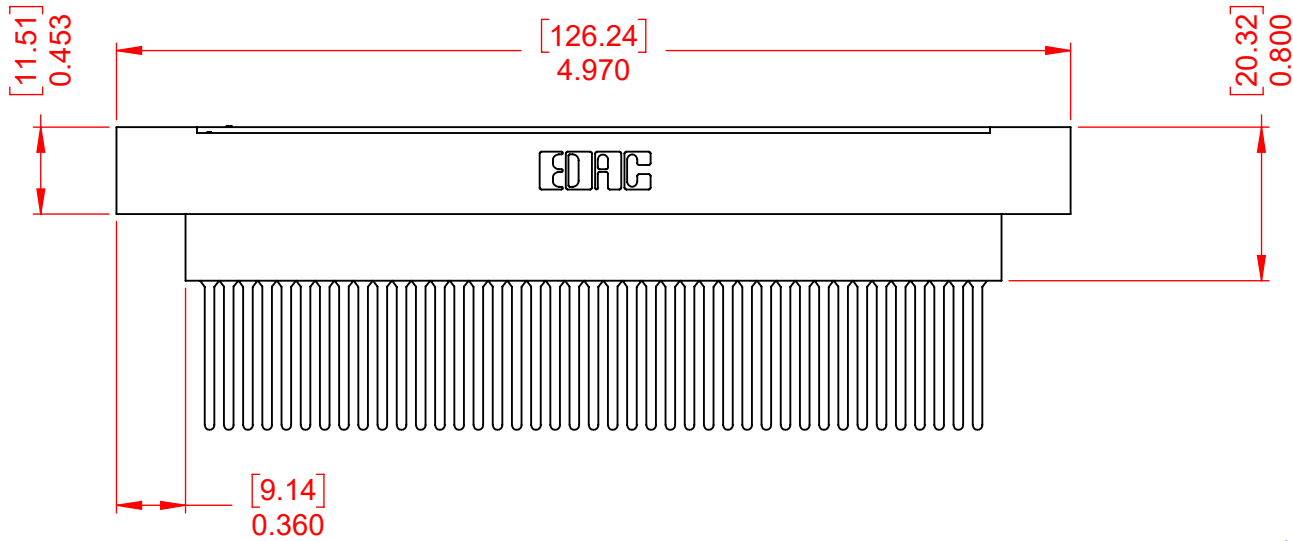

**NOTES:**

**MATERIAL:**

- HOUSING: DIALYL PTHYHALATE, UL94V-0
- CONTACT MATERIAL: COPPER ALLOY
- CONTACT PLATING: GOLD PLATING OVER NICKEL
- INSERTION FORCE: 6 TO 16 Oz (0.56 TO 4.45N) PER CONTACT
- WITHDRAWAL FORCE: 6 TO 16 Oz (0.56 TO 4.45N) PER CONTACT

OPERATING TEMPERATURE: -65°C ~ 125°C

- CURRENT RATING: 10A PER CONTACT
- CONTACT RESISTANCE: 10mΩ MAX.
- INSULATOR RESISTANCE: 5000MΩ min.
- DIELECTRIC WITHSTANDING VOLTAGE: 2000V AC rms AT SEA LEVEL

**CONTACT TYPE:**

542-Wire Wrap .050x.025(1.27x0.61) - Tail LG.=.790(20.07)



THIS SERIES FULLY CONFORMS TO  
THE EUROPEAN UNION DIRECTIVES  
2011/65/EU FOR RoHS COMPLIANCY.



YOUR CONNECTION TO QUALITY & SERVICE

EDAC INC  
TORONTO, ONTARIO  
CANADA

THESE DRAWINGS AND SPECIFICATIONS  
ARE THE PROPERTY OF EDAC INC., AND  
SHALL NOT BE REPRODUCED, OR COPIED  
OR USED AS THE BASIS FOR THE  
MANUFACTURE OR SALE OF APPARATUS  
WITHOUT WRITTEN PERMISSION.

**415 & 438 SERIES CARD EDGE**

SW REFERENCE NO.: 415 ASSEMBLY	
DRAWN: W.T	DATE: AUG. 01/2018
CHECKED:	DATE:
SCALE: 1:1	SHEET 1 OF 1
DRAWING NUMBER: 438-041-542-122	ISSUE
PART NUMBER: 438-041-542-122	1