

12384.4

PK 100/24/5,00-H DG

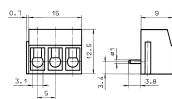

M3

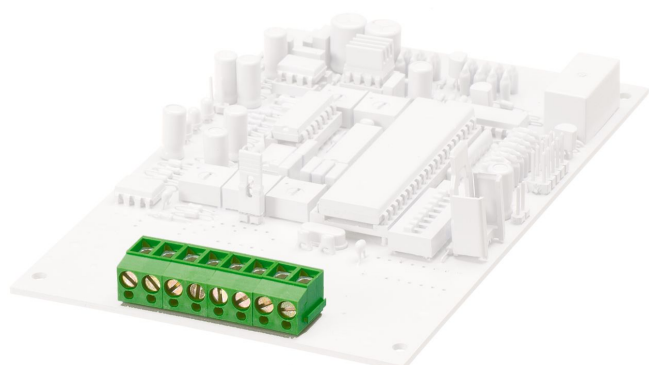
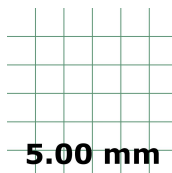

5.00 mm



PCB terminal, Wire protection, No. of poles: 24, Width: 120.7 mm, Colour: Dark grey

## Business data

|  |          |
|--|----------|
| Packaging unit                             | 50       |
| Quantity unit                              | PC       |
| Packaging type                             | Carton   |
| Type of banding                            | Without  |
| Weight per piece (not including packaging) | 26.8 g   |
| Weight per piece (including packaging)     | 28.6 g   |
| Unit of weight                             | G        |
| Customs number                             | 85369010 |
| Country of origin                          | QU       |
| Prio-Article                               | 12384.1  |

12384.4

PK 100/24/5,00-H DG

---

## Technical data

---

### Dimensions

---

|                            |          |
|----------------------------|----------|
| Length                     | 12.5 mm  |
| Length of the pin          | 3.8 mm   |
| Width                      | 120.7 mm |
| Width left                 | 3.2 mm   |
| Width right                | 2.5 mm   |
| Height                     | 9 mm     |
| Drill hole diameter        | 1.3 mm   |
| Diameter of connecting pin | 1 mm     |
| Pitch                      | 5 mm     |

### Ratings

---

|                       |                     |
|-----------------------|---------------------|
| Rated voltage         | 250 V               |
| Rated current         | 24 A                |
| Rated cross-section   | 2.5 mm <sup>2</sup> |
| Rated impulse voltage | 2 kV                |
| Overvoltage category  | III                 |
| Contamination degree  | 3                   |

### Technical data

#### Connection data

|  |                          |
|--|--------------------------|
| Connection principle                                     | Wire protection          |
| Connection type of PCB                                   | Solder connection        |
| Type of attachment to circuit board                      | Connecting contact       |
| Angle of PCB/wire connection                             | 90° (vertically upwards) |
| No. of poles   | 24                       |
| Number of levels   | 1                        |
| Wire cross-section single-core (rigid) / stranded, min.  | 0.2 mm <sup>2</sup>      |
| Wire cross-section single core (rigid)/stranded, max.    | 2.5 mm <sup>2</sup>      |
| Wire cross-section stranded, min.                        | 0.2 mm <sup>2</sup>      |
| Wire cross-section stranded, max.                        | 2.5 mm <sup>2</sup>      |
| Wire cross-section stranded with wire-end ferrules, min. | 0.2 mm <sup>2</sup>      |
| Wire cross-section stranded with wire-end ferrules, max. | 2.5 mm <sup>2</sup>      |
| Wire cross-section AWG, min.                             | 22                       |
| Wire cross-section AWG, max.                             | 12                       |
| Stripping length   | 6 mm                     |
| Screw threading  | M 3                      |
| Torque   | 0.5 Nm                   |

#### Materials

|                           |                 |
|---------------------------|-----------------|
| Insulation housing        | Polyamide 6.6   |
| Flammability class UL 94  | V-0             |
| Working temperature, min. | -30 °C          |
| Working temperature, max. | 105 °C          |
| Clamping element          | Brass           |
| Screws                    | Steel           |
| Wire protection           | Stainless steel |

12384.4

PK 100/24/5,00-H DG

## Technical data

### Further technical data

|  |                             |
|--|-----------------------------|
| Storage temperature, min.                      | -40 °C                      |
| Storage temperature, max.                      | 105 °C                      |
| Insulation resistance                          | 1*10 <sup>13</sup> Ohm x cm |
| Creepage-current resistance                    | CTI 600                     |
| Glow wire flammability index GWFI              | GWFI 850                    |
| GWFI after-glow time                           | 30 Sek.                     |
| Glow wire ignition temperature GWIT            | GWIT 775 °C                 |
| GWIT exposure time                             | 5 Sek.                      |
| Connection cycles, in compliance with standard | 5                           |
| Recommended wave soldering temperature         | 265 °C                      |
| Recommended wave soldering duration, min.      | 3 Sek.                      |
| Recommended wave soldering duration, max.      | 4 Sek.                      |

### Print

|        |           |
|--------|-----------|
| Colour | Dark grey |
|--------|-----------|

### Environmental Product Compliance

|                                |            |
|--------------------------------|------------|
| REACH Conform                  | No         |
| REACH Reference date           | 2022-01-17 |
| REACH Candidate Substance Note | No         |
| REACH CAS 1 Substance          | LEAD       |
| REACH CAS 1 Percent minimal    | 0.1 %      |
| REACH CAS 1 Percent maximum    | 4 %        |
| REACH CAS 1 Number             | 7439-92-1  |
| RoHS Conform                   | yes        |
| RoHS Exception rule            | 6c         |

12384.4

PK 100/24/5,00-H DG

## Approvals

### cUL Recognized

|  |                 |
|--|-----------------|
| cUL approval   | CSA 22.2 No.158 |
| cUL Usegroup B: rated voltage                        | 300 V           |
| cUL Usegroup B: rated current                        | 20 A            |
| cUL Usegroup D: rated voltage                        | 300 V           |
| cUL Usegroup D: rated current                        | 10 A            |
| cUL wire cross-section single-core (rigid) AWG, min. | 22              |
| cUL wire cross-section single-core (rigid) AWG, max. | 12              |
| cUL wire cross-section stranded AWG, min.            | 12              |
| cUL wire cross-section stranded AWG, max.            | 22              |
| cUL torque   | 0.4499999881 Nm |
| cUL wire material                                    | Cu              |
| cUL Recognized                                       | yes             |

### UL Recognized

|   |         |
|---|---------|
| UL approval   | UL 1059 |
| UL Usegroup B: rated voltage                        | 300 V   |
| UL Usegroup B: rated current                        | 20 A    |
| UL Usegroup D: rated voltage                        | 300 V   |
| UL Usegroup D: rated current                        | 10 A    |
| UL wire cross-section single-core (rigid) AWG, min. | 22      |
| UL wire cross-section single-core (rigid) AWG, max. | 12      |
| UL wire cross-section stranded AWG, min.            | 12      |
| UL wire cross-section stranded AWG, max.            | 22      |
| UL torque   | 4 Lb In |
| UL wire material                                    | Cu      |
| UL factory wiring                                   | yes     |
| UL field wiring                                     | yes     |
| UL Recognized                                       | yes     |

12384.4

PK 100/24/5,00-H DG

---

## Approvals

---

### VDE approval

---

|   |                     |
|---|---------------------|
| VDE approval  | DIN EN 60998        |
| VDE approval granted                                | yes                 |
| VDE rated voltage                                   | 250 V               |
| VDE rated current                                   | 24 A                |
| VDE rated current wire cross-section rigid, max.    | 24 A                |
| VDE rated current wire cross-section stranded, max. | 24 A                |
| VDE rated impulse voltage                           | 2 kV                |
| VDE wire cross-section rigid, min.                  | 0.5 mm <sup>2</sup> |
| VDE wire cross-section rigid, max.                  | 2.5 mm <sup>2</sup> |
| VDE wire cross-section stranded, min.               | 0.5 mm <sup>2</sup> |
| VDE wire cross-section stranded, max.               | 2.5 mm <sup>2</sup> |
| VDE screw threading                                 | M 3                 |
| VDE torque  | 0.5 Nm              |
| VDE overvoltage category                            | III                 |
| VDE contamination degree                            | 3                   |

---

12384.4

PK 100/24/5,00-H DG

## Media

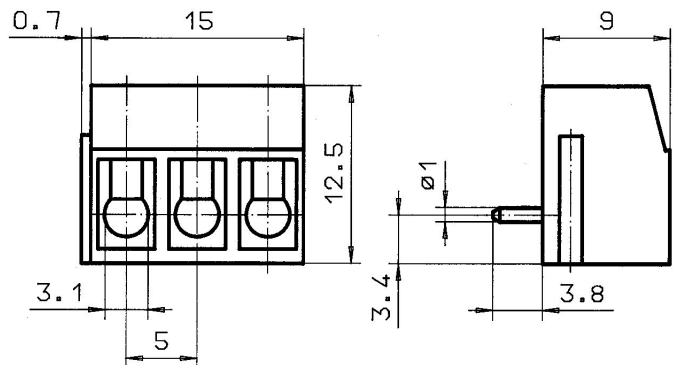

**M3**

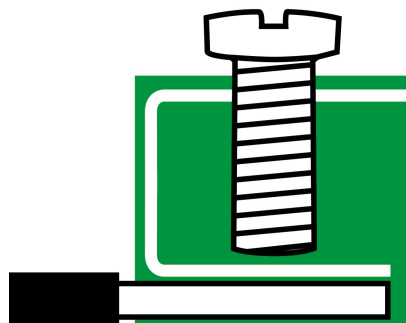
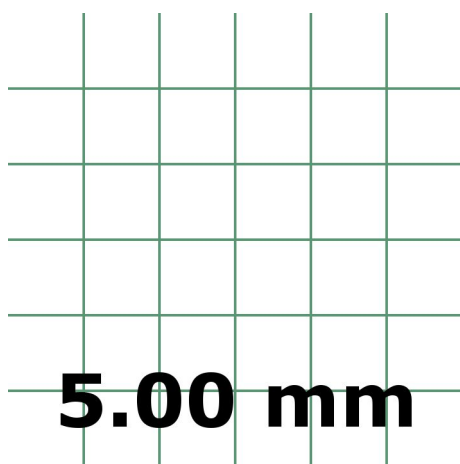
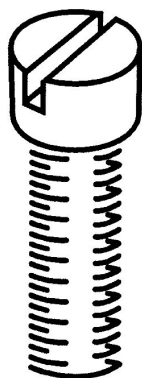

# Data sheet



12384.4

PK 100/24/5,00-H DG

---

## Accessories

---