

600 V, 5 A ultrafast recovery diode high efficiency

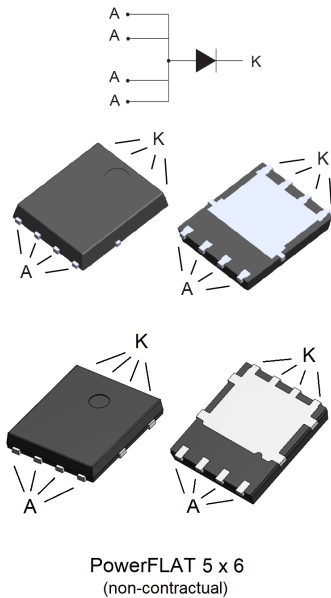

Features

- Suited for DC/DC converts
- Low losses
- High T_j
- High surge current capability
- High energy avalanche capability
- High integration
- Thin package: 1 mm
- ECOPACK2 compliant

Applications

- Switching diode
- SMPS
- DC/DC converter
- Telecom power

Description

High performance diode suited for high frequency DC to DC converters. Packaged in PowerFLAT 5x6, the **STTH5R06DJF** is optimized for use in low voltage high frequency inverters, free-wheeling and polarity protection applications. Its low profile was especially designed to be used in applications with space-saving constraints.

Product status

STTH5R06DJF

Product summary

$I_{F(AV)}$	5 A
V_{RRM}	600 V
$T_j(\text{max.})$	175 °C
$V_F(\text{typ.})$	0.95 V
$t_{rr}(\text{typ.})$	30 ns

1 Characteristics

Table 1. Absolute ratings (limiting values at 25 °C, unless otherwise specified, anode terminals short circuited)

Symbol	Parameter	Value	Unit
V _{RRM}	Repetitive peak reverse voltage	600	V
I _{F(RMS)}	Forward rms current	45	A
I _{F(AV)}	Average forward current	T _C = 160 °C, δ = 0.5, square wave	5
I _{FSM}	Surge non repetitive forward current	t _p = 10 ms sinusoidal	190
T _{stg}	Storage temperature range	-65 to +175	°C
T _j	Maximum operating junction temperature	175	°C

Table 2. Thermal parameters

Symbol	Parameter	Max. value	Unit
R _{th(j-c)}	Junction to case	2.0	°C/W

For more information, please refer to the following application note:

- [AN5046](#): Printed circuit board assembly recommendations for STMicroelectronics PowerFLAT packages

Table 3. Static electrical characteristics (anode terminals short circuited)

Symbol	Parameter	Test conditions	Min.	Typ.	Max.	Unit
I _R ⁽¹⁾	Reverse leakage current	T _j = 25 °C	-	60	600	μA
		T _j = 125 °C				
V _F ⁽²⁾	Forward voltage drop	T _j = 25 °C	-	1.55	2.00	V
		T _j = 125 °C				

1. Pulse test: t_p = 5 ms, δ < 2%

2. Pulse test: t_p = 380 μs, δ < 2%

To evaluate the conduction losses use the following equation:

$$P = 0.9 \times I_{F(AV)} + 0.06 I_F^2 \text{ (RMS)}$$

Table 4. Recovery characteristics

Symbol	Parameter	Test conditions	Min.	Typ.	Max.	Unit
t _{rr}	Reverse recovery time	T _j = 25 °C	-	30	40	ns
		I _F = 1 A, V _R = 30 V, dI _F /dt = - 100 A/μs				
I _{RM}	Reverse recovery current	T _j = 25 °C	-	6.0	8.0	A
		I _F = 1 A, V _R = 30 V, dI _F /dt = - 50 A/μs				
S _{factor}	Reverse recovery softness factor	T _j = 125 °C	-	0.5		-
Q _{rr}	Reverse recovery charges	I _F = 5 A, V _R = 400 V, dI _F /dt = - 200 A/μs	-	180		nC

For more information, please refer to the following application notes related to the power losses:

- [AN604](#): Calculation of conduction losses in a power rectifier
- [AN4021](#): Calculation of reverse losses in a power diode

Table 5. Turn-on switching characteristics

Symbol	Parameter	Test conditions		Min.	Typ.	Max.	Unit
t_{fr}	Forward recovery time	$T_j = 25\text{ °C}$	$I_F = 5\text{ A}$, $V_{FR} = 1.6\text{ V}$, $dI_F/dt = -100\text{ A}/\mu\text{s}$	-		150	ns
V_{FP}	Forward recovery voltage			-	2.3	3.5	V

1.1 Characteristics (curves)

Figure 1. Average forward power dissipation versus average forward current

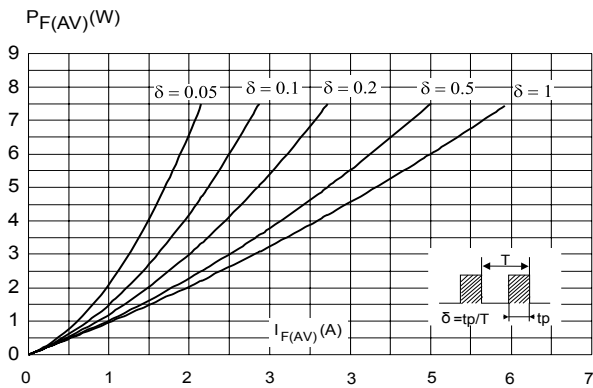

Figure 2. Forward voltage drop versus forward current

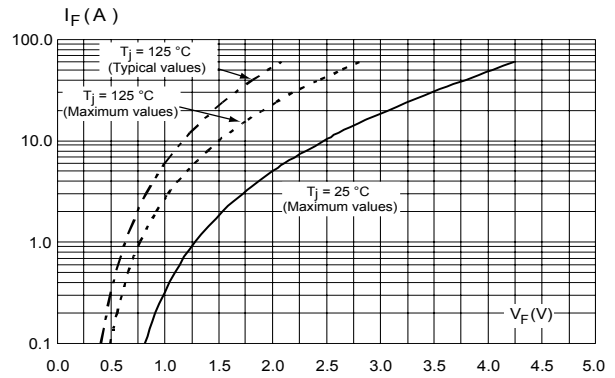

Figure 3. Relative variation of thermal impedance junction to case versus pulse duration

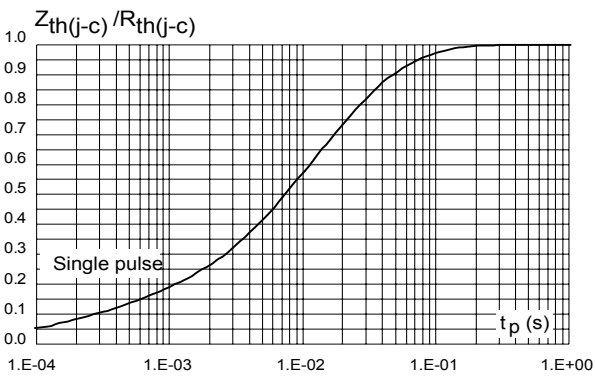

Figure 4. Peak reverse recovery current versus di_F/dt (typical values)

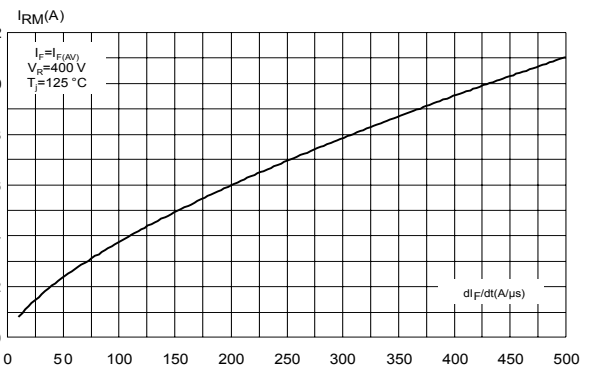

Figure 5. Reverse recovery time versus di_F/dt (typical values)

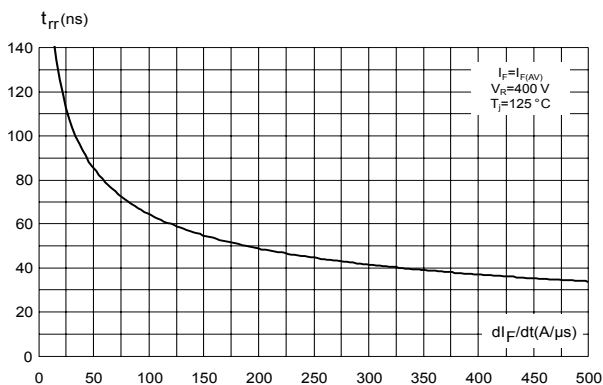

Figure 6. Reverse recovery charges versus di_F/dt (typical values)

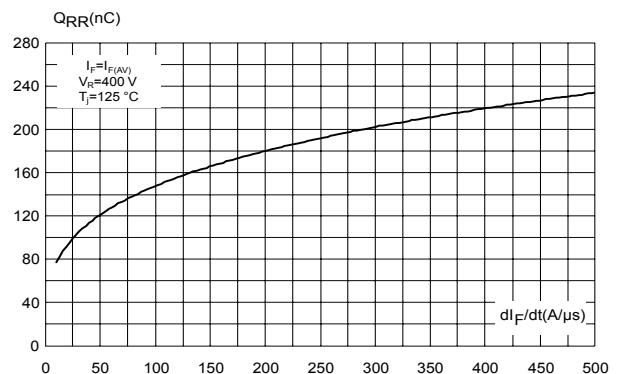

Figure 7. Softness factor versus di_F/dt (typical values)

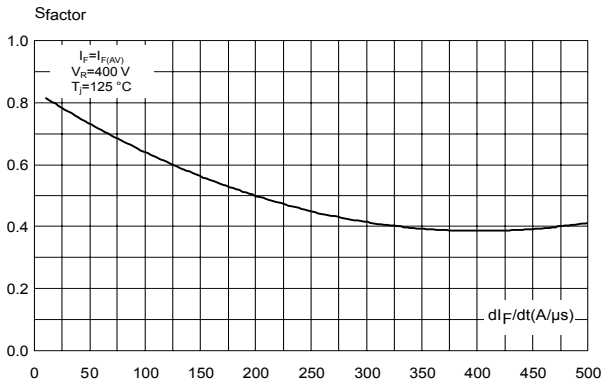

Figure 8. Relative variations of dynamic parameters versus junction temperature

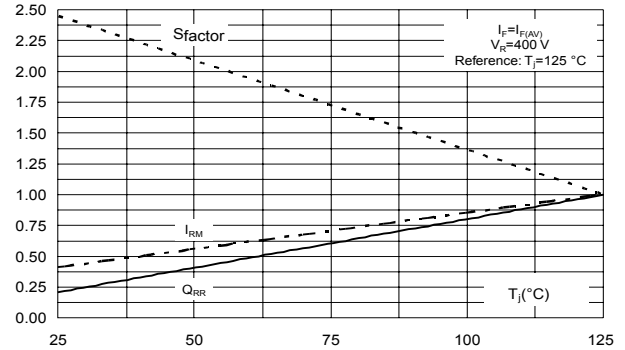

Figure 9. Transient peak forward voltage versus di_F/dt (typical values)

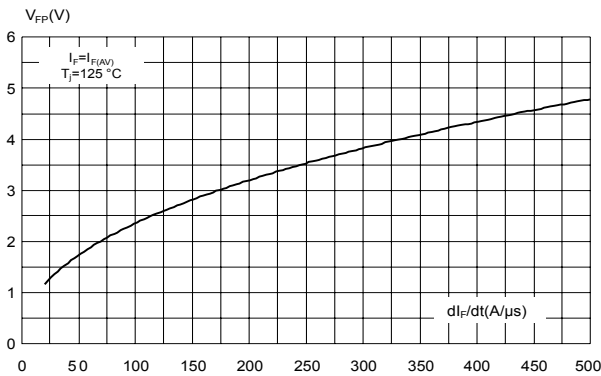

Figure 10. Forward recovery time versus di_F/dt (typical values)

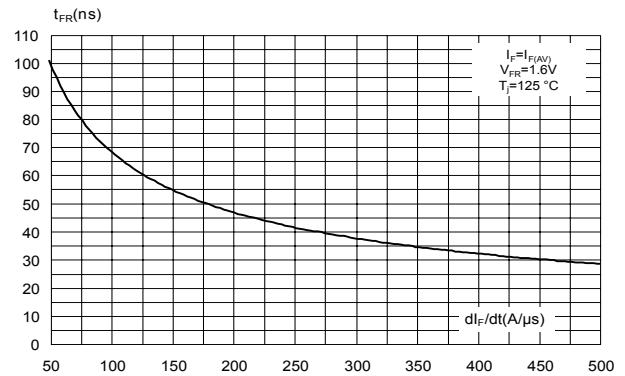

Figure 11. Junction capacitance versus reverse voltage applied (typical values)

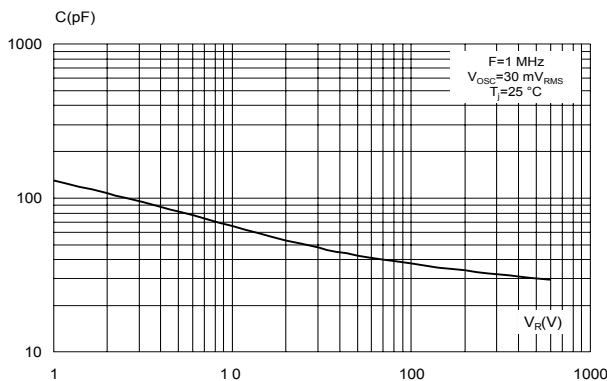
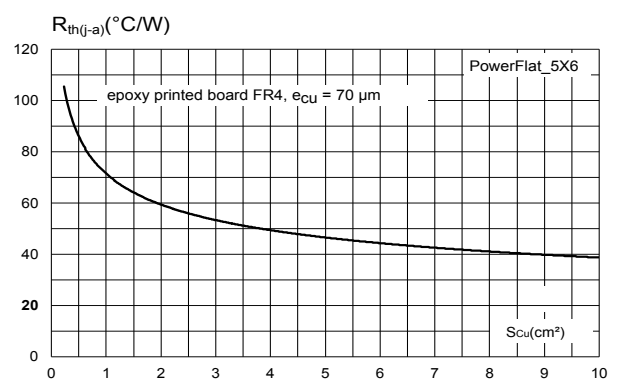

Figure 12. Thermal resistance junction to ambient versus copper surface under tab



2 Package information

In order to meet environmental requirements, ST offers these devices in different grades of **ECOPACK** packages, depending on their level of environmental compliance. ECOPACK specifications, grade definitions and product status are available at: www.st.com. ECOPACK is an ST trademark.

2.1 PowerFLAT 5x6 package information

- Epoxy meets UL 94, V0
- Cooling method: by conduction (C)

Figure 13. PowerFLAT 5x6 package outline (non-contractual)

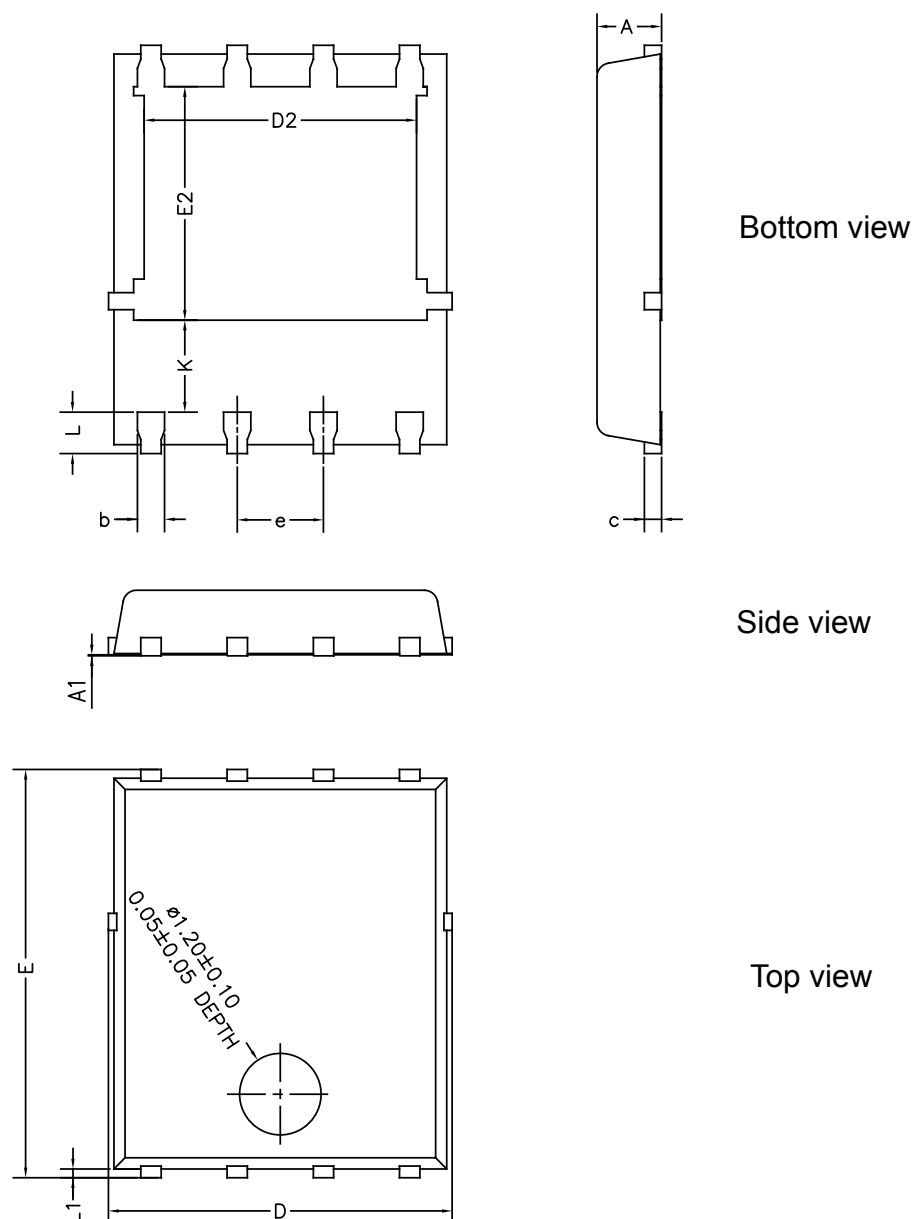

Note: This package drawing may slightly differ from the physical package. However, all the specified dimensions are guaranteed.

Table 6. PowerFLAT 5x6 mechanical data

Ref	Dimensions					
	Millimeters			Inches (for reference only)		
	Min.	Typ.	Max.	Min.	Typ.	Max.
A	0.80		1.00	0.031		0.039
A1	0.00		0.05	0.000		0.002
b	0.30		0.50	0.01		0.02
c		0.25			0.010	
D	4.80		5.40	0.189		0.212
D2	3.91		4.45	0.154		0.175
e		1.27			0.050	
E	5.90		6.35	0.232		0.250
E2	3.34		3.70	0.138		0.146
L	0.50		0.80	0.020		0.031
K	1.10		1.575	0.015		0.023
L1	0.05	0.15	0.25	0.002	0.006	0.009

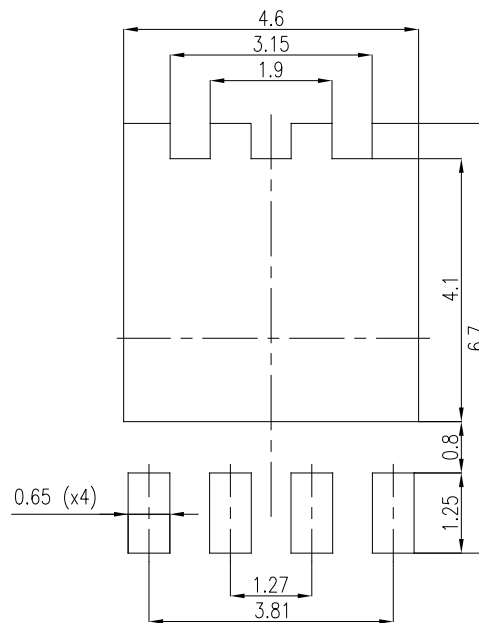
Figure 14. PowerFLAT 5x6 recommended footprint (dimensions are in mm)

Note: For packing information, please refer to [TN1173](#).

3 Ordering information

Table 7. Ordering information

Order code	Marking	Package	Weight	Base qty.	Delivery mode
STTH5R06DJF-TR	TH5R 06	PowerFLAT 5x6	0.095 g	3000	Tape and reel

Revision history

Table 8. Document revision history

Date	Revision	Changes
16-Mar-2012	1	Initial release.
12-Mar-2018	2	Updated package outline information.
05-Dec-2022	3	Updated Section Cover image, Figure 12. Thermal resistance junction to ambient versus copper surface under tab and Section 2.1 PowerFLAT 5x6 package information. Added Section Applications.
26-Jan-2023	4	Updated description title.

IMPORTANT NOTICE – READ CAREFULLY

STMicroelectronics NV and its subsidiaries (“ST”) reserve the right to make changes, corrections, enhancements, modifications, and improvements to ST products and/or to this document at any time without notice. Purchasers should obtain the latest relevant information on ST products before placing orders. ST products are sold pursuant to ST’s terms and conditions of sale in place at the time of order acknowledgment.

Purchasers are solely responsible for the choice, selection, and use of ST products and ST assumes no liability for application assistance or the design of purchasers’ products.

No license, express or implied, to any intellectual property right is granted by ST herein.

Resale of ST products with provisions different from the information set forth herein shall void any warranty granted by ST for such product.

ST and the ST logo are trademarks of ST. For additional information about ST trademarks, refer to www.st.com/trademarks. All other product or service names are the property of their respective owners.

Information in this document supersedes and replaces information previously supplied in any prior versions of this document.

© 2023 STMicroelectronics – All rights reserved