

DETAILS

Product Number	C13095_MELODY-3-M
Family	Melody
Type	Lens array
Color	clear
Diameter	50,6 mm
Height	11,9 mm
Style	round
Optic Material	PMMA
Holder Material	
Fastening	pin, glue
Status	production ready
ROHS Compliant	Yes
Date Updated	2/10/2013



OPTICAL PROPERTIES

LED	Viewing	Light	Effi-	cd/lm	Connector
	Angle	Beam	ciency		
XP-E	31 deg	Medium	93 %	2.260	-
XP-G	38 deg	Medium	92 %	1.780	-
XP-G2	41 deg	Medium	93 %	1.700	-
XT-E	33 deg	Medium	92 %	2.140	-
XP-E2	34 deg	Medium	92 %	1.900	-
LUXEON R	33 deg	Medium	92 %	2.000	-
LUXEON Rebel	31 deg	Medium	93 %	2.300	-
LUXEON A	39 deg	Medium	93 %	1.750	-
LUXEON Rebel ES	37 deg	Medium	92 %	1.930	-
LUXEON T	37 deg	Medium	92 %	1.700	-
LUXEON H50-2	sim: 36	Medium	sim: 92 %	sim: 2.000	-
LUXEON TX	31 deg	Medium	91 %	2.300	-
LUXEON Z ES	25 deg	Medium	90 %	3.100	-
NCSxx19A	29.5 deg	Medium	92 %	2.520	-
NVSxx19B/NVSxx19C	34 deg	Medium	92 %	2.140	-
NCSxx19B	31 deg	Medium	91 %	2.400	-
Oslo SSL 80	29 deg	Medium	92 %	2.330	-
Oslo SSL 150	31 deg	Medium	93 %	2.470	-
Oslo Square EC	40 deg	Medium	92 %	1.740	-

Relative intensity of C13095_MELODY-3-M (Rebel)

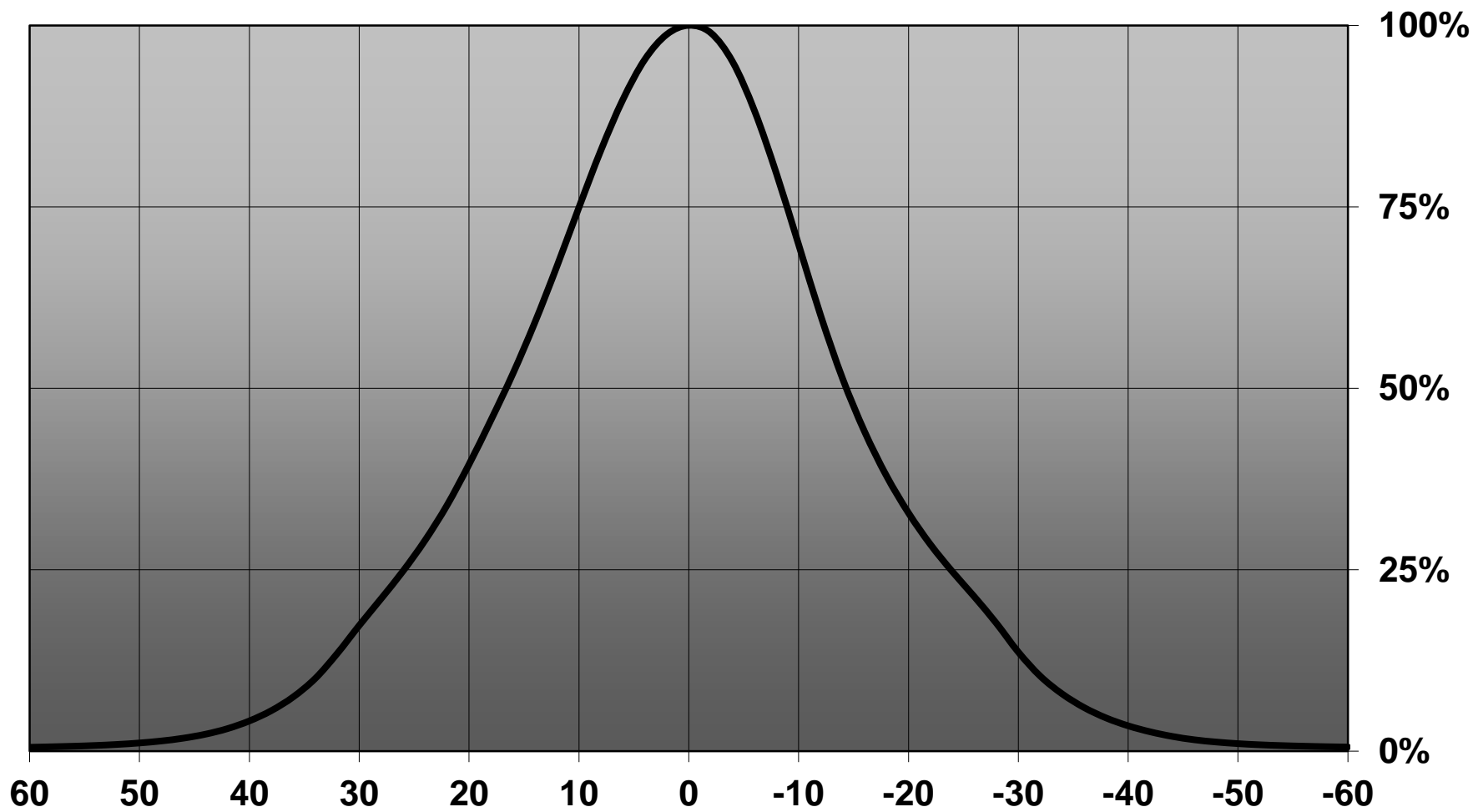

Relative intensity of C13095_MELODY-3-M (Rebel-ES)

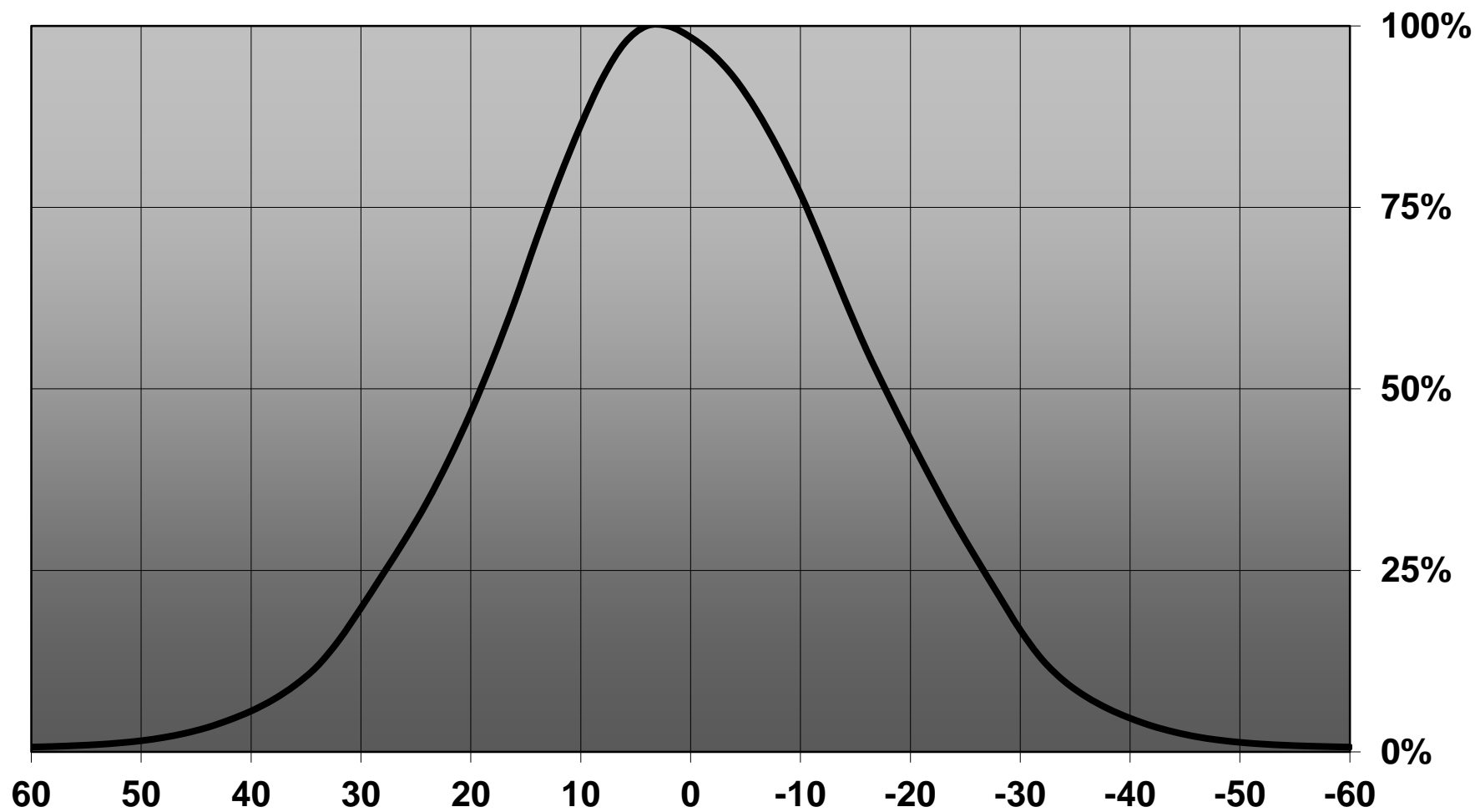

Relative intensity of C13095_MELODY-3-M_(Luxeon_Z_ES)

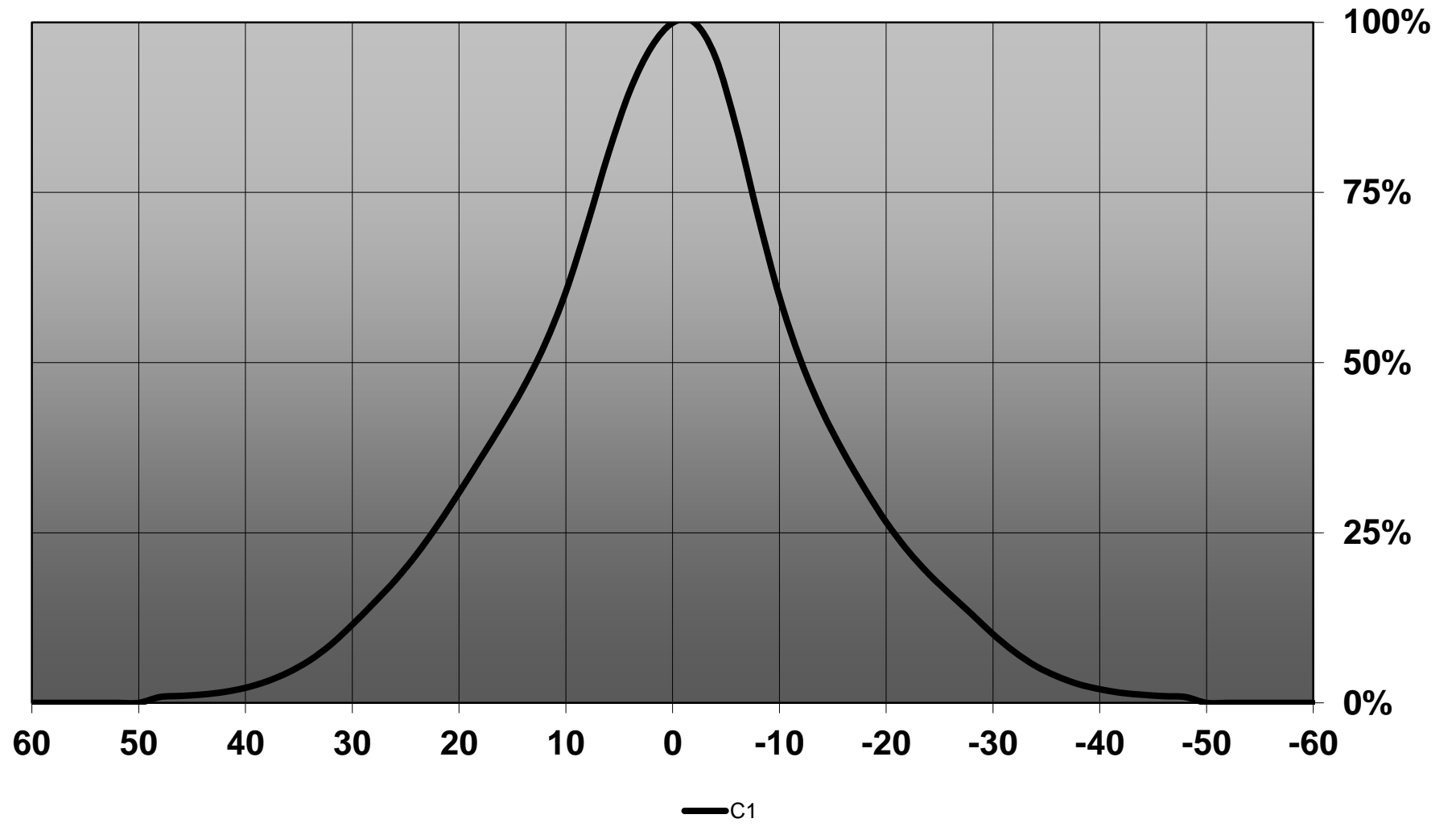

D

C

B

A

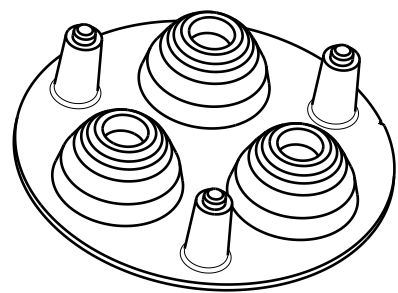
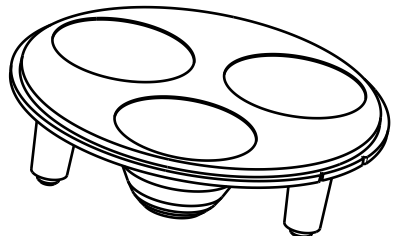

Isometric view

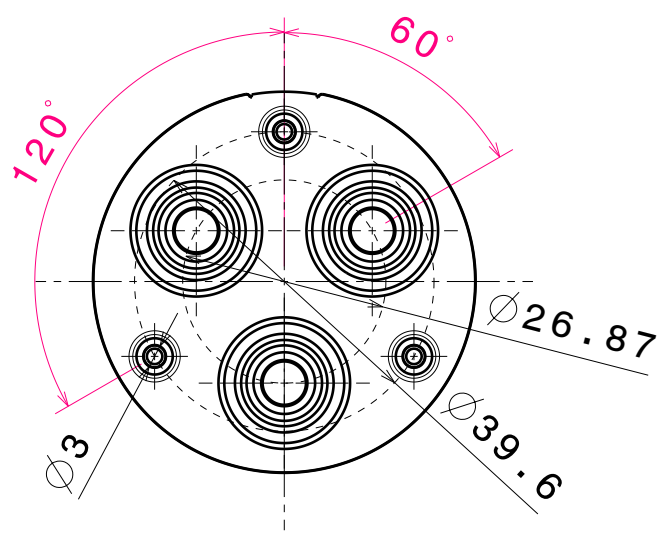

Bottom view

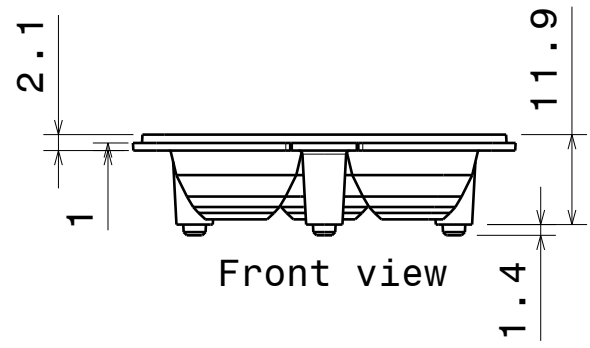

Front view

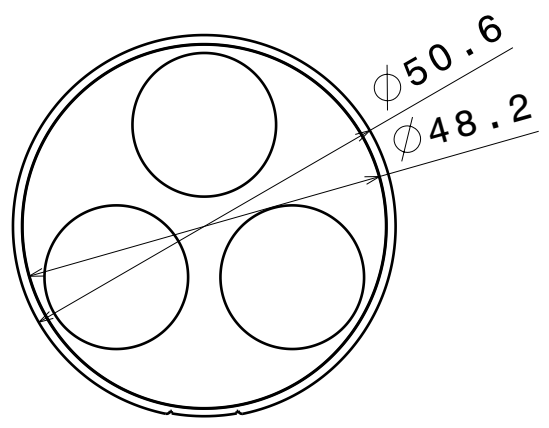

Top view

Material: PMMA

Tolerances for dimensions:
 0-20mm tolerance value $\pm 0.1\text{mm}$
 21-45mm tolerance value $\pm 0.2\text{mm}$
 46-90mm tolerance value $\pm 0.3\text{mm}$
 91-100mm tolerance value $\pm 0.4\text{mm}$
 101-150mm tolerance value $\pm 0.5\text{mm}$

This drawing is our property.
 It can't be reproduced
 or communicated without
 our written agreement.



Ledil Oy
 Salorankatu 10
 FIN 24240 SALO
 Finland

DRAWING TITLE

Datasheet C13095_MELODY-3-M

DRAWN BY
 mav

DATE
 21.08.2012

CHECKED BY
 pv

DATE
 21.08.2012

SIZE
 A4

DRAWING NUMBER
 C13095

REV
 1

DESIGNED BY
 mav

DATE
 15.08.2012

SCALE 1:1

WEIGHT (g)

SHEET

1 / 1

D

A

4

4

3

3

2

2

1

1

Luminaire: LEDiL C13095_MELODY-3-M_(XP-E) Eff. 93%
Lamps: 1 x Cree XP-E (156.4lm@250mA)

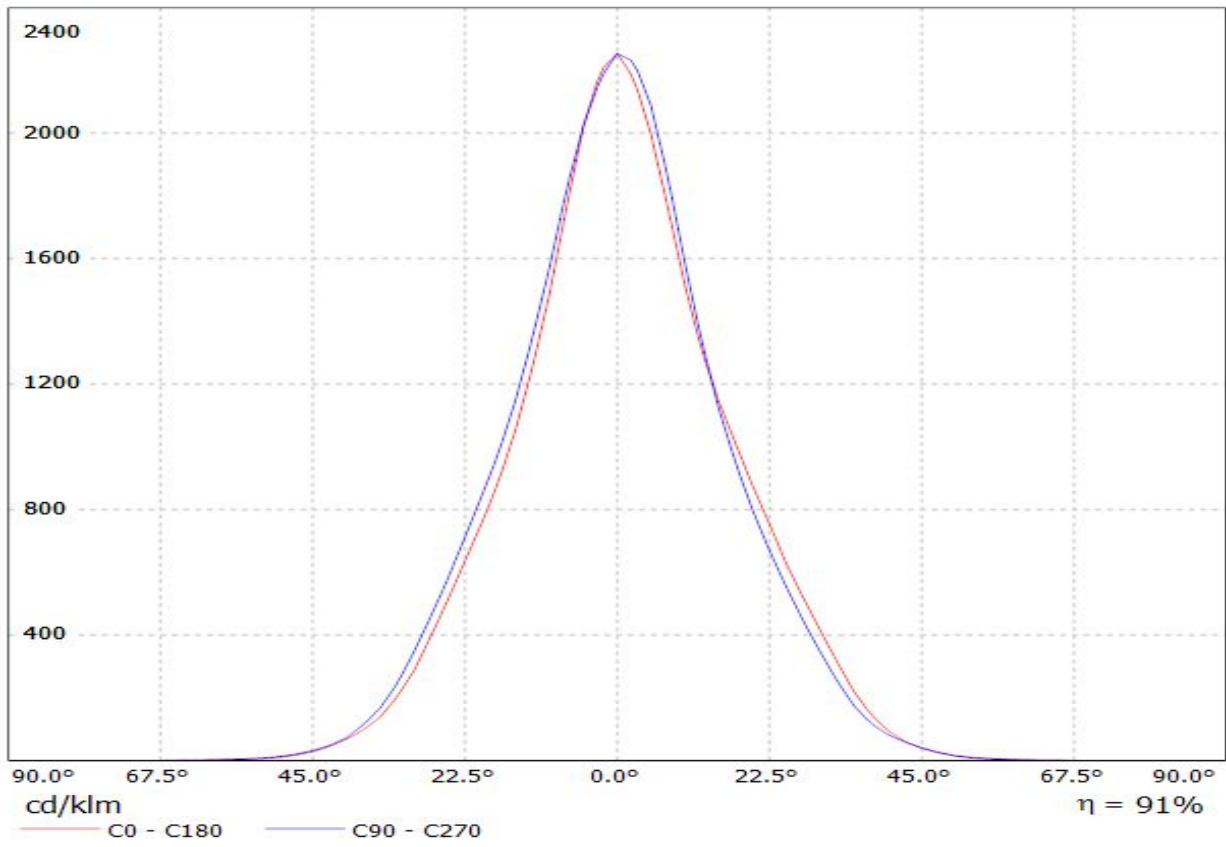

Luminaire: LEDiL C13095_MELODY-3-M_(XP-G) Eff.92%
Lamps: 1 x Cree XP-G (200lm@250mA)

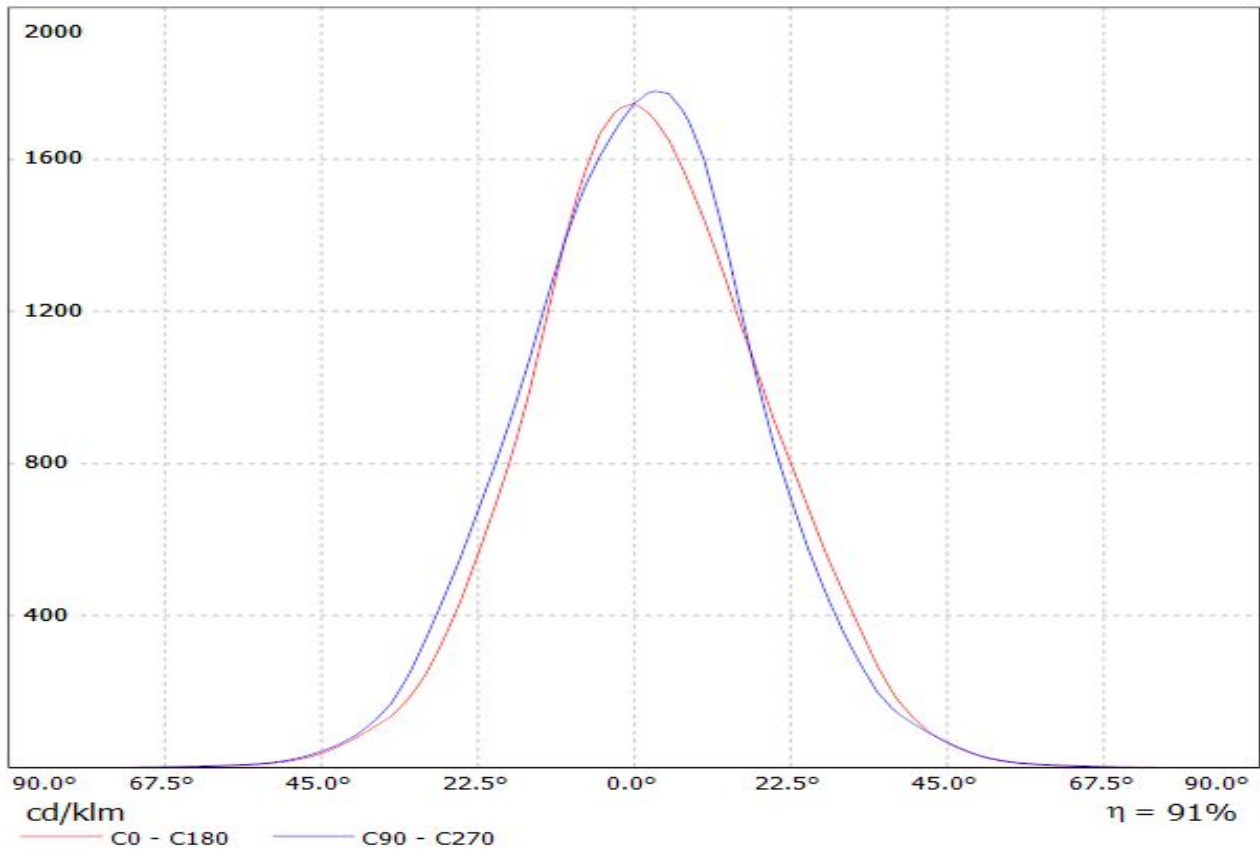

Luminaire: LEDiL C13095_MELODY-3-M_(XP-G2) Eff. 93%
Lamps: 1 x Cree XP-G2 (322lm@250mA)

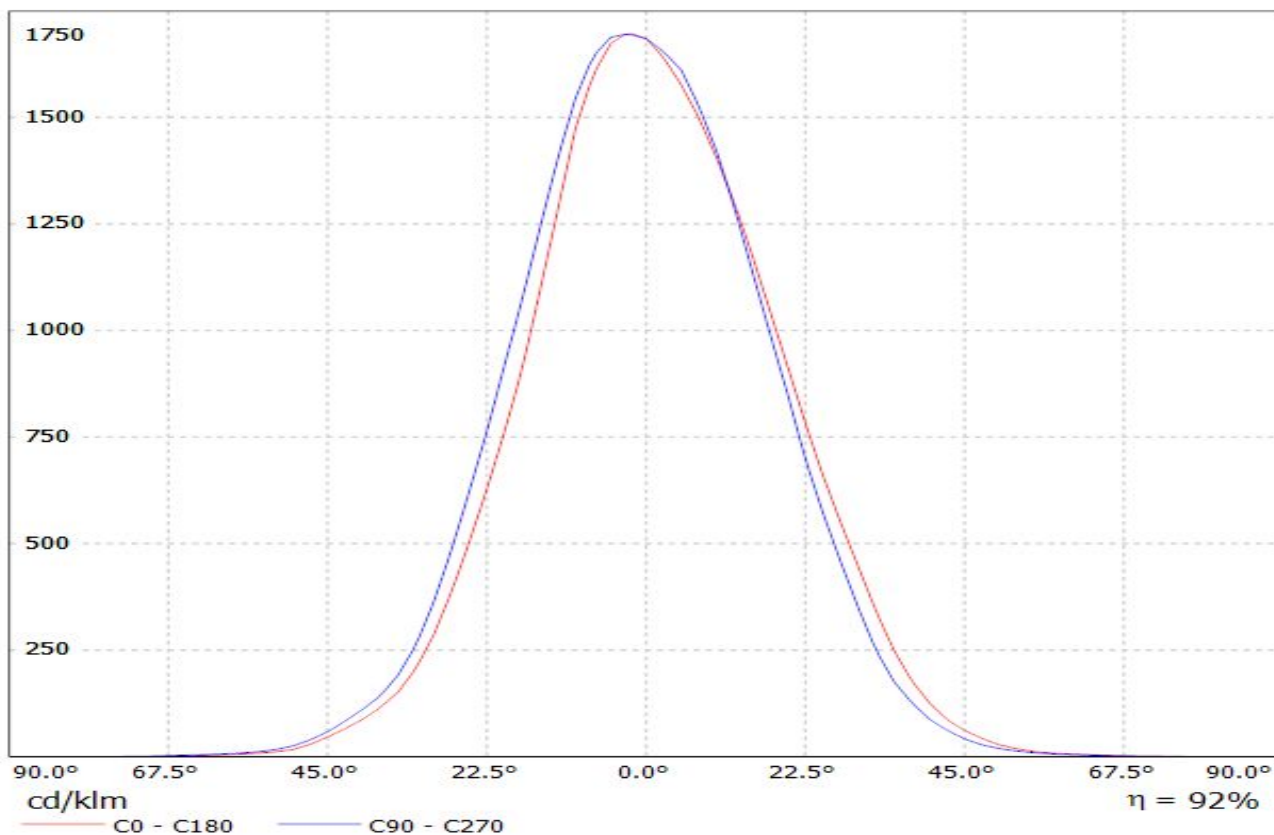

Luminaire: LEDiL C13095_MELODY-3-M_(XT-E) Eff.92%
Lamps: 1 x Cree XT-E (230lm@250mA)

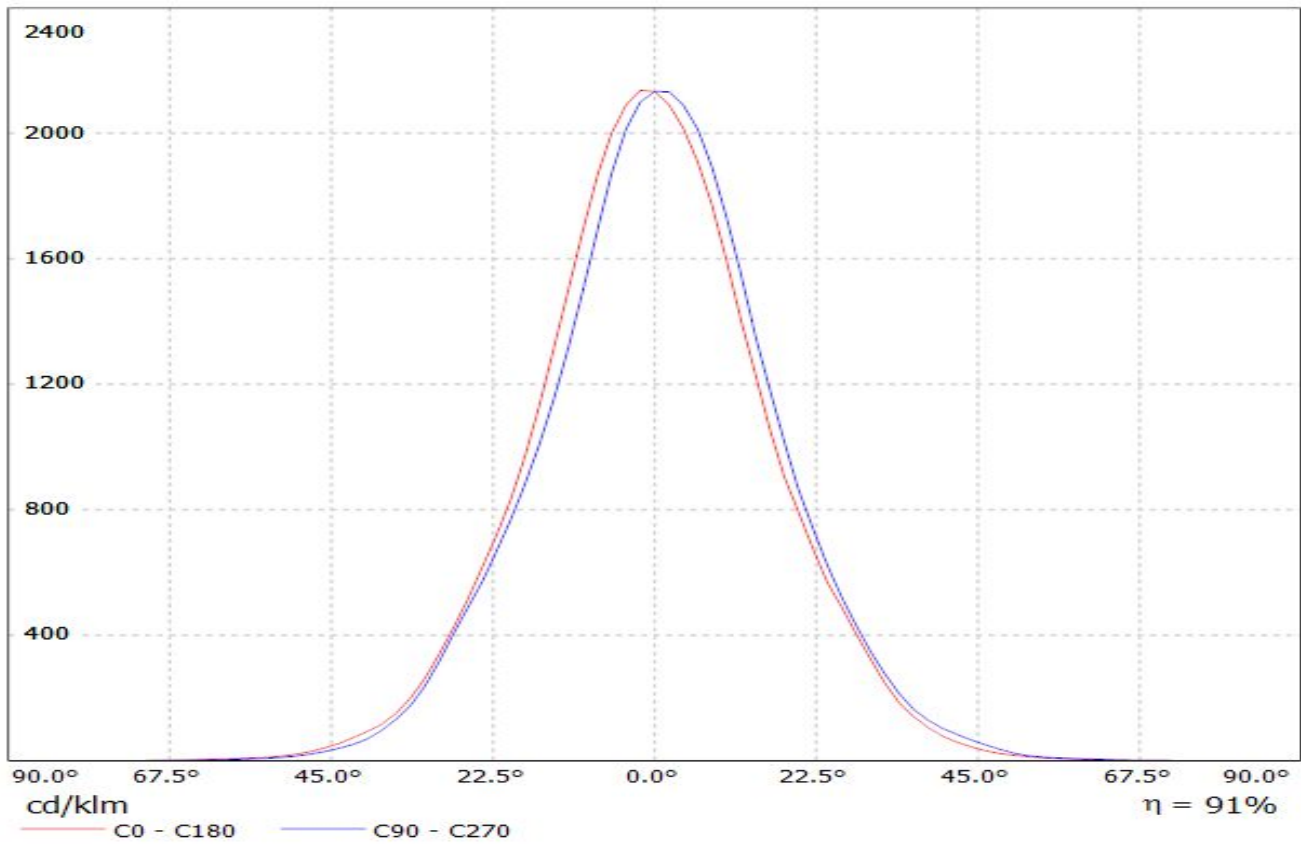

Luminaire: LEDiL Oy C13095_MELODY-3-M_(XP-E2) Eff:92%
Lamps: 1 x CREE_XP-E2-MELODY_3_255.522lm@250mA_P=2.21794W_I=249.9mA

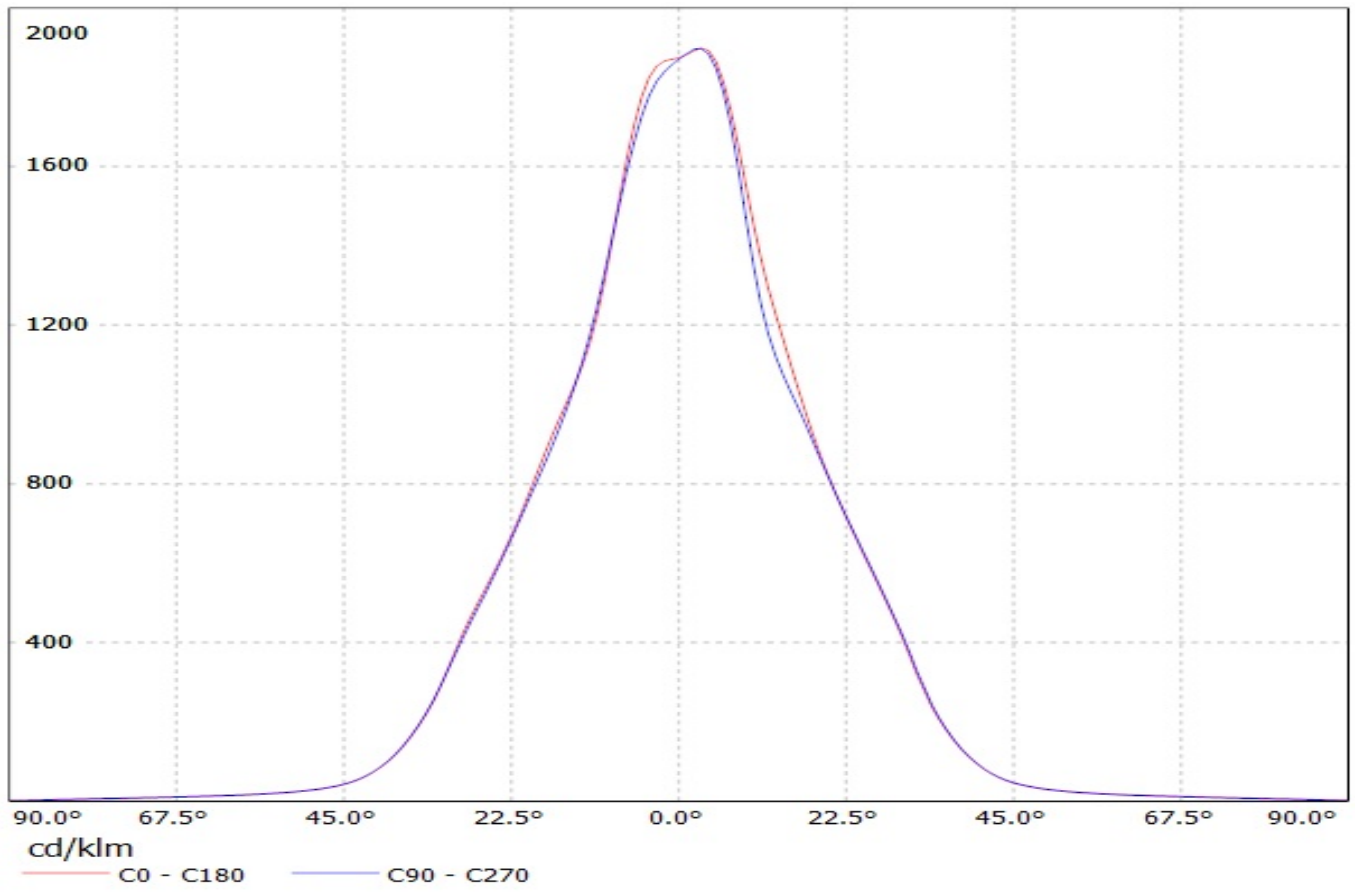

Luminaire: LEDiL Oy C13095_MELODY-3-M_(Luxeon_R) Eff.92.0%
Lamps: 1 x Luxeon_R (258.787lm@250mA)

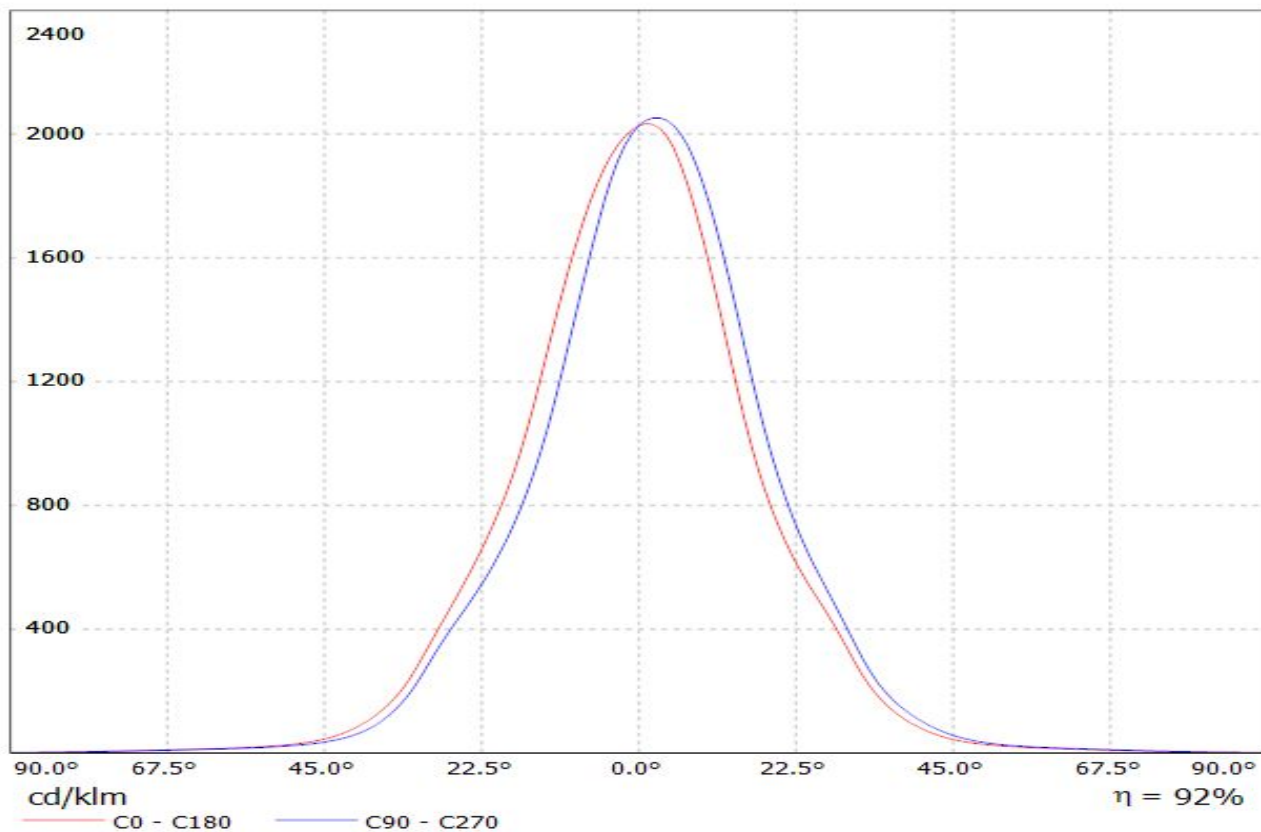

Luminaire: LEDiL Luminaire Catalog Number C13095_MELODY-3-M_(Rebel) Eff. 93%
Lamps: 1 x Luxeon Rebel (183lm@250mA)

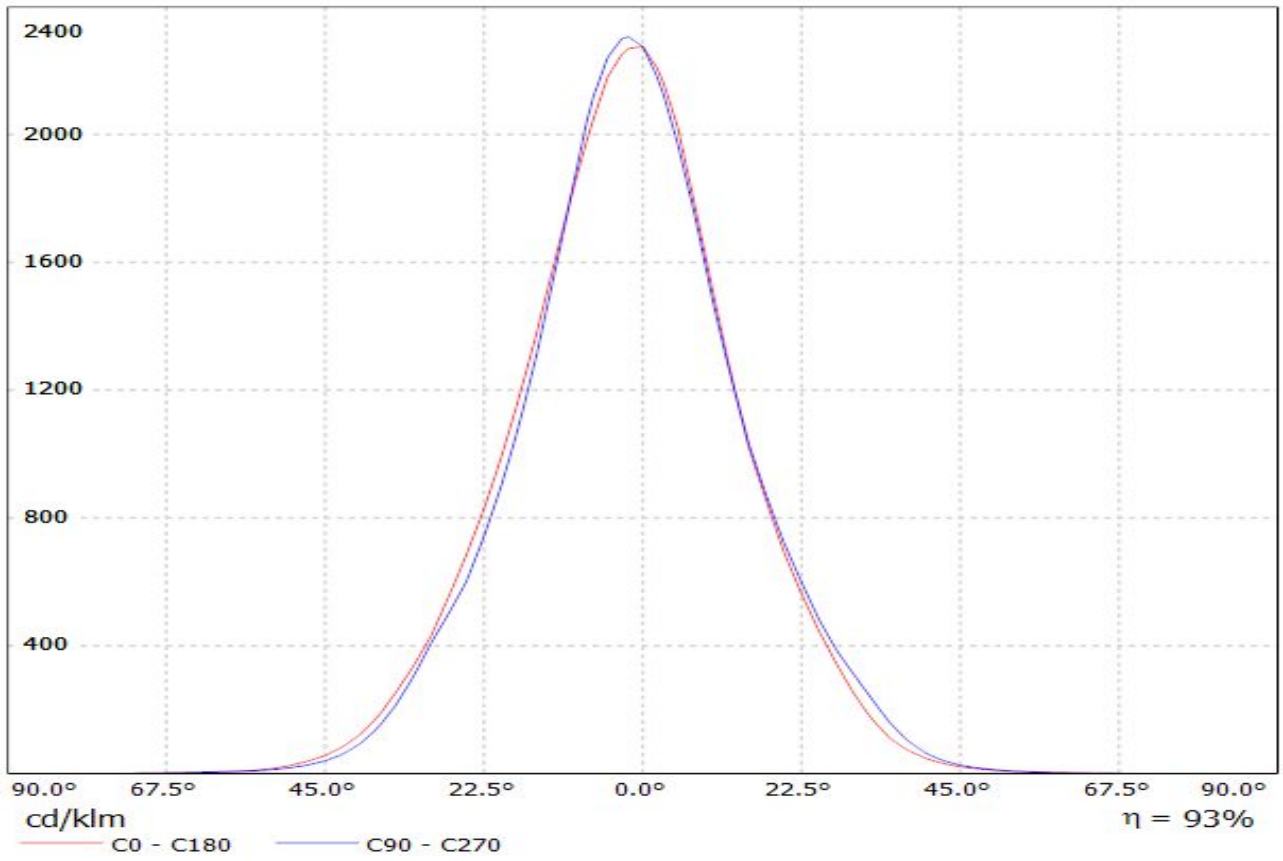

Luminaire: LEDiL C13095_MELODY-3-M_(Luxeon_A) Eff.93%
Lamps: 1 x Luxeon A (193lm@250mA)

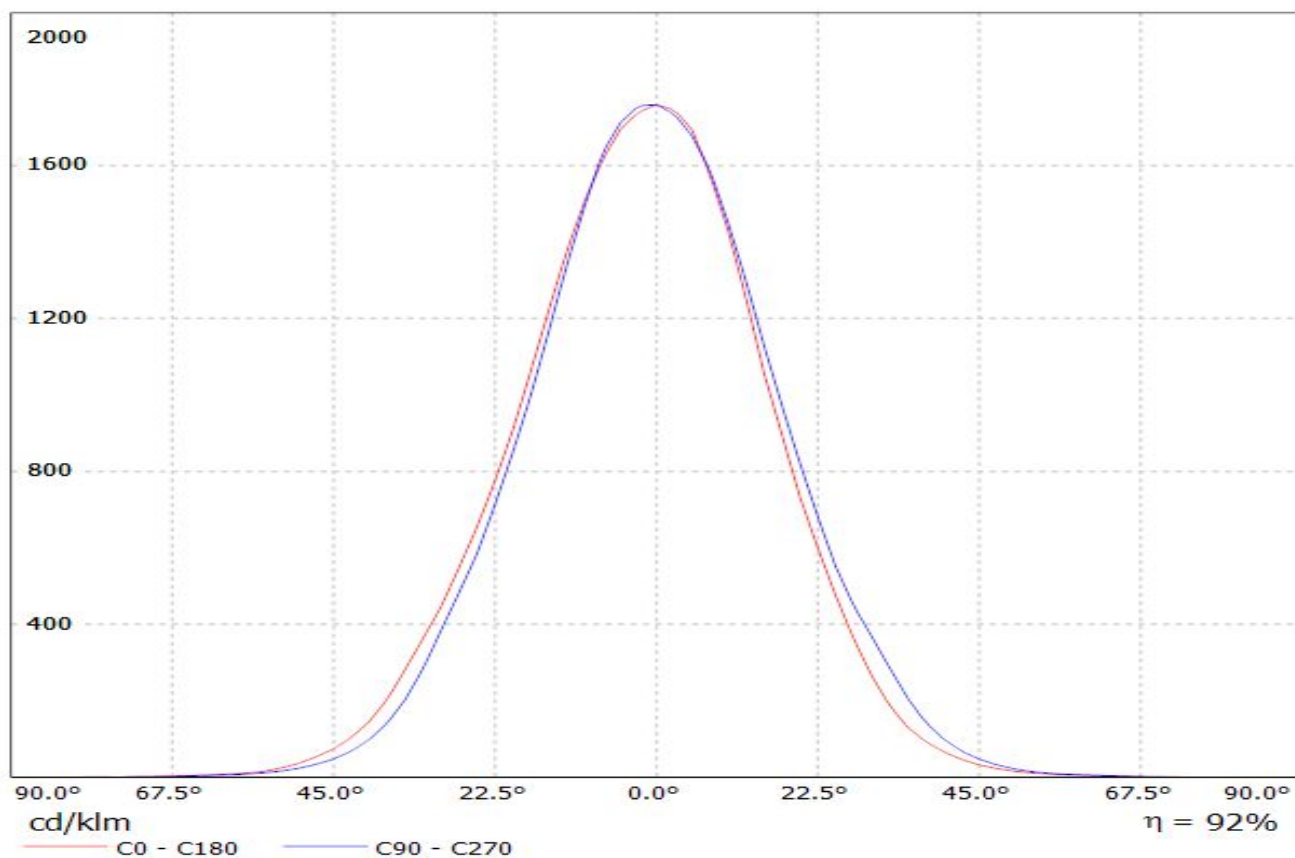

Luminaire: LEDiL C13095_MELODY-3-M_(RE-ES) Eff. 92%
Lamps: 1 x Luxeon Rebel-ES (200lm@250mA)

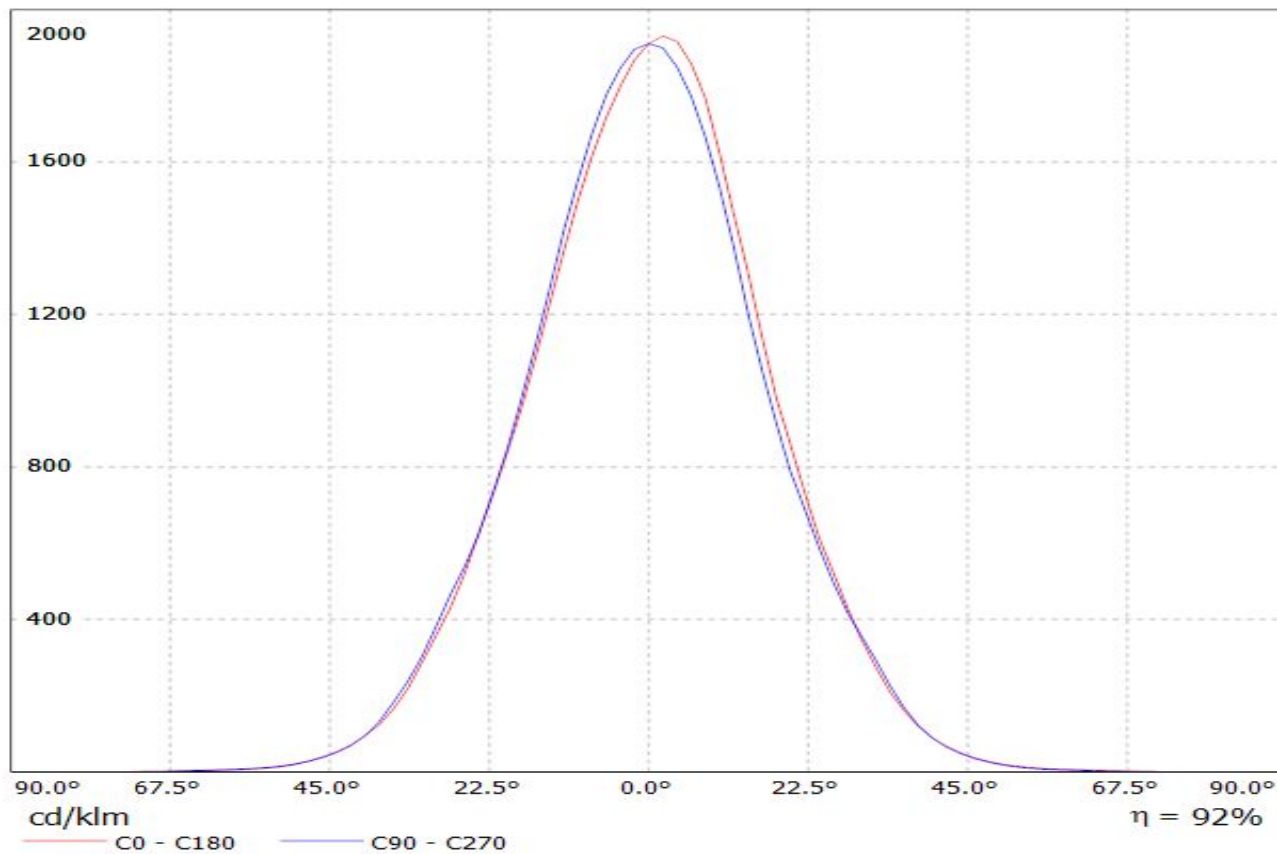

LEDiL Oy C13095_MELODY-3-M_(LUXEON_T) Eff.91.8% / LDC (Linear)

Luminaire: LEDiL Oy C13095_MELODY-3-M_(LUXEON_T) Eff.91.8%
Lamps: 1 x LUXEON_T (220lm@250mA)

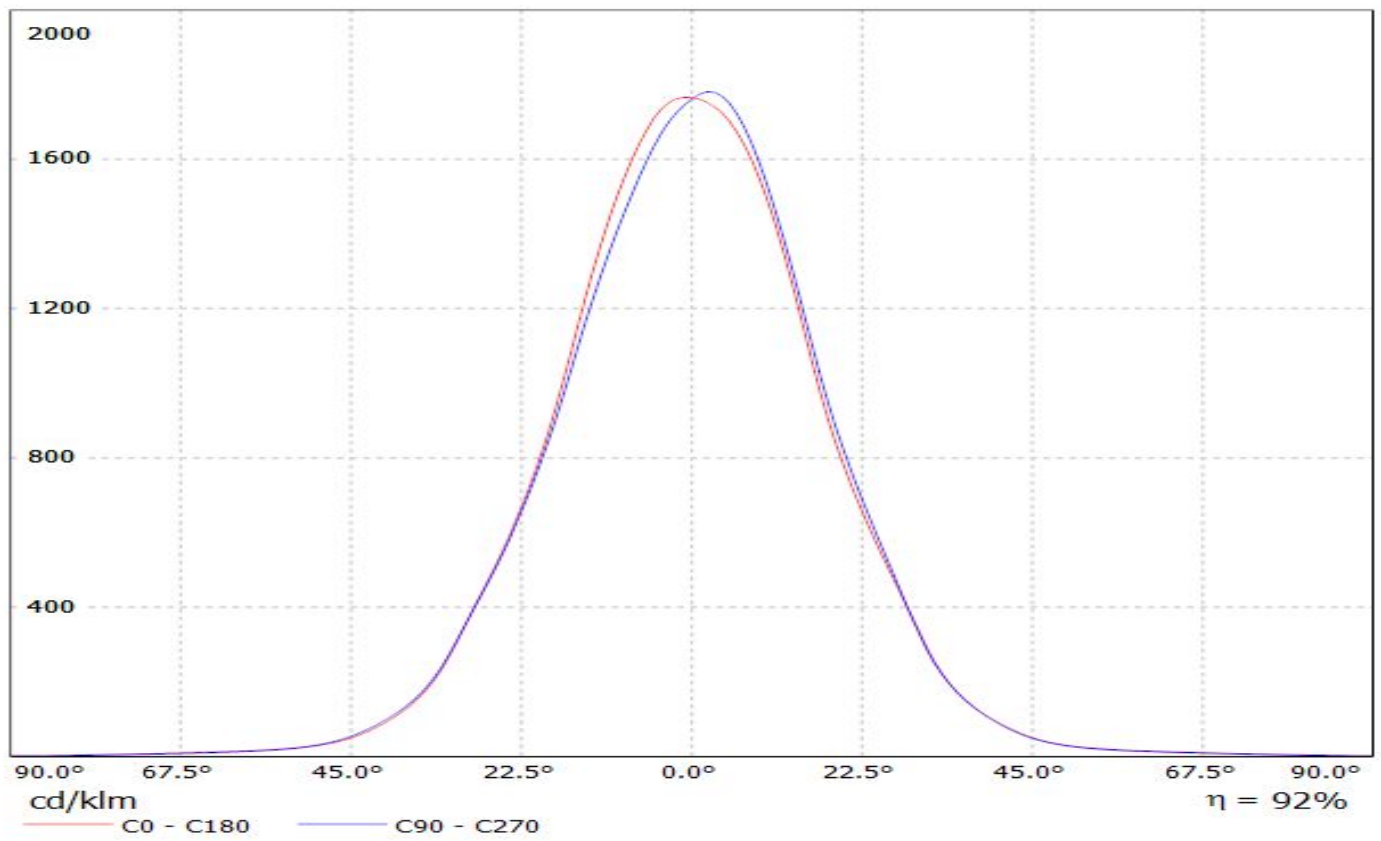

Luminaire: LEDiL C13095_MELODY-3-M_(NCS19) Eff. 92%
Lamps: 1 x Nichia NCS19 (257lm@250mA)

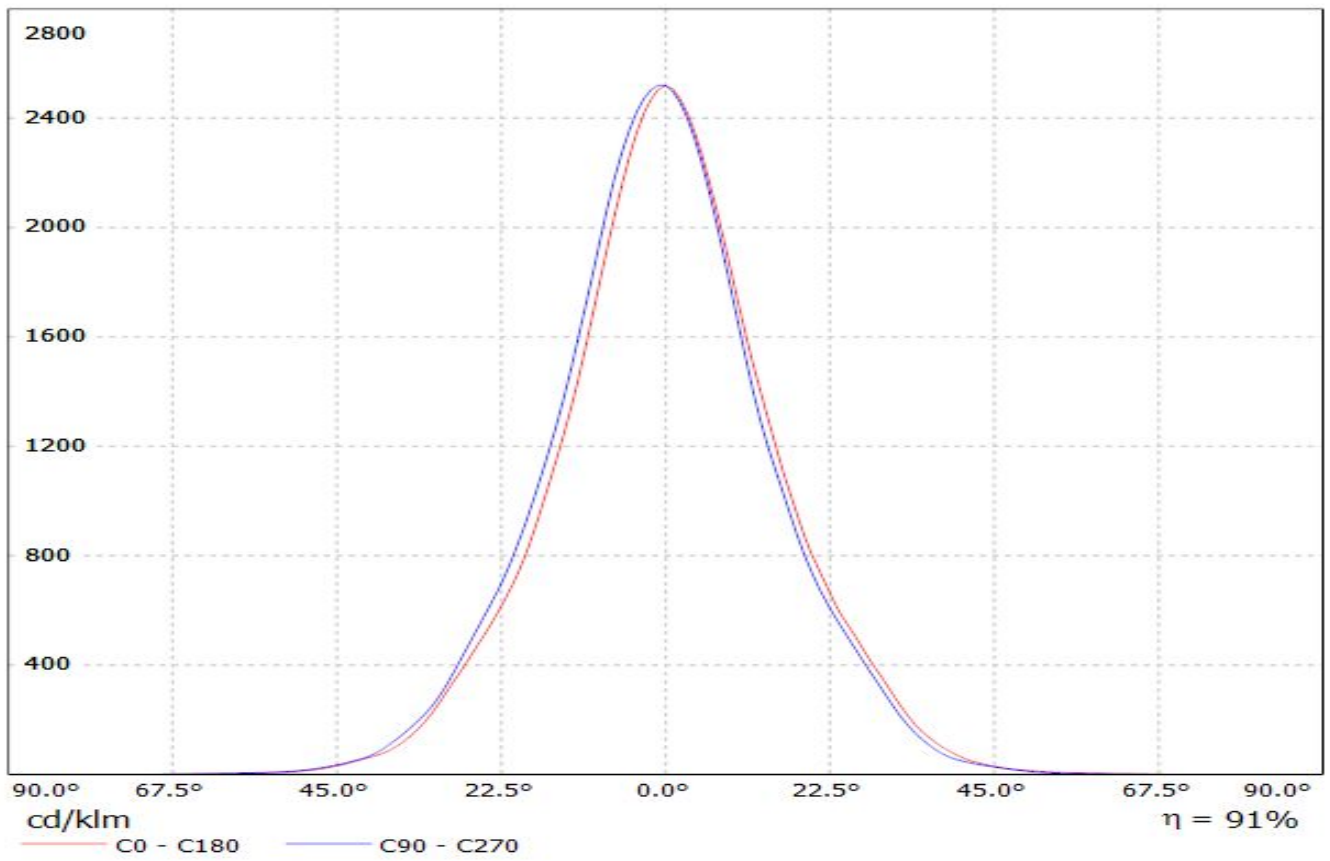

Luminaire: LEDiL C13095_MELODY-3-M Eff. 92%
Lamps: 1 x Nichia NVSL219BE (228lm@250mA)

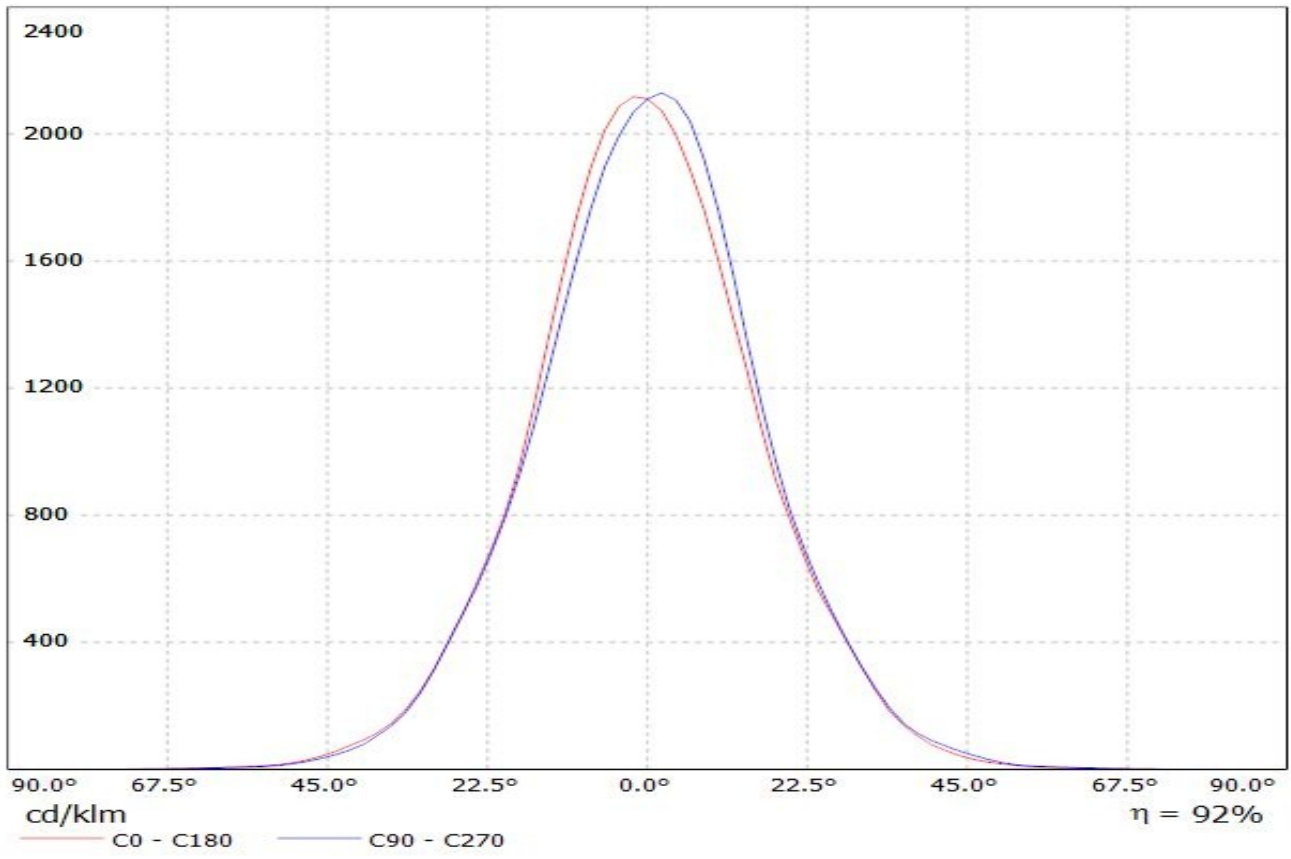

Luminaire: Ledil Oy C13095_MELODY-3-M_(NCSxx19B) Efficiency=91%
Lamps: 1 x Nichia NCSxx19B (NCSL119BE) 272lm @ 250mA CCT=3000K P=2.3W I=250mA

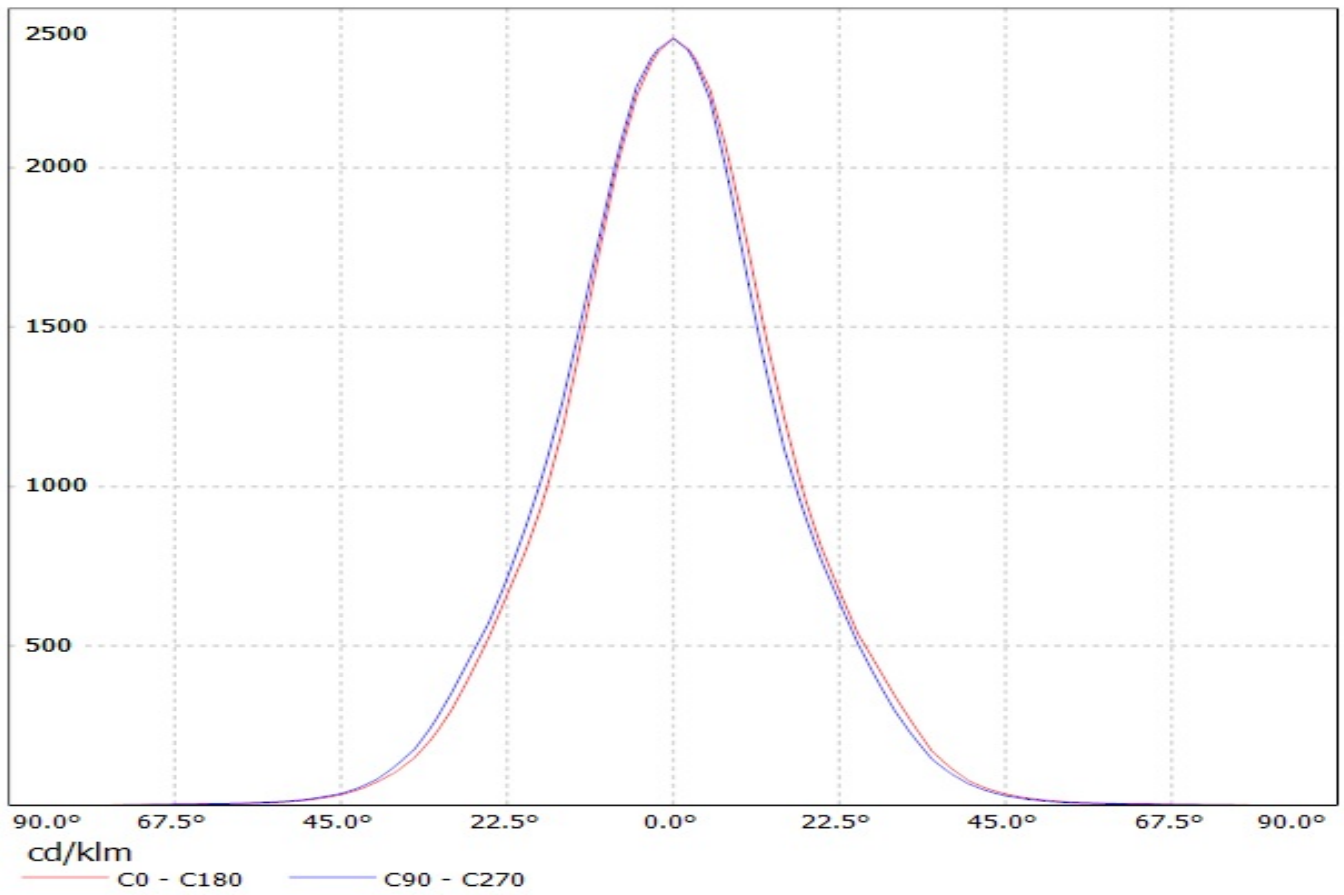

Luminaire: LEDiL C13095_MELODY-3-M_(SSL80) Eff 92%
Lamps: 1 x Oslon SSL80 (203lm@250mA)

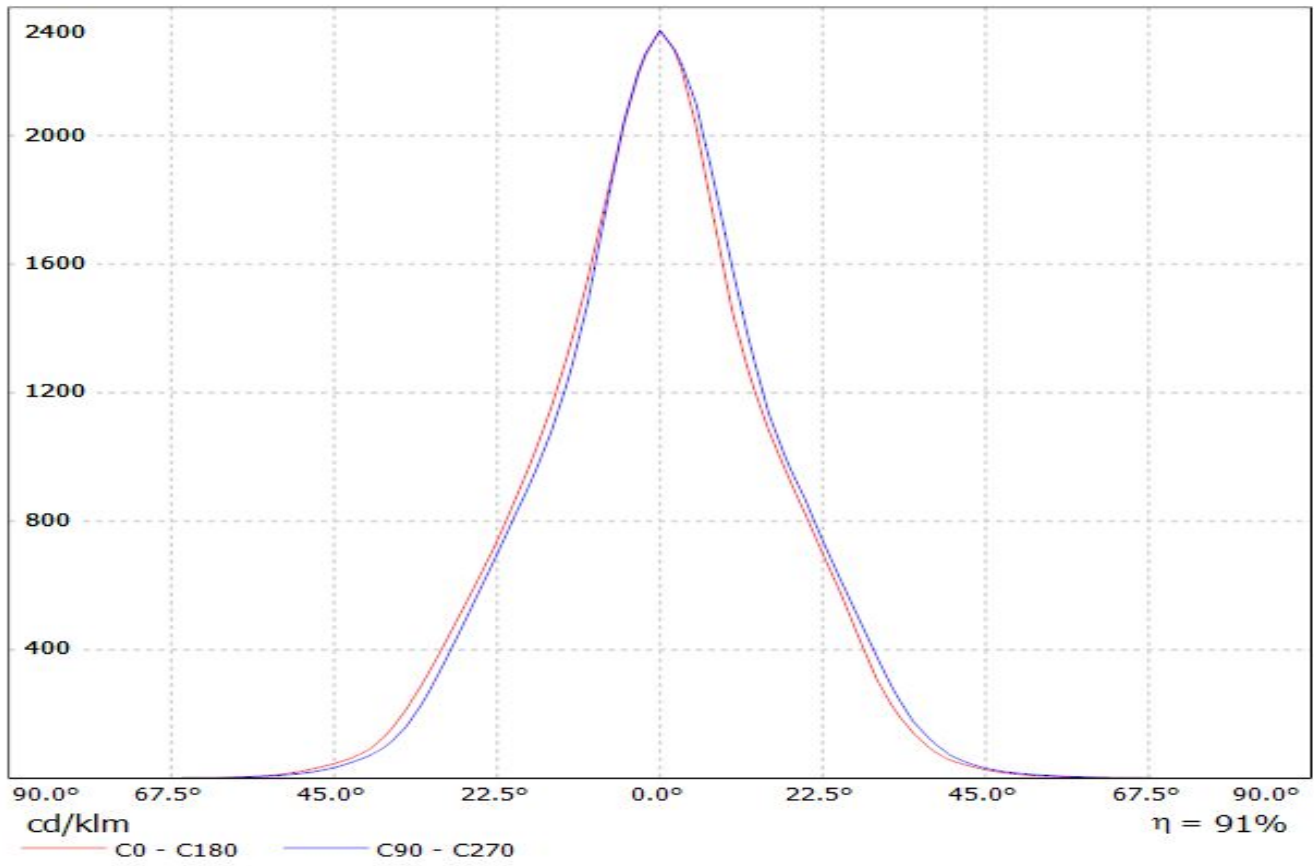

Luminaire: LEDiL C13095_MELODY-3-M_(SSL150) Eff.93%
Lamps: 1 x Oslon SSL150 (326lm@250mA)

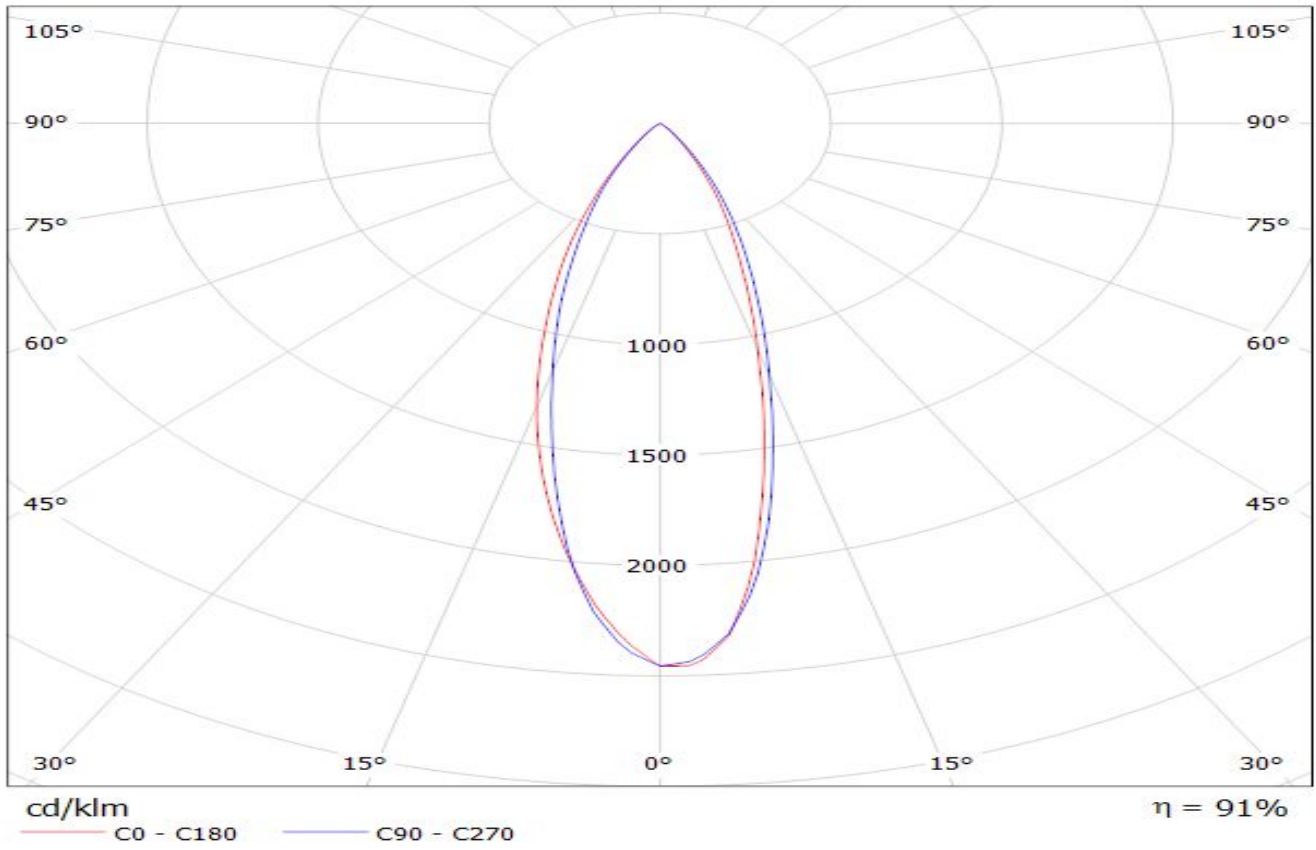

Luminaire: LEDiL C13095_MELODY-3-M_(Square_EC) Eff. 92%
Lamps: 1 x Osram Square EC (277lm@250mA)

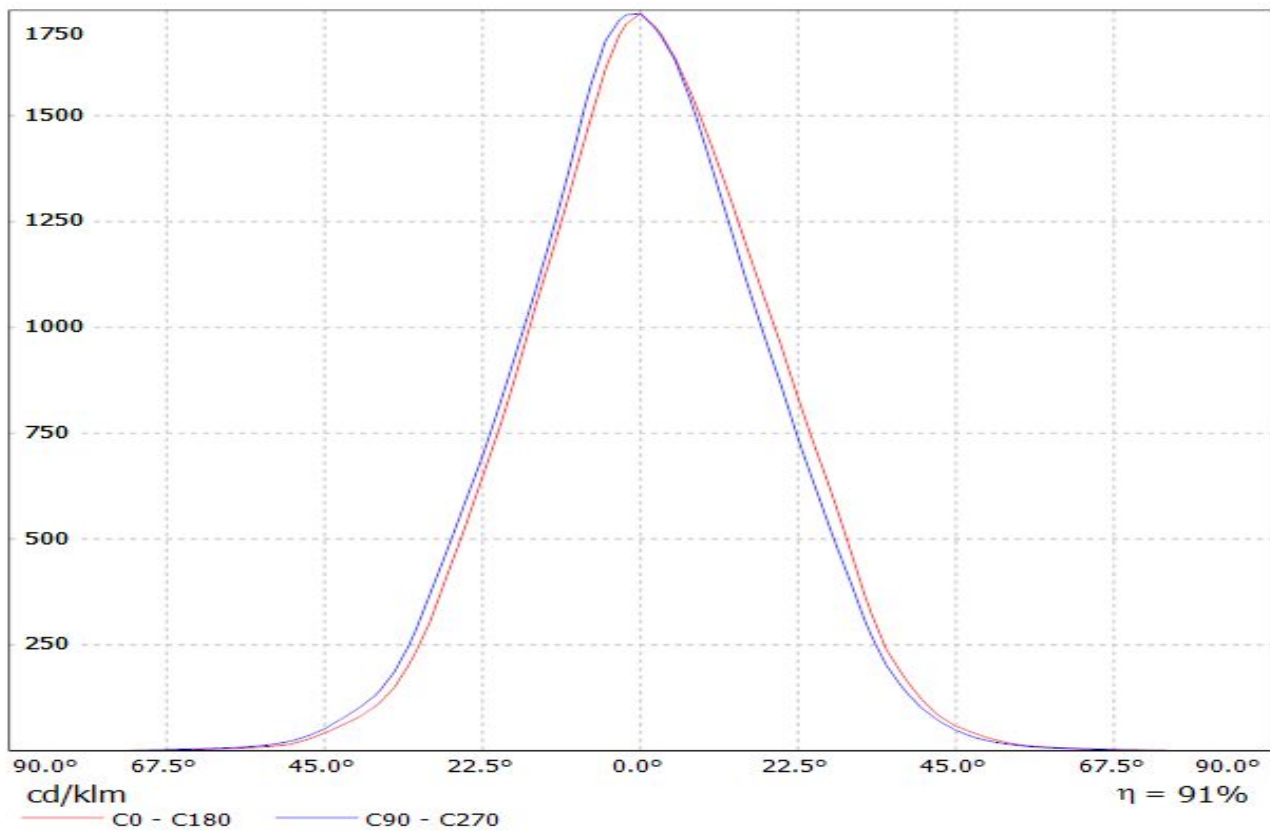

Luminaire: LEDiL C13095_MELODY-3-M_(XP-E) Eff. 93%
Lamps: 1 x Cree XP-E (156.4lm@250mA)

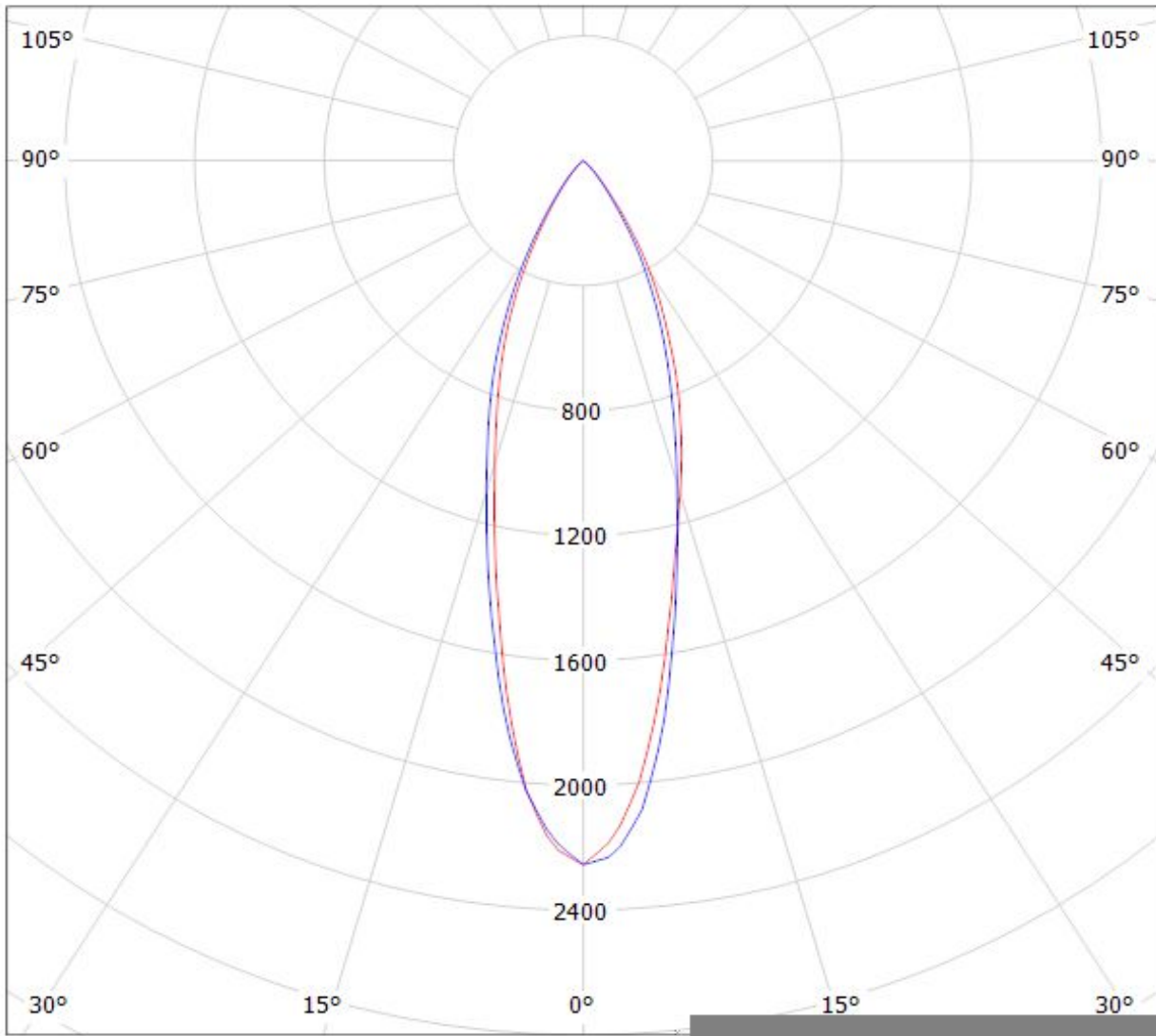

Luminaire: LEDiL C13095_MELODY-3-M_(XP-G) Eff.92%
Lamps: 1 x Cree XP-G (200lm@250mA)

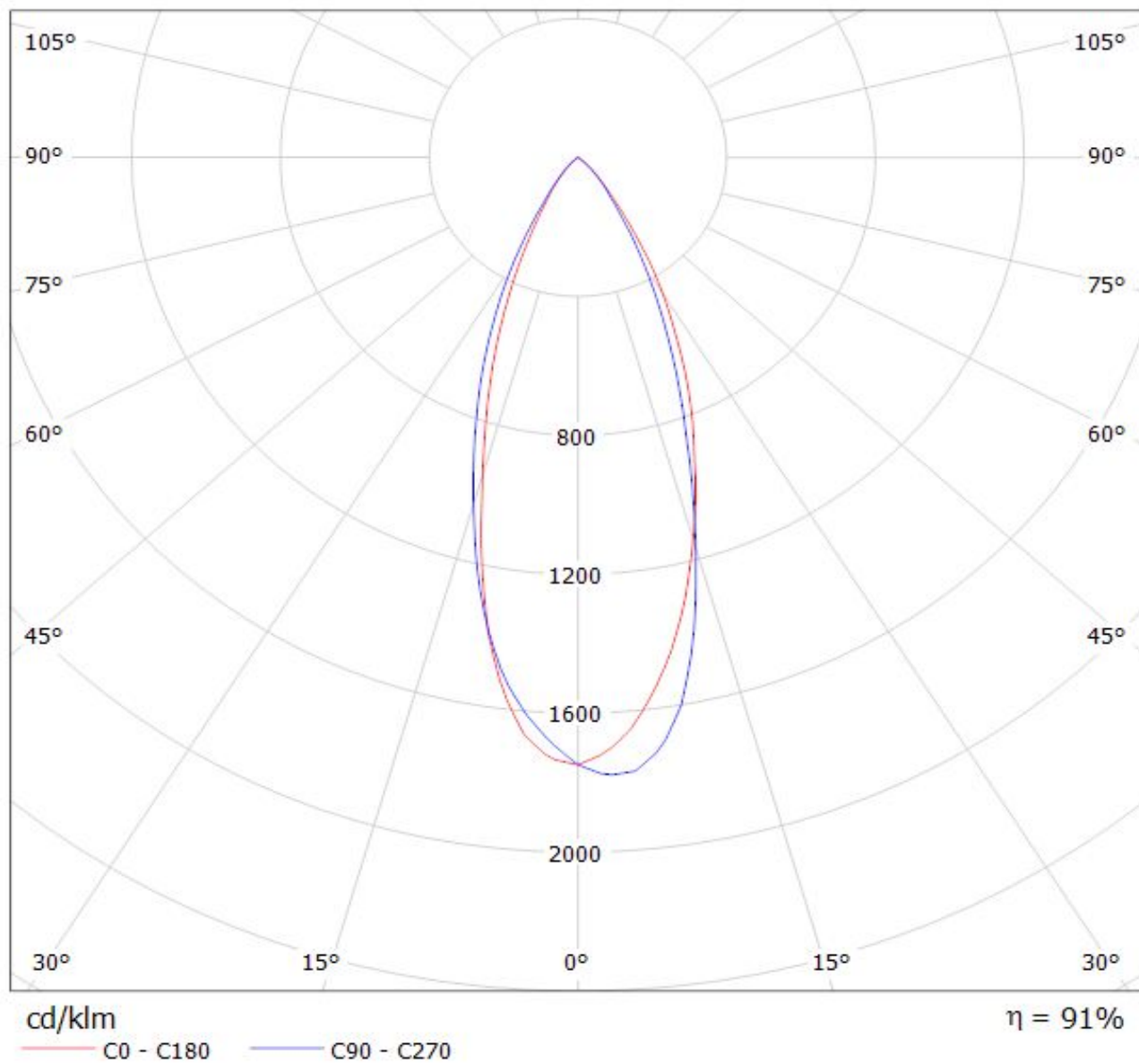

Luminaire: LEDiL C13095_MELODY-3-M_(XP-G2) Eff. 93%
Lamps: 1 x Cree XP-G2 (322lm@250mA)

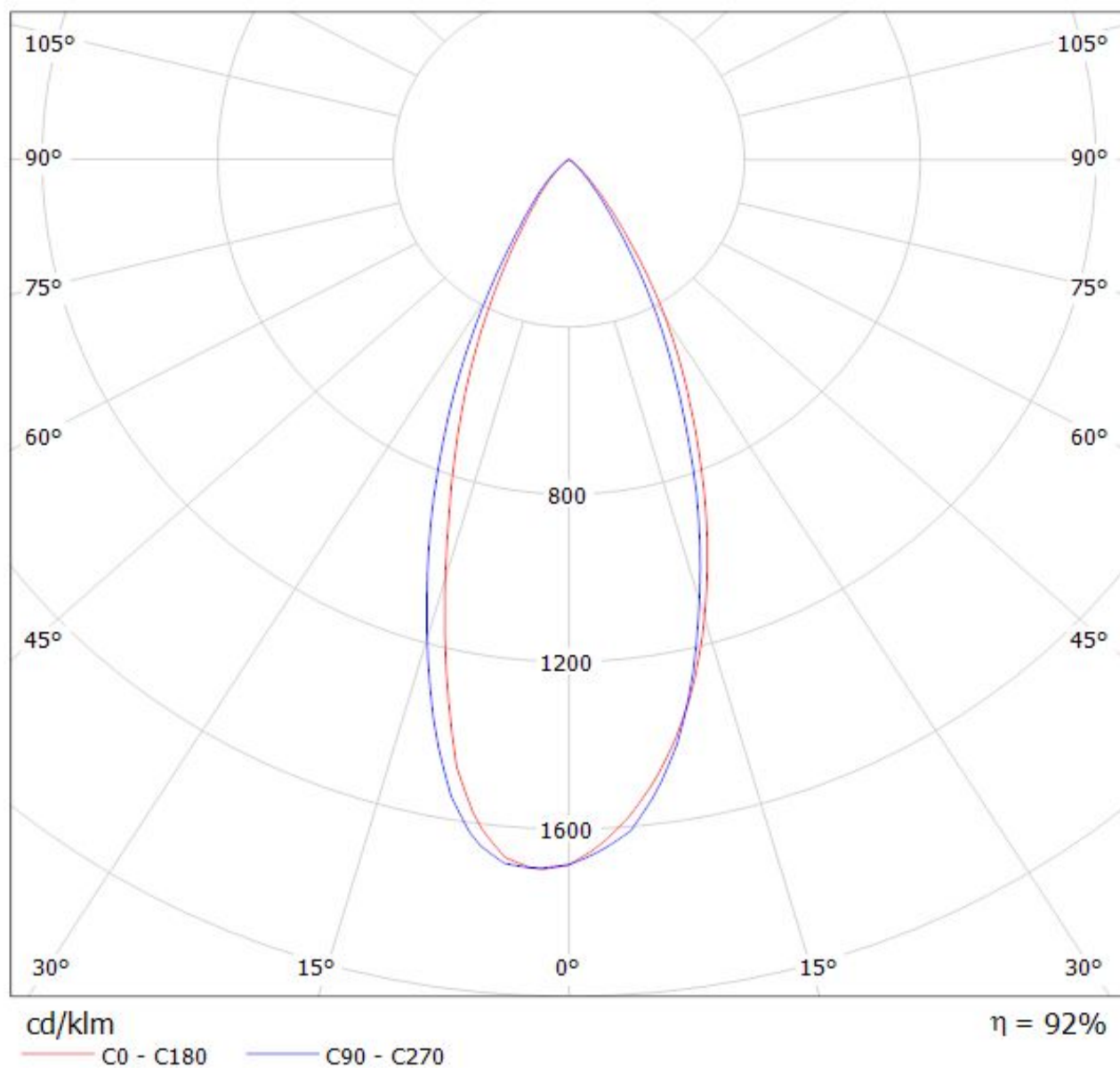

Luminaire: LEDiL C13095_MELODY-3-M_(XT-E) Eff.92%
Lamps: 1 x Cree XT-E (230lm@250mA)

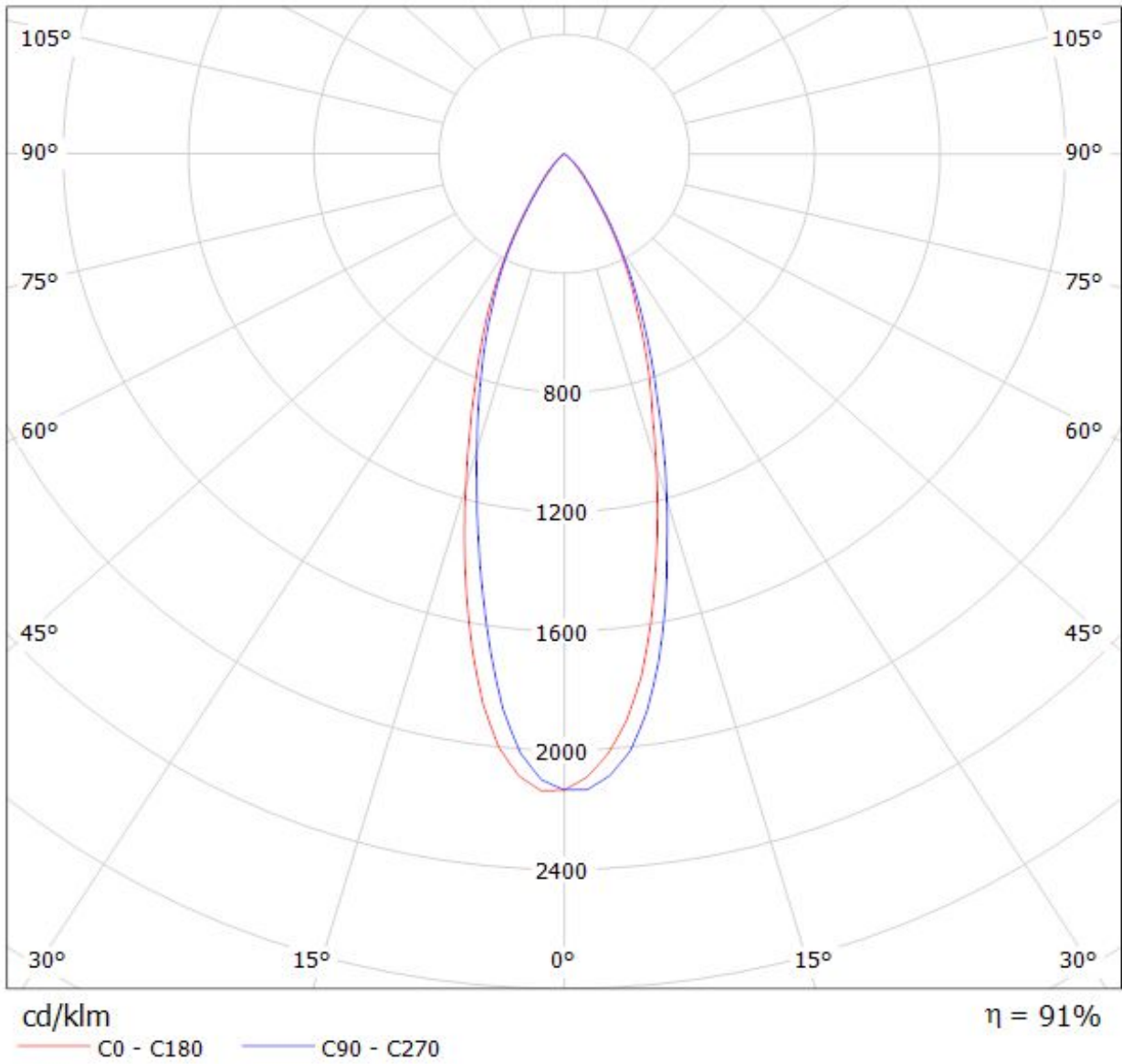

Luminaire: LEDiL Oy C13095_MELODY-3-M_(XP-E2) Eff:92%

Lamps: 1 x CREE_XP-E2-MELODY_3_255.522lm@250mA_P=2.21794W_I=249.9mA

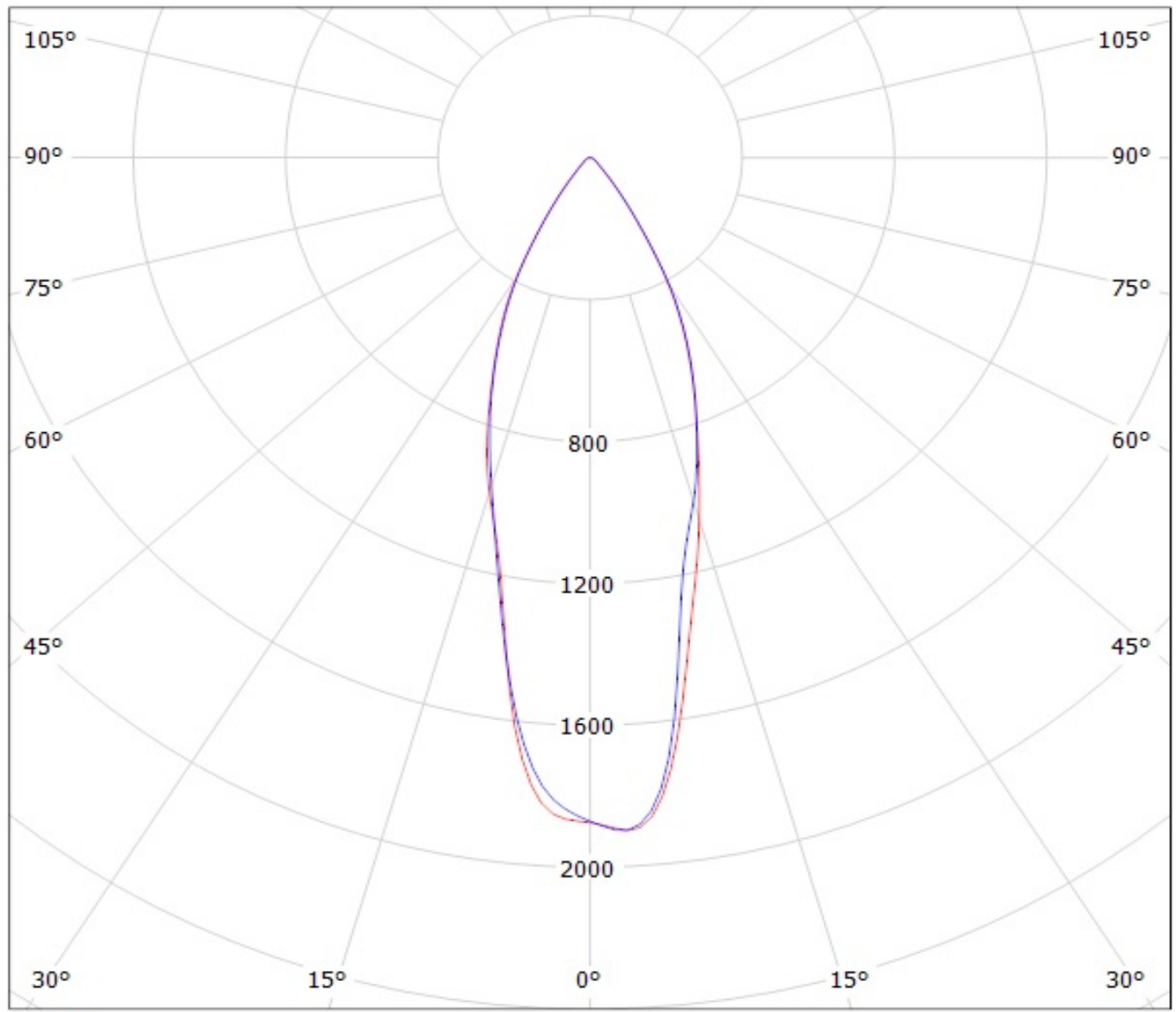

cd/klm

— C0 - C180

— C90 - C270

Luminaire: LEDiL Oy C13095_MELODY-3-M_(Luxeon_R) Eff.92.0%
Lamps: 1 x Luxeon_R (258.787lm@250mA)

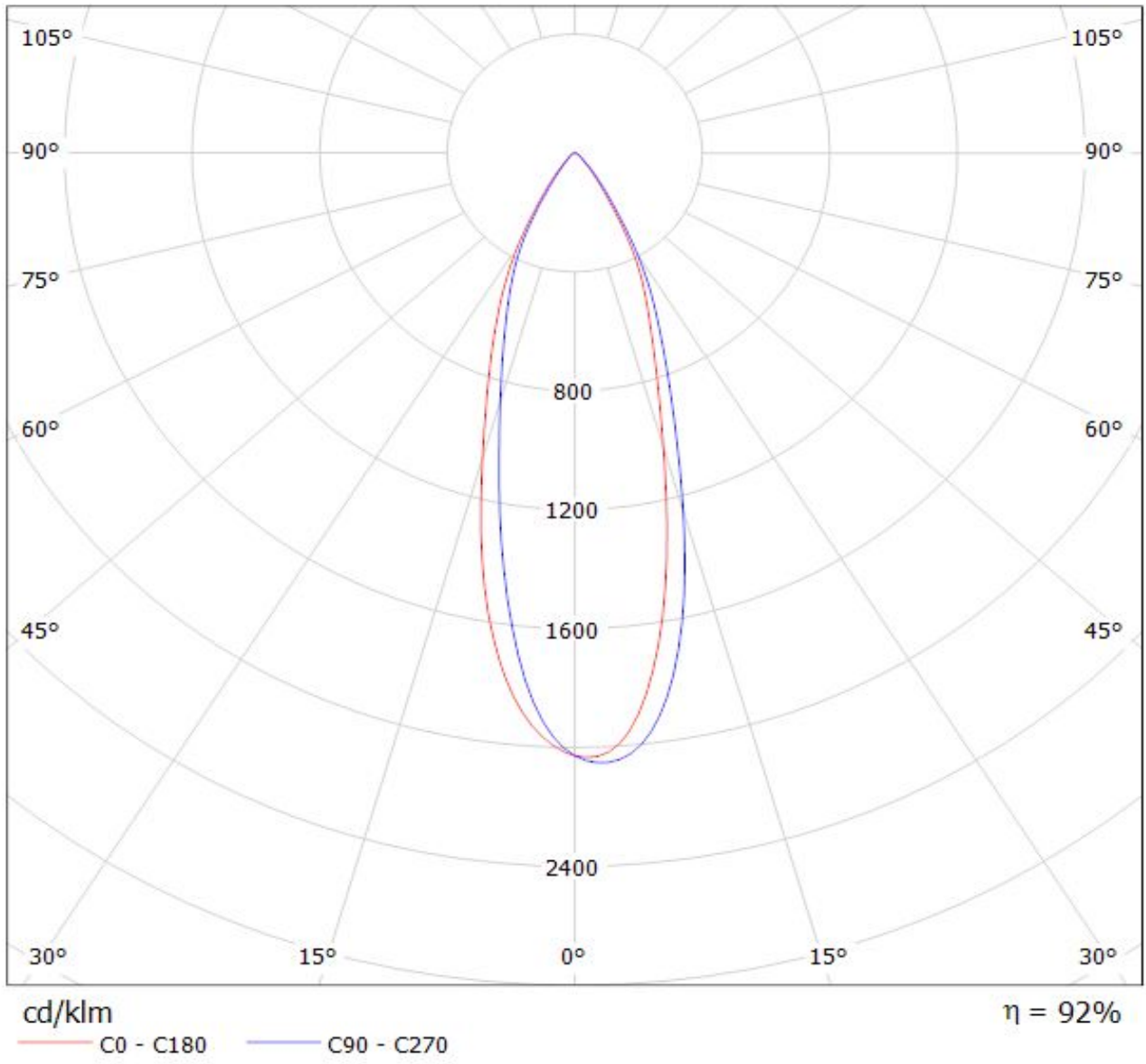

Luminaire: LEDiL Luminaire Catalog Number C13095_MELODY-3-M_(Rebel) Eff. 93%
Lamps: 1 x Luxeon Rebel (183lm@250mA)

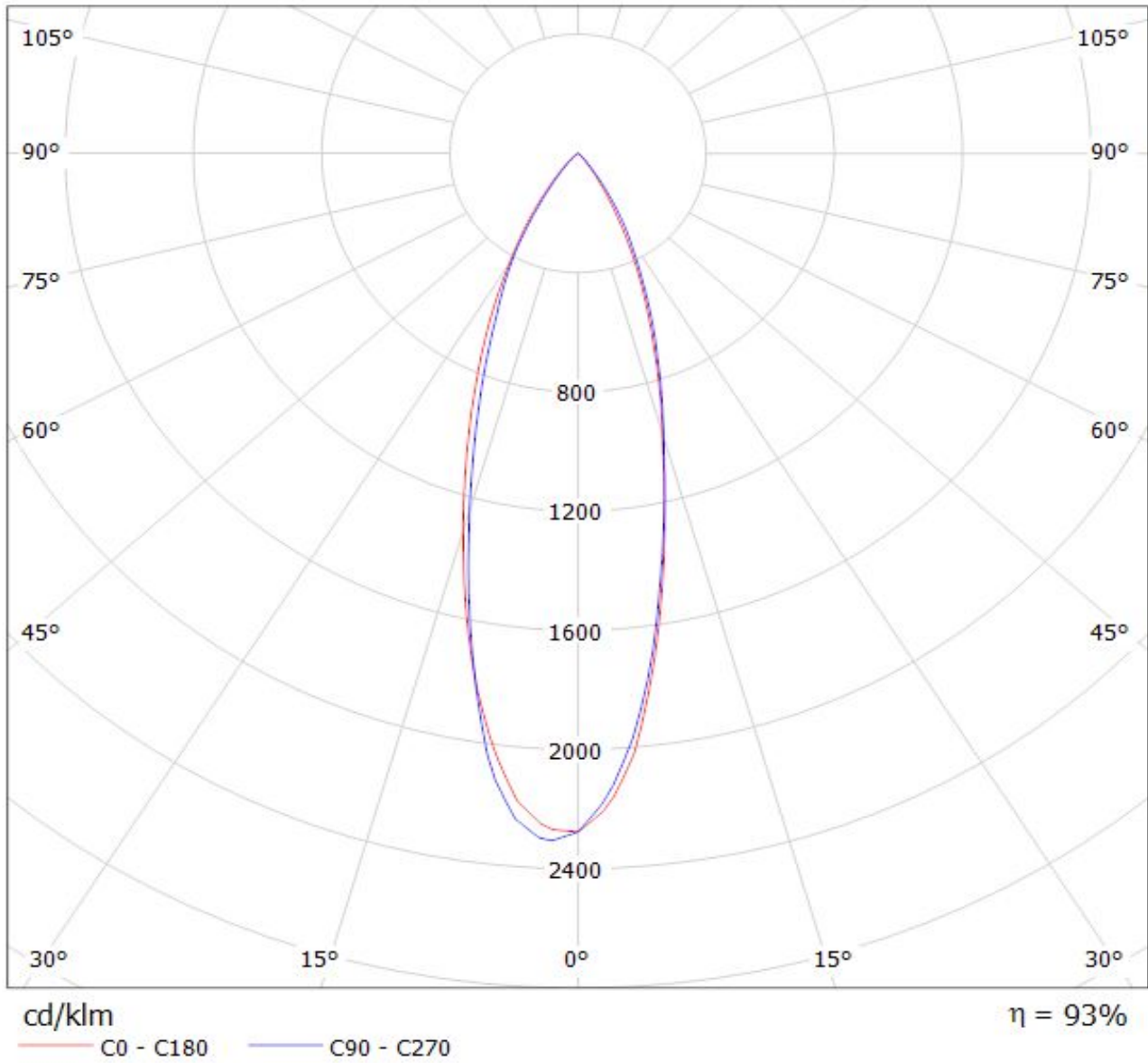

Luminaire: LEDiL C13095_MELODY-3-M_(Luxeon_A) Eff.93%
Lamps: 1 x Luxeon A (193lm@250mA)

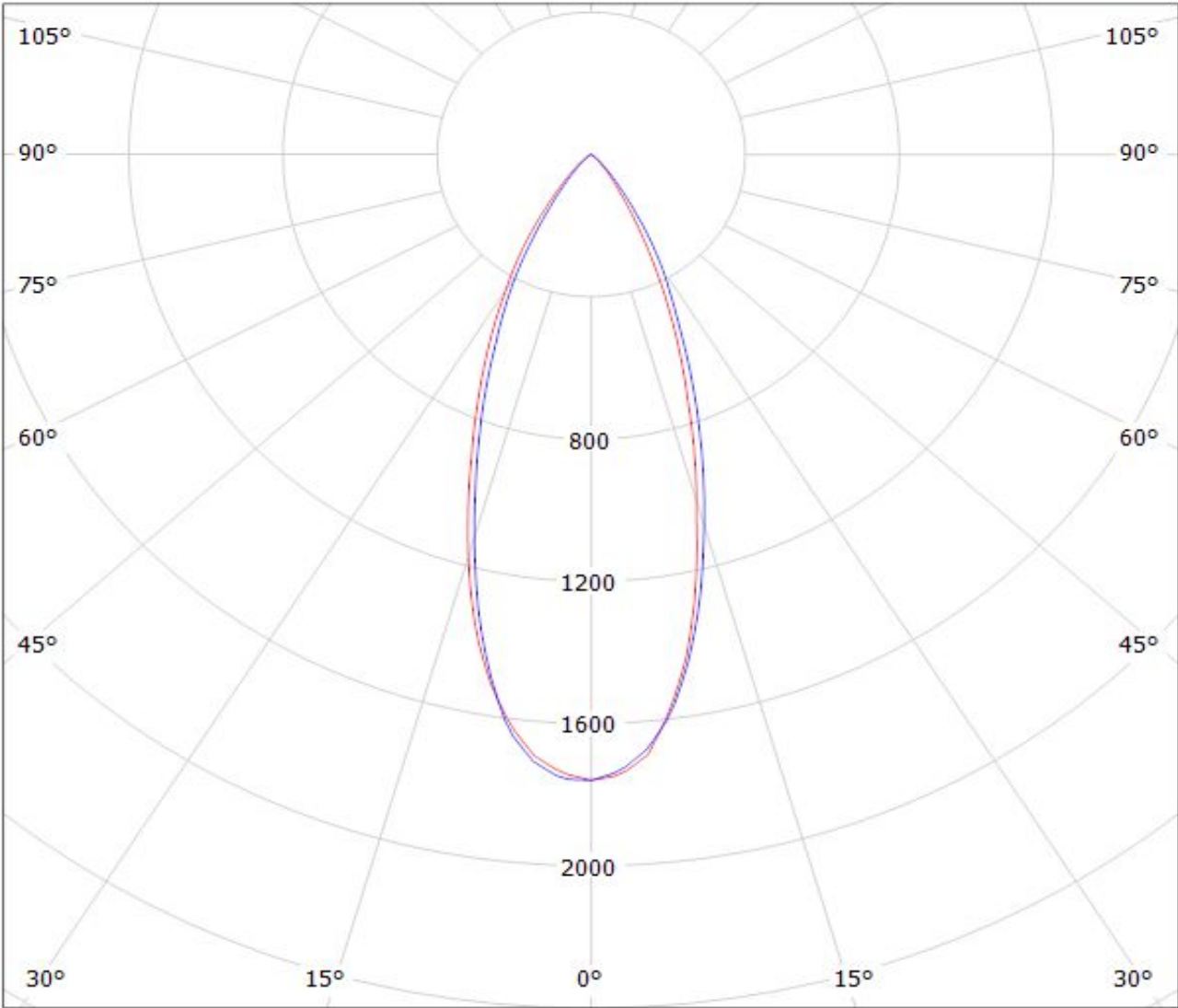

cd/klm

— C0 - C180 — C90 - C270

$\eta = 92\%$

Luminaire: LEDiL C13095_MELODY-3-M_(RE-ES) Eff. 92%
Lamps: 1 x Luxeon Rebel-ES (200lm@250mA)

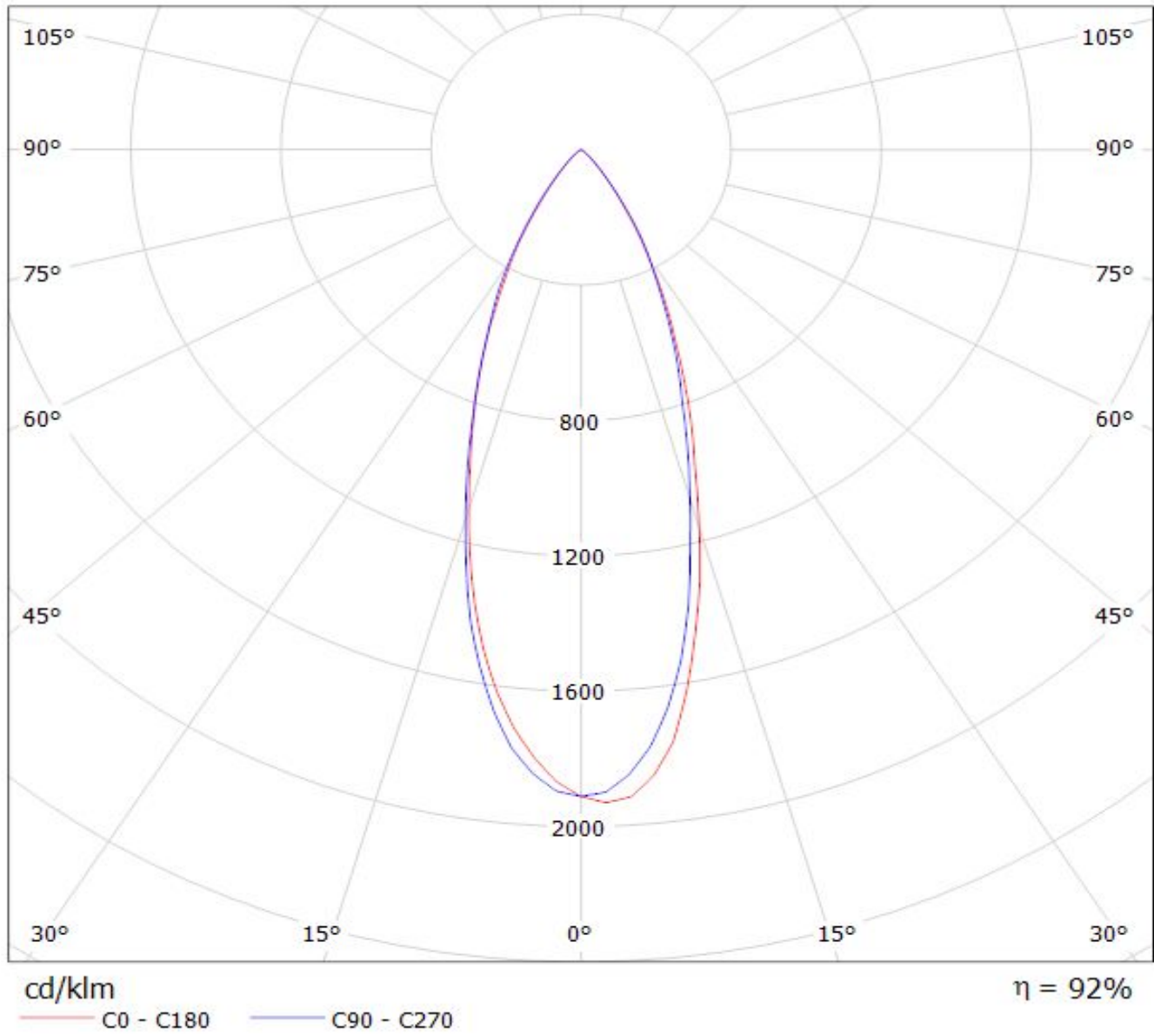

LEDiL Oy C13095_MELODY-3-M_(LUXEON_T) Eff.91.8% / LDC (Polar)

Luminaire: LEDiL Oy C13095_MELODY-3-M_(LUXEON_T) Eff.91.8%

Lamps: 1 x LUXEON_T (220lm@250mA)

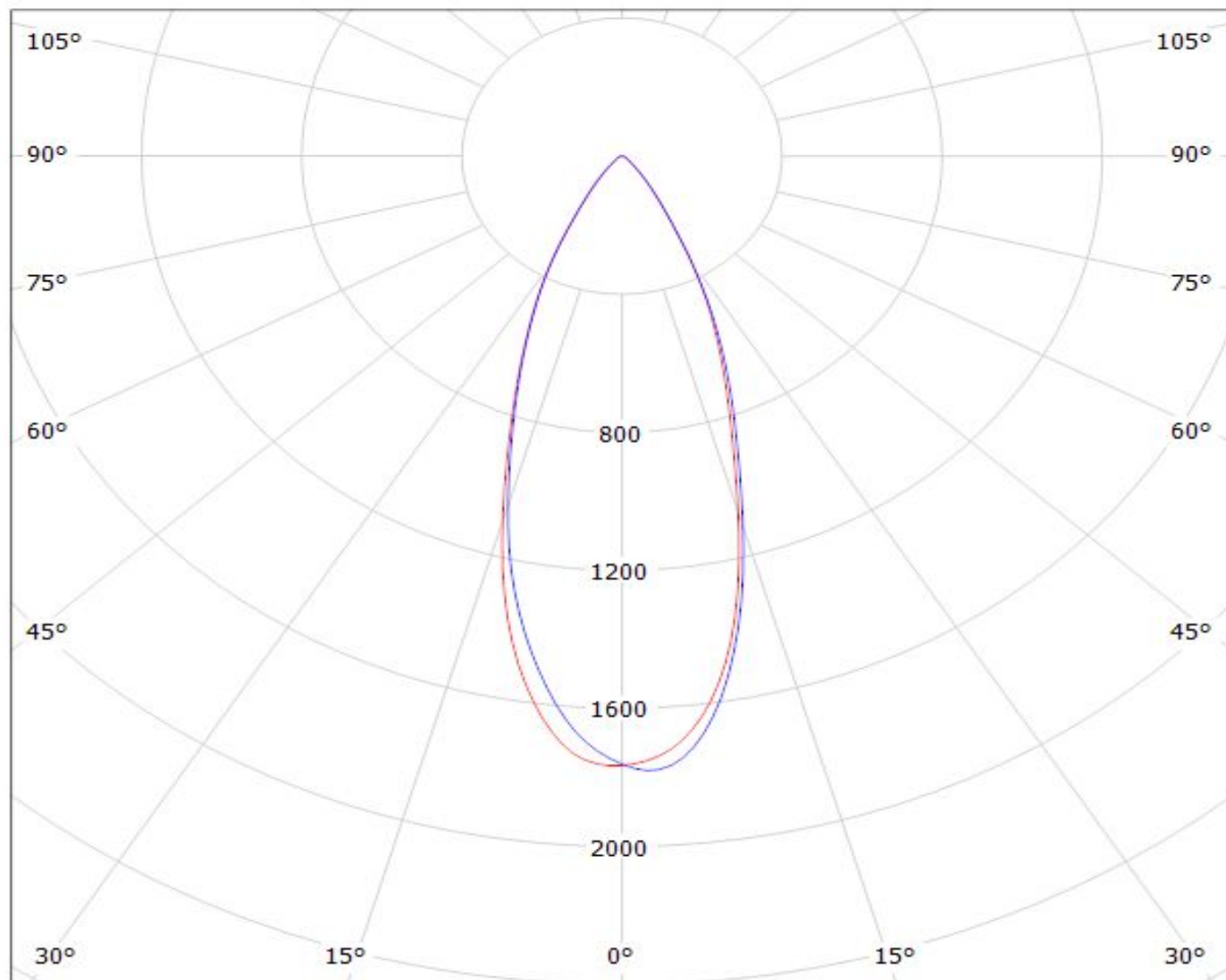

cd/klm

— C0 - C180

— C90 - C270

$\eta = 92\%$

Luminaire: Ledil Oy C13095_MELODY-3-M_(Luxeon_TX) Efficiency=91%
Lamps: 1 x Luxeon TX 236lm @ 250mA CCT= P=2.10 I=250mA

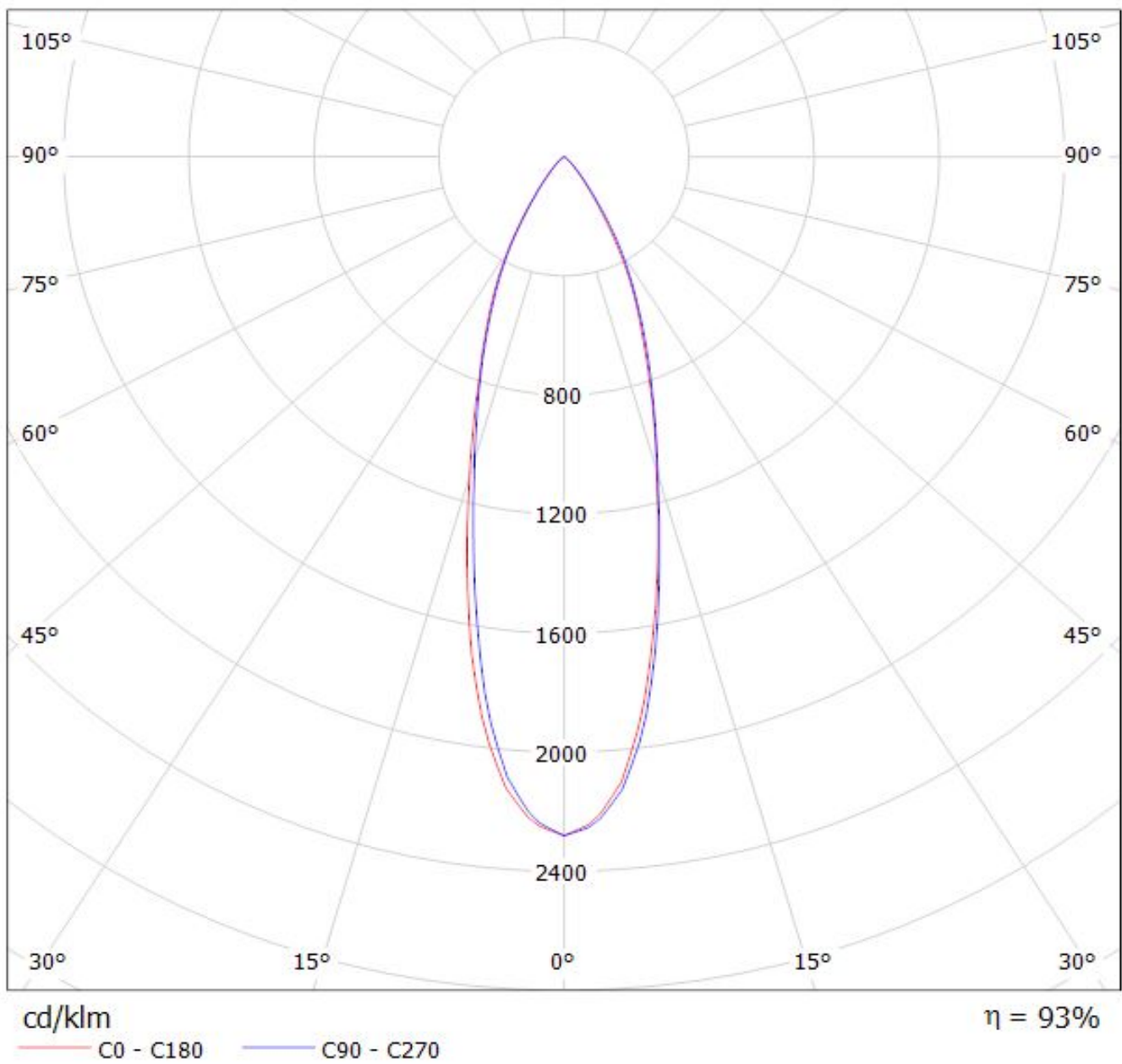

Luminaire: LEDiL C13095_MELODY-3-M_(NCS19) Eff. 92%
Lamps: 1 x Nichia NCS19 (257lm@250mA)

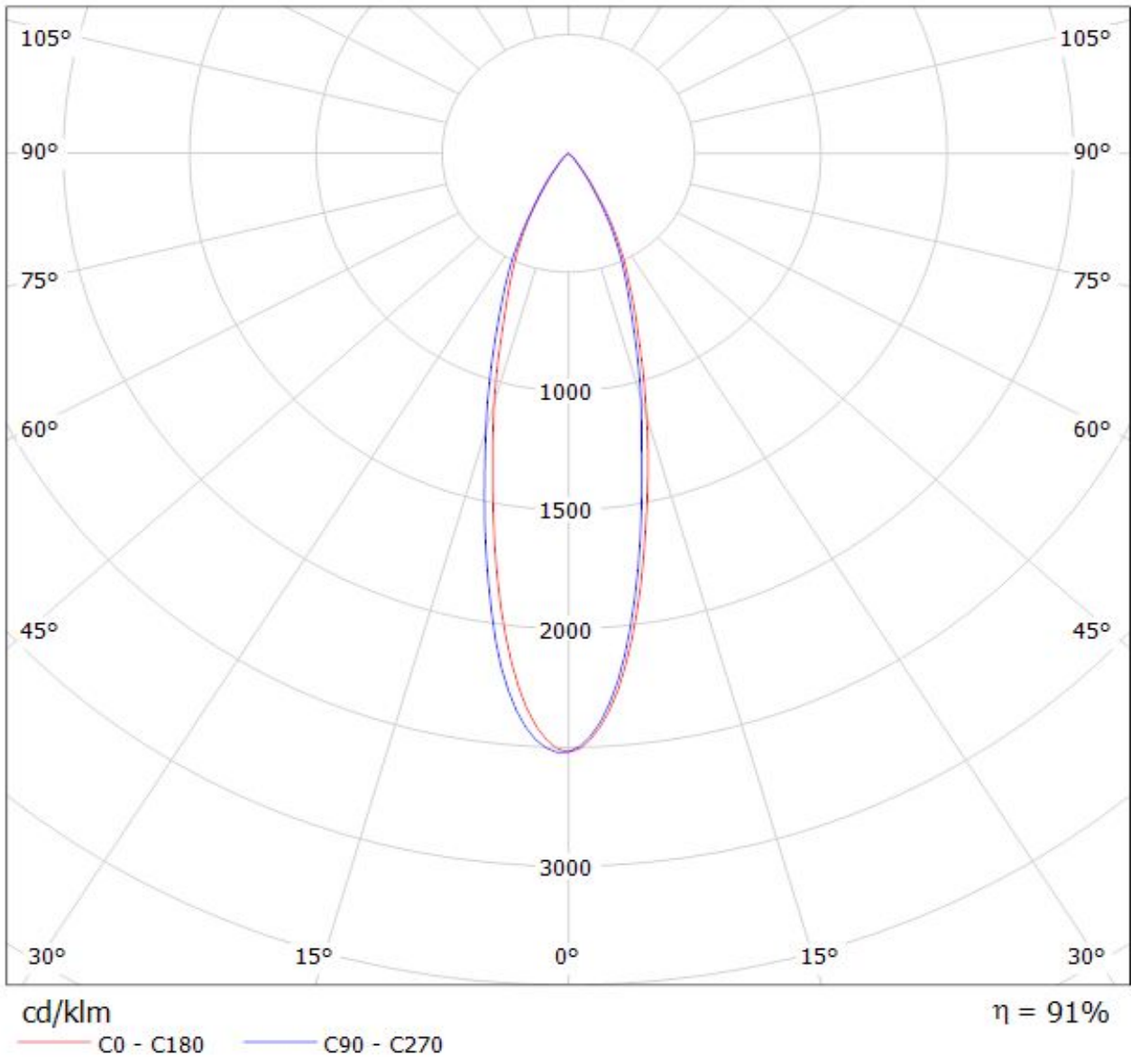

Luminaire: LEDiL C13095_MELODY-3-M
Lamps: 1 x Nichia NVSL219BE (228lm@250mA)

Eff. 92%

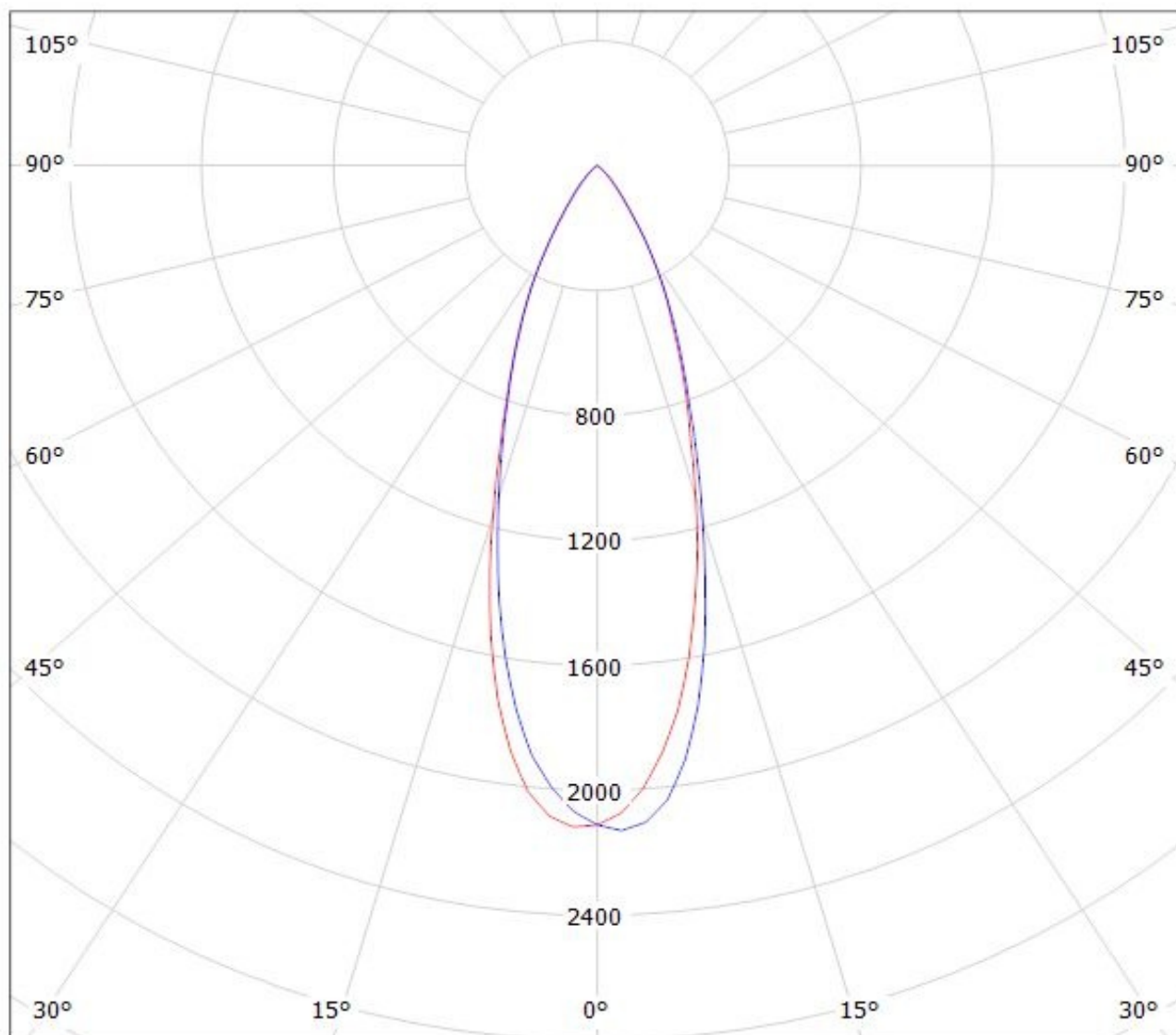

cd/klm

$\eta = 92\%$

— C0 - C180 — C90 - C270

Luminaire: Ledil Oy C13095_MELODY-3-M_(NCSxx19B) Efficiency=91%
Lamps: 1 x Nichia NCSxx19B (NCSL119BE) 272lm @ 250mA CCT=3000K P=2.3W I=250mA

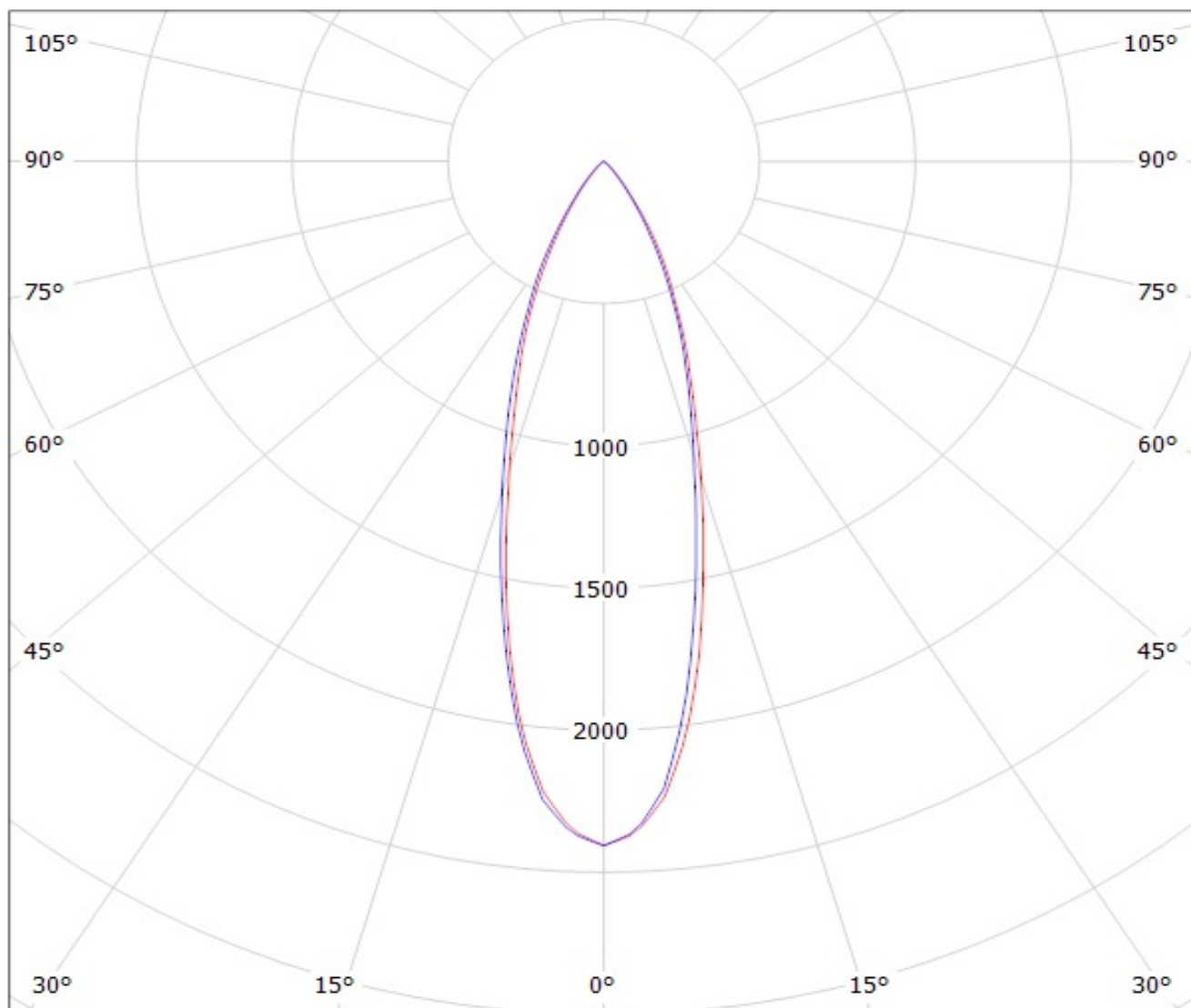

cd/klm

— C0 - C180

— C90 - C270

Luminaire: LEDiL C13095_MELODY-3-M_(SSL80) Eff 92%
Lamps: 1 x Oslon SSL80 (203lm@250mA)

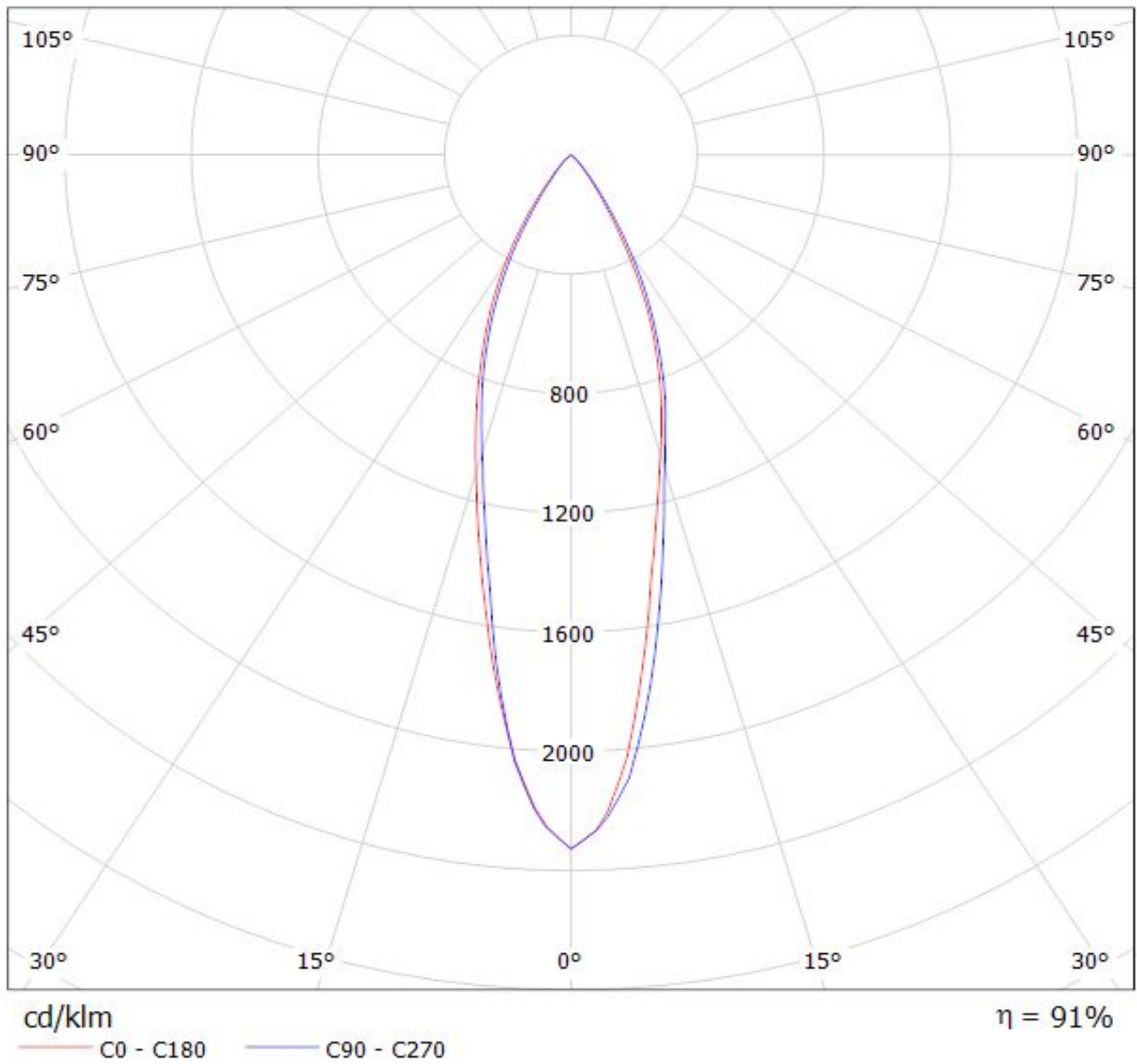

Luminaire: LEDiL C13095_MELODY-3-M_(SSL150) Eff.93%
Lamps: 1 x Oslon SSL150 (326lm@250mA)

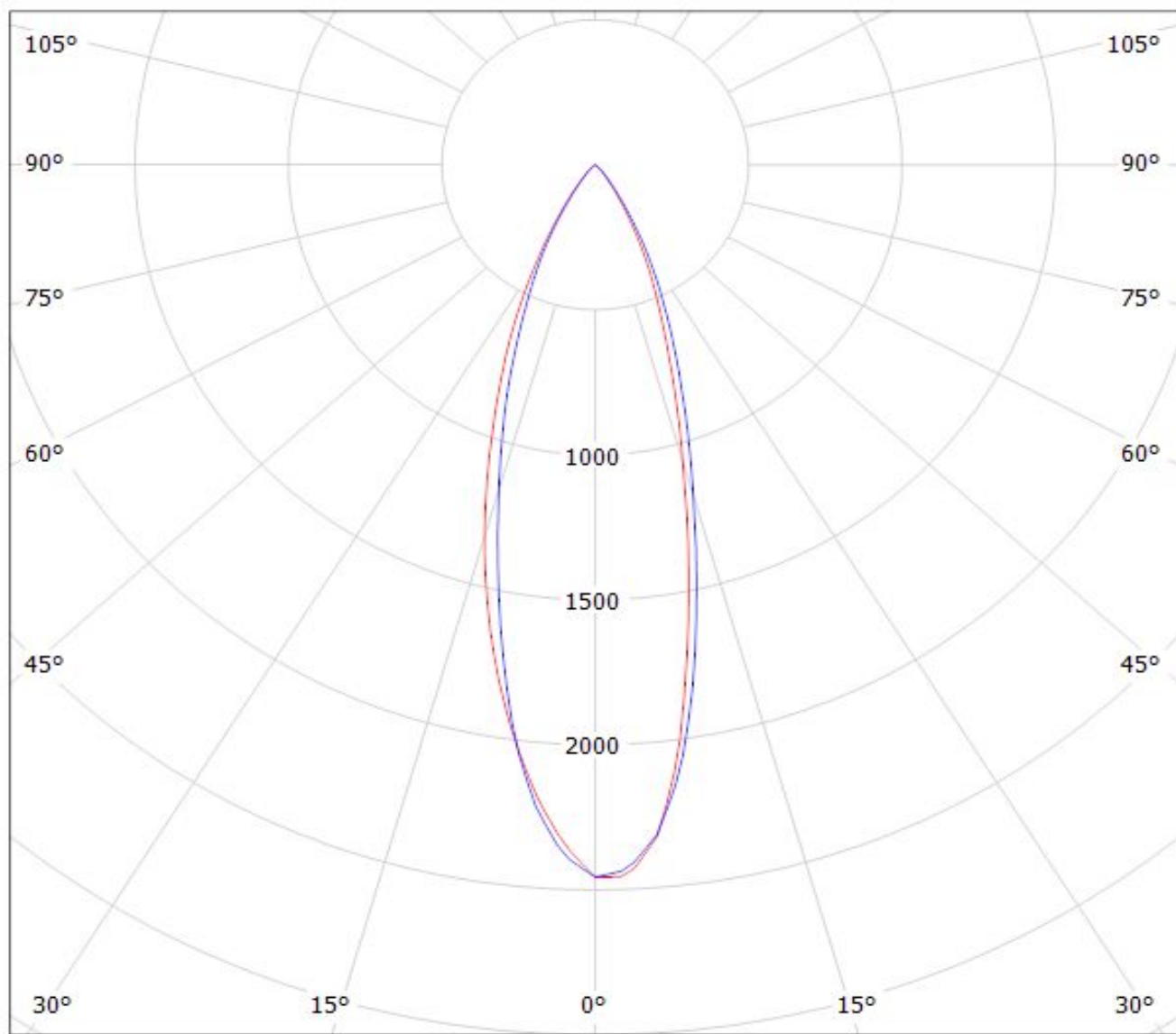

cd/klm
— C0 - C180 — C90 - C270

$\eta = 91\%$

Luminaire: LEDiL C13095_MELODY-3-M_(Square_EC) Eff. 92%
Lamps: 1 x Osram Square EC (277lm@250mA)

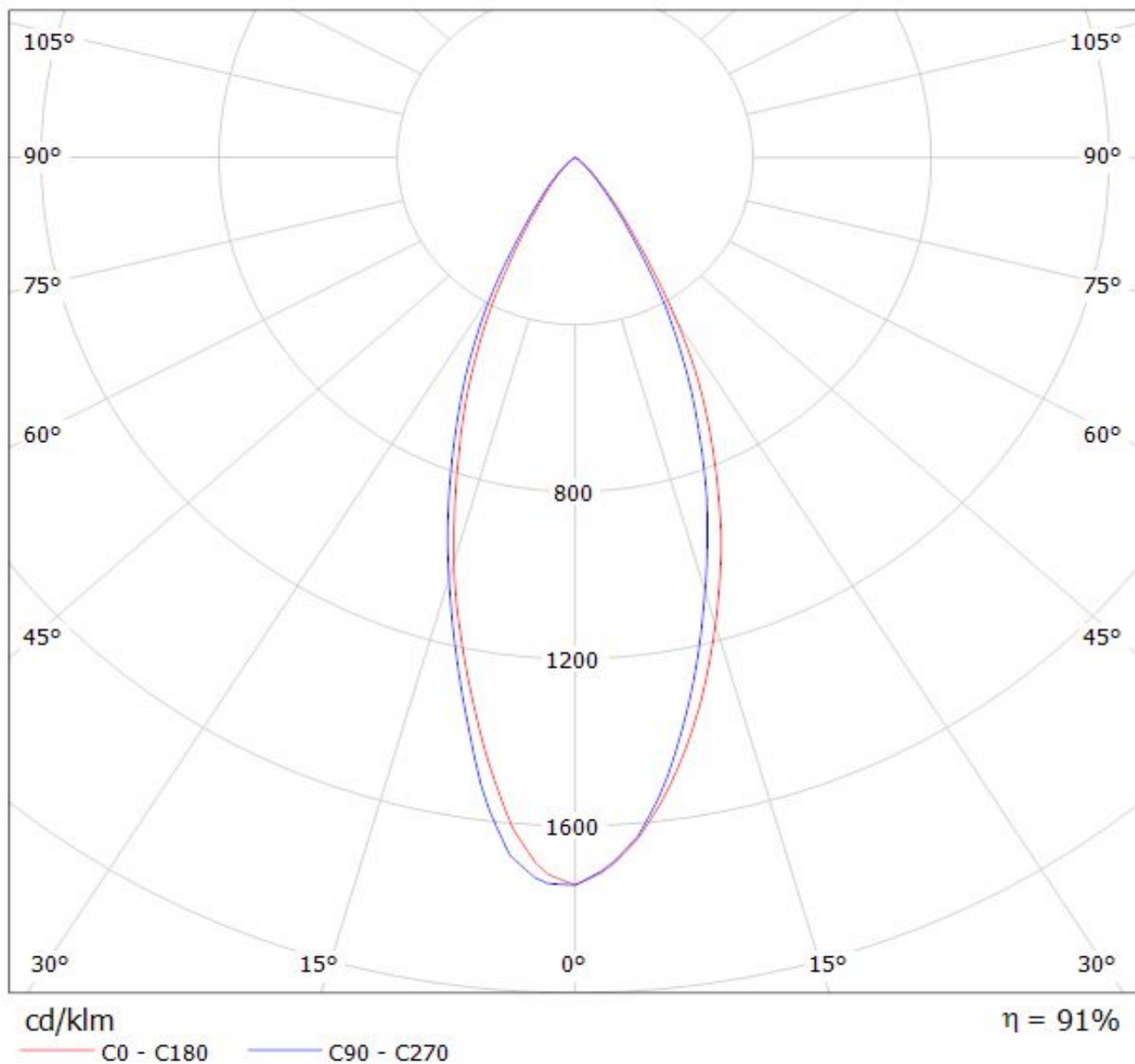

NOTE: The typical divergence will be changed by different color, chip size and chip position tolerance. The typical total divergence is the full angle measured where the luminous intensity is half of the peak value.