

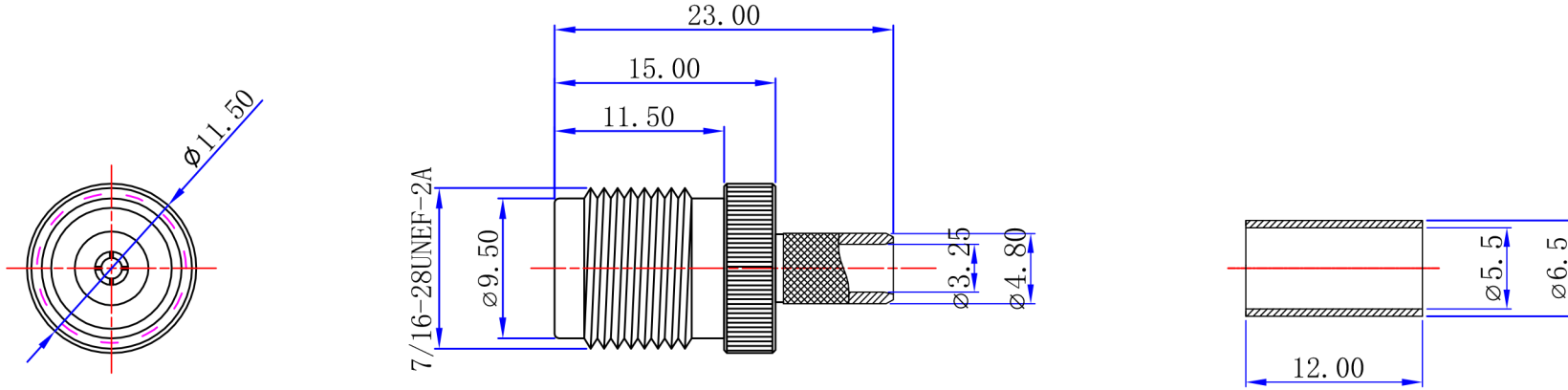

Product NO. BC-102-195

REV	DESCRIPTION	DWN	DATE	APPROVEN
R1.0	First issue	Gavin	2021/03/09	JIM. KING



Specifications:

IMPEDANCE: 50 Ohms
 Frequency range: 0~6GHZ
 VSWR: 1.5MAX
 Working voltage: 500V rms @ sea level
 Insulation resistance: 5000 MOhms min
 Temperature range: -40°C TO +155°C

No	Connector color
BC-102-195-RD	Body electrophoresis: Red
BC-102-195-BL	Body electrophoresis: Blue
BC-102-195-BK	Body electrophoresis: Black

-TOLERANCES-
UNLESS OTHERWISE
SPECIFIED



BIG CAT CABLES

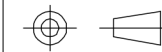

PART DESCRIPTION:
Female TNC JACK FOR LMR195 CABLE

Appd: JIM. KING

P/N: BC-102-195

UNLESS OTHERWISE SPECIFIED
TOLERANCES FOR MILLIMETERS ARE:
 0.5 - 8mm ± 0.20 mm
 8 - 30mm ± 0.25 mm
 30 - 120mm ± 0.30 mm

Check:	Date	Scale	Unit	Type	Page
Draw: Gavin	2021.03.09	Free	MM	Z	1/1

4	Copper pipe	BRASS	NICKEL	1
3	CONTACT PIN	BRASS	GOLD	1
2	INSULATOR	PTFE	NINE	1
1	BOOY	BRASS	Electrophoresis	1
NO	DESCRIPTION	MATERIAL	FINISH	QTY

1

2

3

4

5

6