

# › GN Series

## Classic Solid State Relays

### Panel Mount - AC Output Single Phase

- › Output current of 10, 25, 50, 75, 100 and 125 Amps
- › Output voltage of 24-280 V $\sim$  and 48-660 V $\sim$
- › Control voltage of 4-32 V $\text{---}$ , 18-36 V $\sim$ , 20-265 V $\sim$  and 90-260 V $\sim$
- › Zero cross or instantaneous (resistive or inductive loads)
- › Integrated IP20 touch-safe removable covers
- › Built-in overvoltage protection (only Zero Cross)
- › LED input status indicator



Zero Cross  
Version



Instantaneous  
Version

Product Selection - Zero Cross (Resistive Loads)							
Rated Load Current	10A	25A		50A	75A	100A	125A
Output Voltage	24-280 V $\sim$	24-280 V $\sim$	48-660 V $\sim$	48-660 V $\sim$	48-660 V $\sim$	48-660 V $\sim$	48-660 V $\sim$
Control Voltage							
4-32 V $\text{---}$	84137000N	84137010N	84137110N	84137120N	84137130N	84137140N	84137180N
18-36 V $\sim$		84137012N		84137122N			
20-265 V $\sim$	84137001N	84137011N	84137111N	84137121N	84137131N	84137141N	84137181N

Product Selection- Instantaneous (Inductive Loads)			
Rated Load Current	25A	50A	75A
Output Voltage	24-280 V $\sim$	48-660 V $\sim$	48-660 V $\sim$
Control Voltage			
4-32 V $\text{---}$	84137210N	84137320N	84137330N
90-260 V $\sim$	84137211N	84137321N	

## PART NUMBERING SYSTEM

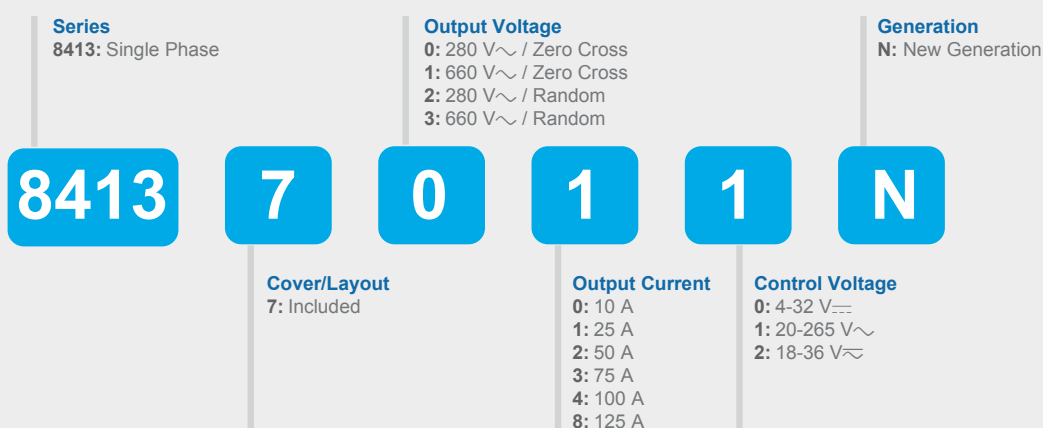

Do you need an adapted or customized solution? Contact us on [www.crouzet.com](http://www.crouzet.com)

#### Description:

Crouzet Solid State Relays are designed to be used in almost any application, offering very long life expectancy and are easy to install, easy to use, robust and multipurpose.

For more information about Crouzet's Solid State relays, please visit [www.crouzet.com](http://www.crouzet.com).

Accessories		
Type	Description	Part-Number
Heatsink	0.9 °C/W Thermal Resistance	26532752N
Heatsink	1.1 °C/W Thermal Resistance	26532753N
Heatsink	1.2 °C/W Thermal Resistance	26532754N
Heatsink	1.75 °C/W Thermal Resistance	26532755N
Heatsink	2.2 °C/W Thermal Resistance	26532756N
Adapter	DIN Rail	26532764N
Thermal Pad	Pre-cut Thermal Pad	26532720N
Thermal Pad	Self-Adhesive Thermal Pad	26532722N
Screws	Screw Mounting Kit	26532001
Thermal Grease	Thermal Grease for Heatsink mounting	26532003

Output Specifications <sup>(1)</sup>							
Description	10A	25A	50A	75A	100A	125A	
Maximum Load Current [Arms] <sup>(3)</sup>	10	25	50	75	100	125	
Minimum Load Current [mArms]	5						
Min / Max Operating Voltage (47-63Hz) [Vrms]	24-280 V $\sim$		48-660 V $\sim$				
Transient Voltage [Vpeak] <sup>(2)</sup> (Random version)	600 (600)		1200 (1600)				
Maximum Off-State Leakage Current @ Rated Voltage [mArms] (Random version)	1 (5)						
Minimum Off-State dV/dt @ Maximum Rated Voltage [V/ $\mu$ sec]	500						
1 Second Surge Current (Apk. Ta=25 °C) 50/60 Hz	45	100	125	230	347	613	
Maximum 1 Cycle Surge Current (50/60 Hz) [Apeak] Typ @ 50 Hz	120/126 (min) 160 (typ)	270/284 (min) 340 (typ)	280/_ (min) 500 (typ)	700/_ (min) 750 (typ)	1100/_ (min) 1200 (typ)	2000/_ (min) 2100 (typ)	
Maximum On-State Voltage Drop @ Rated Current [Vpeak] (Random version)	1.2	1.23 (1.08)	1.25 (1.37)	1.38 (1.37)	1.34 (1.34)	1.45	1.15
Thermal Resistance Junction to Case (Rjc) [°C/W] (Random version)	2.3	1.7 (0.7)	0.55 (0.7)	0.4 (0.4)	0.3 (0.3)		0.25
Maximum 1/2 Cycle I <sup>2</sup> t for Fusing @ 50 Hz (min. / typical) [A <sup>2</sup> sec] (Random version)	78/128	487/600 (512/882)	720/1250 (512/882)	2450/2800 (2450/2500)	6000/7200 (6000/7200)	6000/7200	20000/22000
Minimum Heat Sink for Rated Current @ 40 °C [°C/W] (Random version)	5.3	1.3 (2.6)	2.08 (2.6)	0.84 (0.84)	0.52 (0.52)	0.23	0.29

Input Specifications				
Description	4-32 V $\equiv$	18-36 V $\approx$	20-265 V $\sim$	90-260 V $\sim$
Input Voltage Range	4-32 V $\equiv$ <sup>(4)</sup>	18-36 V $\approx$	20-265 V $\sim$	90-260 V $\sim$
Maximum Reverse Voltage	-32 V $\equiv$	N/A		
Minimum Turn-On Voltage	3 V $\equiv$	18 V $\approx$		90 V $\sim$
Must Turn-Off Voltage	1 V $\equiv$	5 V $\approx$		5 V $\sim$
Minimum Input Current (for on-state)	10 mA	5 mA AC / 4 mA DC		6.5 mA
Maximum Input Current [mA]	14 mA	10 mA		
Nominal Input Impedance [Ohms]	Current Limited			
Maximum Turn-On Time [msec]	1/2 Cycle <sup>(5)</sup>		< 0.1	
Maximum Turn-Off Time [msec]	1/2 Cycle <sup>(5)</sup>			

General Specifications						
Description	10A	25A	50A	75A	100A	125A
Dielectric Strength, Input to Output (50/60 Hz)	4000 Vrms					
Dielectric Strength, Input/Output to Ground (50/60 Hz)	2500 Vrms		4000 Vrms			
Minimum Insulation Resistance (@ 500 V <sub>DC</sub> )	10 <sup>9</sup> Ω					
Maximum Capacitance, Input/Output	0.8 pF					
Ambient Operating Temperature Range	-40 to 80 °C					
Ambient Storage Temperature Range	-40 to 100 °C					
Weight (typical)	80 g					
Housing Material	UL94 V-0					
Baseplate Material	Aluminum					
Input Terminal Screw Torque Range (in-lb/Nm)	11-18 /1.2-2.0					
Load Terminal Screw Torque Range (in-lb/Nm)	18-26 / 2-3					
SSR Mounting Screw Torque Range (in-lb/Nm)	11-16 /1.2-1.8					
Humidity per IEC60068-2-78	40-85 %					
LED Input Status Indicator	Green					
MTBF (Mean Time Between Failures) at 40 °C ambient temperature <sup>(5)</sup> (years)	72					
MTBF (Mean Time Between Failures) at 60 °C ambient temperature <sup>(5)</sup> (years)	46					

General Notes
<sup>(1)</sup> All parameters at 25 °C unless otherwise specified
<sup>(2)</sup> Output will self trigger between 450-600 Vpk not suitable for capacitive loads
<sup>(3)</sup> Heat sinking required, see derating curves
<sup>(4)</sup> Increase minimum voltage by 1 V for operations from -20 to -40 °C
<sup>(5)</sup> All parameters at 50 % power rating and 100 % duty cycle (contact tech support for detailed report)

**Diagrams**  
**Wiring**

GN Recommended Wire Size

TERMINALS	WIRE SIZE		Terminal Screw Torque (N.m)
	SOLID	STRANDED	
<b>Input</b>	18..14 AWG (0.75..2.5 mm <sup>2</sup> ) 2 x 18..14 AWG (0.75..2.5 mm <sup>2</sup> )	18..14 AWG (0.75..2.5 mm <sup>2</sup> ) 2 x 18..14 AWG (0.75..2.5 mm <sup>2</sup> )	1.2 - 2
<b>Output</b>	16..8 AWG (1.5..10 mm <sup>2</sup> ) 2 x 16..8 AWG (1.5..10 mm <sup>2</sup> )	16..8 AWG (1.5..6 mm <sup>2</sup> ) 2 x 16..10 AWG (1.5..6 mm <sup>2</sup> )	2 - 3

For the random (instantaneous) models, external overvoltage protection is recommended: TVS Diode

1 Load

Diagrams

Equivalent Circuit Block

GN Series 4-32 V $\overline{\text{---}}$  control (Thyristors) - All out 660 V $\sim$

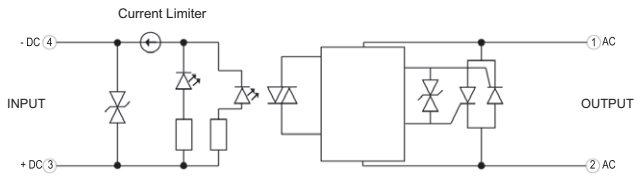

Input current vs Input Voltage  
Standard Regulated DC inputs

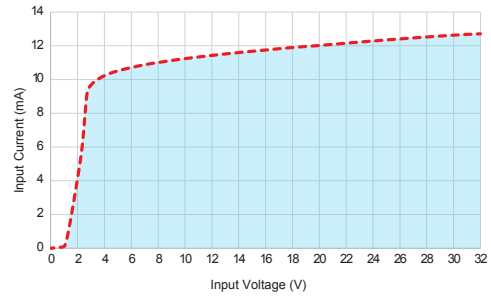

GN Series 4-32 V $\overline{\text{---}}$  control (Triac) - 10 A /25 A (280 V $\sim$ )

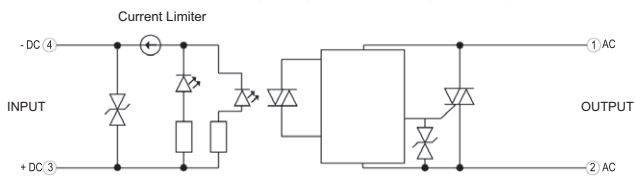

Input current vs Input Voltage  
Standard Regulated DC inputs

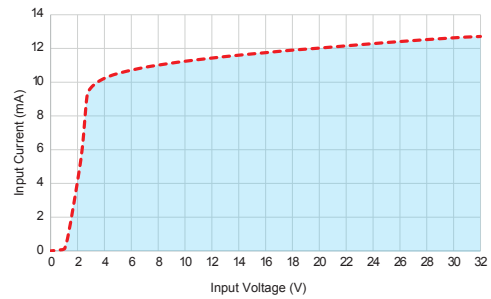

GN Series 18-36 V $\sim$  control

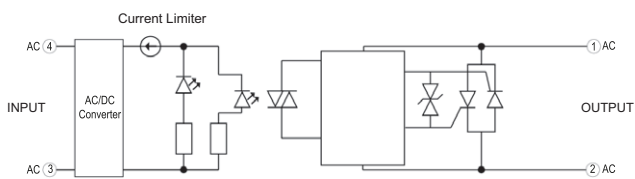

Input current vs Input Voltage  
Standard Regulated AC/DC inputs

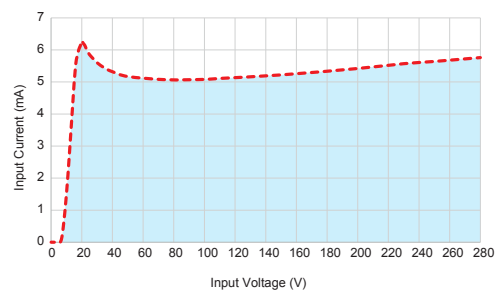

GN Series 20-265 V $\sim$  control

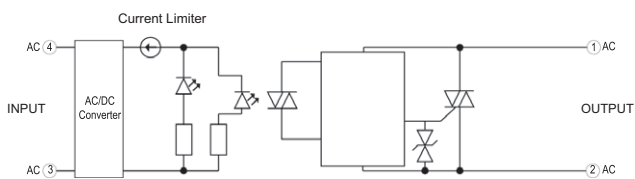

Input current vs Input Voltage  
Standard Regulated AC inputs

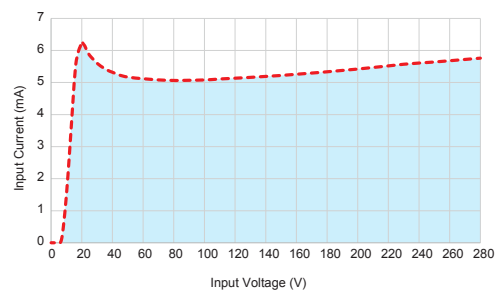

GN Series 4-32 V<sub>DC</sub> control instantaneous

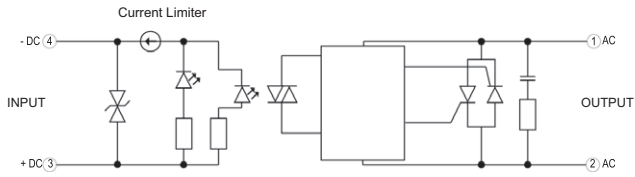

Input current vs Input Voltage  
Standard Regulated DC inputs

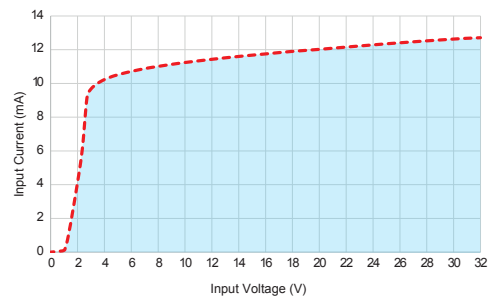

GN Series 90-260 V<sub>AC</sub> control instantaneous

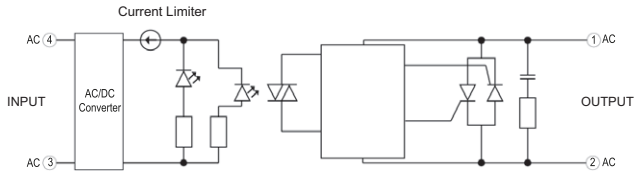

Input current vs Input Voltage  
Standard Regulated AC inputs

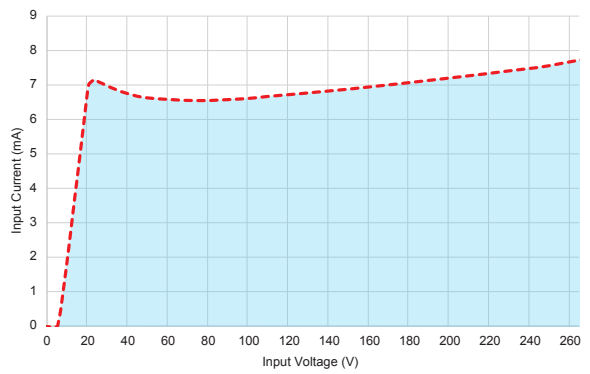

Diagrams

Dimensions (mm)

GN front view

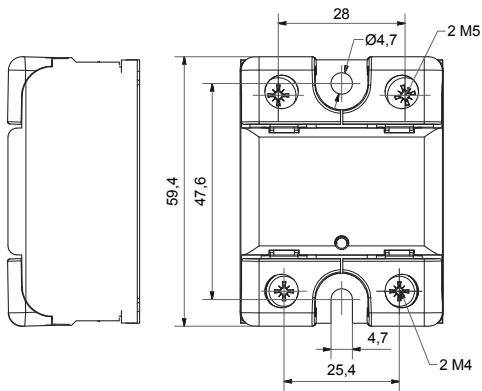

GN side view

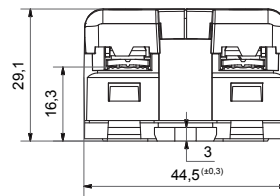

Curves

Surge Current Information

GN - 10 A

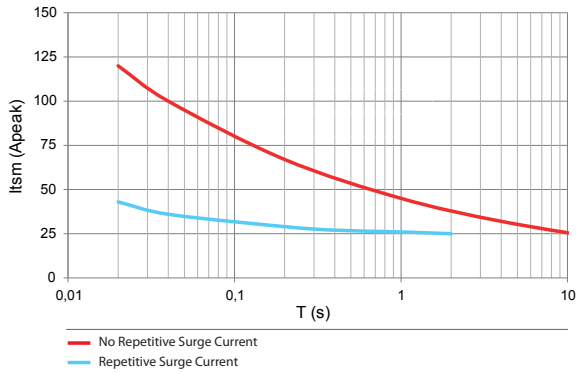

GN - 25 A

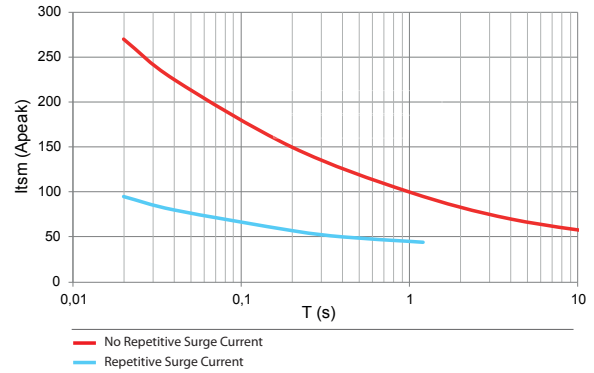

GN - 50 A

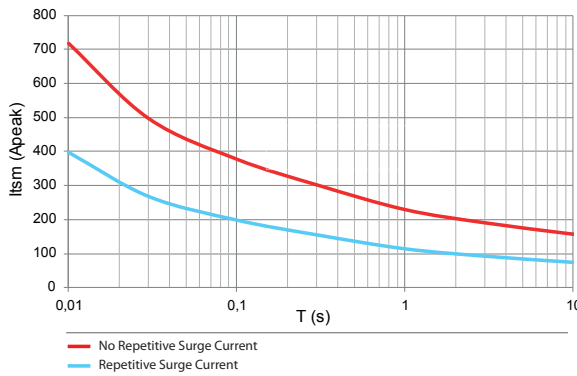

GN - 75 A

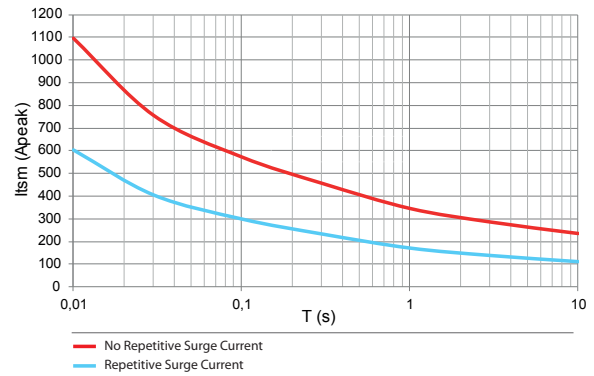

GN - 100 A

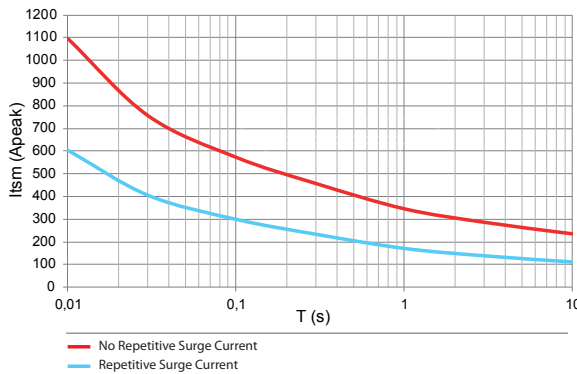

GN - 125 A

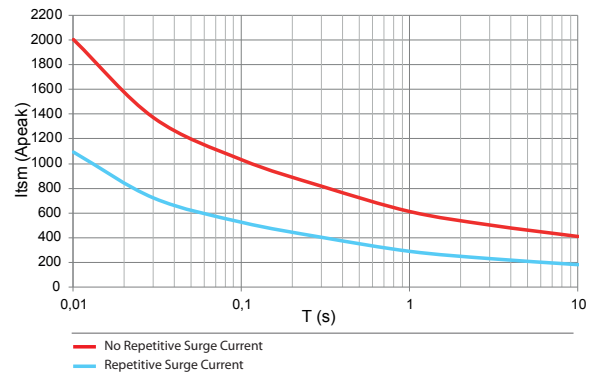

GN - 25 A Instantaneous

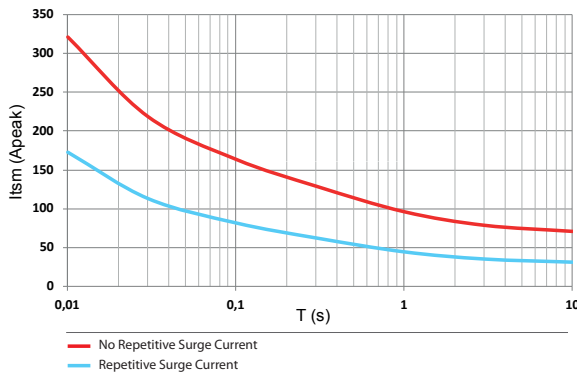

GN - 50 A Instantaneous

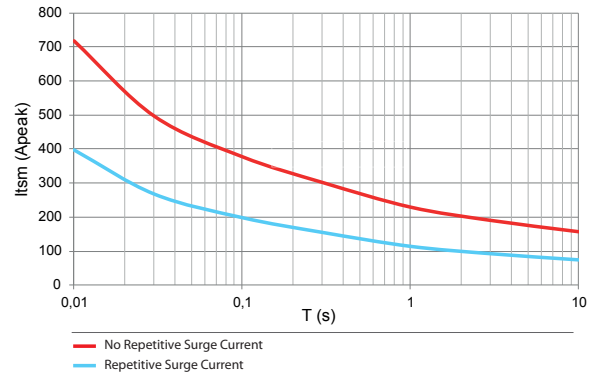

GN - 75 A Instantaneous

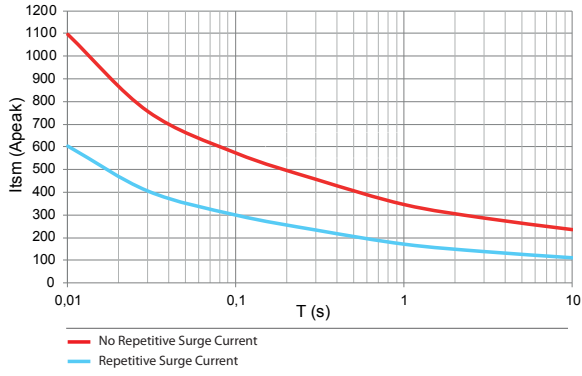

Curves

Thermal Derating Curves

GN - 10 A

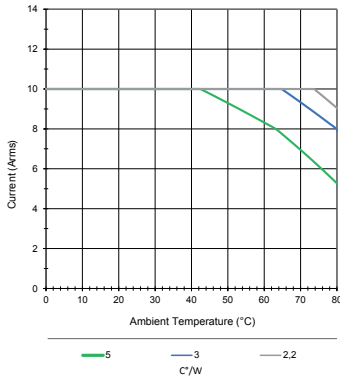

GN - 25 A

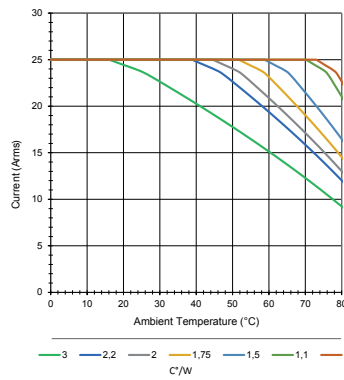

GN - 50 A

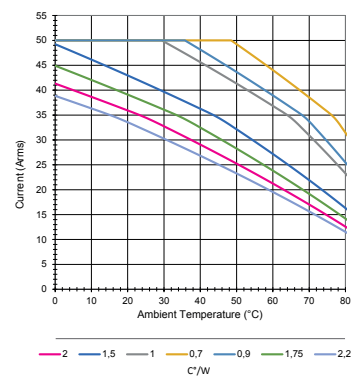

GN - 75 A

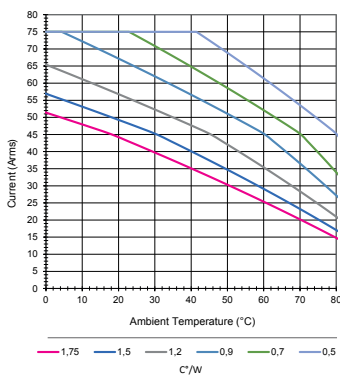

GN - 100 A

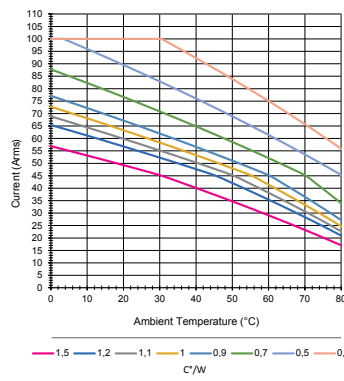

GN - 125 A

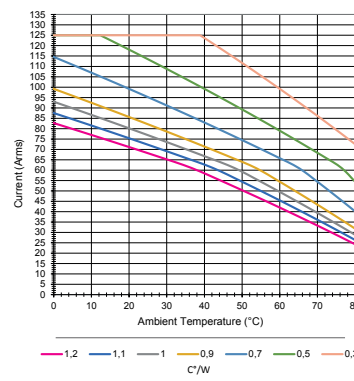

GN - 25 A Instantaneous

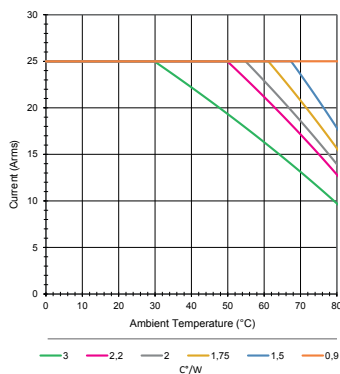

GN - 50 A Instantaneous

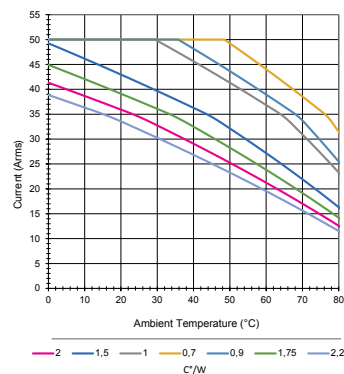

GN - 75 A Instantaneous

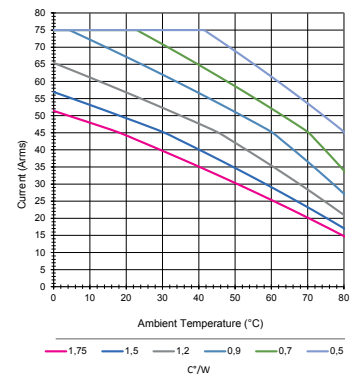

**Standards Specifications**ZERO CROSS

IEC/EN61000-4-4 (bursts)	2 kv crit B
IEC/EN61000-4-5 (surge)	2 kv crit B
VIBRATION resistance IEC 60068-2-6	10 g
SHOCK resistance IEC 60068-2-27	50 G (11 ms)

RANDOM

IEC/EN61000-4-4 (bursts)	4 kv crit A
IEC/EN61000-4-5 (surge)	4 kv crit A
VIBRATION resistance IEC 60068-2-6	10 g
SHOCK resistance IEC 60068-2-27	50 G (11 ms)



\* VDE ONLY 84137000N / 84137110N / 84137120N / 84137130N / 84137140N / 84137180N / 84137210N / 84137211N / 84137320N / 84137321N / 84137330N

**Warning:**

The product information contained in this catalogue is given purely as information and does not constitute a representation, warranty or any form of contractual commitment. Crouzet and its subsidiaries reserve the right to modify their products without notice. It is imperative that we should be consulted over any particular use or application of our products and it is the responsibility of the buyer to establish, particularly through all the appropriate tests, that the product is suitable for the use or application. Under no circumstances will our warranty apply, nor shall we be held responsible for any application (such as any modification, addition, deletion, use in conjunction with other electrical or electronic components, circuits or assemblies, or any other unsuitable material or substance) which has not been expressly agreed by us prior to the sale of our products.