



MICROCHIP

**RN2903 LoRa™ Technology
PICtail™/PICtail Plus
Daughter Board
User's Guide**

Note the following details of the code protection feature on Microchip devices:

- Microchip products meet the specification contained in their particular Microchip Data Sheet.
- Microchip believes that its family of products is one of the most secure families of its kind on the market today, when used in the intended manner and under normal conditions.
- There are dishonest and possibly illegal methods used to breach the code protection feature. All of these methods, to our knowledge, require using the Microchip products in a manner outside the operating specifications contained in Microchip's Data Sheets. Most likely, the person doing so is engaged in theft of intellectual property.
- Microchip is willing to work with the customer who is concerned about the integrity of their code.
- Neither Microchip nor any other semiconductor manufacturer can guarantee the security of their code. Code protection does not mean that we are guaranteeing the product as "unbreakable."

Code protection is constantly evolving. We at Microchip are committed to continuously improving the code protection features of our products. Attempts to break Microchip's code protection feature may be a violation of the Digital Millennium Copyright Act. If such acts allow unauthorized access to your software or other copyrighted work, you may have a right to sue for relief under that Act.

Information contained in this publication regarding device applications and the like is provided only for your convenience and may be superseded by updates. It is your responsibility to ensure that your application meets with your specifications. MICROCHIP MAKES NO REPRESENTATIONS OR WARRANTIES OF ANY KIND WHETHER EXPRESS OR IMPLIED, WRITTEN OR ORAL, STATUTORY OR OTHERWISE, RELATED TO THE INFORMATION, INCLUDING BUT NOT LIMITED TO ITS CONDITION, QUALITY, PERFORMANCE, MERCHANTABILITY OR FITNESS FOR PURPOSE. Microchip disclaims all liability arising from this information and its use. Use of Microchip devices in life support and/or safety applications is entirely at the buyer's risk, and the buyer agrees to defend, indemnify and hold harmless Microchip from any and all damages, claims, suits, or expenses resulting from such use. No licenses are conveyed, implicitly or otherwise, under any Microchip intellectual property rights unless otherwise stated.

Trademarks

The Microchip name and logo, the Microchip logo, dsPIC, FlashFlex, flexPWR, JukeBlox, KEELOQ, KEELOQ logo, Klear, LANCheck, MediaLB, MOST, MOST logo, MPLAB, OptoLyzer, PIC, PICSTART, PIC³² logo, RightTouch, SpyNIC, SST, SST Logo, SuperFlash and UNI/O are registered trademarks of Microchip Technology Incorporated in the U.S.A. and other countries.

The Embedded Control Solutions Company and mTouch are registered trademarks of Microchip Technology Incorporated in the U.S.A.

Analog-for-the-Digital Age, BodyCom, chipKIT, chipKIT logo, CodeGuard, dsPICDEM, dsPICDEM.net, ECAN, In-Circuit Serial Programming, ICSP, Inter-Chip Connectivity, KlearNet, KlearNet logo, MiWi, motorBench, MPASM, MPF, MPLAB Certified logo, MPLIB, MPLINK, MultiTRAK, NetDetach, Omniscient Code Generation, PICDEM, PICDEM.net, PICkit, PICtail, RightTouch logo, REAL ICE, SQI, Serial Quad I/O, Total Endurance, TSHARC, USBCheck, VariSense, ViewSpan, WiperLock, Wireless DNA, and ZENA are trademarks of Microchip Technology Incorporated in the U.S.A. and other countries.

SQTP is a service mark of Microchip Technology Incorporated in the U.S.A.

Silicon Storage Technology is a registered trademark of Microchip Technology Inc. in other countries.

GestIC is a registered trademark of Microchip Technology Germany II GmbH & Co. KG, a subsidiary of Microchip Technology Inc., in other countries.

All other trademarks mentioned herein are property of their respective companies.

© 2015, Microchip Technology Incorporated, Printed in the U.S.A., All Rights Reserved.

ISBN: 978-1-63277-885-7

**QUALITY MANAGEMENT SYSTEM
CERTIFIED BY DNV
= ISO/TS 16949 =**

Microchip received ISO/TS-16949:2009 certification for its worldwide headquarters, design and wafer fabrication facilities in Chandler and Tempe, Arizona; Gresham, Oregon and design centers in California and India. The Company's quality system processes and procedures are for its PIC[®] MCUs and dsPIC[®] DSCs, KEELOQ[®] code hopping devices, Serial EEPROMs, microperipherals, nonvolatile memory and analog products. In addition, Microchip's quality system for the design and manufacture of development systems is ISO 9001:2000 certified.

Object of Declaration: RN2903 LoRa™ Technology PICtail™/PICtail Plus Daughter Board

EU Declaration of Conformity

Manufacturer: Microchip Technology Inc.
2355 W. Chandler Blvd.
Chandler, Arizona, 85224-6199
USA

This declaration of conformity is issued by the manufacturer.

The development/evaluation tool is designed to be used for research and development in a laboratory environment. This development/evaluation tool is not a Finished Appliance, nor is it intended for incorporation into Finished Appliances that are made commercially available as single functional units to end users under EU EMC Directive 2004/108/EC and as supported by the European Commission's Guide for the EMC Directive 2004/108/EC (8th February 2010).

This development/evaluation tool complies with EU RoHS2 Directive 2011/65/EU.

This development/evaluation tool, when incorporating wireless and radio-telecom functionality, is in compliance with the essential requirement and other relevant provisions of the R&TTE Directive 1999/5/EC and the FCC rules as stated in the declaration of conformity provided in the module datasheet and the module product page available at www.microchip.com.

For information regarding the exclusive, limited warranties applicable to Microchip products, please see Microchip's standard terms and conditions of sale, which are printed on our sales documentation and available at www.microchip.com.

Signed for and on behalf of Microchip Technology Inc. at Chandler, Arizona, USA

Derek Carlson
VP Development Tools

12-Sep-14
Date

NOTES:



RN2903 LoRa™ TECHNOLOGY PICtail™/PICtail PLUS DAUGHTER BOARD USER'S GUIDE

Table of Contents

Preface	7
Chapter 1. Overview	
1.1 Introduction	11
1.2 Features	11
1.3 Contents	13
1.4 Board Configuration	13
Chapter 2. Getting Started	
2.1 Introduction	15
2.2 Communication Modes	15
2.3 Communication to the Module	16
2.4 Hardware Description	16
Appendix A. Board Schematic and PCB Details	
A.1 Introduction	19
A.2 Board Schematic	19
A.3 PCB Layout	21
A.4 Bill of Materials	24
Worldwide Sales and Service	25

NOTES:



RN2903 LoRa™ TECHNOLOGY PICtail™/PICtail PLUS DAUGHTER BOARD USER'S GUIDE

Preface

NOTICE TO CUSTOMERS

All documentation becomes dated, and this manual is no exception. Microchip tools and documentation are constantly evolving to meet customer needs, so some actual dialogs and/or tool descriptions may differ from those in this document. Please refer to our web site (www.microchip.com) to obtain the latest documentation available.

Documents are identified with a “DS” number. This number is located on the bottom of each page, in front of the page number. The numbering convention for the DS number is “DSXXXXXXXXA”, where “XXXXXXXX” is the document number and “A” is the revision level of the document.

For the most up-to-date information on development tools, see the MPLAB® IDE online help. Select the Help menu, and then Topics to open a list of available online help files.

INTRODUCTION

This chapter contains general information that will be useful to know before using the RN2903 LoRa™ Technology PICtail™/PICtail Plus Daughter Board. Items discussed in this chapter include:

- [Document Layout](#)
- [Conventions Used in this Guide](#)
- [Recommended Reading](#)
- [The Microchip Web Site](#)
- [Development Systems Customer Change Notification Service](#)
- [Customer Support](#)
- [Document Revision History](#)

DOCUMENT LAYOUT

This document describes how to use the RN2903 LoRa Technology PICtail/PICtail Plus Daughter Board as a development tool to emulate and debug firmware on a target board, as well as how to program devices.

The document is organized as follows:

- **Chapter 1. “Overview”** – This chapter describes the RN2903 LoRa Technology PICtail/PICtail Plus Daughter Board and presents various board configurations.
- **Chapter 2. “Getting Started”** – This chapter describes the two main communication modes and the hardware requirements for getting started with RN2903 LoRa Technology PICtail/PICtail Plus Daughter Board.
- **Appendix A. “Board Schematic and PCB Details”** – This appendix provides the RN2903 LoRa Technology PICtail/PICtail Plus Daughter Board’s schematic, PCB layouts, and Bill of Materials (BOM).

CONVENTIONS USED IN THIS GUIDE

This manual uses the following documentation conventions:

DOCUMENTATION CONVENTIONS

Description	Represents	Examples
Arial font:		
Italic characters	Referenced books	<i>MPLAB® IDE User's Guide</i>
	Emphasized text	...is the <i>only</i> compiler...
Initial caps	A window	the Output window
	A dialog	the Settings dialog
	A menu selection	select Enable Programmer
Quotes	A field name in a window or dialog	"Save project before build"
Underlined, italic text with right angle bracket	A menu path	<u>File</u> > <i>Save</i>
Bold characters	A dialog button	Click OK
	A tab	Click the Power tab
N'Rnnnn	A number in verilog format, where N is the total number of digits, R is the radix and n is a digit.	4'b0010, 2'hF1
Text in angle brackets < >	A key on the keyboard	Press <Enter>, <F1>
Courier New font:		
Plain Courier New	Sample source code	#define START
	Filenames	autoexec.bat
	File paths	c:\mcc18\h
	Keywords	_asm, _endasm, static
	Command-line options	-Opa+, -Opa-
	Bit values	0, 1
	Constants	0xFF, 'A'
Italic Courier New	A variable argument	<i>file.o</i> , where <i>file</i> can be any valid filename
Square brackets []	Optional arguments	mcc18 [options] <i>file</i> [options]
Curly brackets and pipe character: { }	Choice of mutually exclusive arguments; an OR selection	errorlevel {0 1}
Ellipses...	Replaces repeated text	var_name [, var_name...]
	Represents code supplied by user	void main (void) { ... }

RECOMMENDED READING

This user's guide describes how to use RN2903 LoRa Technology PICtail/PICtail Plus Daughter Board. Other useful documents are listed below. The following Microchip documents are available and recommended as supplemental reference resources:

RN2903 Low-Power Long Range LoRa™ Technology Transceiver Module Data Sheet (DS50002390)

This data sheet provides detailed specifications for the RN2903 module.

RN2903 LoRa™ Technology Module Command Reference User's Guide (DS40001811)

This command reference user's guide describes how to configure the RN2903 module and includes a description of communication and command references.

THE MICROCHIP WEB SITE

Microchip provides online support via our web site at www.microchip.com. This web site is used as a means to make files and information easily available to customers. Accessible by using your favorite Internet browser, the web site contains the following information:

- **Product Support** – Data sheets and errata, application notes and sample programs, design resources, user's guides and hardware support documents, latest software releases and archived software
- **General Technical Support** – Frequently Asked Questions (FAQs), technical support requests, online discussion groups, Microchip consultant program member listing
- **Business of Microchip** – Product selector and ordering guides, latest Microchip press releases, listing of seminars and events, listings of Microchip sales offices, distributors and factory representatives

DEVELOPMENT SYSTEMS CUSTOMER CHANGE NOTIFICATION SERVICE

Microchip's customer notification service helps keep customers current on Microchip products. Subscribers will receive e-mail notification whenever there are changes, updates, revisions or errata related to a specified product family or development tool of interest.

To register, access the Microchip web site at www.microchip.com, click on Customer Change Notification and follow the registration instructions.

The Development Systems product group categories are:

- **Compilers** – The latest information on Microchip C compilers and other language tools
- **Emulators** – The latest information on the Microchip MPLAB® REAL ICE™ in-circuit emulator
- **In-Circuit Debuggers** – The latest information on the Microchip in-circuit debuggers. This includes MPLAB ICD 3 in-circuit debuggers and PICkit™ 3 debug express
- **MPLAB X IDE** – The latest information on Microchip MPLAB X IDE, the Windows® Integrated Development Environment for development systems tools
- **Programmers** – The latest information on Microchip programmers including the PICkit™ 3 development programmer

CUSTOMER SUPPORT

Users of Microchip products can receive assistance through several channels:

- Distributor or Representative
- Local Sales Office
- Field Application Engineer (FAE)
- Technical Support

Customers should contact their distributor, representative or field application engineer (FAE) for support. Local sales offices are also available to help customers. A listing of sales offices and locations is included in the back of this document.

Technical support is available through the web site at:
<http://www.microchip.com/support>.

DOCUMENT REVISION HISTORY

Revision A (October 2015)

This is the initial release of this document.



RN2903 LoRa™ TECHNOLOGY PICtail™/PICtail PLUS DAUGHTER BOARD USER'S GUIDE

Chapter 1. Overview

1.1 INTRODUCTION

The RN2903 LoRa™ Technology PICtail™/PICtail Plus Daughter Board is a demonstration board that showcases the Microchip RN2903 Low-Power Long Range, LoRa™ Technology Transceiver Module.

The RN2903 LoRa Technology PICtail/PICtail Plus Daughter Board provides access to the RN2903 UART and General Purpose Input and Output (GPIO) ports.

This chapter includes the following topics:

- [Features](#)
- [Contents](#)
- [Board Configuration](#)

1.2 FEATURES

The RN2903 LoRa Technology PICtail/PICtail Plus Daughter Board has the following features as represented in [Figure 1-1](#):

1. Microchip RN2903 Low-Power Long Range, LoRa™ Technology Transceiver Module
2. SMA connector for 915 MHz band
3. Solder pads around the module for GPIOs, power pins, and communication signals
4. Supply current measurement points
5. On-board LDO
6. UART traffic LEDs
7. ICSP header to program the on-board PIC18 MCU
8. USB connector
9. PICtail connection interface
10. PICtail Plus connection interface
11. PIC18 MCU for custom functions

FIGURE 1-1: RN2903 LoRa™ TECHNOLOGY PICtail™/PICtail PLUS DAUGHTER BOARD

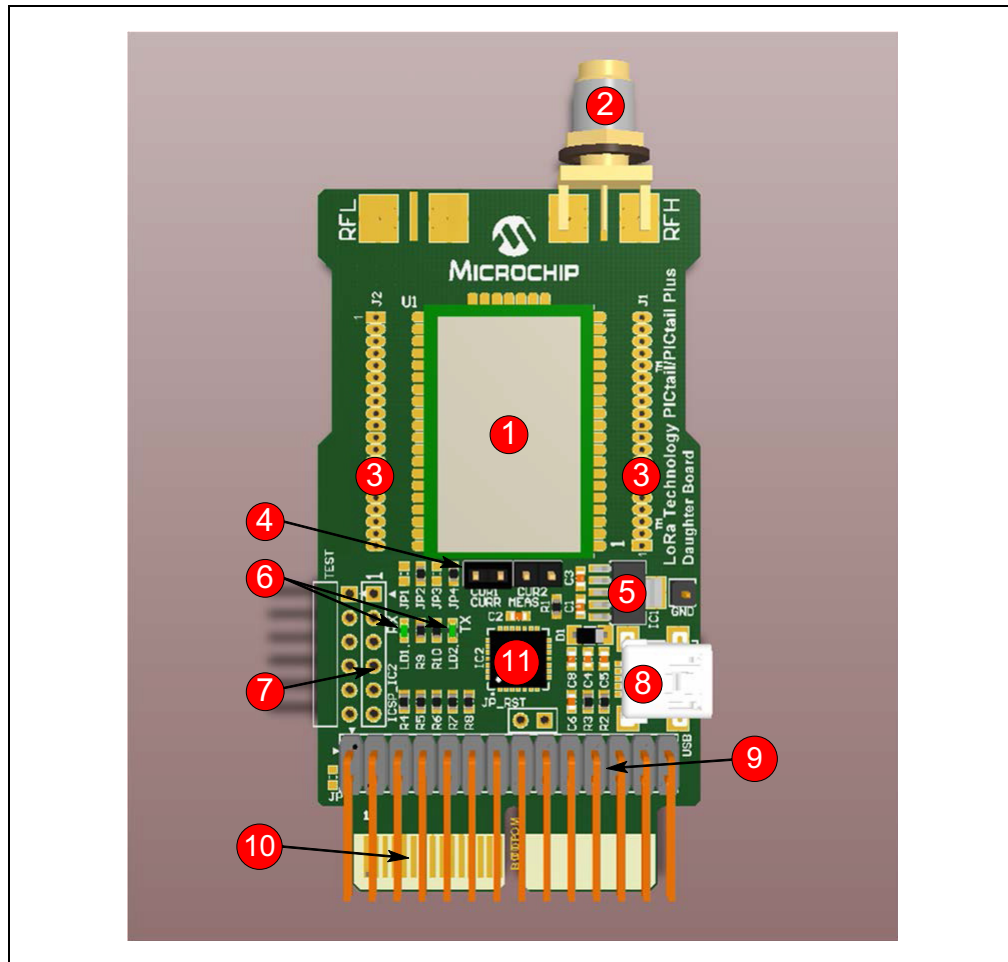

The high-speed UART interface and the GPIO ports are available on the module to configure, control, and transfer data. The RN2903 LoRa Technology PICtail/PICtail Plus Daughter Board has PICtail and PICtail Plus connectors to interface with a PIC® Microcontroller (MCU) on the development boards that support PICtail or PICtail Plus interface with the required pin mapping. The PICtail board also has an on-board PIC18 MCU preprogrammed to provide a simple USB-to-UART serial bridge, enabling easy serial connection. This MCU is available for custom user functions by reprogramming. The demonstration of the RN2903 is performed by plugging the daughter board into a USB port of a PC. The USB port powers the daughter board and enables the user to communicate using the RN2903's ASCII commands.

The development of the RN2903 with Microchip's PIC MCU line is either possible by plugging the 28-pin PICtail connector into a PIC18 Explorer, or by plugging into the 30-pin card edge PICtail Plus connector to an Explorer 16.

1.3 CONTENTS

The package kit contents contain the following tools as listed in [Table 1-1](#).

TABLE 1-1: RN2903 LoRa™ TECHNOLOGY PICtail™/PICtail PLUS DAUGHTER BOARD

Description	Part Number
RN2903 LoRa™ Technology PICtail™/PICtail Plus Daughter Board	RN-2903-PICtail
USB Cable	—
915 MHz antenna	—

1.4 BOARD CONFIGURATION

Prior to plugging the module into the motherboard's socket, ensure that one of the current measure jumpers, CUR1 or CUR2, are shunted.

PICtail Daughter Board can be powered from two sources, either from one of the PICtail headers or from USB. Both power sources can be active at the same time.

RF antenna must be connected to the SMA connector before attaching power supply to the board.

Ensure that the applied power supply voltage does *not* exceed board limits. [Figure 1-2](#), [Figure 1-3](#), and [Figure 1-4](#) show the connections to various development boards.

FIGURE 1-2: RN2903 LoRa™ TECHNOLOGY PICtail™/PICtail PLUS DAUGHTER BOARD CONNECTED TO EXPLORER 16 DEVELOPMENT BOARD

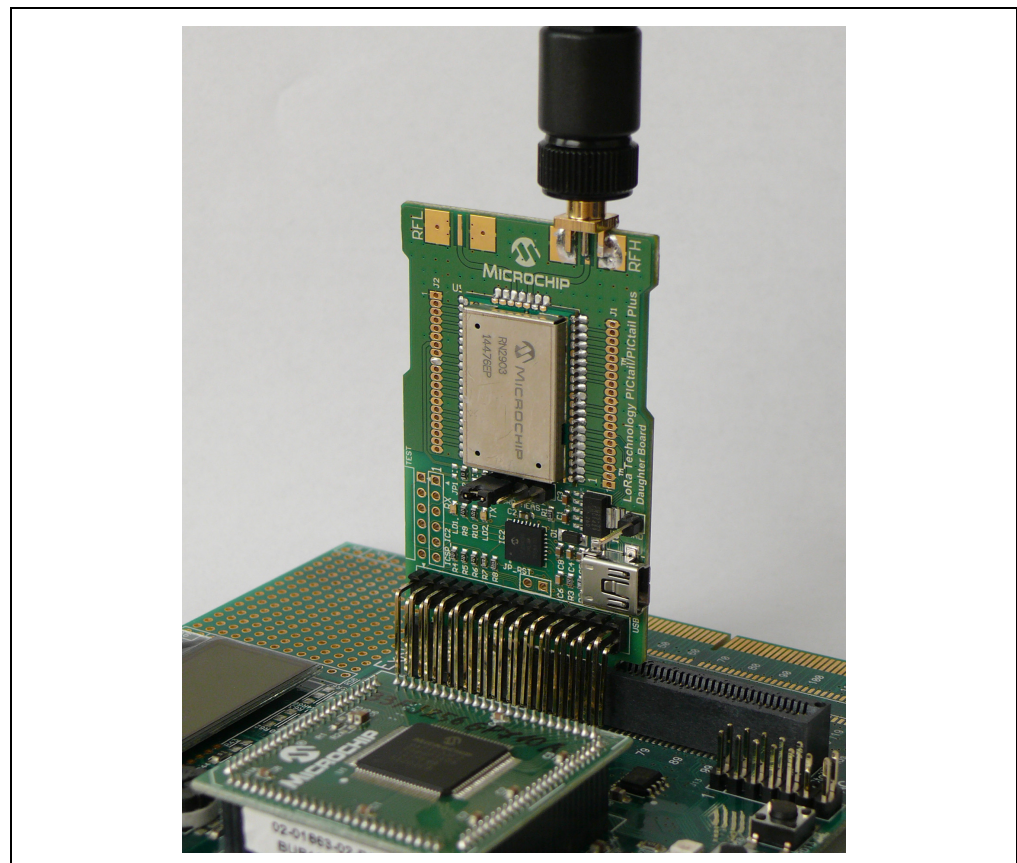

FIGURE 1-3: RN2903 LoRa™ TECHNOLOGY PICtail™/PICtail PLUS DAUGHTER BOARD CONNECTED TO PIC18 WIRELESS DEVELOPMENT BOARD

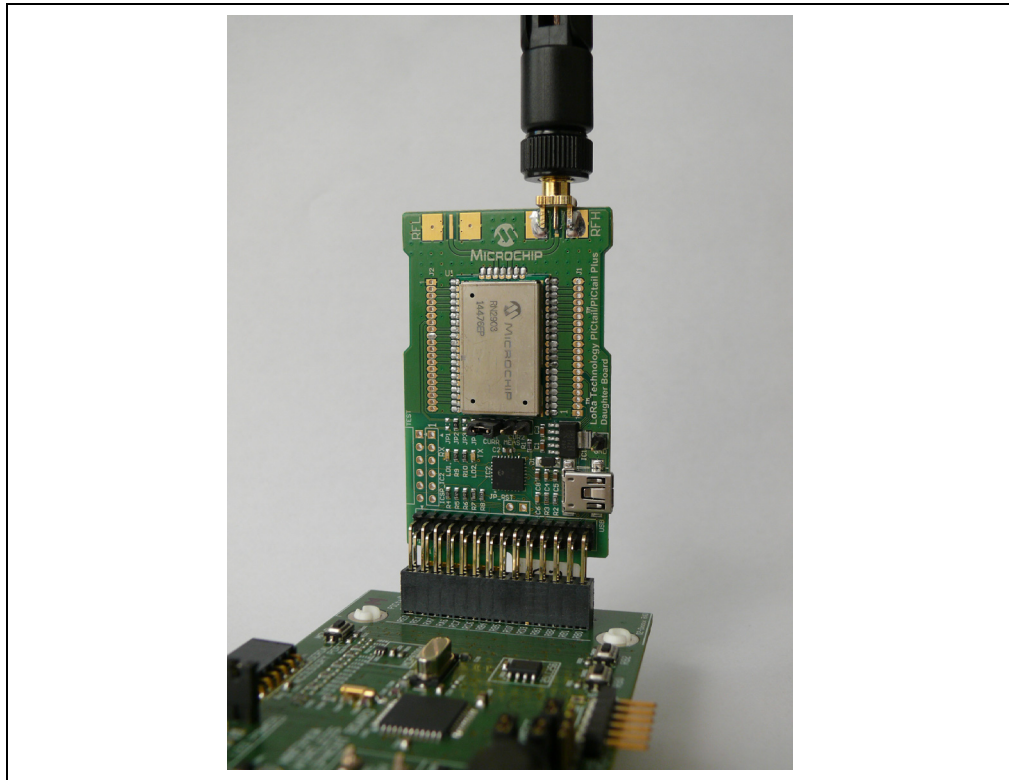
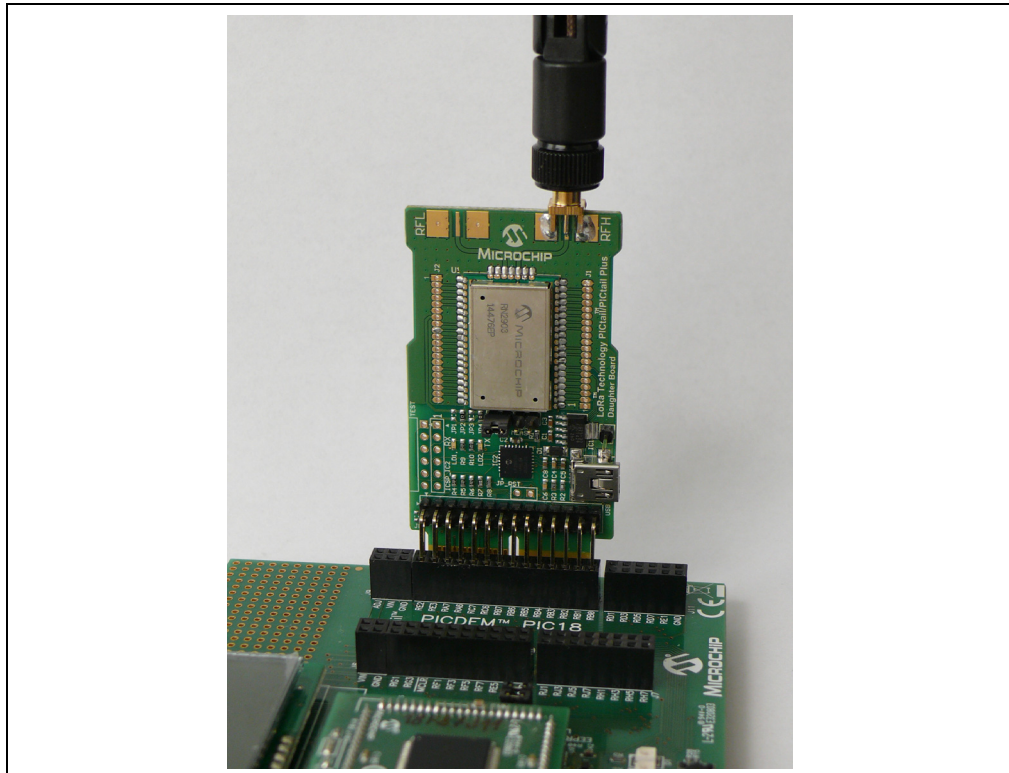

FIGURE 1-4: RN2903 LoRa™ TECHNOLOGY PICtail™/PICtail PLUS DAUGHTER BOARD CONNECTED TO PICDEM™ PIC18 EXPLORER DEMONSTRATION BOARD



Chapter 2. Getting Started

2.1 INTRODUCTION

This chapter describes the hardware requirements for RN2903 LoRa Technology PICtail/PICtail Plus Daughter Board.

The module accepts commands via UART interface. The UART interface can be routed either to the onboard USB port or one of the PICtail or PICtail Plus connector. Basically, two communication modes are supported by the daughter board, USB mode and PICtail mode.

PICtail mode gives more computing power to the user program, since motherboards contain additional MCUs.

This chapter includes the following topics:

- [Communication Modes](#)
- [Communication to the Module](#)
- [Hardware Description](#)

2.2 COMMUNICATION MODES

2.2.1 USB mode

The USB mode is initiated when the daughter board is connected to a USB port via a mini-USB cable. In this mode, the on-board PIC18 MCU provides a USB-to-UART bridge.

Supply voltage is provided via USB and the on-board LDO (IC1) which regulates 5V to the nominal 3.3V.

2.2.2 PICtail mode

The PICtail mode is initiated when no USB cable is attached to the board, and the board is plugged into the appropriate motherboard.

Note: The user must ensure that the PICtail/PICtail Plus port pins are fully compatible with the pinout of the daughter board.

When the daughter board is *not* powered from the USB, the on-board PIC18 MCU does *not* influence UART communication.

Note: Some motherboards may adjust the supply voltage to the attached MCU Plug-in Module. Do *not* exceed the supply voltage limits of the module.

2.2.3 USB mode while the board is powered from the PICtail

The daughter board can be used in a third mode when it is connected to a PICtail motherboard while the USB is also connected. It is useful when the user wants to set the supply voltage from the PICtail connector while the communication must be continuously active via the USB interface. The on-board PIC18 MCU takes over the

control of the UART interface. In this case, the motherboard is unable to send UART messages to the module. However, the messages sent by the module are seen on the PICtail UART's Module_TX line.

In instances wherein the motherboard does *not* have power supply, it can be powered from the USB together with the daughter board. The user must take care of the maximum output current of the on-board LDO, which is 500 mA.

A short on the jumper JP_RST on the daughter board forces the board to operate in PICtail mode, although the USB remains connected. The jumper JP_RST keeps the on-board PIC18 MCU in Reset state to ensure that USB-to-UART protocol translation is *not* performed in this mode. If the jumper JP_RST is *not* shorted, the on-board PIC18 MCU has the priority over the UART communication. This function is only available with the 30-pin PICtail Plus connection, not for the 28-pin PICtail platform.

2.3 COMMUNICATION TO THE MODULE

In PICtail mode, the Microchip 8/16/32-bit PIC MCUs on the motherboards can run custom functions and connect to the module using the UART interface, which accepts ASCII commands from the host.

In USB mode, when the daughter board is connected to the host via USB, the on-board PIC18 MCU uses the CDC class to create a USB-to-UART bridge device. The host can run a simple terminal emulator application to issue commands.

2.4 HARDWARE DESCRIPTION

The RF signal path is connected to the SMA edge connector. The current consumption measurement of the module is supported by the on-board current measure jumpers. If jumper CUR1 is shunted, the supply current flows directly to the module.

There are two ways to measure current consumption:

1. A current meter can be connected to CUR1 jumper pins to measure the actual current consumption of the module. CUR2 must be left open.
2. The current consumption graph can be recorded in the time domain by removing the shunt from CUR1 jumper and shunting CUR2 at the same time. Use a two-channel oscilloscope, which supports subtracting mathematical function. Connect oscilloscope probes to CUR1 jumper pins while CUR2 jumper is shunted. Set the oscilloscope to display the difference between the two channels.

All pins of the module can be accessed via through hole pads which are classified into two groups located on both sides of the module. The user can mount two 1.27 mm pitched socket headers if required. Sockets can connect the module pins to a custom board, whereas the daughter board provides the power. Both through hole pad groups, J1 and J2, have dedicated pads on which power is delivered to the custom board. The supply current is measured together with the module's supply current. To do this, JP2 must be shorted for J2 and JP3 shorted for J1.

If the supply current is separated from the module, the two other jumpers must be shorted. To power the custom board separately, shunt JP1 or JP4.

The on-board PIC18 MCU is programmable via programming port ICSP_IC2. In USB mode, LD1 and LD2 LEDs indicate communication on the UART.

Table 2-1 shows the PICtail/PICtail Plus connections to various boards.

TABLE 2-1: PICtail AND PICtail PLUS CONNECTIONS

Signal Name	Description	Pin number on PICtail connector	Pin number on PICtail Plus connector
+3V3	Positive Supply Rail	26	21, 22
GND	Ground Supply Rail	28	9, 10, 16
Module_TX	UART transmit output of the module	21	2
Module_RX	UART receive input of the module	17	4
Module_RTS	UART Hardware handshake output of the module ⁽¹⁾	4	19
Module_CTS	UART Hardware handshake input of the module ⁽¹⁾	3	20
PT_Module_RESET	Master Clear input of the module	1	6
PT+_SENSE	Sensing signal for PICtail Plus connector (The platform connects this line to GND when plugged.)	—	15

Note 1: Optional handshake lines are supported in future firmware releases.

NOTES:



RN2903 LoRa™ TECHNOLOGY PICtail™/PICtail PLUS DAUGHTER BOARD USER'S GUIDE

Appendix A. Board Schematic and PCB Details

A.1 INTRODUCTION

This appendix provides the RN2903 LoRa Technology PICtail/PICtail Plus Daughter Board schematic, PCB layout, and Bill of Materials (BOM).

- [Board Schematic](#)
- [PCB Layout](#)
- [Bill of Materials](#)

A.2 BOARD SCHEMATIC

[Figure A-1](#) shows the board schematic.

FIGURE A-1: RN2903 LoRa™ TECHNOLOGY PICtail™/PICtail PLUS DAUGHTER BOARD SCHEMATIC

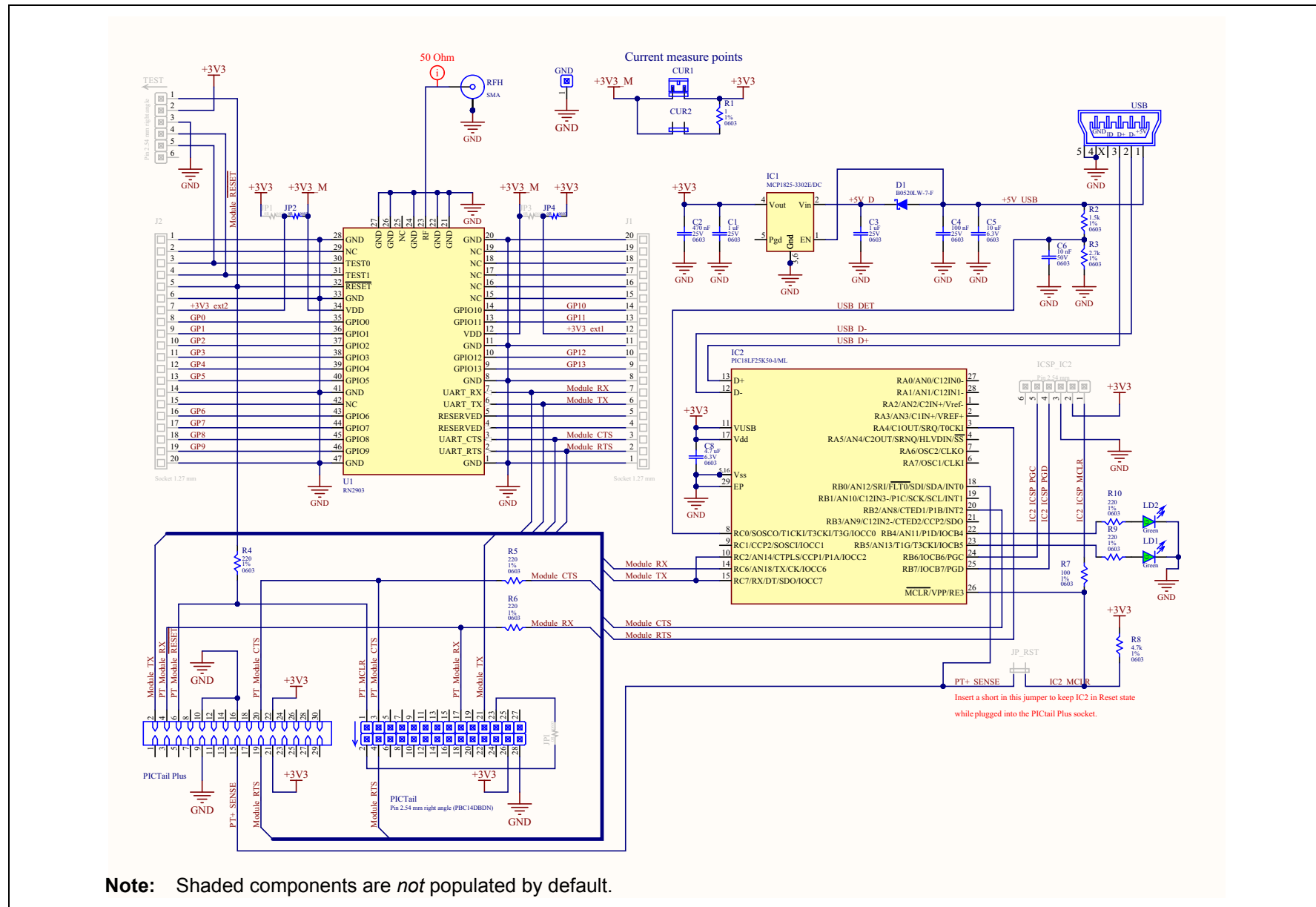

A.3 PCB LAYOUT

RN2903 LoRa Technology PICtail/PICtail Plus Daughter Board is a 2-layer, FR4, 1.55 mm, plated through hole PCB construction.

Figure A-2 through Figure A-4 illustrate the PCB layers, and Figure A-5 shows the assembly drawing of LoRa Technology PICtail/PICtail Plus Daughter Board.

FIGURE A-2: RN2903 LoRa™ TECHNOLOGY PICtail™/PICtail PLUS DAUGHTER BOARD TOP SILKSCREEN

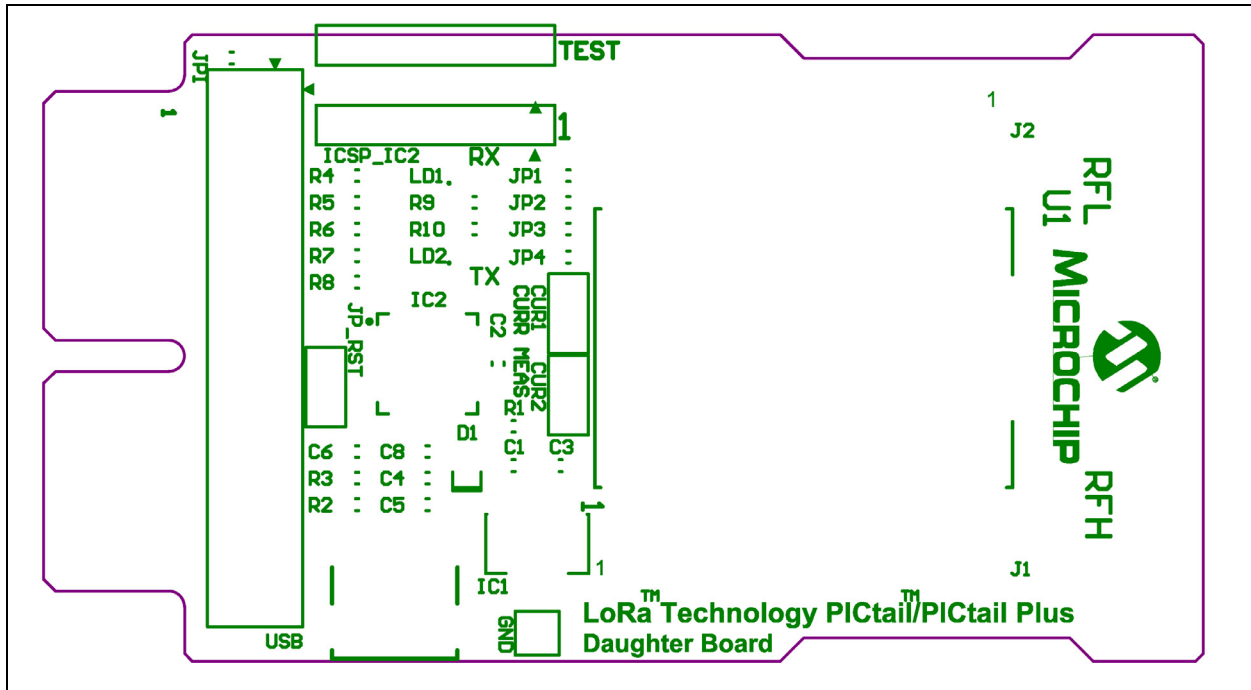

FIGURE A-3: RN2903 LoRa™ TECHNOLOGY PICtail™/PICtail PLUS DAUGHTER BOARD TOP COPPER

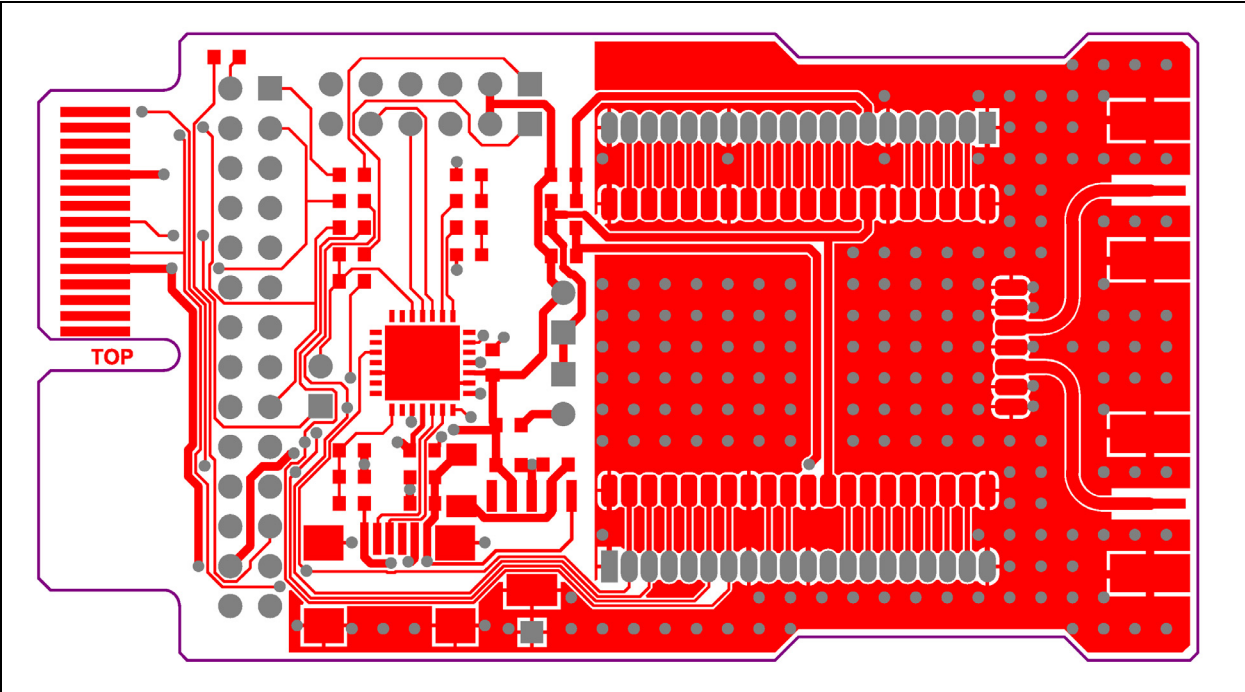

FIGURE A-4: RN2903 LoRa™ TECHNOLOGY PICtail™/PICtail PLUS DAUGHTER BOARD BOTTOM COPPER (BOTTOM VIEW)

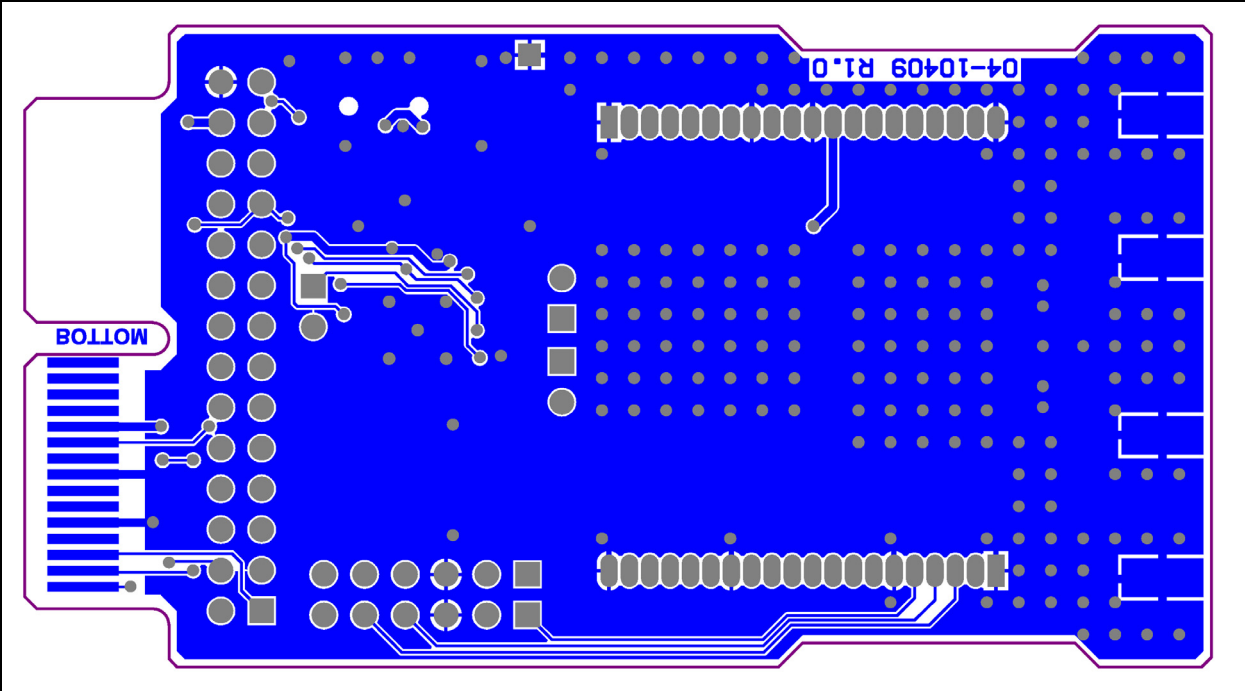
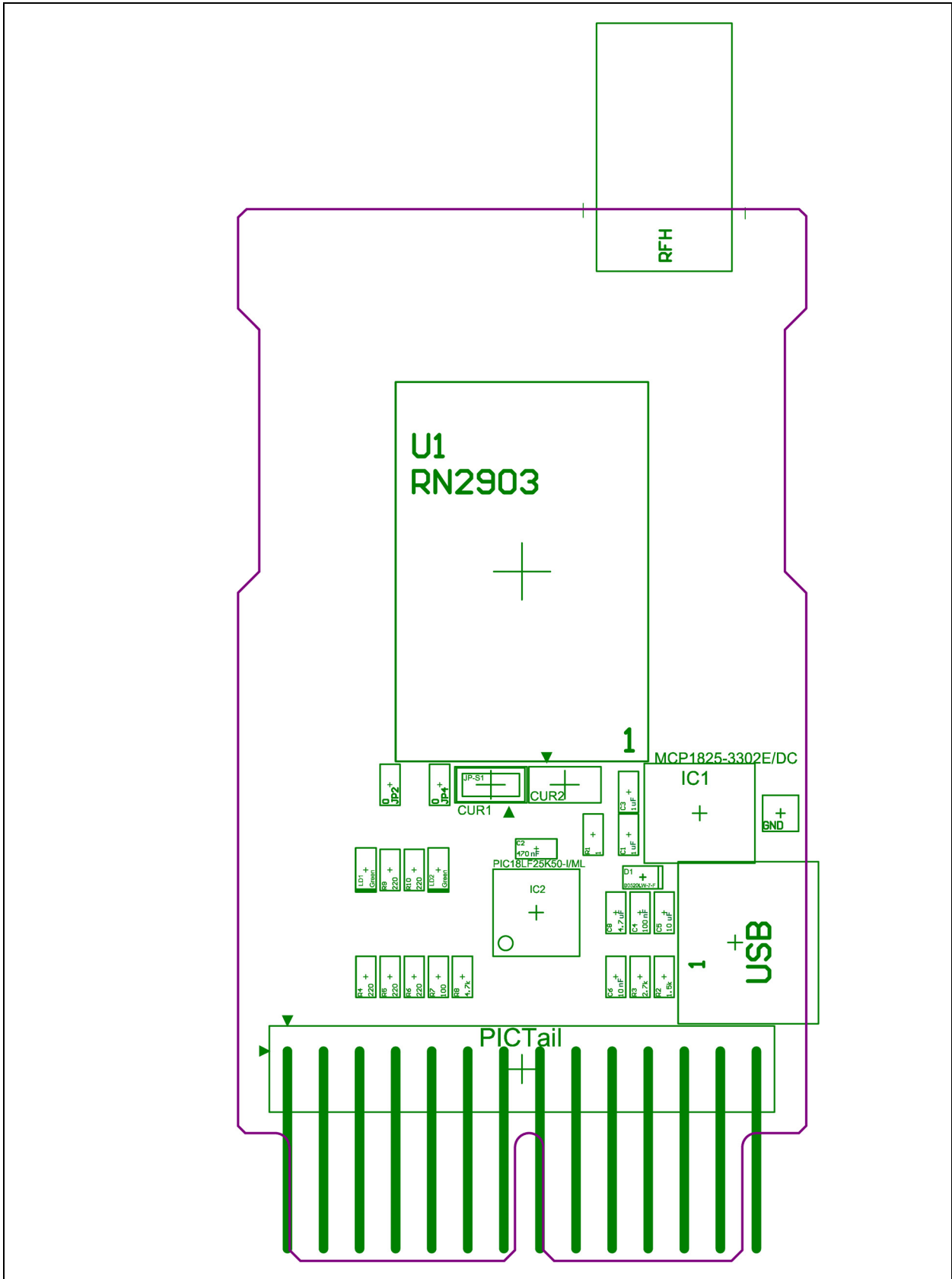

FIGURE A-5: RN2903 LoRa™ TECHNOLOGY PICtail™/PICtail PLUS DAUGHTER BOARD TOP ASSEMBLY



A.4 BILL OF MATERIALS

TABLE A-1: RN2903 LoRa™ TECHNOLOGY PICTail™/PICTail PLUS DAUGHTER BOARD BILL OF MATERIALS (BOM)

Reference	Value	Description	Vendor	Vendor P/N
C1, C3	1 μ F	CAP, 0603, 25V, 10%, X7R	Murata Electronics North America	GRM188R71E105KA12D
C2	470 nF	CAP, 0603, 25V, 10%, X7R	Murata Electronics North America	GRM188R71E474KA12D
C4	100 nF	CAP, 0603, 25V, Y5V	Yageo	CC0603ZRY5V8BB104
C5	10 μ F	CAP, 0603, 6.3V, 20%, X5R	Murata Electronics North America	GRM188R60J106ME47D
C6	10 nF	CAP, 0603, 50V, 10%, X7R	Murata Electronics North America	GRM188R71H103KA01D
C8	4.7 μ F	CAP, 0603, 6.3V, 10%, X5R	Murata Electronics North America	GRM188R60J475KE19D
CUR1, CUR2	—	CONN Pin 2 2.54 mm_jumper	Harwin, Inc.	M20-9990245
D1	—	DIODE SCHOTTKY 20V 0.5A SOD123	Diodes, Inc.	B0520LW-7-F
GND	—	CONN Pin 1	Keystone	5012
IC1	—	IC MCP1825-3302E/DC	Microchip	MCP1825-3302E/DC
IC2	—	IC PIC18LF25K50-I/ML	Microchip	PIC18LF25K50-I/ML
JP2, JP4	—	RES 0 OHM 0603 JUMPER 2P	Vishay Dale	CRCW06030000Z0EA
JP-S1	—	JUMPER SHUNT 2POS 2.54 mm LOPRO GOLD	TE Connectivity	382811-8
LD1, LD2	—	LED 565NM GRN DIFF 0603	Lumex Opto/Components, Inc.	SML-LX0603GW-TR
PICTail	—	CONN Pin 14x2 2.54 mm right angle (PBC14DBDN)	Sullins Connector Solutions	PBC14DBDN
R1	1.00 Ω	RES 0603 1/10W 1%	Yageo	RC0603FR-071RL
R2	1.50 k Ω	RES 0603 1/10W 1%	Vishay Dale	CRCW06031K50FKEA
R3	2.70 k Ω	RES 0603 1/10W 1%	Vishay Dale	CRCW06032K70FKEA
R4, R5, R6, R9, R10	220 Ω	RES 0603 1/10W 1%	Vishay Dale	CRCW0603220RFKEA
R7	100 Ω	RES 0603 1/10W 1%	Vishay Dale	CRCW0603100RFKEA
R8	4.70 k Ω	RES 0603 1/10W 1%	Vishay Dale	CRCW06034K70FKEA
RFH	—	CONN JACK SMA 50 OHM EDGE MOUNT	Cinch Connectivity Solutions Johnson	142-0711-821
U1	—	RF module RN2903 LoRa 915 MHz	Microchip	RN2903
USB	—	CONN MINI B USB R/A SMD	Hirose	UX60-MB-5ST



MICROCHIP

Worldwide Sales and Service

AMERICAS

Corporate Office

2355 West Chandler Blvd.
Chandler, AZ 85224-6199
Tel: 480-792-7200
Fax: 480-792-7277
Technical Support:
<http://www.microchip.com/support>

Web Address:

www.microchip.com

Atlanta

Duluth, GA
Tel: 678-957-9614
Fax: 678-957-1455

Austin, TX

Tel: 512-257-3370

Boston

Westborough, MA
Tel: 774-760-0087
Fax: 774-760-0088

Chicago

Itasca, IL
Tel: 630-285-0071
Fax: 630-285-0075

Cleveland

Independence, OH
Tel: 216-447-0464
Fax: 216-447-0643

Dallas

Addison, TX
Tel: 972-818-7423
Fax: 972-818-2924

Detroit

Novi, MI
Tel: 248-848-4000

Houston, TX

Tel: 281-894-5983

Indianapolis

Noblesville, IN
Tel: 317-773-8323
Fax: 317-773-5453

Los Angeles

Mission Viejo, CA
Tel: 949-462-9523
Fax: 949-462-9608

New York, NY

Tel: 631-435-6000

San Jose, CA

Tel: 408-735-9110

Canada - Toronto

Tel: 905-673-0699
Fax: 905-673-6509

ASIA/PACIFIC

Asia Pacific Office

Suites 3707-14, 37th Floor
Tower 6, The Gateway
Harbour City, Kowloon

Hong Kong

Tel: 852-2943-5100
Fax: 852-2401-3431

Australia - Sydney

Tel: 61-2-9868-6733
Fax: 61-2-9868-6755

China - Beijing

Tel: 86-10-8569-7000
Fax: 86-10-8528-2104

China - Chengdu

Tel: 86-28-8665-5511
Fax: 86-28-8665-7889

China - Chongqing

Tel: 86-23-8980-9588
Fax: 86-23-8980-9500

China - Dongguan

Tel: 86-769-8702-9880

China - Hangzhou

Tel: 86-571-8792-8115
Fax: 86-571-8792-8116

China - Hong Kong SAR

Tel: 852-2943-5100
Fax: 852-2401-3431

China - Nanjing

Tel: 86-25-8473-2460
Fax: 86-25-8473-2470

China - Qingdao

Tel: 86-532-8502-7355
Fax: 86-532-8502-7205

China - Shanghai

Tel: 86-21-5407-5533
Fax: 86-21-5407-5066

China - Shenyang

Tel: 86-24-2334-2829
Fax: 86-24-2334-2393

China - Shenzhen

Tel: 86-755-8864-2200
Fax: 86-755-8203-1760

China - Wuhan

Tel: 86-27-5980-5300
Fax: 86-27-5980-5118

China - Xian

Tel: 86-29-8833-7252
Fax: 86-29-8833-7256

ASIA/PACIFIC

China - Xiamen

Tel: 86-592-2388138
Fax: 86-592-2388130

China - Zhuhai

Tel: 86-756-3210040
Fax: 86-756-3210049

India - Bangalore

Tel: 91-80-3090-4444
Fax: 91-80-3090-4123

India - New Delhi

Tel: 91-11-4160-8631
Fax: 91-11-4160-8632

India - Pune

Tel: 91-20-3019-1500

Japan - Osaka

Tel: 81-6-6152-7160
Fax: 81-6-6152-9310

Japan - Tokyo

Tel: 81-3-6880-3770
Fax: 81-3-6880-3771

Korea - Daegu

Tel: 82-53-744-4301
Fax: 82-53-744-4302

Korea - Seoul

Tel: 82-2-554-7200
Fax: 82-2-558-5932 or
82-2-558-5934

Malaysia - Kuala Lumpur

Tel: 60-3-6201-9857
Fax: 60-3-6201-9859

Malaysia - Penang

Tel: 60-4-227-8870
Fax: 60-4-227-4068

Philippines - Manila

Tel: 63-2-634-9065
Fax: 63-2-634-9069

Singapore

Tel: 65-6334-8870
Fax: 65-6334-8850

Taiwan - Hsin Chu

Tel: 886-3-5778-366
Fax: 886-3-5770-955

Taiwan - Kaohsiung

Tel: 886-7-213-7828

Taiwan - Taipei

Tel: 886-2-2508-8600
Fax: 886-2-2508-0102

Thailand - Bangkok

Tel: 66-2-694-1351
Fax: 66-2-694-1350

EUROPE

Austria - Wels

Tel: 43-7242-2244-39
Fax: 43-7242-2244-393

Denmark - Copenhagen

Tel: 45-4450-2828
Fax: 45-4485-2829

France - Paris

Tel: 33-1-69-53-63-20
Fax: 33-1-69-30-90-79

Germany - Dusseldorf

Tel: 49-2129-3766400

Germany - Karlsruhe

Tel: 49-721-625370

Germany - Munich

Tel: 49-89-627-144-0
Fax: 49-89-627-144-44

Italy - Milan

Tel: 39-0331-742611
Fax: 39-0331-466781

Italy - Venice

Tel: 39-049-7625286

Netherlands - Drunen

Tel: 31-416-690399
Fax: 31-416-690340

Poland - Warsaw

Tel: 48-22-3325737

Spain - Madrid

Tel: 34-91-708-08-90
Fax: 34-91-708-08-91

Sweden - Stockholm

Tel: 46-8-5090-4654

UK - Wokingham

Tel: 44-118-921-5800
Fax: 44-118-921-5820

07/14/15