

4 Attaching the 1.5" NPT Pipe to the Suspended Ceiling Adapter

IMPORTANT! Do not loosen screws all the way when making adjustments, this will disconnect the parts and may cause injury or property damage.

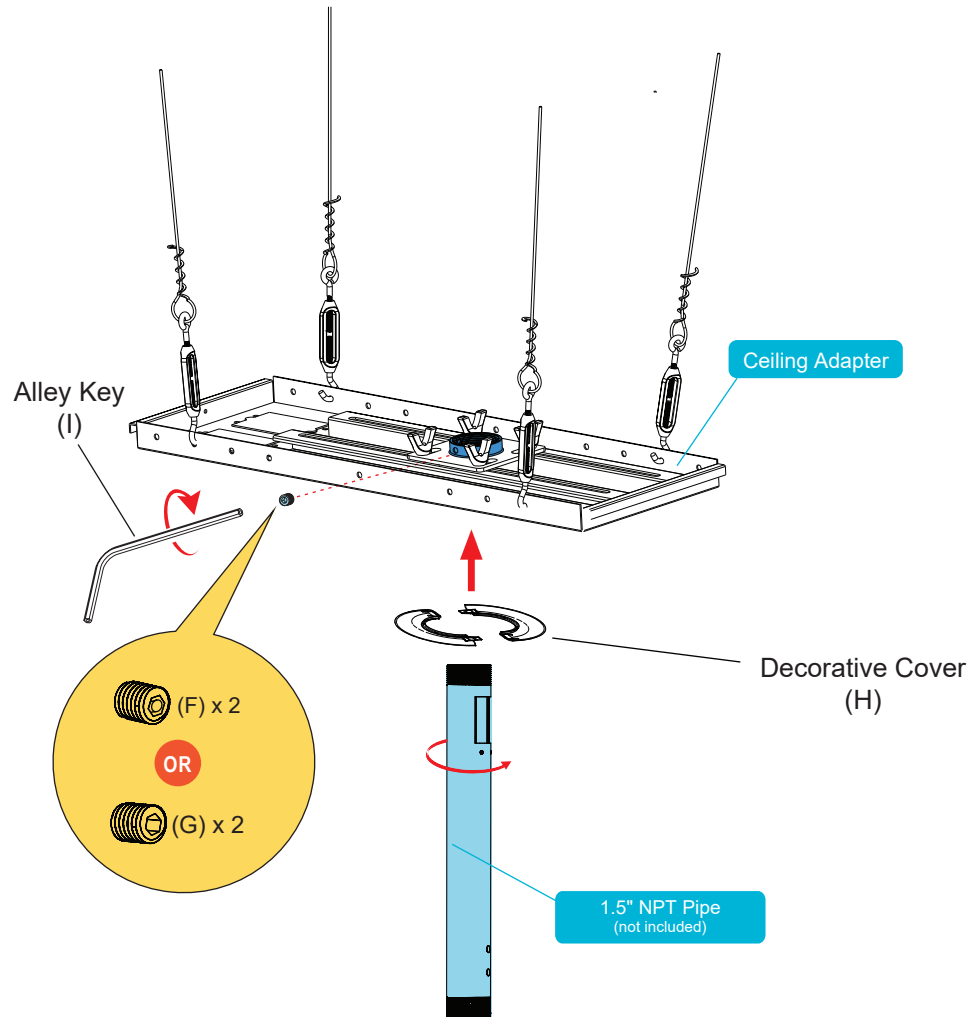

To connect the 1.5" NPT pipe (sold separately) to the ceiling adapter, twist the male threaded end into the female thread of the adapter. Then secure the position with screws (F or G) using the allen key (I). Decorative cover (H) can be attached post-installation to make the appearance look tidy.

QualGear[®]
Accessories that Inspire.

QG-PRO-PM-SCA-W
INSTALLATION MANUAL

ADJUSTABLE SUSPENDED CEILING ADAPTER

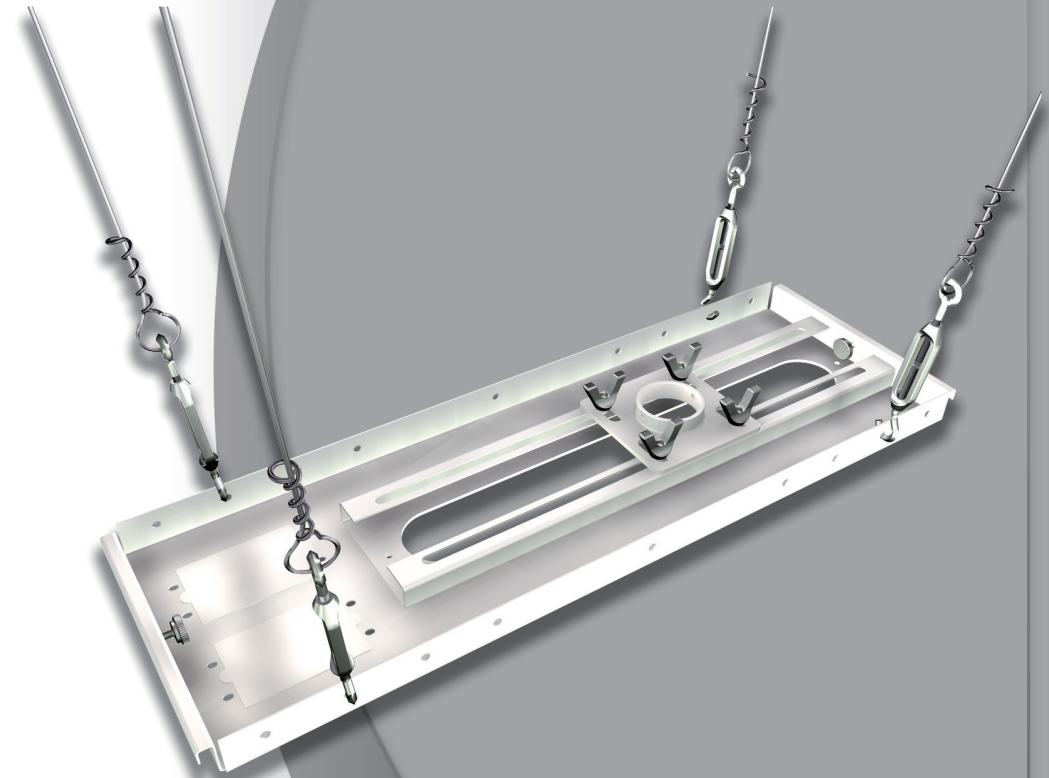

www.qualgear.com

**45.5kg
(100lbs)
RATED**

CAUTION!
Do not exceed the maximum rated weight specified. Otherwise, serious injury or property damage may occur.



■ 5 Year Limited Warranty

■ Version November 2015

NOTE Please read the entire installation manual before you start installation and assembly.

WARNING

- Do not begin to install your QualGear product until you have read and understood all the instructions and warnings contained in this installation manual. If you have any questions regarding the instructions, for US customers please contact QualGear customer support via email at support@qualgear.com. For all international customers, please contact your local distributor.
- This product should only be installed by someone of good mechanical aptitude, has experience with basic building construction, and fully understands these instructions.
- This product was designed to be installed and utilized only as specified in this manual. Improper installation of this product may cause damage or serious injury. QualGear is not liable for the improper use or installation of its products.
- Make sure that the supporting surface will safely support the combined load of the equipment and all attached hardware and components.
- Always use an assistant or mechanical lifting equipment to safely lift and position the equipment.
- Tighten screws firmly, but do not over tighten. Over tightening can damage the items, greatly reducing their holding power.
- ALL QUALGEAR products are intended for indoor use only and any outdoor use voids the limited warranty. For warranty information, please visit:
<http://www.qualgear.com/warranty.php>
- Never exceed the maximum rated weight specified in this manual.
- All hardware must be used at the designated points in the installation instructions to prevent property damage and/or personal injury.
- This product was designed to be compatible with all standard 1.5" NPT pipes.



IMPORTANT: Installers must verify that the supporting surface will safely support the combined weight of the equipment and all attached hardware and components.

Maintenance

Please check that the ceiling adapter is secure and safe to use at regular intervals. If you have any questions regarding any of the instructions or warnings, please contact your local distributor (OR) contact QualGear technical support via email at support@qualgear.com.

Parts Checklist



IMPORTANT: Before starting installation, please check that all parts shown in this checklist are included. If any parts are missing or damaged, contact your local distributor or support@qualgear.com for replacement parts and do not start assembly and installation until you receive all the parts.

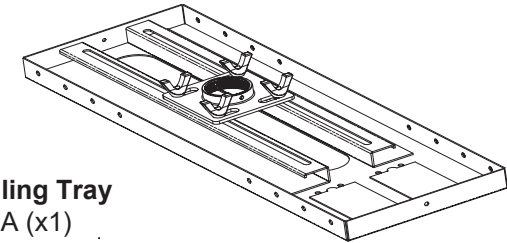

Ceiling Tray
A (x1)

Hardware Package

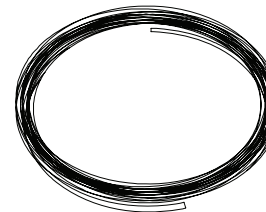

Wire
B (x1)



Concrete Anchors
C (x4)

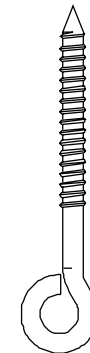

Eye Bolts
D (x4)

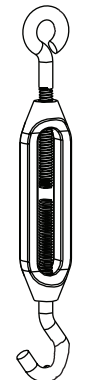

Turnbuckles
E (x4)



M5 x 5mm Security Screws
F (x2)



M5 x 5mm Screws
G (x2)

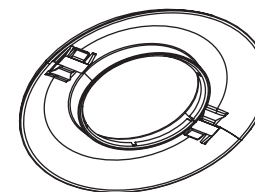

Decorative Cover
H (x1)



Allen Key
I (x1)

1a Mounting to a Wooden Joist or Wooden Stud Ceiling

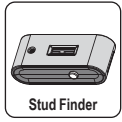

NOTE For concrete ceiling mounting, follow Step 1b, and for truss, follow Step 1c.

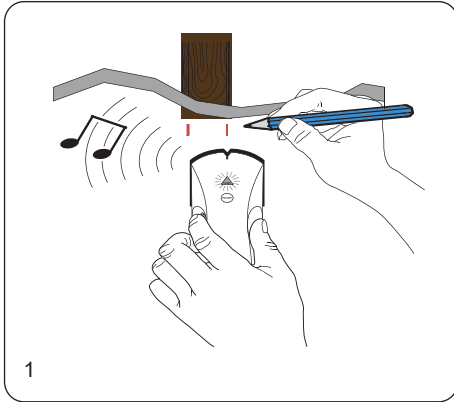

1 Using an edge-to-edge stud finder, find the edges of the stud.

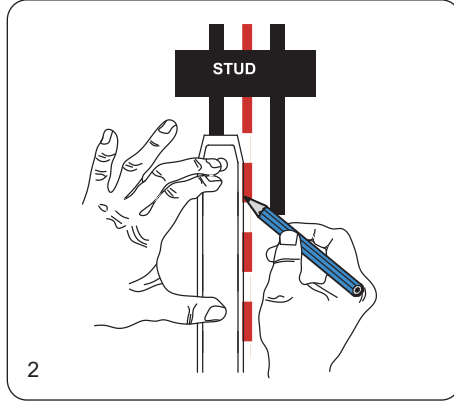

2 Using a straight edge, mark the centerline of the stud, and the locations of where you want to mount the ceiling adapter.

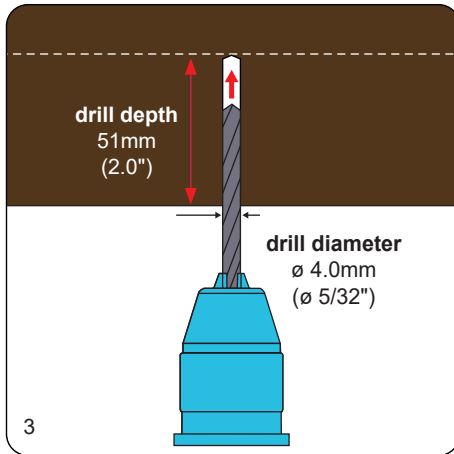

3 Using a power drill and a 5/32" wood drill bit, drill holes of 5/32" (4mm) diameter, and 2" (51mm) depth at the marked locations.

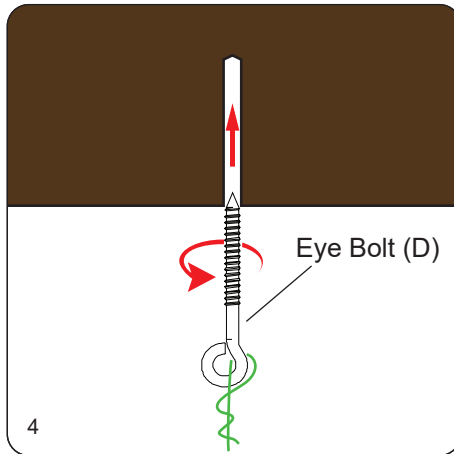

4 Install the eye bolts into the drilled holes, then loop wire (B) into the hole of the eye bolts and twist several times to secure.

TIP

Mark the drill locations on the center of the studs for security.

SKIP TO STEP 2 →

1b Mounting to a Concrete Ceiling

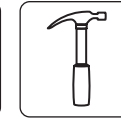
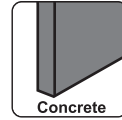

TIP Make sure drilled holes are free of dust so the anchors will be set properly.

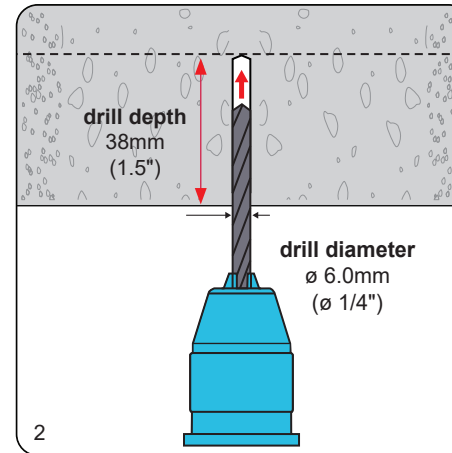

2 Using a power drill and a 1/4" masonry drill bit, drill four holes of 1/4" (6.0 mm) diameter and 1.5" (38 mm) depth at the marked locations.

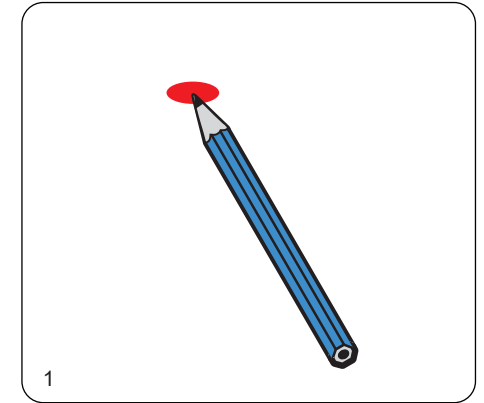
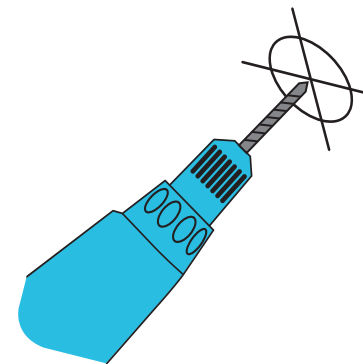

1 Mark the locations of where you want to mount your suspended ceiling adapter.

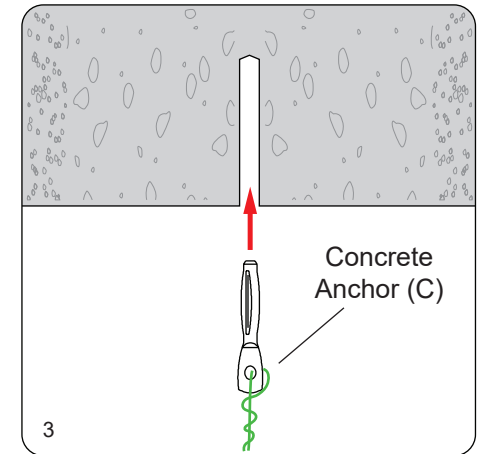

3 Insert and hammer the concrete anchors (C) into the drilled holes. Loop a wire at the end of each anchor and twist around itself a few times to secure.

SKIP TO STEP 2 →

1c Mounting to a Truss

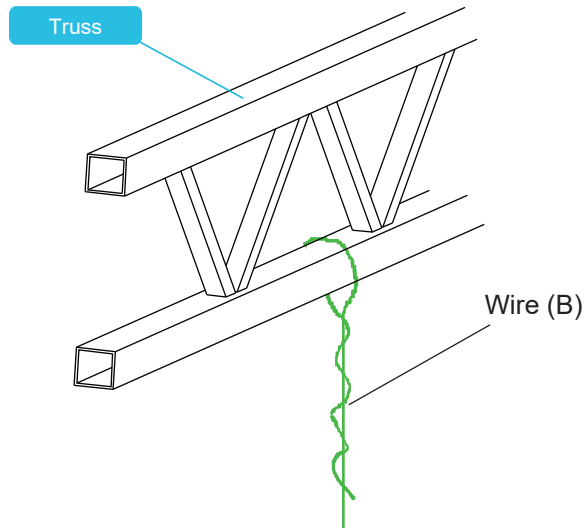

Loop wire around the truss and twist around itself several times to secure.

2 Attaching the Ceiling Tray to the Suspended Wire

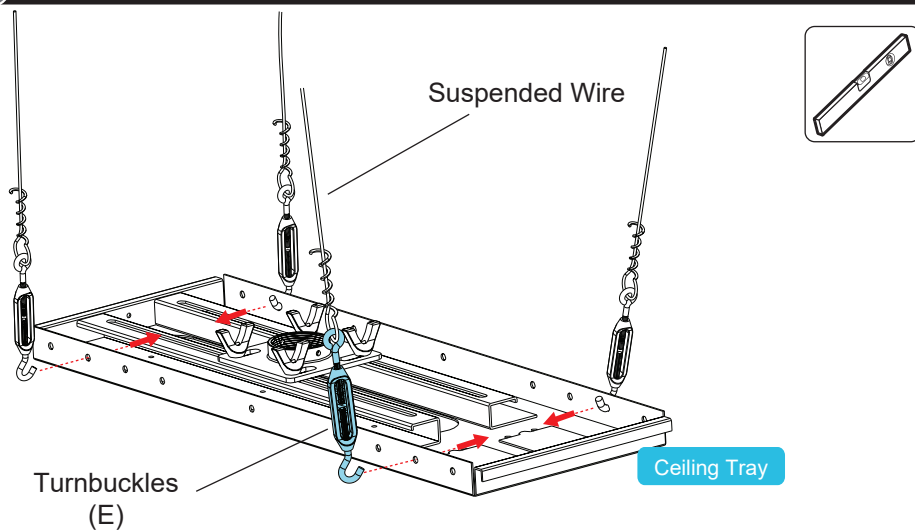

Attach the suspended wire from previous step to the turnbuckles (E). Hook turnbuckles to the ceiling tray and adjust until the ceiling tray is leveled and suspended above the ceiling tile.

3 Adjusting the Collar Position

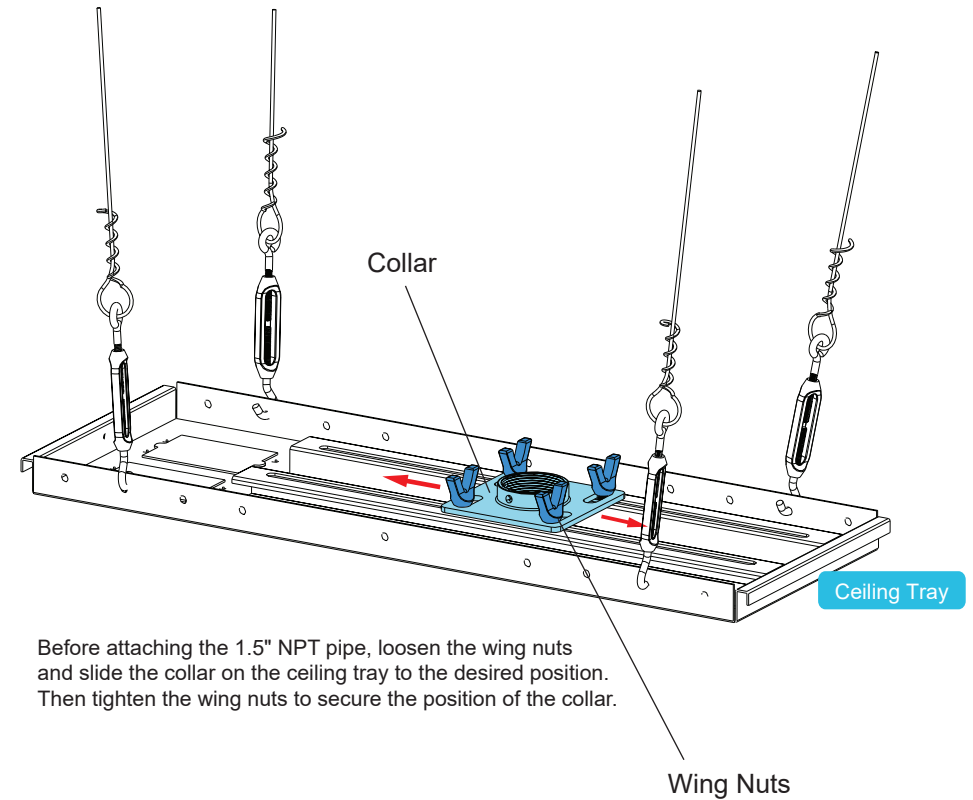

Before attaching the 1.5" NPT pipe, loosen the wing nuts and slide the collar on the ceiling tray to the desired position. Then tighten the wing nuts to secure the position of the collar.

NOTE

Collar can be adjusted to the desired position by sliding within a distance of 1' (310mm).

WARNING

- Installers are responsible to provide hardware for other types of mounting situations.
- Installers must verify that the supporting surface will safely support the combined weight of the equipment and all attached hardware and components.