

DATE	REV	ECN	APP'D. BY
1-19-15	A3	10212	TRM
2-26-16	A4	10568	TRM

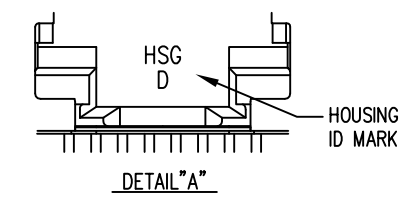

- NOTES:
- CONNECTOR MATERIALS:
HOUSING: THERMOPLASTIC UL94 V-0
CONTACTS/SHIELD: COPPER ALLOY
SHIELD PLATING: NICKEL
CONTACT PLATING: SELECTIVE GOLD IN CONTACT AREA
SEE CHART FOR PART NUMBER
 - FOR PRODUCT SPECIFICATION SEE PR022-01.
 - PART IS WAVE SOLDER COMPATIBLE ONLY
 - RATED AT MAX. 260°C FOR MAX. 10 SECS.
 - DIMENSIONS AND TOLERANCES COMPLY WITH FCC/CFR 47, PART 68.
 - THE SUGGESTED PANEL OPENING IS INTENDED TO GIVE USER THE ABILITY TO HAVE REASONABLE JACK/PANEL CLEARANCES, YET MAINTAIN GROUNDING CAPABILITY. THESE VARIABLES CAN BE ADJUSTED IN EITHER DIRECTION BUT MAY CARRY SOME CONSEQUENCES IN THE FORM OF LOWER MATING FORCES OR TIGHTER ASSEMBLY TOLERANCES.
 - DESIGNED FOR CATEGORY 5/5e APPLICATIONS.

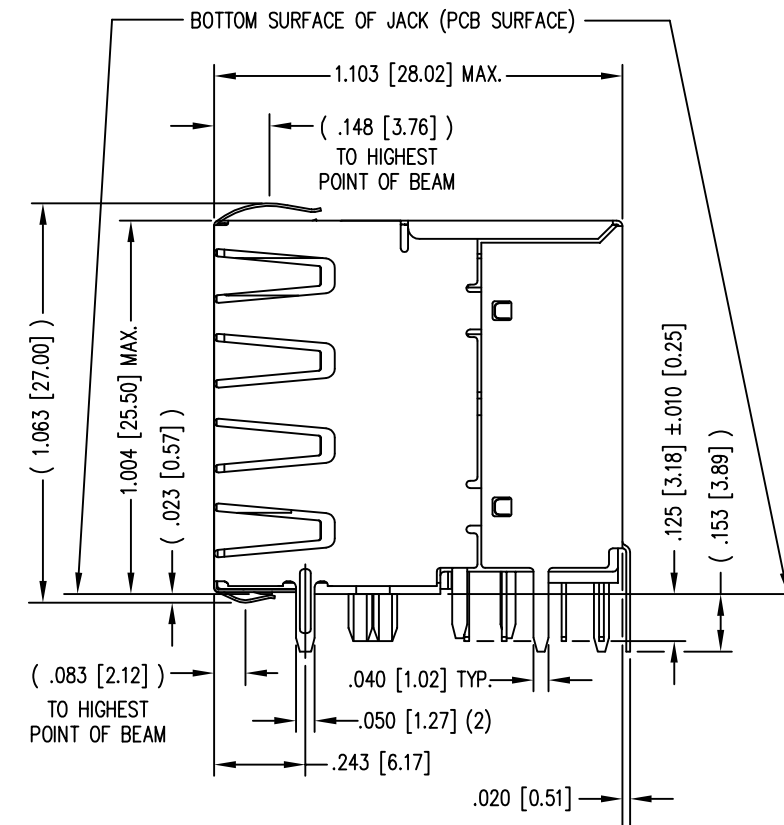
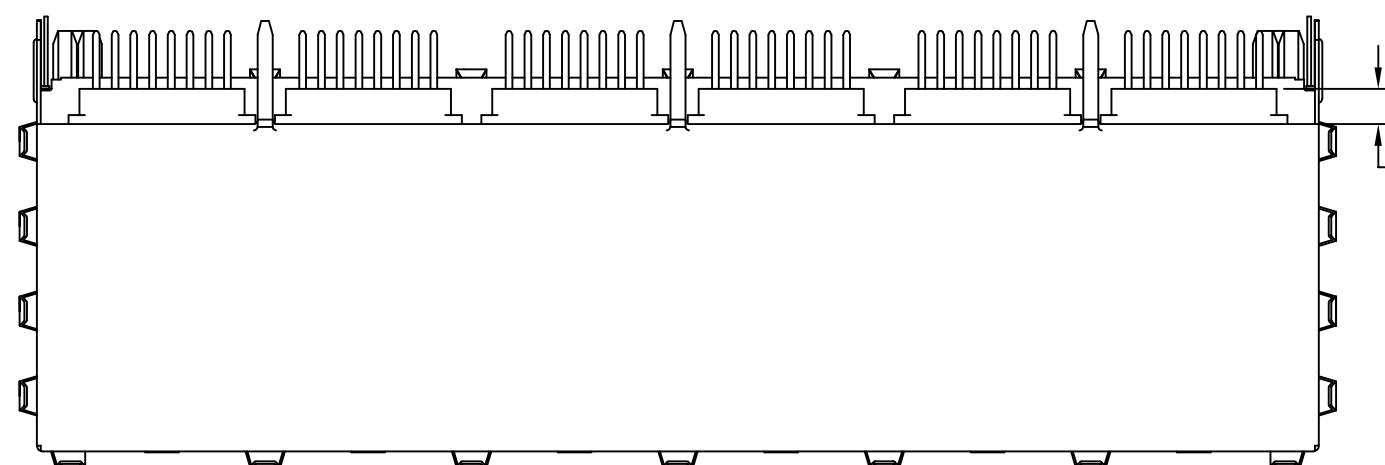
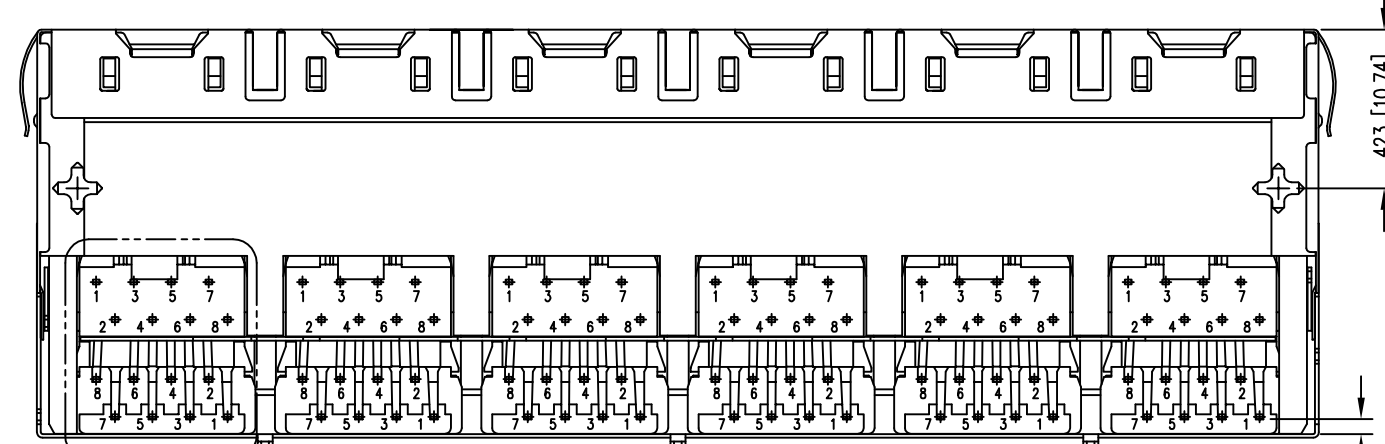
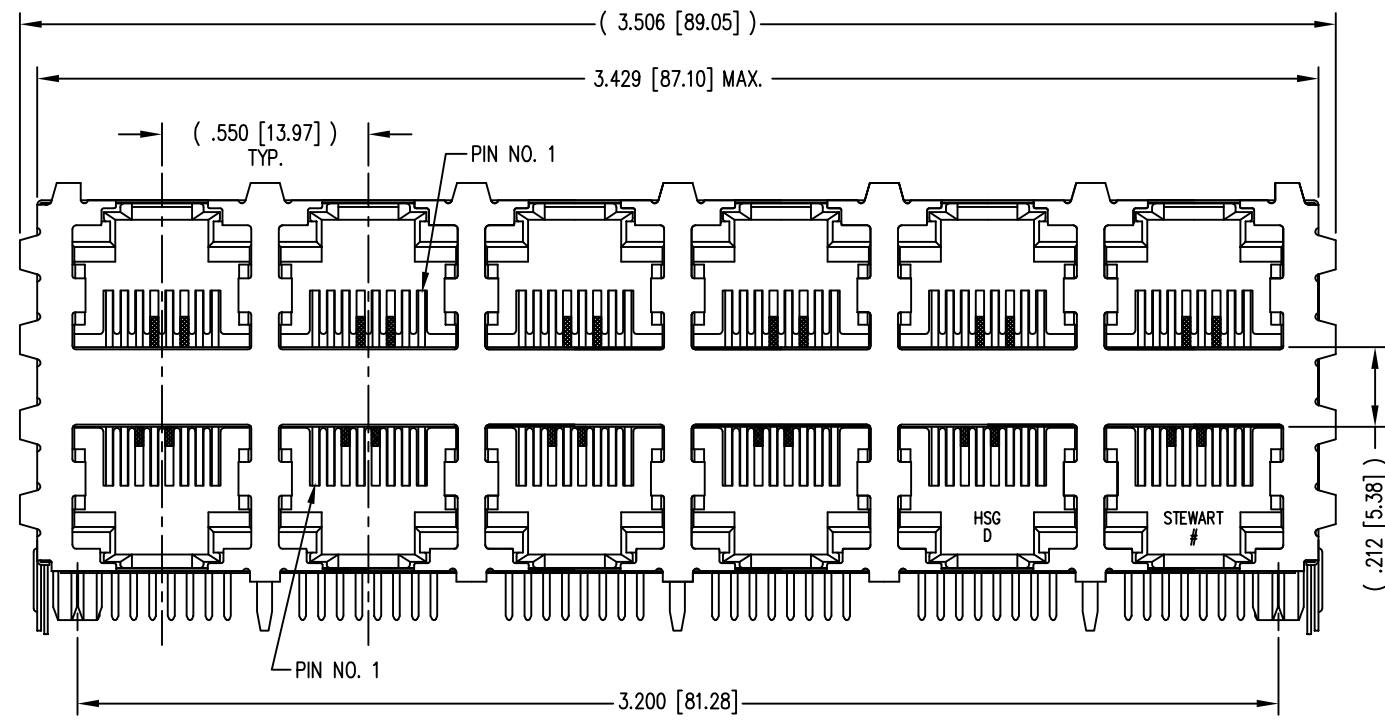
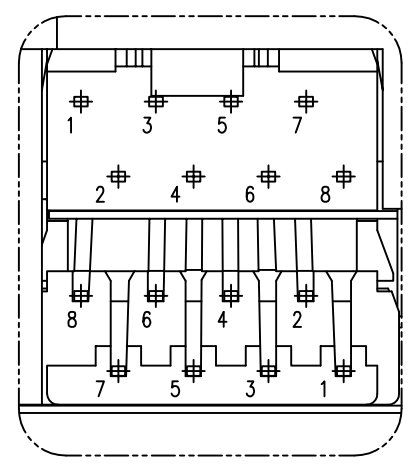

50 MICRO-INCHES [1.27um]	SS73100-046F
CONTACT PLATING IN MATING AREA	PART NUMBER

THIRD ANGLE PROJECTION

DO NOT SCALE DRAWING
DRAWING IS SUBJECT TO CHANGE WITHOUT NOTICE

DIMENSIONS: INCHES [METRIC]

UNLESS OTHERWISE SPECIFIED TOLERANCES ARE ±.005 [0.13] ANGLES ARE ± 1°

SHEET NO. 1 OF 2

1118 Susquehanna Trail South
Glen Rock, PA 17327-9199
(717) 235-7512
<http://www.stewartconnector.com>

TITLE: HIGH PERFORMANCE SHIELDED STACK JACK, 12 PORTS (6 ON 6) EIGHT CONTACT, EIGHT POSITION, 50 MICRO INCHES GOLD

THIS DRAWING AND THE SUBJECT MATTER SHOWN THEREON ARE CONFIDENTIAL AND THE PROPRIETARY PROPERTY OF STEWART CONNECTOR AND SHALL NOT BE REPRODUCED, COPIED, OR USED IN ANY MANNER WITHOUT PRIOR WRITTEN CONSENT OF STEWART CONNECTOR. ONE OR MORE U.S. PATENTS MAY APPLY TO THIS PRODUCT. FOR DETAILS, PLEASE VISIT: [HTTP://BELFUSE.COM/STEWART/STEWART_PATENTS/](http://BELFUSE.COM/STEWART/STEWART_PATENTS/)

DRN BY: TJA	DATE 9-18-08
APPD BY: TRM	DATE 9-19-08
DWG NO. CT730112F	REV. A4



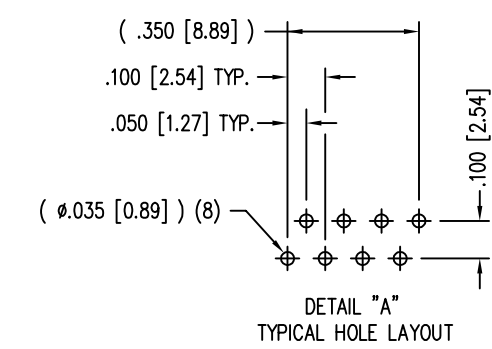
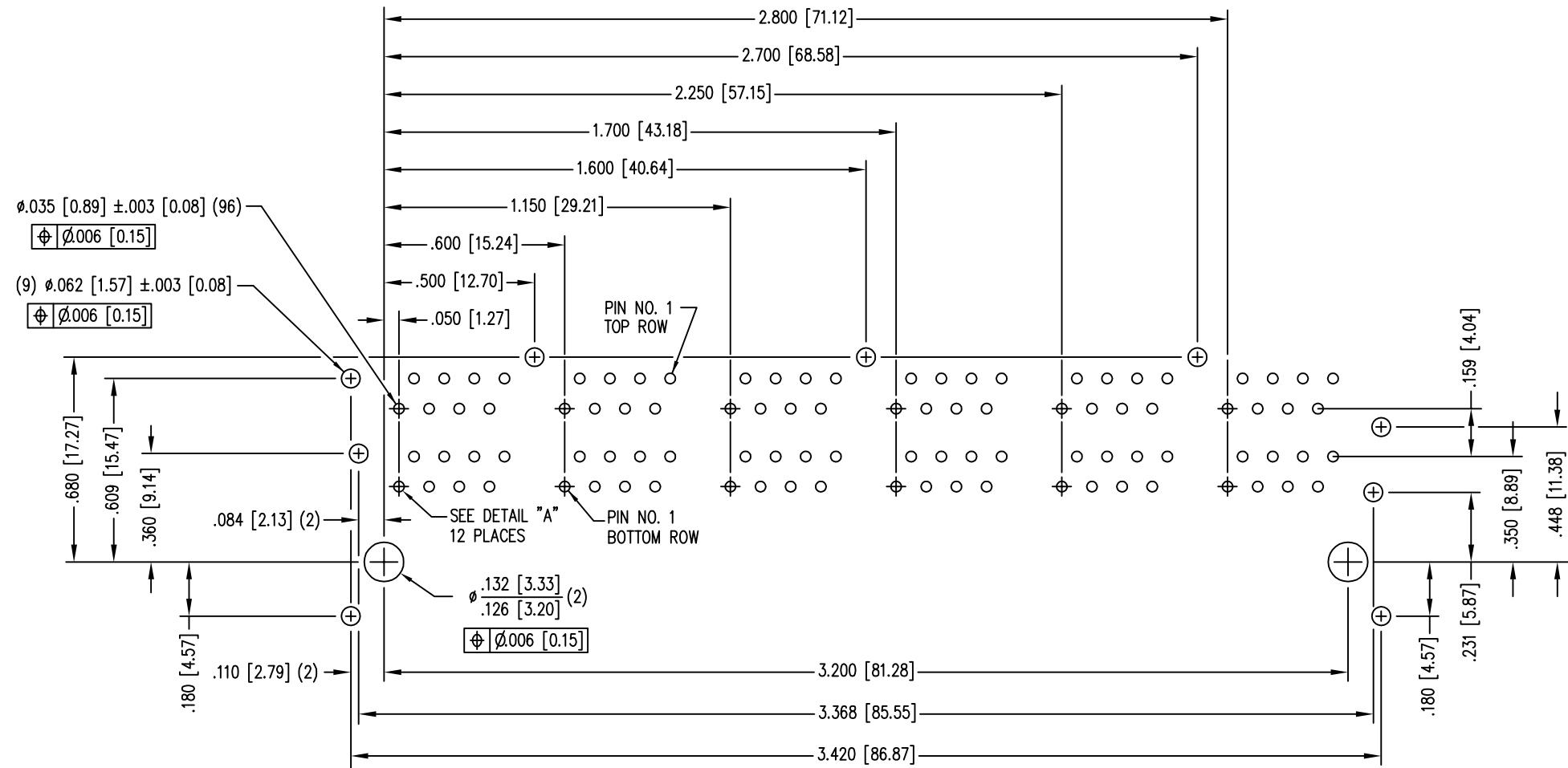

P.C.B. RECOMMENDED HOLE LAYOUT
 SEEN FROM COMPONENT SIDE
 ALL CENTERLINE DIMENSIONS ARE BASIC.

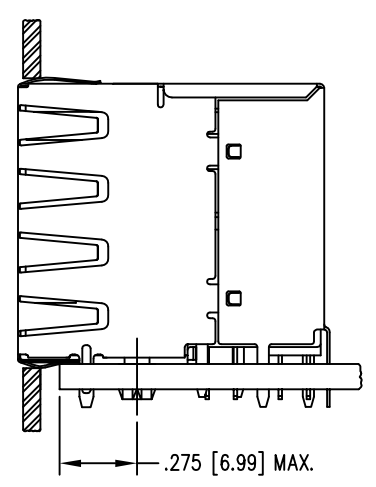
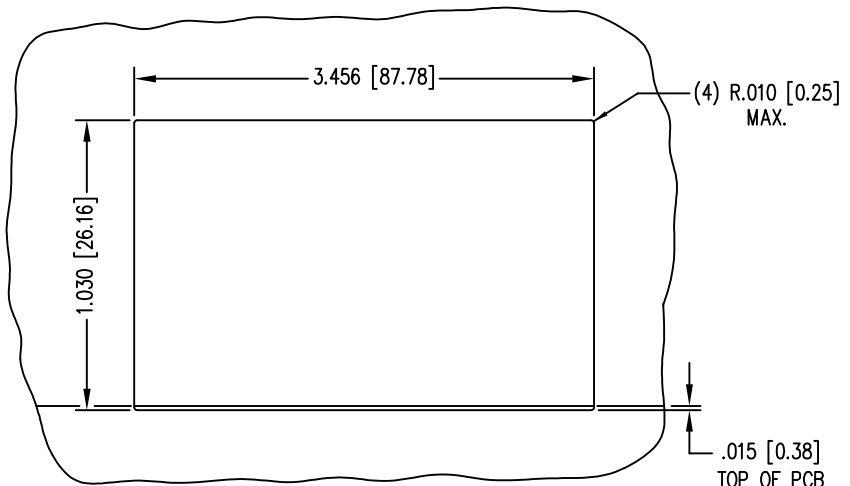

THIRD ANGLE PROJECTION 	 1118 Susquehanna Trail South Glen Rock, PA 17327-9199 (717) 235-7512 http://www.stewartconnector.com						
DO NOT SCALE DRAWING DRAWING IS SUBJECT TO CHANGE WITHOUT NOTICE	TITLE: HIGH PERFORMANCE SHIELDED STACK JACK, 12 PORTS (6 ON 6) EIGHT CONTACT, EIGHT POSITION, 50 MICRO INCHES GOLD						
DIMENSIONS: INCHES [METRIC]	THIS DRAWING AND THE SUBJECT MATTER SHOWN THEREON ARE CONFIDENTIAL AND THE PROPRIETARY PROPERTY OF STEWART CONNECTOR AND SHALL NOT BE REPRODUCED, COPIED, OR USED IN ANY MANNER WITHOUT PRIOR WRITTEN CONSENT OF STEWART CONNECTOR. ONE OR MORE U.S. PATENTS MAY APPLY TO THIS PRODUCT. FOR DETAILS, PLEASE VISIT: HTTP://BELFUSE.COM/STEWART/STEWART_PATENTS/						
SHEET NO. 2 OF 2	<table border="1"> <tr> <td>DRN BY: TJA</td> <td>DATE 9-18-08</td> </tr> <tr> <td>APPD BY: TRM</td> <td>DATE 9-19-08</td> </tr> <tr> <td>DWG NO. CT730112F</td> <td>REV. A4</td> </tr> </table>	DRN BY: TJA	DATE 9-18-08	APPD BY: TRM	DATE 9-19-08	DWG NO. CT730112F	REV. A4
DRN BY: TJA	DATE 9-18-08						
APPD BY: TRM	DATE 9-19-08						
DWG NO. CT730112F	REV. A4						