

KEMET, SSHB21HS, Commercial Grade, 3400 uH

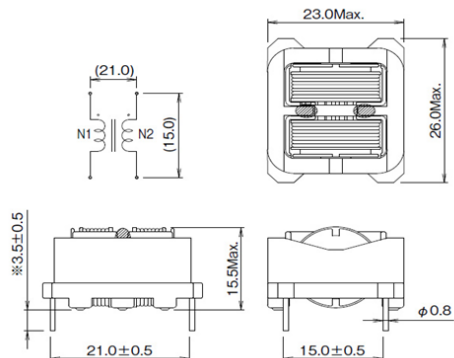

Dimensions

L	26mm MAX
T	23mm MAX
H	15.5mm MAX
S	15mm +/-0.5mm
S1	21mm NOM
LL	3.5mm +/-0.5mm
F	0.8mm NOM

Packaging Specifications

Weight:	14 g
Packaging:	Bulk
Packaging Quantity:	360

General Information

Series:	SSHB21HS
Style:	Through-Hole Choke
Description:	Common Mode Filter, SS Coils, SSHB21HS, Wide Range Impedance Type
RoHS:	Yes
Miscellaneous:	Temperature Rise Maximum: 55 K
Notes:	Marking: 20 Lot No.

Specifications

Inductance:	3.4 mH (10 kHz)
Temperature Range:	-25/+120C
Rated Temperature:	120C
Current:	2 Amps
Voltage AC:	250 VAC
Withstanding Voltage:	2400 VDC
Insulation Resistance:	100 MOhms