

HPS3000 Series

3000 Watts

Distributed Power System

Total Power: 3000 Watts
Input Voltage: 90-264 Vac
of Outputs: Single Main

Special Features

- 3000 W output power
- 40 W/cu-in
- Optional customer provided air
- 1U x 3U form factor
- N+1 Redundant
- Hot-swap
- Internal OR-ing
- 5 V housekeeping
- High efficiency 89% @ 200Vac, 100% load
- Variable speed "smart fans"
- One year warranty
- EMI Class A - EN55022, Level "A"
- EN61000 Immunity

Safety

UL/cUL: 60950
CSA: 60950
China: CCC
Nemko TUV
CB Report
CSA 22.2: 60950



Product Descriptions

The HPS3000 produces 48V of regulated output power at 62.0A and is rated for up to 3,000W of total output power at 200Vac input (1,500 W at 110Vac). The power supply features a compact 1U x 3U form factor, resulting in outstanding power density of more than 41W per cubic inch. It is designed with same-side ac inputs and dc outputs for convenience rack configuration. In addition, up to four HPS3000 units can be operated in parallel across a 1U 19 inch rack shelf to deliver 12KW of total output power. Multi-rack shelf paralleling is also supported.

The power supply offers high-efficiency (approximately 92 percent at 50 percent load) and supports a wide operating temperature range of minus 10 to plus 40 degrees Celsius. To provide the highest levels of cooling flexibility, the HPS3000 is available with or without an onboard variable speed fan, allowing customers to use alternative forced-air cooling options. The optional "smart fan" is equipped with integrated fan fail and fan speed controls to enhance overall energy efficiency. The HPS3000 is also digitally programmable and fully compatible with Emerson Network Power's PMBus™ graphical user interface software, providing customers with real-time test, monitoring and configuration functionality.

The HPS3000 is hot-swappable and features both N+1 redundancy and internal OR'ing controllers to minimize downtime and enhance overall serviceability. When used under normal operating conditions (25 degrees Celsius ambient at full load), it has a high demonstrated mean time between failures (MTBF) of more than 500,000 hours.

Model Numbers

Rev.03.13.13_#1.2
HPS3000 Series
Page 2

Standard	Output Voltage	Minimum Load	Maximum Load	Stand-By Supply	Air Flow Direction
HPS3000-9	48.0 Vdc	0A	62.5A	5V @ 3A	Normal (Handle to Connector)
HPS3000NF-9	48.0 Vdc	0A	62.5A	5V @ 3A	No Fan Version (Customer must provide external airflow through the unit)

Options

None

Electrical Specifications

Absolute Maximum Ratings

Stress in excess of those listed in the “Absolute Maximum Ratings” may cause permanent damage to the power supply. These are stress ratings only and functional operation of the unit is not implied at these or any other conditions above those given in the operational sections of this TRN. Exposure to any absolute maximum rated condition for extended periods may adversely affect the power supply’s reliability.

Table 1. Absolute Maximum Ratings:

Parameter	Model	Symbol	Min	Typ	Max	Unit
Input Voltage: AC continuous operation	All models	$V_{I,AC}$	90	-	264	Vac
Maximum Output Power (Main + Stand-by) $V_{I,AC} \leq 180Vac$ $V_{I,AC} > 180Vac$	All models	$P_{O,max}$	- -	- -	1500 3000	W W
Isolation Voltage Input to outputs Input to safety ground Outputs to safety ground	All models All models All models		- - -	- - -	2500 2500 50	Vdc Vdc Vdc
Ambient Operating Temperature	All models	T_A	-10	-	+40	°C
Storage Temperature	All models	T_{STG}	-40	-	+85	°C
Humidity (non-condensing) Operating Non-operating	All models All models		5 5	- -	95 95	% %
Altitude Operating Non-operating	All models All models		- -	- -	10,000 30,000	feet feet

Input Specifications

Rev.03.13.13 #1.2
HPS3000 Series
Page 4

Table 2. Input Specifications:

Parameter	Conditions	Symbol	Min	Typ	Max	Unit
Operating Input Voltage, AC		$V_{I,AC}$	90	115/230	264	V _{AC} _{RMS}
Input Vac Source Frequency		$f_{I,AC}$	47	50/60	63	Hz
Maximum Input Current ($I_O = I_{O,max}$, $I_{VSB} = I_{VSB,Max}$)	$V_{I,AC} = 90V_{AC}$ $V_{I,AC} = 180V_{AC}$	$I_{I,max}$	-	-	23 22	A _{RMS}
Standby Input Current (V_O Off, $I_{VSB} = 0A$)	$V_{I,AC} = 90V_{AC}$ $V_{I,AC} = 180V_{AC}$	$I_{I,standby}$	-	-	500 500	mA _{RMS}
No Load Input Current (V_O On, $I_O = 0A$, $I_{VSB} = 0A$)	$V_{I,AC} = 90V_{AC}$ $V_{I,AC} = 180V_{AC}$	I_{I,no_load}	-	-	600 600	mA _{RMS}
Harmonic Line Currents	$V_{I,AC} = 230V_{AC}$ $I_O \geq 0.5 I_{O,max}$	THD	Per IEC1000-3-2			
Power Factor	All		-	0.97	-	
Startup Surge Current (Inrush) @ 25°C	$V_{I,AC} = 264V_{AC}$		-	-	40	A _{PK}
Input Fuse	Internal, L and N 25A, 250V		-	-	25	A
Isolation – Input to Output			-	2500	-	Vdc
Isolation – Input to Chassis			-	2500	-	Vdc
Isolation – Output to Chassis			-	50	-	Vdc
Isolation – Output to Standby			-	50	-	Vdc
Leakage Current to earth ground	$V_{I,AC} = 240V_{AC}$ $f_{I,AC} = 50/60$ Hz		-	-	1.4	mA
PFC Switching Frequency	All	$f_{SW,PFC}$	75	80	85	KHz
DCDC Switching Frequency	All	$f_{SW,DC-DC}$	140	145	150	KHz
Operating Efficiency @ 25°C	$I_O = I_{O,max}$ $V_{I,AC} = 200V_{AC}$	η	89	-	-	%
System Stability: Phase Margin Gain Margin	$V_{I,AC} = 180/264V_{AC}$ $f_{I,AC} = 47/63$ Hz $I_O = 10\%$ to 100% $I_{O,max}$ max $C_o = 0,3000\mu F$		45 10	-	-	Ø dB

Output Specifications

Rev.03.13.13 #1.2
HPS3000 Series
Page 5

Table 3. Output Specifications:

Parameter		Condition	Symbol	Min	Typ	Max	Unit
Output Regulation	All models	Inclusive of set-point, temperature change, warm-up drift and dynamic load	V_O	95	-	105	% V_O
			V_{VSB}	4.8	5.0	5.2	V
Output Ripple, pk-pk	All models	Measure with a 0.1 μ F ceramic capacitor in parallel with a 10 μ F tantalum capacitor, 0 to 20MHz bandwidth	V_O	-	-	480	mV _{PK-PK}
			V_{VSB}	-	-	100	
Output Current	All models	$V_{I,AC} \leq 180Vac$ $V_{I,AC} > 180Vac$	I_O	0	-	31.25 62.50	A
			I_{VSB}	0	-	3	
V_O Current Share Accuracy		20% to 100% $I_{O,max}$		-	-	10	% $I_{O,max}$
V_O Minimum Current Share Loading				20	-	-	% $I_{O,max}$
V_O Adjust Range		Via I ² C	V_O	96	-	117	% V_O
V_O Load Capacitance (Start up)	Signal unit			-	-	3,000	μ F
	2 units in parallel			-	-	6,000	
	3 units in parallel			-	-	9,000	
	4 units in parallel			-	-	12,000	
V_{SB} Load Capacitance (Start up)				-	-	200	μ F
V_O Dynamic Response	Peak Deviation Settling Time	50% load change, slew rate = 1A/ μ s	$\pm\%V_O$	-	-	5	%
			t_s	-	-	800	μ Sec
V_O Long Term Stability Max change over 24 hours		After thermal equilibrium (30 mins)	$\pm\%V_O$			0.2	%

System Timing Specifications

Table 4. System Timing Specifications:

Label	Parameter	Min	Typ	Max	Unit
T1	Delay from AC being applied to 5Vsb being within regulation.	-	-	1500	mSec
T2	Standby rise time	-	-	5	mSec
T3	Delay from 5Vsb being in regulation to 48VDC being in regulation at AC turn on.	50	-	2000	mSec
T4	Delay from AC being applied to all output voltages being within regulation.	-	-	2000	mSec
T5	Output voltage rise time from each main output.	5	-	300	mSec
T6	Delay from output voltages within regulation limits to DCOK/PWOK# asserted at turn on.	100	-	1000	mSec
T7	Delay from loss of AC input to de-assertion of ACOK#.	10	-	-	mSec
T8	Time all output voltages, including 5Vsb, stay within regulation after loss of AC.	10	-	-	mSec
T9	Delay from loss of AC to de-assertion of DCOK/PWOK#	5	-	-	mSec
T10	Delay from DCOK/PWOK# de-asserted to 48VDC or 5VSB dropping out of regulation limits.	1	-	1000	mSec
T11	Duration of DCOK/PWOK being in the de-asserted state during an off/on cycle using AC or the PSON# signal.	100	-	-	mSec
T12	Delay from PSON# active to output voltages within regulation limits.	5	-	400	mSec
T13	Delay from PSON# de-active to DCOK/PWOK# being de-asserted.	-	-	50	mSec

System Timing Specifications

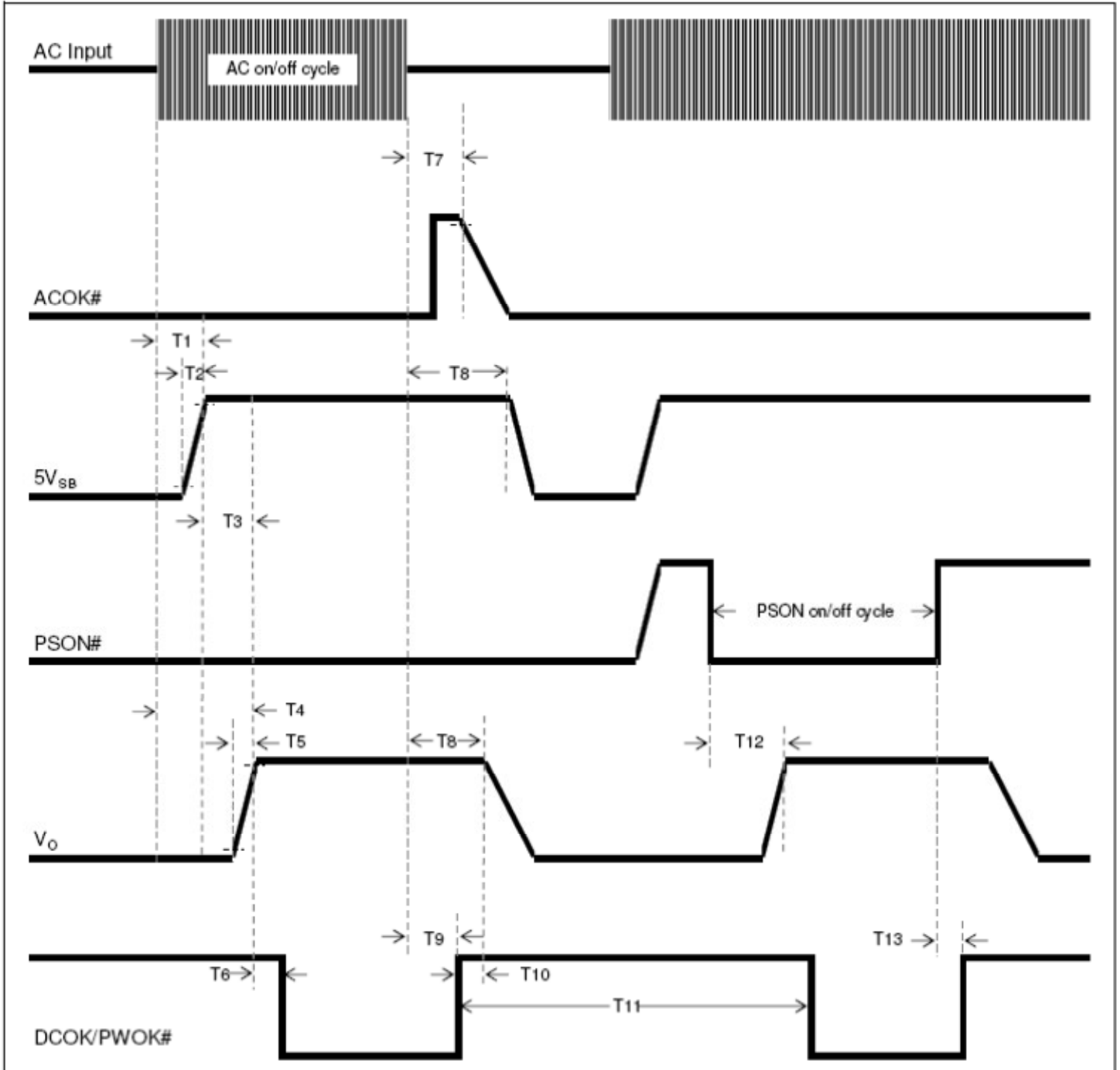

HPS3000-9 Performance Curves

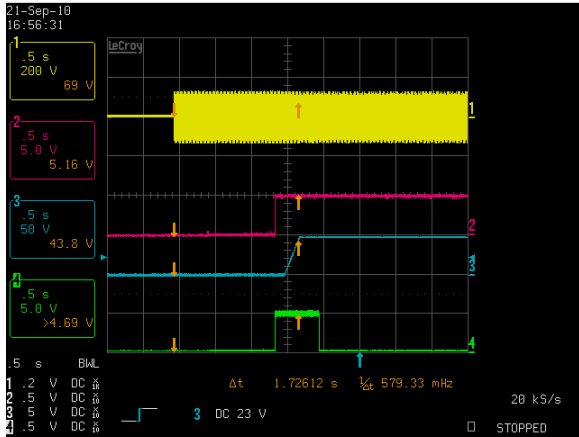

Figure 1: HPS3000-9 Turn-on delay via AC mains – Vin = 90Vac
Full load: Vo = 31.25A, VSB = 3A(5V)
Ch 1: AC Mains Ch 2: VSB Ch 3: Vo Ch 4: DCOK/PWOK#

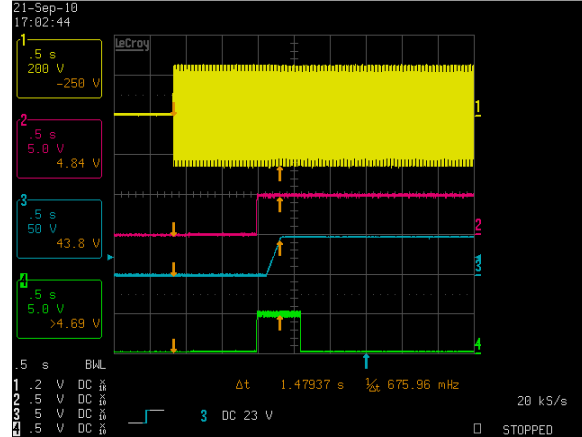

Figure 2: HPS3000-9 Turn-on delay via AC mains – Vin = 180Vac
Full load: Vo = 62.5A, VSB = 3A(5V)
Ch 1: AC Mains Ch 2: VSB Ch 3: Vo Ch 4: DCOK/PWOK#

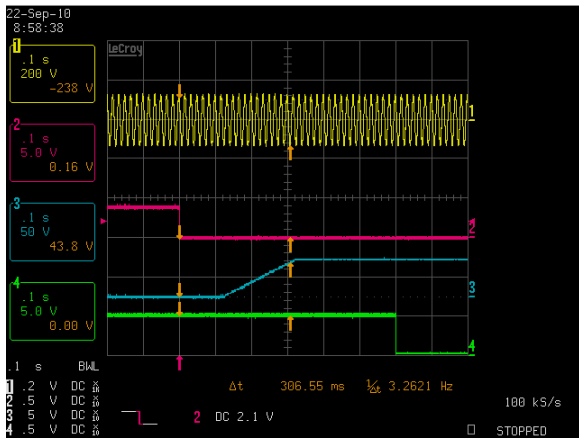

Figure 3: HPS3000-9 Turn-on delay via PSON# – Vin = 90Vac
Full load: Vo = 31.25A, VSB = 3A(5V)
Ch 1: AC Mains Ch 2: PSON# Ch 3: Vo Ch 4: DCOK/PWOK#

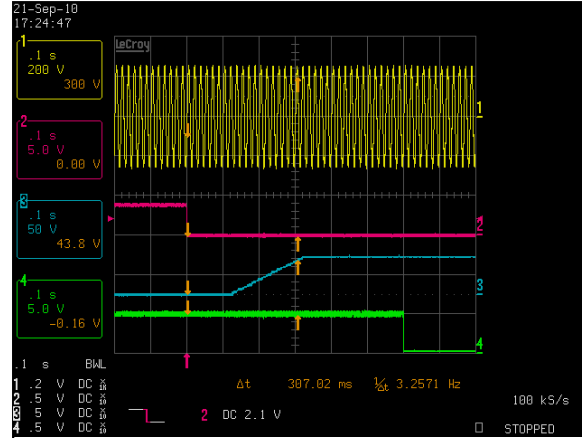

Figure 4: HPS3000-9 Turn-on delay via PSON# – Vin = 180Vac
Full load: Vo = 62.5A, VSB = 3A(5V)
Ch 1: AC Mains Ch 2: PSON# Ch 3: Vo Ch 4: DCOK/PWOK#

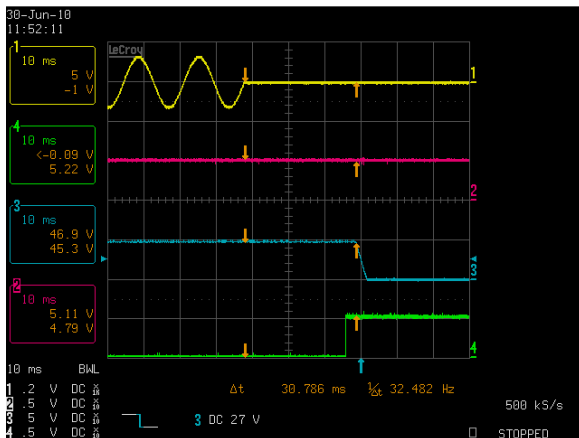

Figure 5: HPS3000-9 Hold-up Time – Vin = 90Vac / 63Hz / 0°
Full Load: Vo = 31.25A, VSB = 3A(5V)
Ch 1: AC Mains Ch 2: VSB Ch 3: Vo Ch 4: DCOK/PWOK#

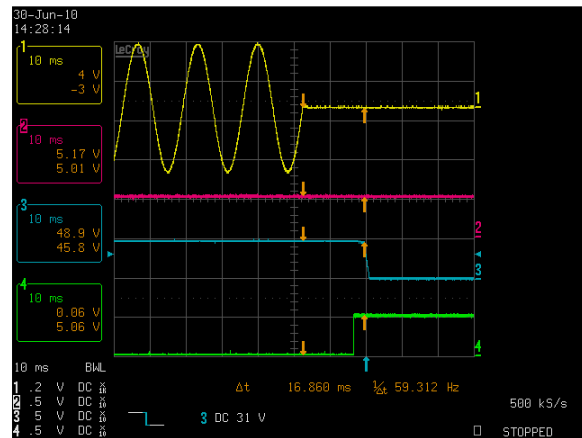

Figure 6: HPS3000-9 Hold-up time – Vin = 264Vac / 47Hz / 0°
Full Load: Vo = 62.5A, VSB = 3A(5V)
Ch 1: AC Mains Ch 2: VSB Ch 3: Vo Ch 4: DCOK/PWOK#

HPS3000-9 Performance Curves

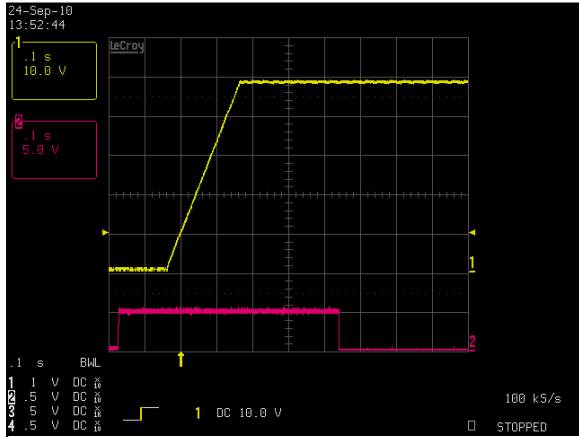

Figure 7: HPS3000-9 Output Voltage Startup Characteristic – Vin = 90Vac
Full Load: Vo = 31.25A, VSB = 3A(5V)
Ch 1: Vo
Ch 2: POWER GOOD

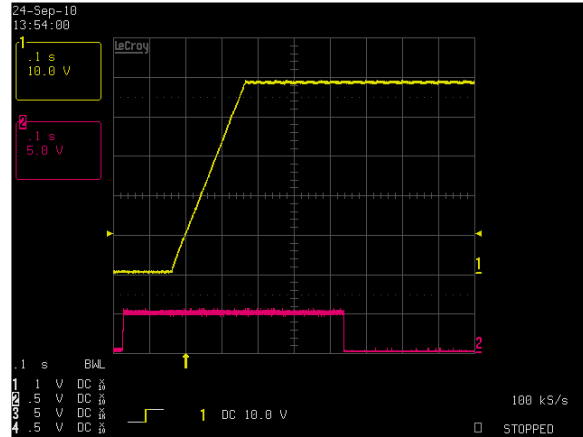

Figure 8: HPS3000-9 Output Voltage Startup Characteristic – Vin = 180Vac
Full Load: Vo = 62.5A, VSB = 3A(5V)
Ch 1: Vo
Ch 2: POWER GOOD

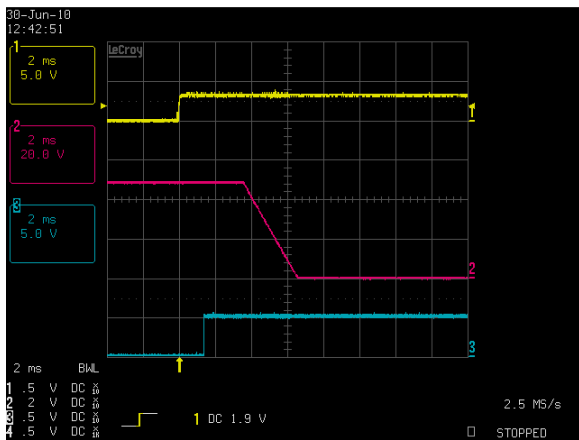

Figure 9: HPS3000-9 Turn Off Characteristic via PSON#
Full Load: Vo = 62.5A, VSB = 3A(5V)
Ch 1: PSON#
Ch 2: Vo
Ch 3: DCOK/PWOK#

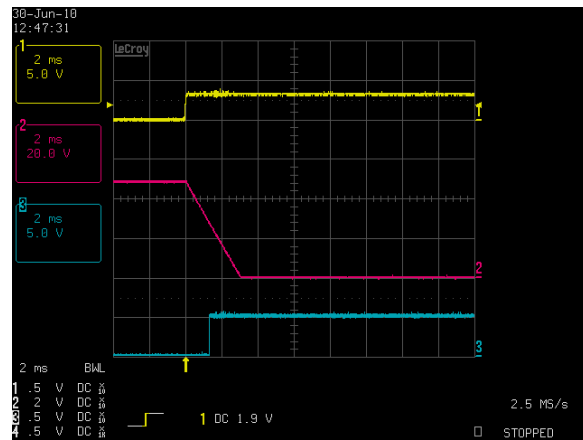

Figure 10: HPS3000-9 Turn Off Characteristic via PSKILL
Full Load: Vo = 62.5A, VSB = 3A(5V)
Ch 1: PS_INHIBIT
Ch 2: Vo
Ch 3: DCOK/PWOK#

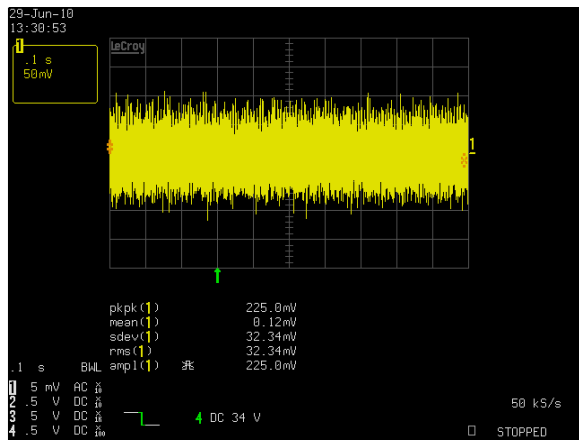

Figure 11: HPS3000-9 Ripple and Noise Measurement – Vin = 90Vac
Full Load: Vo = 31.25A, VSB = 3A(5V)
Ch 1: Vo

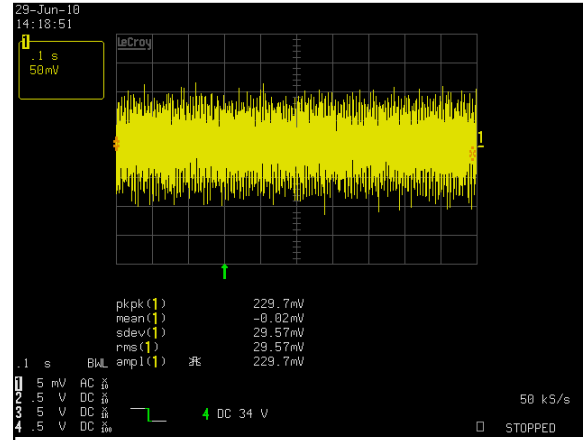

Figure 12: HPS3000-9 Ripple and Noise Measurement – Vin = 230Vac
Full Load: Vo = 62.5A, VSB = 3A(5V)
Ch 1: Vo

HPS3000-9 Performance Curves

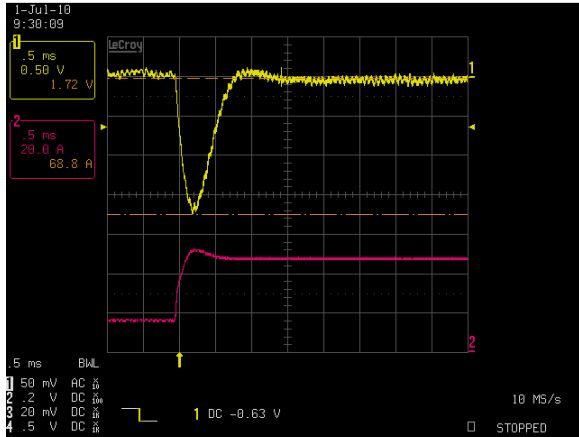

Figure 13: HPS3000-9 Transient Response – Vo Deviation (low to high)
25% to 75% load change, 1A/ μ S slew rate, Vin = 230Vac
Ch 1: Vo
Ch 2: Io

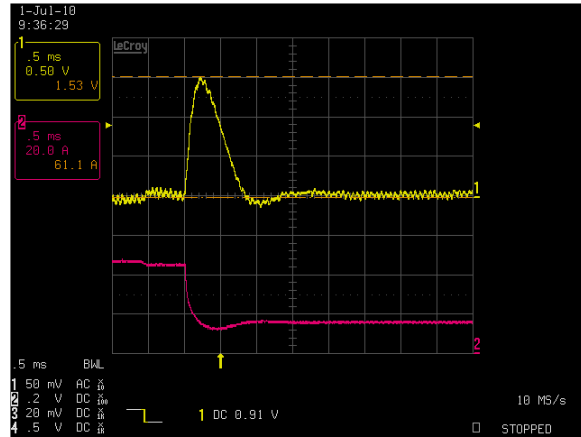

Figure 14: HPS3000-9 Transient Response – Vo Deviation (high to low)
75% to 25% load change, 1A/ μ S slew rate, Vin = 230Vac
Ch 1: Vo
Ch 2: Io

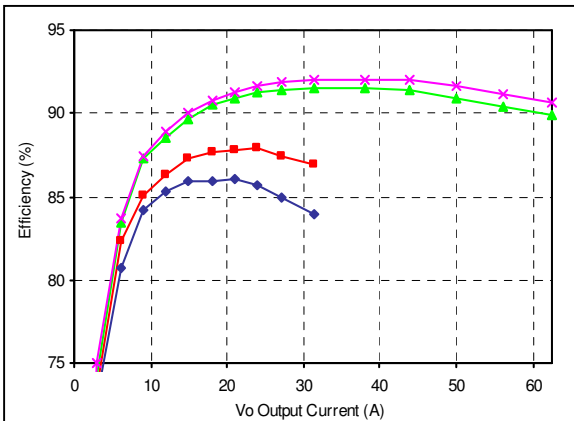

Figure 15: HPS3000-9 Efficiency Curves @ 25 degC,
—◆— 90 Vac —■— 120 Vac —▲— 230 Vac —×— 264 Vac
Loading: Vo = 10% increment to 62.5A, 5VSB = 0A,

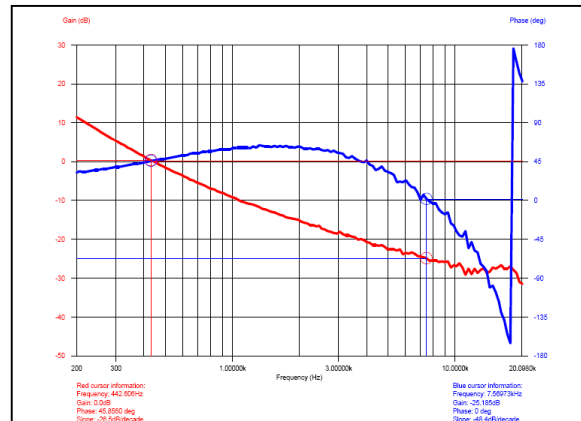

Figure 16: HPS3000-9 Gain-Phase Analysis – Vin = 180Vac
Frequency=63HZ, Load=62.19A, Capacitance Load=3000uF
Red Cursor = Gain (dB)
Blue Cursor = Phase (deg)

Protection Function Specification

Rev.03.13.13_#1.2
HPS3000 Series
Page 11

Input Fusing

HPS3000 series is equipped with an internal non user serviceable 25A High Rupturing Capacity (HRC) 250 Vac fuse to IEC 127 for fault protection in both the L1 and L2 lines input.

Over Voltage / Under Voltage Protection (OVP / UVP)

The power supply latches off during output overvoltage with the AC line or PSON# recycling to reset the latch.

OVP

Parameter	Min	Max	PMBus™ Register Value at Fault			
			0x78h	0x79h	0x7Ah	0x80h
V _O Main Overvoltage	52.8V	64V	60	8860	80	00
V _{SB} Standby Overvoltage	5.5V	6.25V	40	1840	00	48

UVP

Parameter	Min	Max	PMBus™ Register Value at Fault			
			0x78h	0x79h	0x7Ah	0x80h
V _O Main Undervoltage	41.0V	44.8V	40	8840	10	00

Over Current Protection / Short Circuit Protection (OCP/SCP)

HPS300-9 series includes internal current limit circuitry to prevent damage in the event of over current or short circuit.

OCP

Parameter	Input Voltage	Min	Nom	Max	Unit
V _O Output Overcurrent	180Vac	75.0	/	81.25	A
V _O Standby Overcurrent	180Vac	3.3	/	4.2	A

If an overload condition occurs to the 48V main output, the 48V main output will shut down and latch off. The 5V V_{SB} will remain ON. The Power LED will be solid green and the Fail LED will be blinking Amber. The PMBus™ registers will indicate the fault with the following values:

0x78h = 51
0x79h = 58 51 or 48 51
0x7Bh = A0

When the over load condition is removed, the power supply can be restarted by AC power or PSON# recycling.

If an overload condition occurs to the 5V V_{SB} output, the power supply will shut down with 48V main output turned off. The power supply (both 48V main output and 5V V_{SB}) will recover automatically when the fault condition cleared. While the fault condition exists, the Power LED will be OFF and the Fail LED will be solid Amber. The PMBus™ registers will indicate the fault with the following values:

0x78h = 40
0x79h = 18 40
0x80h = 04 or 44 or 40

SCP

If a short circuit condition occurs to the 48V main output, the 48V main output will shut down and latch off. The 5V V_{SB} will remain ON. The Power LED will be solid green and the Fail LED will be blinking Amber. The PMBus™ registers will indicate the fault with the following values:

0x78h = 40
0x79h = 18 40
0x80h = 20

When the short circuit is removed, the power supply can be restarted by AC power or PSON# recycling.

If a short circuit condition occurs to the 5V V_{SB} output, the power supply will shut down with 48V main output turned off and the 5V V_{SB} current folded back to minimum (hiccup mode). The power supply (both 48V main output and 5V V_{SB}) will recover automatically when the fault condition cleared. While the fault condition exists, the Power LED will be OFF and the Fail LED will be solid Amber. The PMBus™ registers will indicate the fault with the following values:

0x78h = 40
0x79h = 18 40
0x80h = 04 or 44 or 40

Over Temperature Protection (OTP)

The power supply is protected against over temperature conditions caused by a loss of fan cooling or excessive ambient temperature. In an OTP condition, the power supply shall be shutdown with the exception of the 5Vsb output. When the power supply temperature drops to within specified limits, the power supply shall restore the +48VDC output automatically. The OTP circuit must have built in Hysteresis such that the power supply will not oscillate on and off due to temperature recovering condition.

Mechanical Specifications

Mechanical Outlines

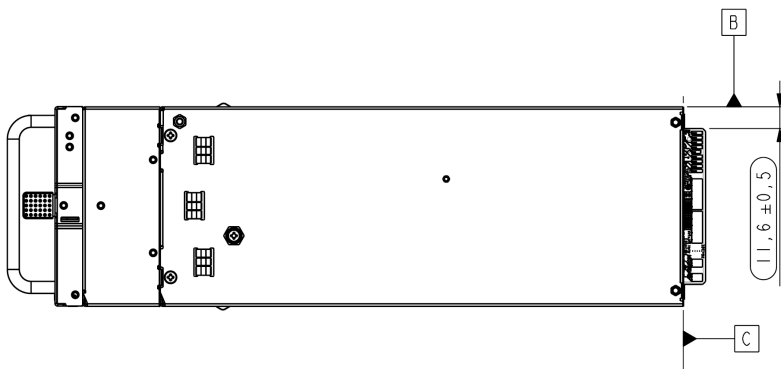
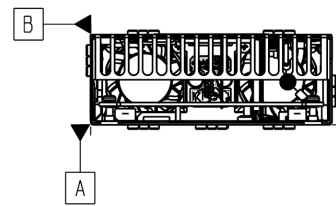
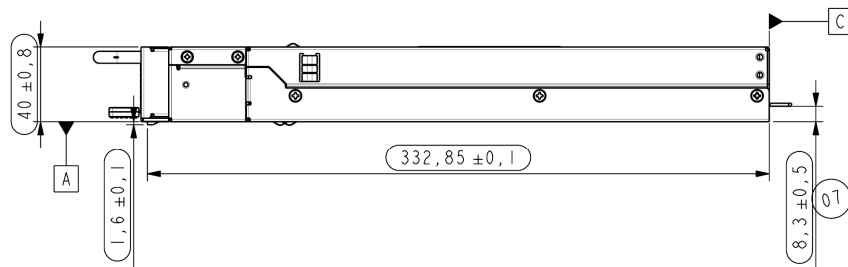
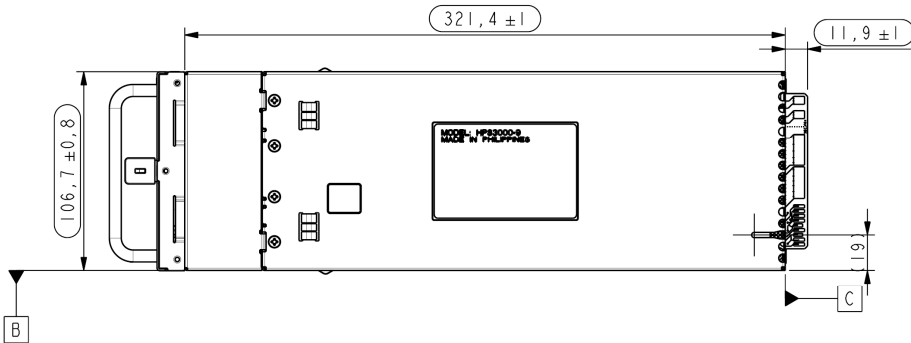
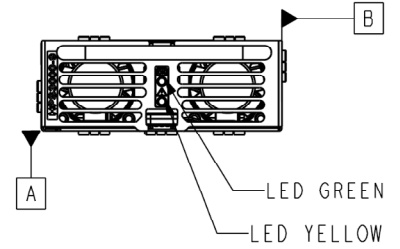
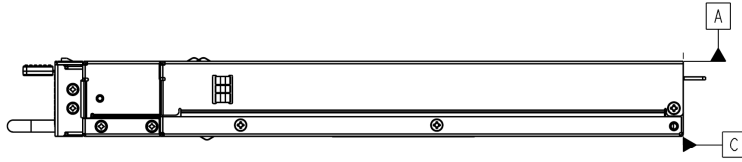

3D VIEWS

HPS3000-9

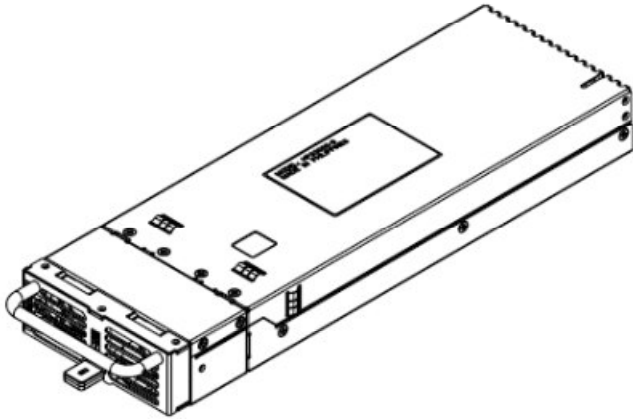

HPS3000NF-9

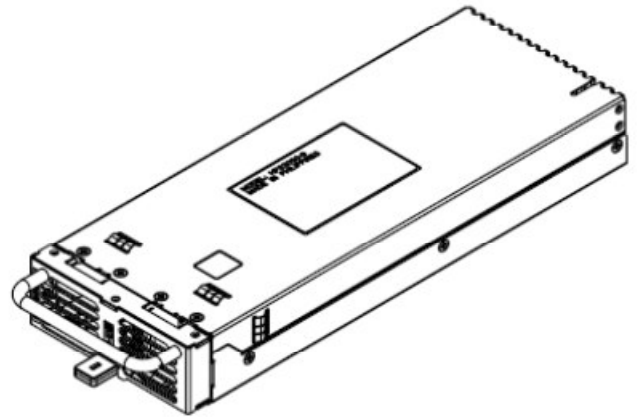

Connector Definitions

Rev.03.13.13 #1.2
HPS3000 Series
Page 15

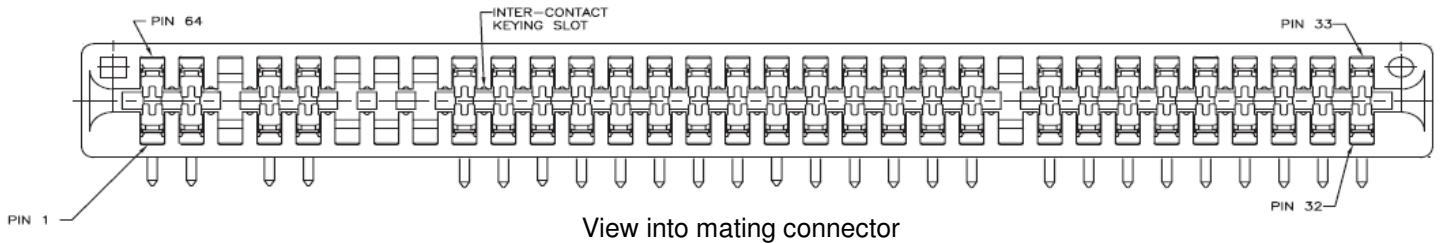

Bottom side (left to right)		Top side (left to right)	
Pin		Pin	
1	AC LINE	64	AC LINE
2	AC LINE	63	AC LINE
3	n.c.	62	n.c.
4	AC NEUTRAL	61	AC NEUTRAL
5	AC NEUTRAL	60	AC NEUTRAL
6	n.c.	59	n.c.
7	n.c.	58	n.c.
8	n.c.	57	n.c.
9	+48 Vdc out (V_O)	56	+48 Vdc out (V_O)
10	+48 Vdc out (V_O)	55	+48 Vdc out (V_O)
11	+48 Vdc out (V_O)	54	+48 Vdc out (V_O)
12	+48 Vdc out (V_O)	53	+48 Vdc out (V_O)
13	+48 Vdc out (V_O)	52	+48 Vdc out (V_O)
14	+48 Vdc out (V_O)	51	+48 Vdc out (V_O)
15	+48 Vdc out (V_O)	50	+48 Vdc out (V_O)
16	+48 Vdc RTN	49	+48 Vdc RTN
17	+48 Vdc RTN	48	+48 Vdc RTN
18	+48 Vdc RTN	47	+48 Vdc RTN
19	+48 Vdc RTN	46	+48 Vdc RTN
20	+48 Vdc RTN	45	+48 Vdc RTN
21	+48 Vdc RTN	44	+48 Vdc RTN
22	+48 Vdc RTN	43	+48 Vdc RTN
23	n.c.	42	n.c.
24	V_STBY (V_{SB})	41	STB RTN
25	Reserved	40	Reserved
26	PRESENT#	39	ACOK#
27	DCOK/PWOK#	38	SMBUS_ALERT_OUT
28	SDA	37	SCL
29	HVCC	36	A2
30	PSON#	35	PSKILL
31	#ALERT	34	A1
32	ISHARE	33	A0

Mating Connection Specifications

Rev.03.13.13_#1.2
HPS3000 Series
Page 16

Mating Connectors for HPS3000 series

Vendor	Mating Connector or Equivalent
Tyco	2007209-1
FCI	10053363-200LF

LED indicator Definition

Rev.03.13.13_#1.2
HPS3000 Series
Page 17

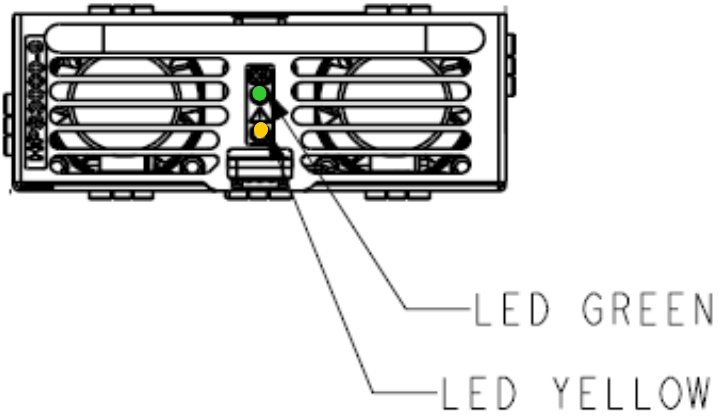

A green POWER LED (PWR) to indicate that AC is applied to the PSU and standby voltage is available when blinking. This same LED should go solid when the 48 V output is enabled and operational.

An Amber Power Supply Fail LED (FAIL) to indicate that the power supply has failed and a replacement of the unit is necessary. Faults including UVP, OVP, OTP, or Fan Fail when PSON# is asserted, "Logic Low" shall cause the amber LED to turn on. The LED can be turned off by recycling PSON# signal or by an AC power interruption more than 1 second.

The LED shall be off when PSON# is not asserted "Logic Low". Refer to below table for conditions of the LED's:

Condition	LED Conditions	
	Power LED	Fail LED
No AC power to PSU	OFF	OFF
AC present / Standby Output On	Blinking Green	OFF
Power supply DC output ON and OK	Green	OFF
Power supply failure (includes over voltage, over temperature)	OFF	Amber
Over Current Protection - Main	Green	Blinking Amber
Over Current Protection - V_{SB}	OFF	Amber



Weight

The HPS3000 series weight is 4.85 lbs (2.20kg) maximum.

Environmental Specifications

EMC Immunity

HPS3000 series power supply is designed to meet the following EMC immunity specifications:

Table 5. Environmental Specifications:

Document	Description
FCC Part 15 Subpart B	
CISPR22/EN55022	
EN61000-3-2	Harmonics
EN61000-3-3	Voltage Fluctuations
IEC/EN 61000-4-2	Electromagnetic Compatibility (EMC) - Testing and measurement techniques - Electrostatic discharge immunity test. +/-15KV air, +/-8KV contact discharge, performance Criteria B
EN 61000-4-3 Radiated Susceptibility	80 – 1000Mhz, 10V/m, AM 80% (1Khz), 900Mhz, 10V/M, PM 100% (200Hz), Criteria A
IEC/EN 61000-4-4	Electromagnetic Compatibility (EMC) - Testing and measurement techniques, Electrical Fast Transient/Burst Immunity Test. 2KV for AC power port, 1.0KV for DC ports, I/O and signal ports performance Criteria B
IEC/EN 61000-4-5	Electromagnetic Compatibility (EMC) - Testing and measurement techniques – 2KV common mode and 1KV differential mode for AC ports and 0.5kV differential mode for DC power, I/O and signal ports, performance criteria B.
IEC/EN 61000-4-11	Electromagnetic Compatibility (EMC) - Testing and measurement techniques : Voltage Dips and Interruptions: 30% reduction for 500ms-Criteria B>95% reduction for 10mS, Criteria A, >95% reduction for 5000mS, Criteria C
EN55024:1998	Information Technology Equipment-Immunity Characteristics, Limits and Method of Measurements
EN 61000-4-3 Conducted Susceptibility	0.15 – 80Mhz, 10V/m, AM 80% (1Khz), Criteria A

Safety Certifications

Rev.03.13.13 #1.2
HPS3000 Series
Page 20

The HPS3000 power supply is intended for inclusion in other equipment and the installer must ensure that it is in compliance with all the requirements of the end application. This product is only for inclusion by professional installers within other equipment and must not be operated as a stand alone product.

Table 6. Safety Certifications for HPS3000 series power supply system

Document	File #	Description
UL 60950	E186249	US and Canada Requirements
CSA 22.2 No. 60950		
EN60950		European Requirements
EN60950 Deviations (CB scheme)		International Requirements
CHINA CCC Approval	A2009CCC0907-842730	China Requirements

EMI Emissions

Rev.03.13.13 #1.2
HPS3000 Series
Page 21

The HPS3000 series has been designed to comply with the Class A limits of EMI requirements of EN55022 (FCC Part 15) and Class A limits CISPR 22 (EN55022) for emissions and relevant sections of EN61000 (IEC 61000) for immunity. The unit is enclosed inside a metal box, tested at 3000W using resistive load with cooling fan.

Conducted Emissions

The applicable standard for conducted emissions is EN55022 (FCC Part 15). Conducted noise can appear as both differential mode and common mode noise currents. Differential mode noise is measured between the two input lines, with the major components occurring at the supply fundamental switching frequency and its harmonics. Common mode noise, a contributor to both radiated emissions and input conducted emissions, is measured between the input lines and system ground and can be broadband in nature.

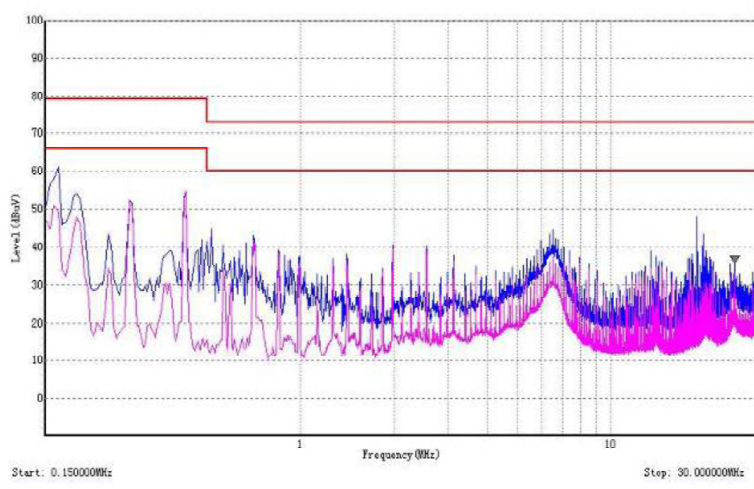

The HPS3000 power supplies have internal EMI filters to ensure the converters' conducted EMI levels comply with EN55022 (FCC Part 15) Class A and EN55022 (CISPR 22) Class A limits. The EMI measurements are performed with resistive loads at maximum rated loading.

Sample of EN55022 Conducted EMI Measurement at 100Vac input

Note: Upper Red Line refers to Emerson Quasi Peak which is 6dB below the CISPR international limit. Lower red Line refers to the Emerson Average which is 6dB below the CISPR international limit.

Table 7. Conducted EMI emission specifications of the HPS3000 series

Parameter	Model	Symbol	Min	Typ	Max	Unit
FCC Part 15, class A	All	Margin	-	-	6	dB
CISPR 22 (EN55022) class A	All	Margin	-	-	6	dB

Radiated Emissions

Rev.03.13.13_#1.2
HPS3000 Series
Page 22

Unlike conducted EMI, radiated EMI performance in a system environment may differ drastically from that in a stand-alone power supply. The shielding effect provided by the system enclosure may bring the EMI level from Class A to Class B. It is thus recommended that radiated EMI be evaluated in a system environment. The applicable standard is EN55022 Class A (FCC Part 15). Testing ac-dc convertors as a stand-alone component to the exact requirements of EN55022 can be difficult, because the standard calls for 1m leads to be attached to the input and outputs and aligned such as to maximize the disturbance. In such a set-up, it is possible to form a perfect dipole antenna that very few ac-dc convertors could pass. However, the standard also states that 'an attempt should be made to maximize the disturbance consistent with the typical application by varying the configuration of the test sample.

Operating Temperature

Rev.03.13.13_#1.2

HPS3000 Series

Page 23

The HPS3000 series power supplies will start and operate within stated specifications at an ambient temperature from -10°C to 40°C under all load conditions with internal fan.

Forced Air Cooling

The fan (s) will be included as part of the power supply assembly and provide forced air-cooling of desired CFM to maintain or control temperature of devices and ambient temperature in the power supply to appropriate levels.

Storage and Shipping Temperature / Humidity

Rev.03.13.13 #1.2
HPS3000 Series

The HPS3000 series power supplies can be stored or shipped at temperatures between -40°C to $+85^{\circ}\text{C}$ and relative humidity from 5% to 95% non-condensing.

Altitude

The HPS3000 series will operate within specifications at altitudes up to 10,000 feet above sea level. The power supply shall not be damaged when stored at altitudes of up to 30,000 feet above sea level.

Humidity

The HPS3000 series will operate within specifications when subjected to a relative humidity from 20% to 90% non-condensing. The HPS3000 series can be stored in a relative humidity from 10% to 95% non-condensing.

Vibration

The HPS3000 power supply will pass the following vibration specifications:

Non-Operating Sine Vibration

Acceleration	5	gRMS
Frequency Range	5-500	Hz
Duration	60	mins
Direction	3 mutually perpendicular axis	

Non-Operating Random Vibration

Acceleration	2.7	gRMS												
Frequency Range	10-2000	Hz												
Duration	20	mins												
Direction	3 mutually perpendicular axis													
PSD Profile	<table><thead><tr><th><u>FREQ</u></th><th><u>SLOPE</u> <u>dB/oct</u></th><th><u>PSD</u> <u>g²/Hz</u></th></tr></thead><tbody><tr><td>10-190 Hz</td><td>---</td><td>0.01 g²/Hz</td></tr><tr><td>190-210 Hz</td><td>-31.213dB/oct</td><td>---</td></tr><tr><td>210-2000 Hz</td><td>---</td><td>0.003 g²/Hz</td></tr></tbody></table>	<u>FREQ</u>	<u>SLOPE</u> <u>dB/oct</u>	<u>PSD</u> <u>g²/Hz</u>	10-190 Hz	---	0.01 g ² /Hz	190-210 Hz	-31.213dB/oct	---	210-2000 Hz	---	0.003 g ² /Hz	
<u>FREQ</u>	<u>SLOPE</u> <u>dB/oct</u>	<u>PSD</u> <u>g²/Hz</u>												
10-190 Hz	---	0.01 g ² /Hz												
190-210 Hz	-31.213dB/oct	---												
210-2000 Hz	---	0.003 g ² /Hz												

Operating Random Vibration

Rev.03.13.13_#1.2
HPS3000 Series
Page 25

Acceleration	1.0	gRMS	
Frequency Range	10-500	Hz	
Duration	20	mins	
Direction	3 mutually perpendicular axis		
PSD Profile	FREQ 10-500 Hz	SLOPE dB/oct ---	PSD g²/Hz 0.002 g ² /Hz

Shock

The HPS3000 power supply will pass the following vibration specifications:

Non-Operating Half-Sine Shock

Acceleration	30	G
Duration	18	mSec
Pulse	Half-Sine	
No. of Shock	3 shock on each of 6 faces	

Operating Half-Sine Shock

Acceleration	4	G
Duration	22	mSec
Pulse	Half-Sine	
No. of Shock	3 shock on each of 6 faces	

Power and Control Signal Descriptions

AC Input

AC Mains is supplied to the HPS3000 power supply from the following pins of the mating connector.

Pin 1, 2, 63, 64	– AC Line
Pin 4, 5, 60, 61	– AC Neutral

Main Output

These pins provide the main output for the HPS3000. The + Main Output (V_O) and the Main Output Return pins are the positive and negative rails, respectively, of the V_O main output of the HPS3000 power supply. The Main Output (V_O) is electrically isolated from the power supply chassis.

Pin 9 to 15 and Pin 50 to 56	– +48 Vdc out (V_O)
Pin 16 to 22 and Pin 43 to 49	– +48 Vdc RTN

Output Control Signals

The HPS3000 series contain 18 control signals providing analogy control interface, standby power and i²C interface.

V_STBY, V_STBY GND – (Pin 24, Pin 41)

The HPS3000 provides a regulated 5 volt 3 amp standby output voltage to power critical circuitry that must remain active regardless of the on/off status of the power supply's main output. The V_STBY (V_{SB}) voltage is available whenever a valid AC input voltage is applied to the unit. The V_STBY output (Pin 24) is referenced to the V_STBY GND pins (Pin 41).

PRESENT# – (Pin 26)

The PRESENT# signal is primarily used to provide a mechanism by which the host system can sense the number of power supplies physically present (operational or not). This signal pin is connected to Main Output Return inside the power supply. This pin is to be pull high on the system side by a resistor of 4.7K or higher. A logic LOW indicates the power supply is inserted and seated into the system power supply connector. A Logic HIGH indicated the removal of the power supply.

DCOK/PWOK# – (Pin 27)

PWOK# is a power good signal and will be pulled LOW by the power supply to indicate that both the main and standby outputs are valid. When any output voltage falls below its regulation limits or when AC power has been removed for a time sufficiently long so that power supply operation is no longer guaranteed, PWOK will be de-asserted to a HIGH state. The start of the PWOK# delay time shall be inhibited as long as the +48VDC output is in current limit or the 5Vsb output is below the regulation limit.

PWOK# Signal Characteristic		
Signal Type	Pull-up to 5Vsb through a resistor in the host system.	
PWOK# = Low	Power Good	
PWOK# = High	Power not Good	
	MIN	MAX
Logic level low voltage, sink current =4mA	0	0.4
Logic level high voltage, source current =20uA	2	5.25
Sink current, PWOK# = low	-	4mA
Source current, PWOK# = high	-	0uA
PWOK# rise and fall time		100us

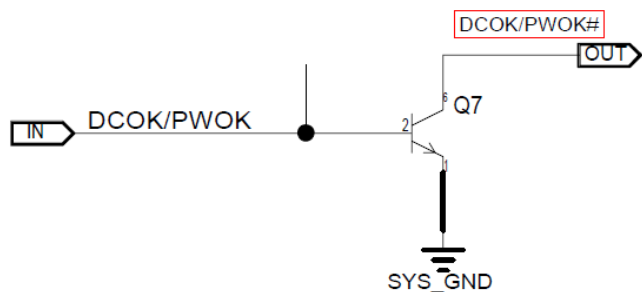

HVCC – (Pin 29)

The HVCC line should be tied together on units in parallel. This is to maintain the housekeeping power to those units that are plugged in to the system backplane but AC power is removed.

PSON# – (Pin 30)

The PSON# signal is required to remotely turn on/off the power supply. PSON# is an active low signal that turns on the +48VDC power rail when this signal is pulled low, below 0.8V. When this signal is driven higher than 2.4V, or left open circuited, the +48VDC output will be disabled (the VSB output remains on and the power supply fans operate at the lowest speed). This signal is pulled to a 3.3V standby voltage by a 4.7K ohm pull-up resistor internal to the power supply.

PSON# Signal Characteristic		
Signal Type	Pull-up to a 5Vsb voltage through a resistor internal to the power supply.	
PSON# = Low	ON	
PSON# = Open	OFF	
	MIN	MAX
Logic level low voltage (Power supply ON)	0	0.8
Logic level high voltage (Power supply OFF)	2.4	3.4
Source current, PSON# = Low	-	1mA

#ALERT – (Pin 31)

See Communication Bus Description

ISHARE – (Pin 32)

The HPS3000's main 48VDC output supports active current sharing through a single wire connection between the power supplies. This input/output signal pin allows two or more power supplies to share the main output load current to increase the overall power capability or to operate the units in a N+1 configuration for redundancy purposes. When two or more power supplies are connected and operating in parallel and each is delivering 20-100% of its rated output to the load, the power supplies will current share within 10% accuracy (Below 10% load, there is no guarantee of output current sharing). If any power supply is hot swapped, no glitch will occur that violates the regulation limits of the power supply defined in this specification.

A0, A1, A2 – (Pin 33, Pin 34, Pin 36)

Please refer to "Communication Bus Descriptions" section.

PS_KILL – (Pin 35)

This signal pin should be grounded in the system. If left open, power supply operation will be inhibited (standby VSB output will remain on).

SCL – (Pin 37)

Please refer to "Communication Bus Descriptions" section.

ACOK# – (Pin 39)

The ACOK# signal is used to indicate presence of AC input to the power supply. A logic LOW level indicate when the AC input voltage is within the allowable limits. A Logic HIGH on this signal shall indicate a loss of AC input to the power supply.

ACOK# Signal Characteristic		
Signal Type	Pull-up to 5Vsb through a resistor in the host system.	
ACOK# = Low	Present	
ACOK# = High	Not Present	
	MIN	MAX
Logic level low voltage, sink current =4mA	0	0.4
Logic level high voltage, sink current =50uA	2	5.25
Sink current, PRESENT# = Low	-	4mA
Sink current, PRESENT# = High	-	50uA

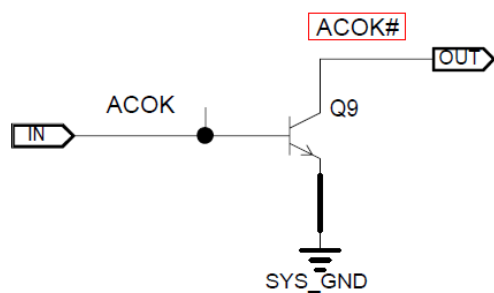

I²C Bus Signals

The HPS3000 series power supply contains enhanced monitoring and control functions implemented via the I²C bus. The hps3000 I²C functionality (PMBus™ and FRU data) can be accessed via the output connector control signals. The communication bus is powered either by the internal 5V supply or from an external power source connected to the standby output (ie: accessing an unpowered power supply as long as the standby output of another power supply connected in parallel is on).

If units are connected in parallel or in redundant mode, the standby outputs must be connected together in the system. Otherwise, the I²C bus will not work properly when a unit is inserted into the system without the AC source connected.

Note: PMBus™ functionality can be accessed only when the PSU is powered-up.
Guaranteed communication I²C speed is 100KHz.

SDA, SCL (I²C Data and Clock Signals) – (Pin 28, Pin 37)

I²C serial data and clock bus - these pins are internally pulled up to internal 5V supply with a 10K resistor. These pins must be pulled-up in the system by an 1K ohm resistor to the standby output.

#ALERT – (Pin31)

#ALERT is used to send a signal to the system that a fault in the power supply occurred. This signal is normally logic level HIGH. It will go to a LOW logic level when a fault bit has been set in the power supply's status register. To reset the #ALERT signal back to normal (logic HIGH level), perform one of the following actions - (1) recycle input AC power, (2) toggle PSON signal and (3) issuance of a CLEAR_FAULTS PMBus™ command.

A0, A1, A2 (I²C Address BIT 0, BIT1, BIT2 Signals) – (Pin 33, Pin 34, Pin36)

These two input pins are the address lines A0 and A1 to indicate the slot position the power supply occupies in the power bay and define the power supply addresses for FRU data and PMBus™ data communication. This allows the system to assign different addresses for each power supply. During I²C communication between system and power supplies, the system will be the master and power supplies will be slave. They are internally pulled up to internal 5V supply with a 5K resistor. A2 is pulled to standby output return internally in the power supply, not available as external address.

I²C Bus Communication Interval

The interval between two consecutive I²C communications to the power supply should be at least 50ms to ensure proper monitoring functionality.

I²C Bus Signal Integrity

The noise on the I²C bus (SDA, SCL lines) due to the power supply will be less than 500mV peak-to-peak. This noise measurement should be made with an oscilloscope bandwidth limited to 100MHz. Measurements should be made at the power supply output connector with 3.2K ohm resistors pulled up to standby output and 20pf ceramic capacitors to standby output return. The noise on the address lines A0 and A1 will be less than 100mV peak-to-peak. This noise measurement should be made at the power supply output connector.

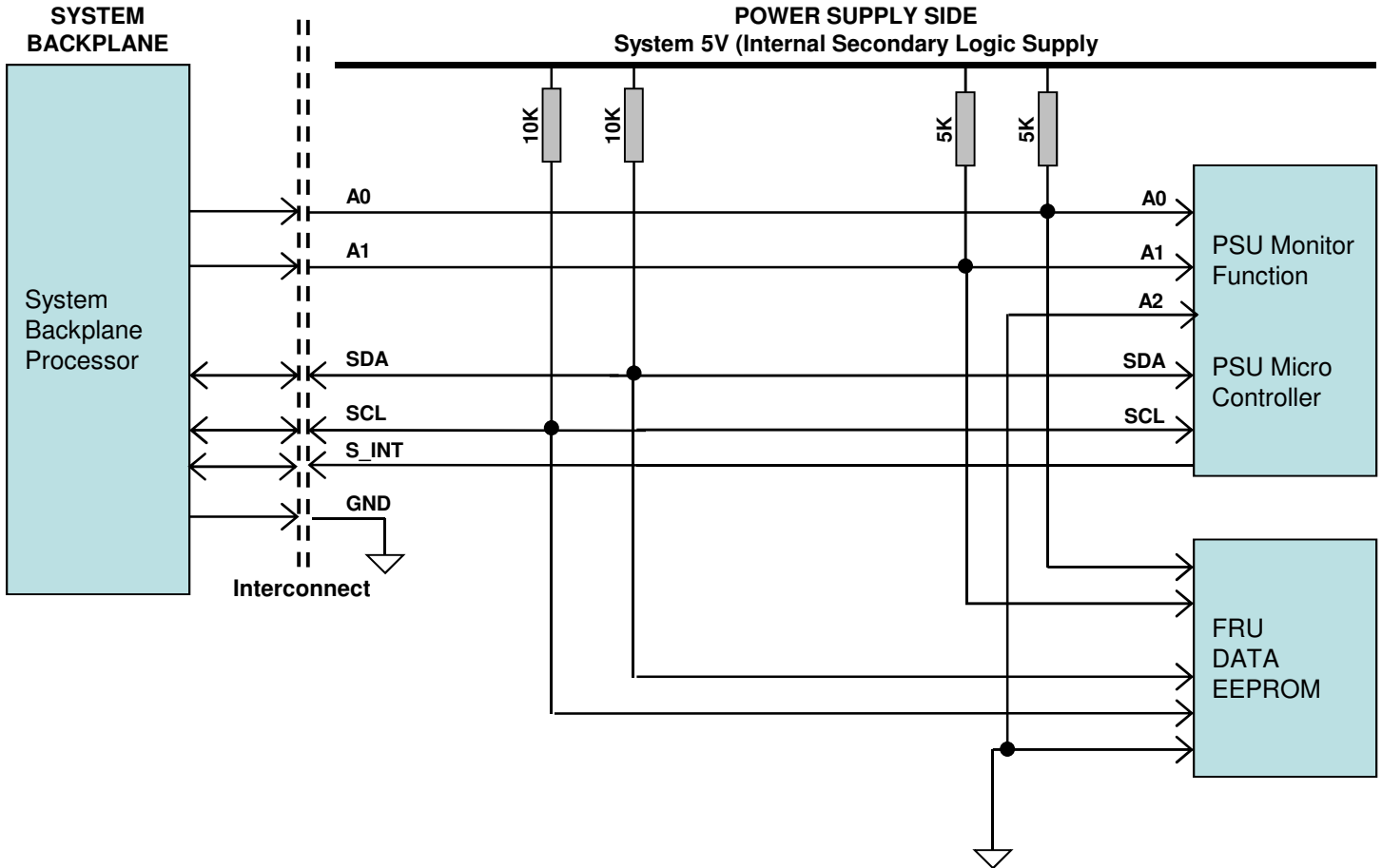

I²C Bus - Recommended external pull-ups:

Electrical and Interface specifications of I²C signals (referenced to standby output Return pin, unless otherwise indicated):

Parameter	Condition	Symbol	Min	Typ	Max	Unit
SDA, SCL internal pull-up resistor		R _{int}	-	10.0	-	Kohm
SDA, SCL internal bus capacitance		C _{int}	-	0	-	pF
Recommended external pull-up resistor 1 PSU	1 PSU	R _{ext}	-	10.0	-	Kohm
	4 PSU		-	2.5	-	Kohm

Logic Levels

HPS3000 series power supply I2C Communication Bus will respond to logic levels as per below:

Logic High: 5.1V Nominal (Specs is 2.1V to 5.5V)**

Logic Low: 500mV nominal (Specs is 800mV max)**

** Note: Philips™ I2C adapter was used.

Timings

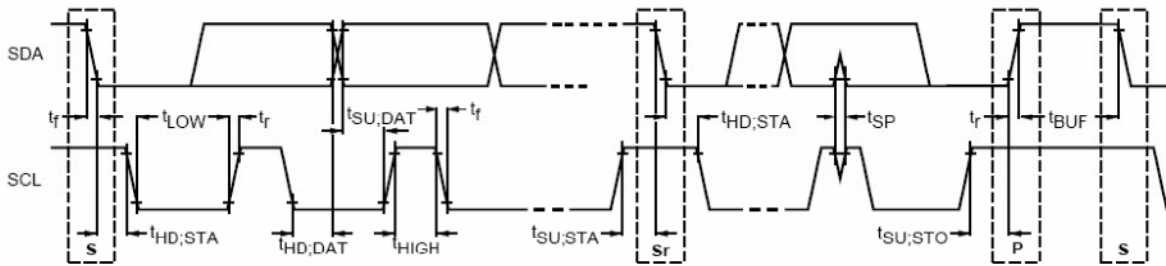

Parameter	Symbol	Standard-Mode Soecs		Actual		Unit
		Min	Max			
SCL Clock Frequency	f_{SCL}	0	100	90.1		kHz
Hold time (repeated) START condition	$t_{HD;STA}$	4.0	-	4.76		us
LOW period of SCL clock	t_{LOW}	4.7	-	4.7		us
HIGH period of SCL clock	t_{HIGH}	4.0	-	4.4		us
Setup time for repeated START condition	$t_{SU;STA}$	4.7	-	5.2		us
Data hold time	$t_{HD;DAT}$	0	3.45	1.2		us
Data setup time	$t_{SU;DAT}$	250	-	3200		ns
Rise time	t_r	-	1000	SCL = 995	SDA = 998	ns
Fall time	t_f	-	300	SCL = 160	SDA = 146	ns
Setup time for STOP condition	$t_{SU;STO}$	4.0	-	6.7		us
Bus free time between a STOP and START condition	t_{BUF}	4.7	-	20		us

*** Note Philips™ I2C adapter and bundled software (USB-to-I2C) was used

Device Addressing

The HPS3000 series will respond to supported commands on the I2C bus that are addressed according to pins A2, A1 and A0 pins of output connector.

Address pins are held HIGH by default via pulled up to internal 5V supply with a 5K resistor. To set the address as "0", the corresponding address line should be pulled down to logic ground level. Below tables show the address of the power supply with A0, A1 and A2 pins set to either "0" or "1".

The i²C address of the device is based on the slot the PSU is in. The address is defined as follows:

PSU Slot	Slot ID Bits			PMBus™ Address	EEPROM (FRU) Address
	A2	A1	A0		
1	0	0	0	0xB0	A0
2	0	0	1	0xB2	A2
3	0	1	0	0xB4	A4
4	0	1	1	0xB6**	A6

* A2 is pulled LOW internally in the power supply

* It is the default EEPROM address when A0 and A1 are left open

I²C Clock Synchronization

The HPS3000 series power supply might apply clock stretching. An addressed slave power supply may hold the clock line (SCL) low after receiving (or sending) a byte, indicating that it is not yet ready to process more data. The system master that is communicating with the power supply will attempt to raise the clock to transfer the next bit, but must verify that the clock line was actually raised. If the power supply is clock stretching, the clock line will still be low (because the connections are open-drain).

The maximum time out condition for clock stretching for HSP3000 is 100 microseconds.

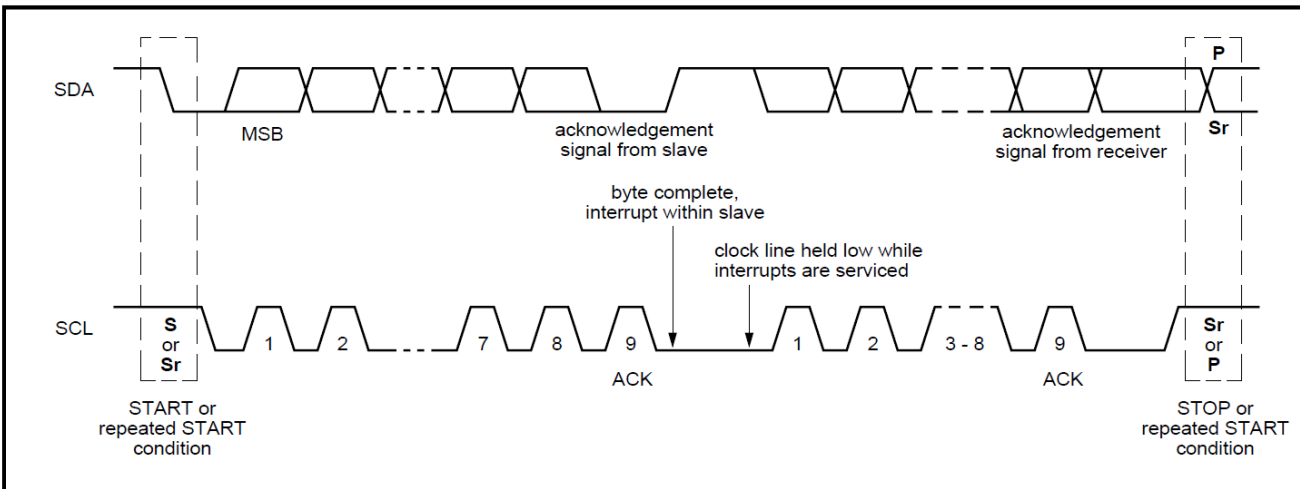

FRU (EEPROM) Data

Rev.03.13.13 #1.2
HPS3000 Series
Page 35

The FRU (Field Replaceable Unit) data format compliant with the Intel IPMI V2.1 specification.

The HPS3000 series uses 1 page of EEPROM for FRU purpose. A page of EEPROM contains up to 256 byte-sized data locations.

Where: **OFFSET** - The **OFFSET** denotes the address in decimal format of a particular data byte within HPS3000 EEPROM.

VALUE - The **VALUE** details data written to a particular memory location of the EEPROM.

DEFINITION - The contents **DEFINITION** refers to the definition of a particular data byte.

HPS3000-9 FRU (EEPROM) Data:

OFFSET		DEFINITION (REMARKS)	SPEC VALUE	
(DEC)	(HEX)		(DEC)	(HEX)
COMMON HEADER, 8 BYTES				
0	00	FORMAT VERSION NUMBER (Common Header)	1	01
1	01	INTERNAL USE AREA OFFSET (In multiples of 8 Bytes)	24	18
2	02	CHASSIS INFO AREA OFFSET (In multiples of 8 Bytes)	1	01
3	03	BOARD INFO AREA OFFSET (No Used)	0	00
4	04	PRODUCT INFO AREA OFFSET (In multiples of 8 Bytes)	5	05
5	05	MULTI RECORD AREA OFFSET (In multiples of 8 Bytes)	15	0F
6	06	PAD (reserved always 00H)	0	00
7	07	ZERO CHECK SUM (256 – (Sum of bytes 000d to 006d))	210	D2
COMPUTER/CHASSIS INFO AREA(32 BYTES)				
8	08	FORMAT VERSION NUMBER (Default is 1.)	1	01
9	09	CHASSIS INFO AREA LENGTH (Default is 0.)	0	00
10	0A	CHASSIS TYPE (Default value is 0.)	0	00
11	0B	Chassis Part Number Type/Length 10 Bytes allocation	0	00
12	0C	CHASSIS PART NUMBER BYTES (Default value is 0.)	0	00
13	0D		0	00
14	0E		0	00
15	0F		0	00
16	10		0	00
17	11		0	00
18	12		0	00
19	13		0	00
20	14		0	00
21	15		0	00
22	16	Chassis Part Number Type/Length 15 Bytes allocation 0CFH (if used) (Default value is 0.)	0	00
23	17	CHASSIS SERIAL NUMBER (Default value is 0.)	0	00
24	18		0	00
25	19		0	00
26	1A		0	00
27	1B		0	00
28	1C		0	00
29	1D		0	00
30	1E		0	00
31	1F		0	00
32	20		0	00
33	21		0	00
34	22		0	00
35	23		0	00
36	24		0	00
37	25		0	00

HPS3000-9 FRU (EEPROM) Data:

Rev.03.13.13 #1.2
HPS3000 Series
Page 36

OFFSET		DEFINITION	SPEC VALUE	
(DEC)	(HEX)	(REMARKS)	(DEC)	(HEX)
38	26	End Tag (0C1h if used) (Default value is 0.)	0	00
39	27	ZERO CHECK SUM (From 08d to 38d if used)	255	FF
COMPUTER/CHASSIS INFO AREA(32 BYTES)				
40	28	FORMAT VERSION NUMBER	1	01
41	29	PRODUCT INFO AREA LENGTH (In multiples of 8 bytes) 80 Bytes are allocated. 80-Bytes / 8 = 0AH.	10	0A
42	2A	Language (English=19H)	25	19
43	2B	MANUFACTURER NAME TYPE / LENGTH (0C5H) 7-6: (11)b, 8-Bit ASCII + Latin 1, 5-0: (000101)b, 5-Byte Allocation	197	C5
44	2C	MANUFACTURER'S NAME 5 byte sequence "E" "N" "P"	69	45
45	2D		78	4E
46	2E		80	50
47	2F		32	20
48	30		32	20
49	31	PRODUCT NAME Type/Length (0CEH) 7-6: (11)b, 8-Bit ASCII + Latin 1, 5-0: (001110)b, 14-Byte Allocation	206	CE
50	32	PRODUCT NAME "H" "P" "S" "3" "0" "0" "0" "0" "0" "0" "0" "0" "0"	72	48
51	33		80	50
52	34		83	53
53	35		51	33
54	36		48	30
55	37		48	30
56	38		48	30
57	39		45	2D
58	3A		57	39
59	3B		000	00
60	3C		000	00
61	3D		000	00
62	3E		000	00
63	3F		000	00
64	40	PART/MODEL NUMBER Type/Length (0CAH) 7-6: (11)b, 8-Bit ASCII + Latin 1, 5-0: (001000)b, 8-Byte Allocation	200	C8
65	41	Power Supply Spare Kit Number NOT APPLICABLE	000	00
66	42		000	00
67	43		000	00
68	44		000	00
69	45		000	00
70	46		000	00
71	47		000	00
72	48		000	00
73	49	Product Version Number Type/Length (0C2H) 7-6: (11)b, 8-Bit ASCII + Latin 1, 5-0: (000010)b, 2-Byte Allocation	194	C2
74	4A	Product Version Number / Auto Rev *SHOULD TRACK MODEL REVISION on IPS Sec. 1.2	XXX	XX
75	4B		XXX	XX
76	4C	Product Serial Number Type/Length (0CDH) *PRODUCT SERIAL NUMBER IS BASED ON ASTEC SERIAL NUMBER FORMAT P/N: 417-00201000 7-6: (11)b, 8-Bit ASCII + Latin 1, 5-0: (001101)b, 13-Byte Allocation	205	CD

HPS3000-9 FRU (EEPROM) Data:

OFFSET		DEFINITION	SPEC VALUE	
(DEC)	(HEX)	(REMARKS)	(DEC)	(HEX)
77	4D	Product Serial Number: MODEL ID "H" "0" "8" "1"	72	48
78	4E		48	30
79	4F		56	38
80	50		49	31
81	51	MANUFACTURING YEAR AND WEEK CODE Product Serial Number: MANUFACTURING YEAR AND WEEK CODE *REFER TO 417-00201000 FOR DETAILS	XXX	XX
82	52		XXX	XX
83	53	Product Serial Number: UNIQUE SERIAL NUMBER *REFER TO 417-00201000 FOR DETAILS	XXX	XX
84	54		XXX	XX
85	55		XXX	XX
86	56		XXX	XX
87	57	Product Serial Number: MODEL REVISION *SHOULD TRACK MODEL REVISION on IPS Sec. 1.2	XXX	XX
88	58		XXX	XX
Product Serial Number: MANUFACTURING LOCATION *REFER TO 417-00201000 FOR DETAILS				
89	59	"P" (P for Laguna Philippines)	80	50
90	5A	ASSET TAG 7-6: (11)b, 8-Bit ASCII + Latin 1, 5-0: (001000)b, 8-Byte Allocation	200	C8
91	5B	NO ASSET TAG	000	00
92	5C		000	00
93	5D		000	00
94	5E		000	00
95	5F		000	00
96	60		000	00
97	61		000	00
98	62		000	00
99	63	FRU File ID 7-6: (11)b, 8-Bit ASCII + Latin 1, 5-0: (010001)b, 17-Byte Allocation	209	D1
100	64	"Should track latest EEPROM Revision on IPS Sec. 1.2" NOT APPLICABLE		00
101	65		000	00
102	66		000	00
103	67		000	00
104	68		000	00
105	69		000	00
106	6A		000	00
107	6B		000	00
108	6C		000	00
109	6D		000	00
110	6E		000	00
111	6F		000	00
112	70		000	00
113	71		000	00
114	72		000	00
115	73		000	00
116	74		000	00
117	75	End of Fields Marker	193	C1
118	76	RESERVED	000	00
119	77	Zero Checksum From 040d to 118d	XXX	XX

HPS3000-9 FRU (EEPROM) Data:

Rev.03.13.13 #1.2
HPS3000 Series
Page 38

OFFSET		DEFINITION	SPEC VALUE	
(DEC)	(HEX)	(REMARKS)	(DEC)	(HEX)
MULTI RECORD AREA : Power Supply Information 72 Bytes				
Power Supply Record Header				
120	78	Record Type ID (0x00 = Power Supply Information)	000	00
121	79	7: (0)b, End of List 6-4: (000)b, Reserved 3-0: (0010)b, Record Format Version	002	02
122	7A	Record Length: 24 Bytes	24	18
123	7B	Record Checksum (Zero Checksum From 125d To 148d)	100	64
124	7C	Header Checksum (Zero Checksum From 120d To 123d)	13	82
Power Supply Record				
125	7D	Overall Capacity (Watts)	184	B8
126	7E	15-12: (0000)b, Reserved 11-0: (11111010000)b, 3000W Stored with LSB first then MSB.	011	0B
127	7F	Peak VA (Watts)	000	00
128	80	15-12: (0000)b, Reserved 11-0: No peak VA rating Stored with LSB first then MSB	000	00
129	81	Inrush Current (Amps) 40Amps	40	28
130	82	Inrush Interval (ms) 0ms	000	00
131	83	Low End Input Voltage Range 1	000	00
132	84		000	00
133	85	High End Input Voltage Range 1	000	00
134	86		000	00
135	87	Low End Input Voltage Range 2	80	50
136	88	180V = 18000 (x10mV) Stored with LSB first then MSB.	70	46
137	89	High End Input Voltage Range 2	32	20
138	8A	264V = 26400 (x10mV) Stored with LSB first then MSB.	103	67
139	8B	Low End Input Frequency Range, 47Hz	47	2F
140	8C	High End Input Frequency Range, 63Hz	63	3F
141	8D	A/C Dropout Tolerance in ms, 12ms	12	0C
142	8E	Binary Flags 7-5: (000)b, Reserved 4: (1)b, Tachometer Pulses per Rotation / Predictive Fail Polarity (2 Pulses Per Rotation = 1; 1 Pulse Per Rotation = 0) OR (Signal Asserted(1) Indicates Failure = 0, Signal Deasserted(0) Indicates Failure = 1) 3: (1)b, Hot Swap / Redundancy Support 2: (0)b, AutoSwitch Support 1: (1)b, Power Factor Correction Support 0: (0)b, Predictive Fail Support	26	1A
143	8F	Peak Wattage Capacity and Holdup Time	000	00
144	90	15-12: (0000)b, Hold Up Time in Seconds = 00H (Not Specified) 11-0: (000000000000)b, Peak Capacity in Watts = 00H (Not Specified)	000	00
145	91	Combined Wattage	000	00
146	92	NOT APPLICABLE	000	00
147	93		000	00
148	94	Predictive Fail Tachometer Lower Threshold, Not applicable	000	00

HPS3000-9 FRU (EEPROM) Data:

Rev.03.13.13 #1.2
HPS3000 Series
Page 39

OFFSET		DEFINITION	SPEC VALUE	
(DEC)	(HEX)	(REMARKS)	(DEC)	(HEX)
48V DC Output Record Header				
149	95	Record Type ID (0x01 = DC Output)	001	01
150	96	End Of List/Record Format Version Number 7: (0)b, End of List 6-4: (000)b, Reserved 3-0: (0010)b, Record Format Version	002	02
151	97	Record Length: 13 Bytes	013	0D
152	98	Record Checksum (Zero Checksum From 154d To 166d)	194	C2
153	99	Header Checksum (Zero Checksum From 149d To 152d)	46	2E
+48V DC Output Record				
154	9A	48V Output Information 7: (0)b, Standby 6-4: (000)b, Reserved 3-0: (0001)b, Output Number 1	001	01
155	9B	Nominal Voltage 48V = 4800 (x10mV) Stored with LSB first then MSB.	192	C0
156	9C		018	12
157	9D	Maximum Negative Voltage Deviation 43.2V = 4320 (x10mV) Stored with LSB first then MSB.	224	E0
158	9E		016	10
159	9F	Maximum Positive Voltage Deviation 52.8V = 5280(x10mV) Stored with LSB first then MSB.	160	A0
160	A0		020	14
161	A1	Ripple And Noise pk -pk 10Hz To 30MHz (mV) 480mV Stored with LSB first then MSB.	224	E0
162	A2		001	01
163	A3	Minimum Current Draw (10mA) 1A = 100 (x10mA) Stored with LSB first then MSB.	100	64
164	A4		000	00
165	A5	Maximum Current Draw (10mA) 62.50A = 6250 (x10mA) Stored with LSB first then MSB.	106	6A
166	A6		024	18
5VSB DC Output Record Header				
167	A7	Record Type ID (0x01 = DC Output)	001	01
168	A8	End Of List/Record Format Version Number 7: (1)b, End of List 6-4: (000)b, Reserved 3-0: (0010)b, Record Format Version	130	82
169	A9	Record Length: 20 Bytes	020	14
170	AA	Record Checksum (Zero Checksum From 172d To 191d)	219	DB
171	AB	Header Checksum (Zero Checksum From 167d To 170d)	142	8E
5V SB DC Output Record				
172	AC	5VSB Output Information 7: (1)b, Standby (Bit = 1 to indicate standby output) 6-4: (000)b, Reserved 3-0: (0010)b, Output Number 2 = 010b	130	82
173	AD	Nominal Voltage 5V = 500 (x10mV) Stored with LSB first then MSB.	244	F4
174	AE		001	01

HPS3000-9 FRU (EEPROM) Data:

Rev.03.13.13 #1.2
HPS3000 Series
Page 40

OFFSET		DEFINITION	SPEC VALUE	
(DEC)	(HEX)	(REMARKS)	(DEC)	(HEX)
175	AF	Maximum Negative Voltage Deviation 4.8V = 480 (x10mV) Stored with LSB first then MSB.	224	E0
176	B0		001	01
177	B1	Maximum Positive Voltage Deviation 5.2V = 520 (x10mV) Stored with LSB first then MSB.	008	08
178	B2		002	02
179	B3	Ripple And Noise pk -pk 10Hz To 30MHz (mV) 100mV Stored with LSB first then MSB.	100	64
180	B4		000	00
181	B5	Minimum Current Draw (10mA) 0.5A = 50(x 10mA) Stored with LSB first then MSB.	050	32
182	B6		000	00
183	B7	Maximum Current Draw (10mA) 3.00A = 300(x 10mA) Stored with LSB first then MSB.	044	2C
184	B8		001	01
185	B9	Reserved	000	00
186	BA	Reserved	000	00
187	BB	Reserved	000	00
188	BC	Reserved	000	00
189	BD	Reserved	000	00
190	BE	Reserved	000	00
191	BF	Reserved	000	00
INTERNATIONAL USE AREA, 64 BYTES				
192	C0	Format Version Number 7:4 -reserved, write as 0000b 3:0 -format version number = 1h for this specification.	001	01
193	C1		0	00
194	C2		0	00
195	C3		0	00
196	C4		0	00
197	C5		0	00
198	C6		0	00
199	C7		0	00
200	C8		0	00
201	C9		0	00
202	CA		0	00
203	CB		0	00
204	CC		0	00
205	CD		0	00
206	CE		0	00
207	CF		0	00
208	D0		0	00
209	D1		0	00
210	D2		0	00
211	D3		0	00
212	D4		0	00
213	D5		0	00
214	D6		0	00
215	D7		0	00
216	D8		0	00
217	D9		0	00
218	DA		0	00
219	DB		0	00
220	DC		0	00

HPS3000-9 FRU (EEPROM) Data:

OFFSET		DEFINITION (REMARKS)	SPEC VALUE	
(DEC)	(HEX)		(DEC)	(HEX)
221	DD		0	00
222	DE		0	00
223	DF		0	00
224	E0		0	00
225	E1		0	00
226	E2		0	00
227	E3		0	00
228	E4		0	00
229	E5		0	00
230	E6		0	00
231	E7		0	00
232	E8		0	00
233	E9		0	00
234	EA		0	00
235	EB		0	00
236	EC		0	00
237	ED		0	00
238	EE		0	00
239	EF		0	00
240	F0		0	00
241	F1		0	00
242	F2		0	00
243	F3		0	00
244	F4		0	00
245	F5		0	00
246	F6		0	00
247	F7		0	00
248	F8		0	00
249	F9		0	00
250	FA		0	00
251	FB		0	00
252	FC		0	00
253	FD		0	00
255	FE		0	00
255	FF	Zero CHECKSUM of Internal Use Area (if used). Default Value=0	255	FF

FRU (EEPROM) Data

HPS3000NF-9 FRU (EEPROM) Data:

OFFSET		DEFINITION	SPEC VALUE	
(DEC)	(HEX)	(REMARKS)	(DEC)	(HEX)
COMMON HEADER, 8 BYTES				
0	00	FORMAT VERSION NUMBER (Common Header)	1	01
1	01	INTERNAL USE AREA OFFSET (In multiples of 8 Bytes)	24	18
2	02	CHASSIS INFO AREA OFFSET (In multiples of 8 Bytes)	1	01
3	03	BOARD INFO AREA OFFSET (No Used)	0	00
4	04	PRODUCT INFO AREA OFFSET (In multiples of 8 Bytes)	5	05
5	05	MULTI RECORD AREA OFFSET (In multiples of 8 Bytes)	15	0F
6	06	PAD (reserved always 00H)	0	00
7	07	ZERO CHECK SUM (256 – (Sum of bytes 000d to 006d))	210	D2
COMPUTER/CHASSIS INFO AREA(32 BYTES)				
8	08	FORMAT VERSION NUMBER (Default is 1.)	1	01
9	09	CHASSIS INFO AREA LENGTH (Default is 0.)	0	00
10	0A	CHASSIS TYPE (Default value is 0.)	0	00
11	0B	Chassis Part Number Type/Length 10 Bytes allocation	0	00
12	0C	CHASSIS PART NUMBER BYTES (Default value is 0.)	0	00
13	0D		0	00
14	0E		0	00
15	0F		0	00
16	10		0	00
17	11		0	00
18	12		0	00
19	13		0	00
20	14		0	00
21	15		0	00
22	16	Chassis Part Number Type/Length 15 Bytes allocation 0CFH (if used) (Default value is 0.)	0	00
23	17	CHASSIS SERIAL NUMBER (Default value is 0.)	0	00
24	18		0	00
25	19		0	00
26	1A		0	00
27	1B		0	00
28	1C		0	00
29	1D		0	00
30	1E		0	00
31	1F		0	00
32	20		0	00
33	21		0	00
34	22		0	00
35	23		0	00
36	24		0	00
37	25		0	00

HPS3000NF-9 FRU (EEPROM) Data:

Rev.03.13.13 #1.2
HPS3000 Series
Page 43

OFFSET		DEFINITION (REMARKS)	SPEC VALUE	
(DEC)	(HEX)		(DEC)	(HEX)
38	26	End Tag (0C1h if used) (Default value is 0.)	0	00
39	27	ZERO CHECK SUM (From 08d to 38d if used)	255	FF
COMPUTER/CHASSIS INFO AREA(32 BYTES)				
40	28	FORMAT VERSION NUMBER	1	01
41	29	PRODUCT INFO AREA LENGTH (In multiples of 8 bytes) 80 Bytes are allocated. 80-Bytes / 8 = 0AH.	10	0A
42	2A	Language (English=19H)	25	19
43	2B	MANUFACTURER NAME TYPE / LENGTH (0C5H) 7-6: (11)b, 8-Bit ASCII + Latin 1, 5-0: (000101)b, 5-Byte Allocation	197	C5
44	2C	MANUFACTURER'S NAME 5 byte sequence "E" "N" "P"	69	45
45	2D		78	4E
46	2E		80	50
47	2F		32	20
48	30		32	20
49	31	PRODUCT NAME Type/Length (0CEH) 7-6: (11)b, 8-Bit ASCII + Latin 1, 5-0: (001110)b, 14-Byte Allocation	206	CE
50	32	PRODUCT NAME "H" "P" "S" "3" "0" "0" "0" "N" "F" "L" "9"	72	48
51	33		80	50
52	34		83	53
53	35		51	33
54	36		48	30
55	37		48	30
56	38		48	30
57	39		78	4E
58	3A		70	46
59	3B		45	2D
60	3C		57	39
61	3D		000	00
62	3E		000	00
63	3F		000	00
64	40	PART/MODEL NUMBER Type/Length (0CAH) 7-6: (11)b, 8-Bit ASCII + Latin 1, 5-0: (001000)b, 8-Byte Allocation	200	C8
65	41	Power Supply Spare Kit Number NOT APPLICABLE	000	00
66	42		000	00
67	43		000	00
68	44		000	00
69	45		000	00
70	46		000	00
71	47		000	00
72	48		000	00
73	49	Product Version Number Type/Length (0C2H) 7-6: (11)b, 8-Bit ASCII + Latin 1, 5-0: (000010)b, 2-Byte Allocation	194	C2
74	4A	Product Version Number / Auto Rev *SHOULD TRACK MODEL REVISION on IPS Sec. 1.2	XXX	XX
75	4B		XXX	XX
76	4C	Product Serial Number Type/Length (0CDH) *PRODUCT SERIAL NUMBER IS BASED ON ASTEC SERIAL NUMBER FORMAT P/N: 417-00201000 7-6: (11)b, 8-Bit ASCII + Latin 1, 5-0: (001101)b, 13-Byte Allocation	205	CD

HPS3000NF-9 FRU (EEPROM) Data:

OFFSET		DEFINITION	SPEC VALUE	
(DEC)	(HEX)	(REMARKS)	(DEC)	(HEX)
77	4D	Product Serial Number: MODEL ID "1" "6" "4" "8"	73	49
78	4E		54	36
79	4F		52	34
80	50		56	38
81	51	MANUFACTURING YEAR AND WEEK CODE Product Serial Number: MANUFACTURING YEAR AND WEEK CODE *REFER TO 417-00201000 FOR DETAILS	XXX	XX
82	52		XXX	XX
83	53	Product Serial Number: UNIQUE SERIAL NUMBER *REFER TO 417-00201000 FOR DETAILS	XXX	XX
84	54		XXX	XX
85	55		XXX	XX
86	56		XXX	XX
87	57	Product Serial Number: MODEL REVISION *SHOULD TRACK MODEL REVISION on IPS Sec. 1.2	XXX	XX
88	58		XXX	XX
Product Serial Number: MANUFACTURING LOCATION *REFER TO 417-00201000 FOR DETAILS				
89	59	"P" (P for Laguna Philippines)	80	50
90	5A	ASSET TAG 7-6: (11)b, 8-Bit ASCII + Latin 1, 5-0: (001000)b, 8-Byte Allocation	200	C8
91	5B	NO ASSET TAG	000	00
92	5C		000	00
93	5D		000	00
94	5E		000	00
95	5F		000	00
96	60		000	00
97	61		000	00
98	62		000	00
99	63	FRU File ID 7-6: (11)b, 8-Bit ASCII + Latin 1, 5-0: (010001)b, 17-Byte Allocation	209	D1
100	64	"Should track latest EEPROM Revision on IPS Sec. 1.2" NOT APPLICABLE	000	00
101	65		000	00
102	66		000	00
103	67		000	00
104	68		000	00
105	69		000	00
106	6A		000	00
107	6B		000	00
108	6C		000	00
109	6D		000	00
110	6E		000	00
111	6F		000	00
112	70		000	00
113	71		000	00
114	72	000	00	
115	73		000	00
116	74		000	00
117	75	End of Fields Marker	193	C1
118	76	RESERVED	000	00
119	77	Zero Checksum From 040d to 118d	XXX	XX

MULTI RECORD AREA : Power Supply Information 72 Bytes

HPS3000NF-9 FRU (EEPROM) Data:

Rev.03.13.13 #1.2
HPS3000 Series
Page 45

OFFSET		DEFINITION	SPEC VALUE	
(DEC)	(HEX)	(REMARKS)	(DEC)	(HEX)
MULTI RECORD AREA : Power Supply Information 72 Bytes				
Power Supply Record Header				
120	78	Record Type ID (0x00 = Power Supply Information)	000	00
121	79	7: (0)b, End of List 6-4: (000)b, Reserved 3-0: (0010)b, Record Format Version	002	02
122	7A	Record Length: 24 Bytes	24	18
123	7B	Record Checksum (Zero Checksum From 125d To 148d)	100	64
124	7C	Header Checksum (Zero Checksum From 120d To 123d)	13	82
Power Supply Record				
125	7D	Overall Capacity (Watts)	184	B8
126	7E	15-12: (0000)b, Reserved 11-0: (11111010000)b, 3000W Stored with LSB first then MSB.	011	0B
127	7F	Peak VA (Watts)	000	00
128	80	15-12: (0000)b, Reserved 11-0: No peak VA rating Stored with LSB first then MSB	000	00
129	81	Inrush Current (Amps) 40Amps	40	28
130	82	Inrush Interval (ms) 0ms	000	00
131	83	Low End Input Voltage Range 1	000	00
132	84		000	00
133	85	High End Input Voltage Range 1	000	00
134	86		000	00
135	87	Low End Input Voltage Range 2	80	50
136	88	180V = 18000 (x10mV) Stored with LSB first then MSB.	70	46
137	89	High End Input Voltage Range 2	32	20
138	8A	264V = 26400 (x10mV) Stored with LSB first then MSB.	103	67
139	8B	Low End Input Frequency Range, 47Hz	47	2F
140	8C	High End Input Frequency Range, 63Hz	63	3F
141	8D	A/C Dropout Tolerance in ms, 12ms	12	0C
142	8E	Binary Flags 7-5: (000)b, Reserved 4: (1)b, Tachometer Puls es per Rotation / Predictive Fail Polarity (2 Pulses Per Rotation = 1; 1 Pulse Per Rotation = 0) OR (Signal Asserted(1) Indicates Failure = 0, Signal Deasserted(0) Indicates Failure = 1) 3: (1)b, Hot Swap / Redundancy Support 2: (0)b, AutoSwitch Support 1: (1)b, Power Factor Correction Support 0: (0)b, Predictive Fail Support	26	1A
143	8F	Peak Wattage Capacity and Holdup Time	000	00
144	90	15-12: (0000)b, Hold Up Time in Seconds = 00H (Not Specified) 11-0: (000000000000)b, Peak Capacity in Watts = 00H (Not Specified)	000	00
145	91	Combined Wattage	000	00
146	92	NOT APPLICABLE	000	00
147	93		000	00
148	94	Predictive Fail Tachometer Lower Threshold, Not applicable	000	00

HPS3000NF-9 FRU (EEPROM) Data:

Rev.03.13.13 #1.2
HPS3000 Series
Page 46

OFFSET		DEFINITION	SPEC VALUE	
(DEC)	(HEX)	(REMARKS)	(DEC)	(HEX)
48V DC Output Record Header				
149	95	Record Type ID (0x01 = DC Output)	001	01
150	96	End Of List/Record Format Version Number 7: (0)b, End of List 6-4: (000)b, Reserved 3-0: (0010)b, Record Format Version	002	02
151	97	Record Length: 13 Bytes	013	0D
152	98	Record Checksum (Zero Checksum From 154d To 166d)	194	C2
153	99	Header Checksum (Zero Checksum From 149d To 152d)	46	2E
+48V DC Output Record				
154	9A	48V Output Information 7: (0)b, Standby 6-4: (000)b, Reserved 3-0: (0001)b, Output Number 1	001	01
155	9B	Nominal Voltage	192	C0
156	9C	48V = 4800 (x10mV) Stored with LSB first then MSB.	018	12
157	9D	Maximum Negative Voltage Deviation	224	E0
158	9E	43.2V = 4320 (x10mV) Stored with LSB first then MSB.	016	10
159	9F	Maximum Positive Voltage Deviation	160	A0
160	A0	52.8V = 5280x(10mV) Stored with LSB first then MSB.	020	14
161	A1	Ripple And Noise pk -pk 10Hz To 30MHz (mV)	224	E0
162	A2	480mV Stored with LSB first then MSB.	001	01
163	A3	Minimum Current Draw (10mA)	100	64
164	A4	1A = 100 (x10mA) Stored with LSB first then MSB.	000	00
165	A5	Maximum Current Draw (10mA)	106	6A
166	A6	62.50A = 6250 (x10mA) Stored with LSB first then MSB.	024	18
5VSB DC Output Record Header				
167	A7	Record Type ID (0x01 = DC Output)	001	01
168	A8	End Of List/Record Format Version Number 7: (1)b, End of List 6-4: (000)b, Reserved 3-0: (0010)b, Record Format Version	130	82
169	A9	Record Length: 20 Bytes	020	14
170	AA	Record Checksum (Zero Checksum From 172d To 191d)	219	DB
171	AB	Header Checksum (Zero Checksum From 167d To 170d)	142	8E
5V SB DC Output Record				
172	AC	5VSB Output Information 7: (1)b, Standby (Bit = 1 to indicate standby output) 6-4: (000)b, Reserved 3-0: (0010)b, Output Number 2 = 010b	130	82
173	AD	Nominal Voltage	244	F4
174	AE	5V = 500 (x10mV) Stored with LSB first then MSB.	001	01

HPS3000NF-9 FRU (EEPROM) Data:

Rev.03.13.13 #1.2
HPS3000 Series
Page 47

OFFSET		DEFINITION	SPEC VALUE	
(DEC)	(HEX)	(REMARKS)	(DEC)	(HEX)
175	AF	Maximum Negative Voltage Deviation 4.8V = 480 (x10mV) Stored with LSB first then MSB.	224	E0
176	B0		001	01
177	B1	Maximum Positive Voltage Deviation 5.2V = 520 (x10mV) Stored with LSB first then MSB.	008	08
178	B2		002	02
179	B3	Ripple And Noise pk -pk 10Hz To 30MHz (mV) 100mV Stored with LSB first then MSB.	100	64
180	B4		000	00
181	B5	Minimum Current Draw (10mA) 0.5A = 50(x 10mA) Stored with LSB first then MSB.	050	32
182	B6		000	00
183	B7	Maximum Current Draw (10mA) 3.00A = 300(x 10mA) Stored with LSB first then MSB.	044	2C
184	B8		001	01
185	B9	Reserved	000	00
186	BA	Reserved	000	00
187	BB	Reserved	000	00
188	BC	Reserved	000	00
189	BD	Reserved	000	00
190	BE	Reserved	000	00
191	BF	Reserved	000	00
INTERNATIONAL USE AREA, 64 BYTES				
192	C0	Format Version Number 7:4 -reserved, write as 0000b 3:0 -format version number = 1h for this specification.	001	01
193	C1		0	00
194	C2		0	00
195	C3		0	00
196	C4		0	00
197	C5		0	00
198	C6		0	00
199	C7		0	00
200	C8		0	00
201	C9		0	00
202	CA		0	00
203	CB		0	00
204	CC		0	00
205	CD		0	00
206	CE		0	00
207	CF		0	00
208	D0		0	00
209	D1		0	00
210	D2		0	00
211	D3		0	00
212	D4		0	00
213	D5		0	00
214	D6		0	00
215	D7		0	00
216	D8		0	00
217	D9		0	00
218	DA		0	00
219	DB		0	00
220	DC		0	00

HPS3000NF-9 FRU (EEPROM) Data:

Rev.03.13.13_#1.2
HPS3000 Series
Page 48

OFFSET		DEFINITION	SPEC VALUE	
(DEC)	(HEX)	(REMARKS)	(DEC)	(HEX)
221	DD		0	00
222	DE		0	00
223	DF		0	00
224	E0		0	00
225	E1		0	00
226	E2		0	00
227	E3		0	00
228	E4		0	00
229	E5		0	00
230	E6		0	00
231	E7		0	00
232	E8		0	00
233	E9		0	00
234	EA		0	00
235	EB		0	00
236	EC		0	00
237	ED		0	00
238	EE		0	00
239	EF		0	00
240	F0		0	00
241	F1		0	00
242	F2		0	00
243	F3		0	00
244	F4		0	00
245	F5		0	00
246	F6		0	00
247	F7		0	00
248	F8		0	00
249	F9		0	00
250	FA		0	00
251	FB		0	00
252	FC		0	00
253	FD		0	00
255	FE		0	00
255	FF	Zero CHECKSUM of Internal Use Area (if used). Default Value=0	255	FF

The HPS3000 is compliant with the industry standard PMBus™ protocol for monitoring and control of the power supply via the I²C interface port.

HPS3000 Series PMBus™ General Instructions

Equipment Setup

The following is typical I²C communication setup:

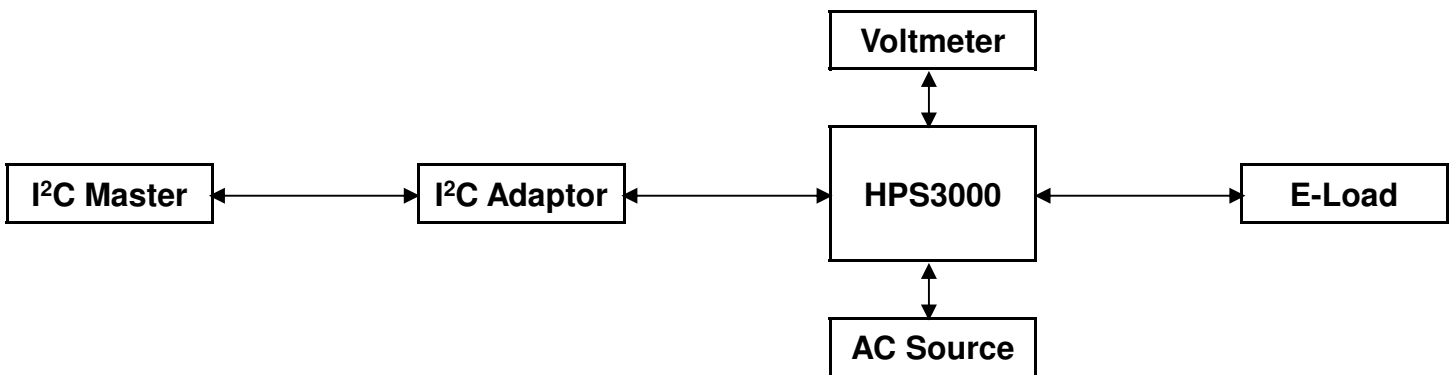

PMBus™ Writing Instructions

When writing to any PMBus™ R/W registers, ALWAYS do the following:

Disable Write Protect (command 10h) by writing any of the following accordingly:

- Levels: 00h – Enable writing to all writeable commands
- 20h – Disables write except 10h, 01h, 00h, 02h and 21h commands
- 40h – Disables write except 10h, 01h, and 00h commands
- 80h – Disable write except 0x00h

To save changes on the USER PMBus™ Table:

Use send byte command: 15h STORE_USER_ALL

To save changes on the DEFAULT PMBus™ Table:

Use send byte command: 11h STORE_DEFAULT_ALL

Wait for 5 seconds, turn-off the PSU, wait for another 5 seconds before turning it on.

HPS3000 Series Support PMBus™ Command List

Rev.03.13.13 #1.2
HPS3000 Series
Page 50

The HPS3000 is compliant with the industry standard PMBus™ protocol for monitoring and control of the power supply via the i²C interface port.

HPS3000-9 Series Supported PMBus™ Command List:

Command Code	Command Name	Default Value	Access Type	Data Bytes	Data Format	Description
00h	Page	00	R/W	1		Configure, control and monitor function
01h	OPERATION	80	R/W	1		Used to turn the unit ON/OFF in conjunction with the input PS_ON pin.
	b7:6	10b				00 – Immediate Turn OFF (No Sequencing) 01 – Soft Turn OFF (With Sequencing) 10 – PSU ON
	b5:4	00b				
	b3:2	00b				
	b1:0	00b				Reserved
02h	ON_OFF_CONFIG	1C	R	1		Configures the combination of PS_ON pin and serial communication commands needed to turn the unit ON/OFF.
	b7:5	000				Reserved
	b4 – Enable PS_ON pin and Serial communication control.	1				0 – Unit powers up any time power is present regardless of the state of PS_ON pin. 1 – Unit powers up as dictated by PS_ON pin and OPERATION command (b3:0) .
	b3 – Serial communication Control	1				0 – Unit Ignores ON/OFF portion of the OPERATION command. 1 – Enables Serial communication ON/OFF portion of OPERATION command. Requires PS_ON pin to be asserted for the unit to start and energize the output.
	b2 – Sets how the unit responds to PS_ON pin	1				0 – Unit ignores PS_ON pin. (ON/OFF controlled by OPERATION command). 1 – Unit requires PS_ON pin to be asserted to start the unit.
	b1 – PS_ON pin polarity	0				0 – Active Low (Pull Low to start the unit). 1 – Active high (Pull high to start the unit).
	b0 – PS_ONL pin action	0				0 – Use programmed turn ON/OFF delay. 1 – Turn OFF the output and stop transferring energy to the output as fast as possible.
03h	CLEAR_FAULTS	0	S			
10h	WRITE_PROTECT	00	R/W	1		Used to Control Writing to the PMBus Device 80h - Disables write except 10h 40h – Disables write except 10h, 01h, 00h 20h – Disables write except 10h,01h,00h,02h and 21h commands 00 – Enables write to all writeable commands.
15h	STORE_USER_ALL	-	S	0		Copies the Operating memory table to the matching USER non-volatile memory.
16h	RESTORE_USER_ALL	-	S	0		Copies the entire USER non-volatile memory to the Operating memory table.

HPS3000-9 Series Supported PMBus™ Command List:

Rev.03.13.13 #1.2
 HPS3000 Series
 Page 51

Command Code	Command Name	Default Value	Access Type	Data Bytes	Data Format	Description
19h	CAPABILITY	90	R	1		Provides a way for the hosts system to determine some key capabilities of a PMBus™ device.
	b7 - Packet Error Checking	0				0 - PEC not supported 1 - PEC supported
	b6 - Maximum Bus Speed	1				0 - Maximum supported bus speed, 100khz 1 - Maximum supported bus speed, 400khz
	b5 - SMBALERT#	0				0 – SMBus Alert Pin <i>not supported</i> 1 – SMBus Alert Pin <i>supported</i>
	b4:0	00000				Reserved
20h	VOUT_MODE	17	R	1		Specifies the mode and parameters of Output Voltage related Data Formats
21h	VOUT_COMMAND	6600	R/W	2	Linear	Sets 48V Output Voltage Reference Vout command sends discreet value to change or trim output voltage. The value acts as Digital reference of the Power supply after additional operations are performed (to make the representation compatible). Affects OVP_WARNING and FAULT LIMIT, as well as POWER_GOOD_ON/OFF level.
22h	VOUT_TRIM	0000	R/W	2		0
23h	VOUT_CAL_OFFSET	0000	R/W	2		Variable. Used by Factory to trim Vout Default before trimming, 0000.
24h	VOUT_MAX	7033	R	2	Linear	Sets the max adjustable output voltage limit. 56.1V.
31h	POUT_MAX	13B9	R	2	Linear	Sets the operating power limit condition. 3812W
35h	VIN_ON	EAC0	R	2	Linear	Sets the value of input, in volts, at which the unit should start. ACGOOD 88Vac
36h	VIN_OFF	EA80	R	2	Linear	Sets the value of input, in volts, at which the unit should stop power conversion. ACBAD 80Vac
3Ah	FAN_CONFIG_1_2	99	R	1		Used to configure up to 2 fans associated with one PMBus device
	b7	1				1 – Fan is installed in position 1 0 – No Fan is installed in position 1
	b6	0				1 – Fan is commanded in RPM 0 – Fan is commanded in DC
	b5:4	01				00 – 1 pulse per revolution 01 – 2 pulses per revolution 10 – 3 pulses per revolution 11 – 4 pulses per revolution
	b3	1				1 – Fan is installed in position 2 0 – No Fan is installed in position 2
	b2	0				1 – Fan is commanded in RPM 0 – Fan is commanded in DC
	b1:0	01				00 – 1 pulse per revolution 01 – 2 pulses per revolution 10 – 3 pulses per revolution 11 – 4 pulses per revolution

HPS3000-9 Series Supported PMBus™ Command List:

Rev.03.13.13 #1.2
HPS3000 Series
Page 52

Command Code	Command Name	Default Value	Access Type	Data Bytes	Data Format	Description
3Bh	FAN_COMMAND_1	0000	R/W	2	Linear	Adjusts the operation of the Fans. The device may override the command, if it requires higher value, to maintain proper device temperature. RPM Control – Commands Speeds from 0-20096 RPM. Duty cycle Control – Commands Speeds from 0 to 100%
3Ch	FAN_COMMAND_2	0000	R/W	2	Linear	Adjusts the operation of the Fans. The device may override the command, if it requires higher value, to maintain proper device temperature. RPM Control – Commands Speeds from 0-20096 RPM. Duty cycle Control – Commands Speeds from 0 to 100%
40h	VOUT_OV_FAULT_LIMIT	7333	R/W	2	Linear	Sets Output Over voltage threshold. (57.6V)
41h	VOUT_OV_FAULT_RESPONSE	80	R	1		Unit Latches OFF. Resets on PSON or CONTROL pin recycle or AC recycle.
42h	VOUT_OV_WARN_LIMIT	6E61	R/W	2	Linear	Sets Over-voltage Warning threshold. (55.2V)
43h	VOUT_UV_WARN_LIMIT	5993	R/W	2	Linear	Sets Under-voltage Warning threshold. (44.8V)
44h	VOUT_UV_FAULT_LIMIT	5200	R/W	2	Linear	Sets Under-voltage Fault threshold. (41V)
45h	VOUT_UV_FAULT_RESPONSE	80	R	1		Turn PSU OFF
46h	IOUT_OC_FAULT_LIMIT	EA70	R	2	Linear	Sets the Over current threshold in Amps. (78A for Hi Line)
47h	IOUT_OC_FAULT_RESPONSE	80	R	1		OCP ride through. If OCP persists.
4Ah	IOUT_OC_WARN_LIMIT	EA24	R	2	Linear	Sets the Over Current Warning threshold in Amps. (68.5A for Hi Line)
4Fh	OT_FAULT_LIMIT	E320	R	2	Linear	Secondary ambient temperature Fault threshold, in degree C. (50degC)
50h	OT_FAULT_RESPONSE	C0	R	1		Turn PSU OFF and will retry indefinitely
51h	OT_WARN_LIMIT	E2D0	R	2	Linear	Secondary ambient temperature warning threshold, in degree C. Operating limit. refer to section 3.1. (45 degC)
55h	VIN_OV_FAULT_LIMIT	FA26	R	2	Linear	Sets input over-voltage threshold. (275Vac)
56h	VIN_OV_FAULT_RESPONSE	C0	R	1		No interruption.
59h	VIN_UV_FAULT_LIMIT	EA80	R	2	Linear	(80Vac)
5Ah	VIN_UV_FAULT_RESPONSE	C0	R	1		
5Bh	IIN_OC_FAULT_LIMIT	DA80	R	2	Linear	Sets the threshold for input current that causes over-current fault within 100ms. (20A)
5Ch	IIN-OC-FAULT_RESPONSE	80	R	1		Turn PSU OFF. cleared upon AC recycle.
60h	TON_DELAY	F320	R	2	Linear	Sets the time (sec), from start condition (Power ON) until the output starts to rise. (2sec)
61h	TON_RISE	F2A8	R	2	Linear	Sets the time (ms), for the output rises from 5 to regulation. (300ms)

HPS3000-9 Series Supported PMBus™ Command List:

Rev.03.13.13 #1.2
HPS3000 Series
Page 53

Command Code	Command Name	Default Value	Access Type	Data Bytes	Data Format	Description
78h	STATUS_BYTE		R	1		Returns the summary of critical faults
	b7 – BUSY					A fault was declared because the device was busy and unable to respond.
	b6 – OFF					Unit is OFF
	b5 – VOUT_OV					Output over-voltage fault has occurred
	b4 – IOUT_OC					Output over-current fault has occurred
	b3 - VIN_UV					An input under-voltage fault has occurred
	b2 – TEMPERATURE					A temperature fault or warning has occurred
	b1 – CML					A communication, memory or logic fault has occurred.
	b0 – NONE OF THE ABOVE					A Fault Warning not listed in bits[7:1] has occurred.
79h	STATUS_WORD		R	2		Summary of units Fault and warning status.
	b15 – VOUT					An output voltage fault or warning has occurred
	b14 – IOUT/POUT					An Output current or power fault or warning has occurred.
	b13 – INPUT					An input voltage, current or power fault or warning as occurred.
	b12 – MFR					A manufacturer specific fault or warning has occurred.
	b11 – POWER_GOOD#					The POWER_GOOD signal is de-asserted
	b10 - FANS					A fan or airflow fault or warning has occurred.
	b9 – OTHER					A bit in STATUS_OTHER is set.
	b8 – UNKOWN					A fault type not given in bits [15:1] of the STATUS_WORD has been detected.
	b7 – BUSY					A fault was declared because the device was busy and unable to respond.
	b6 – OFF					Unit is OFF
	b5 – VOUT_OV					Output over-voltage fault has occurred
	b4 – IOUT_OC					Output over-current fault has occurred
	b3 - VIN_UV					An input under-voltage fault has occurred
	b2 – TEMPERATURE					A temperature fault or warning has occurred
	b1 – CML					A communication, memory or logic fault has occurred.
b0 – NONE_OF_THE_ABOVE					A fault or warning not listed in bits[7:1] of this byte has occurred.	

HPS3000-9 Series Supported PMBus™ Command List:

Rev.03.13.13 #1.2
HPS3000 Series
Page 54

Command Code	Command Name	Default Value	Access Type	Data Bytes	Data Format	Description
7Ah	STATUS_VOUT	-	R	1		Output voltage related faults and warnings
	b7					VOUT Over-voltage Fault
	b6					VOUT Over-voltage warning
	b5					VOUT Under-voltage Warning
	b4					VOUT Under-voltage Fault
	b3					VOUT_MAX Warning, an attempt has been made to set output to a value higher than the highest permissible voltage.
	b2					TON_MAX_FAULT
	b1					TOFF_MAX Warning
	b0					reserved
7Bh	STATUS_IOUT		R	1		Output Current related faults and warnings
	b7					IOUT Over current Fault
	b6					IOUT Over current And Low Voltage shutdown Fault
	b5					VOUT Under-voltage Warning
	b4					VOUT Under-voltage Fault
	b3					VOUT_MAX Warning, an attempt has been made to set output to a value higher than the highest permissible voltage.
	b2					TON_MAX_FAULT
	b1					TOFF_MAX Warning
	b0					reserved
7Ch	STATUS_INPUT	-	R	1		Input related faults and warnings
	b7					VIN Overvoltage Fault
	b6					VIN Overvoltage Warning
	b5					VIN Undervoltage Warning
	b4					VIN Undervoltage Fault
	b3					Unit is OFF for insufficient Input Voltage
	b2					IIN Overcurrent Fault
	b1					IIN Overcurrent Warning
	b0					PIN overpower Warning
7Dh	STATUS_TEMPERATURE	-	R	1		Temperature related faults and warnings
	b7					Overtemperature Fault
	b6					Overtemperature Warning
	b5					Undertemperature Warning
	b4					Undertemperature Fault
	b3:0					reserved
7Eh	STATUS_CML	-	R	1		Communications, Logic and Memory
	b7					Invalid or unsupported Command Received
	b6					
	b5					Packet Error Check Failed
	b4					Memory Fault Detect, CRC Error
	b3					
	b2					
	b1					
b0						

HPS3000-9 Series Supported PMBus™ Command List:

Rev.03.13.13 #1.2
HPS3000 Series
Page 55

Command Code	Command Name	Default Value	Access Type	Data Bytes	Data Format	Description
80h	STATUS_MFR_SPECIFIC	-	R	1		Manufacturer Status codes (Debugging Purposes)
	b7					Bulk OK, 1- Bulk is within range and is ready for use
	b6					Not Used
	b5					Running Sckt
	b4					Start-Up Sckt
	b3					Standby Under Voltage
	b2					Standby OCP
	b1					Rail Fault
	b0					PS_ON Pin Status 1 – asserted, 0 - deasserted
81h	STATUS_FANS_1_2	-	R	1		
	b7					Fan 1 Fault
	b6					Fan 2 Fault
	b5					Fan 1 Warning
	b4					Fan 2 Warning
	b3					Fan_1 Speed Overridden
	b2					Fan_2 Speed Overridden
	b1					
	b0					
88h	READ_VIN	-	R	2	Linear	Returns input Voltage in Volts ac.
89h	READ_IIN	-	R	2	Linear	Returns input Current in Amperes
8Ah	READ_VCAP	-	R	2	Linear	Returns Bulk Capacitor voltage in Volts
8Bh	READ_VOUT	-	R	2	Linear	Returns the actual, measured voltage in Volts.
8Ch	READ_IOUT	-	R	2	Linear	Returns the output current in amperes.
8Dh	READ_TEMPERATURE_1	-	R	2	Linear	PSU Air inlet temp (inside PSU)
8Eh	READ_TEMPERATURE_2	-	R	2	Linear	PSU Air inlet temp (inside PSU)
90h	READ_FAN_SPEED_1	-	R	2	Linear	Speed of Fan 1
90h	READ_FAN_SPEED_2	-	R	2	Linear	Speed of Fan 2
96h	READ_POUT	-	R	2	Linear	Returns the output power, in Watts.
97h	READ_PIN	-	R	2	Linear	Returns the input power, in Watts.
98h	PMBUS_REVISION	11	R	1		Reads the PMBus revision number
	b7:5	0001				Part 1 Revision 0000 – Revision 1.0 0001 – Revision 1.1
	b4:0	0001				Part 2 Revision 0000 – Revision 1.0 0001 – Revision 1.1
99h	MFR_ID	07 45 4D 45 52 53 30 4E	R	8		Abbrev or symbol of manufacturers name.
9Ah	MFR_MODEL	09 48 50 53 33 30 30 30 2D 39	R	10		Manufacturers Model number,
9Bh	MFR_REVISION	02 30 41	R	3		Manufacturers, revision number,
9Ch	MFR_LOCATION	04 50 68 69 6C	R	4		Manufacturers facility, ASCII format
A0h	MFR_VIN_MIN	EAD0	R	2	Linear	Minimum Input Voltage (90Vac)
A1h	MFR_VIN_MAX	FA 10	R	2	Linear	Maximum Input Voltage (264Vac)
A2h	MFR_IIN_MAX	DA20	R	2	Linear	Maximum Input Current (19A)

HPS3000-9 Series Supported PMBus™ Command List:

Rev.03.13.13_#1.2
HPS3000 Series
Page 56

Command Code	Command Name	Default Value	Access Type	Data Bytes	Data Format	Description
A3	MFR_PIN_MAX	13 41			Linear	Maximum Input Power (3332W for High Line)
A4h	MFR_VOUT_MIN	5B CD	R	2	Linear	Minimum Output Voltage Regulation Window. (45.9V)
A5h	MFR_VOUT_MAX	70 33	R	2	Linear	Maximum Output Voltage. Regulation Window (56.1V)
A6h	MFR_IOUT_MAX	E3 E8	R	2	Linear	Maximum Output Current (62.5A for High Line)
A7h	MFR_POUT_MAX	12 EE	R	2	Linear	Maximum Output Power (3000W for High Line)
A8h	MFR_TAMBIENT_MAX	E2 80	R	2	Linear	Maximum Operating Ambient Temperature (Secondary Ambient) (40 degC)
ABh	MFR_EFFICIENCY_HL	0E C8 00 00 00 00 00 00 00 00 00 EE 12 5A 00	R		Direct	Efficiency at high line condition.

HPS3000NF-9 Series Supported PMBus™ Command List:

Rev.03.13.13 #1.2
HPS3000 Series
Page 57

Command Code	Command Name	Default Value	Access Type	Data Bytes	Data Format	Description
00h	Page	00	R/W	1		Configure, control and monitor function
01h	OPERATION	80	R/W	1		Used to turn the unit ON/OFF in conjunction with the input PS_ON pin.
	b7:6	10b				00 – Immediate Turn OFF (No Sequencing) 01 – Soft Turn OFF (With Sequencing) 10 – PSU ON
	b5:4	00b				
	b3:2	00b				
	b1:0	00b				Reserved
02h	ON_OFF_CONFIG	1C	R	1		Configures the combination of PS_ON pin and serial communication commands needed to turn the unit ON/OFF.
	b7:5	000				Reserved
	b4 – Enable PS_ON pin and Serial communication control.	1				0 – Unit powers up any time power is present regardless of the state of PS_ON pin. 1 – Unit powers up as dictated by PS_ON pin and OPERATION command (b3:0) .
	b3 – Serial communication Control	1				0 – Unit Ignores ON/OFF portion of the OPERATION command. 1 – Enables Serial communication ON/OFF portion of OPERATION command. Requires PS_ON pin to be asserted for the unit to start and energize the output.
	b2 – Sets how the unit responds to PS_ON pin	1				0 – Unit ignores PS_ON pin. (ON/OFF controlled by OPERATION command). 1 – Unit requires PS_ON pin to be asserted to start the unit.
	b1 – PS_ON pin polarity	0				0 – Active Low (Pull Low to start the unit). 1 – Active high (Pull high to start the unit).
	b0 – PS_ONL pin action	0				0 – Use programmed turn ON/OFF delay. 1 – Turn OFF the output and stop transferring energy to the output as fast as possible.
03h	CLEAR_FAULTS	0	S			
10h	WRITE_PROTECT	00	R/W	1		Used to Control Writing to the PMBus Device 80h - Disables write except 10h 40h – Disables write except 10h, 01h, 00h 20h – Disables write except 10h,01h,00h,02h and 21h commands 00 – Enables write to all writeable commands.
15h	STORE_USER_ALL	-	S	0		Copies the Operating memory table to the matching USER non-volatile memory.
16h	RESTORE_USER_ALL	-	S	0		Copies the entire USER non-volatile memory to the Operating memory table.
19h	CAPABILITY	90	R	1		Provides a way for the hosts system to determine some key capabilities of a PMBus™ device.
	b7 - Packet Error Checking	0				0 - PEC not supported 1 - PEC supported
	b6 - Maximum Bus Speed	1				0 - Maximum supported bus speed, 100khz 1 - Maximum supported bus speed, 400khz
	b5 - SMBALERT#	0				0 – SMBus Alert Pin <i>not supported</i> 1 – SMBus Alert Pin <i>supported</i>
	b4:0	00000				Reserved

HPS3000NF-9 Series Supported PMBus™ Command List:

Rev.03.13.13 #1.2
HPS3000 Series
Page 58

Command Code	Command Name	Default Value	Access Type	Data Bytes	Data Format	Description
20h	VOUT_MODE	17	R	1		Specifies the mode and parameters of Output Voltage related Data Formats
21h	VOUT_COMMAND	6600	R/W	2	Linear	Sets 48V Output Voltage Reference Vout command sends discreet value to change or trim output voltage. The value acts as Digital reference of the Power supply after additional operations are performed (to make the representation compatible). Affects OVP_WARNING and FAULT LIMIT, as well as POWER_GOOD_ON/OFF level.
22h	VOUT_TRIM	0000	R/W	2		0
23h	VOUT_CAL_OFFSET	0000	R/W	2		Variable. Used by Factory to trim Vout Default before trimming, 0000.
24h	VOUT_MAX	7033	R	2	Linear	Sets the max adjustable output voltage limit. 56.1V.
31h	POUT_MAX	13B9	R	2	Linear	Sets the operating power limit condition. 3812W
35h	VIN_ON	EAC0	R	2	Linear	Sets the value of input, in volts, at which the unit should start. ACGOOD 88Vac
36h	VIN_OFF	EA80	R	2	Linear	Sets the value of input, in volts, at which the unit should stop power conversion. ACBAD 80Vac
40h	VOUT_OV_FAULT_LIMIT	7333	R/W	2	Linear	Sets Output Over voltage threshold. (57.6V)
41h	VOUT_OV_FAULT_RESPONSE	80	R	1		Unit Latches OFF. Resets on PSON or CONTROL pin recycle or AC recycle.
42h	VOUT_OV_WARN_LIMIT	6E61	R/W	2	Linear	Sets Over-voltage Warning threshold. (55.2V)
43h	VOUT_UV_WARN_LIMIT	5993	R/W	2	Linear	Sets Under-voltage Warning threshold. (44.8V)
44h	VOUT_UV_FAULT_LIMIT	5200	R/W	2	Linear	Sets Under-voltage Fault threshold. (41V)
45h	VOUT_UV_FAULT_RESPONSE	80	R	1		Turn PSU OFF
46h	IOUT_OC_FAULT_LIMIT	EA70	R	2	Linear	Sets the Over current threshold in Amps. (78A for Hi Line)
47h	IOUT_OC_FAULT_RESPONSE	80	R	1		OCP ride through. If OCP persists.
4Ah	IOUT_OC_WARN_LIMIT	EA24	R	2	Linear	Sets the Over Current Warning threshold in Amps. (68.5A for Hi Line)
4Fh	OT_FAULT_LIMIT	E320	R	2	Linear	Secondary ambient temperature Fault threshold, in degree C. (50degC)
50h	OT_FAULT_RESPONSE	C0	R	1		Turn PSU OFF and will retry indefinitely
51h	OT_WARN_LIMIT	E2D0	R	2	Linear	Secondary ambient temperature warning threshold, in degree C. Operating limit. refer to section 3.1. (45 degC)
55h	VIN_OV_FAULT_LIMIT	FA26	R	2	Linear	Sets input over-voltage threshold. (275Vac)
56h	VIN_OV_FAULT_RESPONSE	C0	R	1		No interruption.
59h	VIN_UV_FAULT_LIMIT	EA80	R	2	Linear	(80Vac)
5Ah	VIN_UV_FAULT_RESPONSE	C0	R	1		
5Bh	IIN_OC_FAULT_LIMIT	DA80	R	2	Linear	Sets the threshold for input current that causes over-current fault within 100ms. (20A)
5Ch	IIN-OC-FAULT_RESPONSE	80	R	1		Turn PSU OFF. cleared upon AC recycle.
60h	TON_DELAY	F320	R	2	Linear	Sets the time (sec), from start condition (Power ON) until the output starts to rise. (2sec)
61h	TON_RISE	F2A8	R	2	Linear	Sets the time (ms), for the output rises from 5 to regulation. (300ms)

HPS3000NF-9 Series Supported PMBus™ Command List:

Rev.03.13.13 #1.2
HPS3000 Series
Page 59

Command Code	Command Name	Default Value	Access Type	Data Bytes	Data Format	Description
78h	STATUS_BYTE		R	1		Returns the summary of critical faults
	b7 – BUSY					A fault was declared because the device was busy and unable to respond.
	b6 – OFF					Unit is OFF
	b5 – VOUT_OV					Output over-voltage fault has occurred
	b4 – IOUT_OC					Output over-current fault has occurred
	b3 - VIN_UV					An input under-voltage fault has occurred
	b2 - TEMPERATURE					A temperature fault or warning has occurred
	b1 – CML					A communication, memory or logic fault has occurred.
	b0 – NONE OF THE ABOVE					A Fault Warning not listed in bits[7:1] has occurred.
79h	STATUS_WORD		R	2		Summary of units Fault and warning status.
	b15 – VOUT					An output voltage fault or warning has occurred
	b14 – IOUT/POUT					An Output current or power fault or warning has occurred.
	b13 – INPUT					An input voltage, current or power fault or warning as occurred.
	b12 – MFR					A manufacturer specific fault or warning has occurred.
	b11 – POWER_GOOD#					The POWER_GOOD signal is de-asserted
	b10 - FANS					A fan or airflow fault or warning has occurred.
	b9 – OTHER					A bit in STATUS_OTHER is set.
	b8 – UNKNOWN					A fault type not given in bits [15:1] of the STATUS_WORD has been detected.
	b7 – BUSY					A fault was declared because the device was busy and unable to respond.
	b6 – OFF					Unit is OFF
	b5 – VOUT_OV					Output over-voltage fault has occurred
	b4 – IOUT_OC					Output over-current fault has occurred
	b3 - VIN_UV					An input under-voltage fault has occurred
	b2 – TEMPERATURE					A temperature fault or warning has occurred
	b1 – CML					A communication, memory or logic fault has occurred.
b0 – NONE_OF_THE_ABOVE					A fault or warning not listed in bits[7:1] of this byte has occurred.	

HPS3000NF-9 Series Supported PMBus™ Command List:

Rev.03.13.13 #1.2
HPS3000 Series
Page 60

Command Code	Command Name	Default Value	Access Type	Data Bytes	Data Format	Description
7Ah	STATUS_VOUT	-	R	1		Output voltage related faults and warnings
	b7					VOUT Over-voltage Fault
	b6					VOUT Over-voltage warning
	b5					VOUT Under-voltage Warning
	b4					VOUT Under-voltage Fault
	b3					VOUT_MAX Warning, an attempt has been made to set output to a value higher than the highest permissible voltage.
	b2					TON_MAX_FAULT
	b1					TOFF_MAX Warning
	b0					reserved
7Bh	STATUS_IOUT		R	1		Output Current related faults and warnings
	b7					IOUT Over current Fault
	b6					IOUT Over current And Low Voltage shutdown Fault
	b5					VOUT Under-voltage Warning
	b4					VOUT Under-voltage Fault
	b3					VOUT_MAX Warning, an attempt has been made to set output to a value higher than the highest permissible voltage.
	b2					TON_MAX_FAULT
	b1					TOFF_MAX Warning
	b0					reserved
7Ch	STATUS_INPUT	-	R	1		Input related faults and warnings
	b7					VIN Overvoltage Fault
	b6					VIN Overvoltage Warning
	b5					VIN Undervoltage Warning
	b4					VIN Undervoltage Fault
	b3					Unit is OFF for insufficient Input Voltage
	b2					IIN Overcurrent Fault
	b1					IIN Overcurrent Warning
	b0					PIN overpower Warning
7Dh	STATUS_TEMPERATURE	-	R	1		Temperature related faults and warnings
	b7					Overtemperature Fault
	b6					Overtemperature Warning
	b5					Undertemperature Warning
	b4					Undertemperature Fault
	b3:0					reserved
7Eh	STATUS_CML	-	R	1		Communications, Logic and Memory
	b7					Invalid or unsupported Command Received
	b6					
	b5					Packet Error Check Failed
	b4					Memory Fault Detect, CRC Error
	b3					
	b2					
	b1					
	b0					

HPS3000NF-9 Series Supported PMBus™ Command List:

Rev.03.13.13 #1.2
HPS3000 Series
Page 61

Command Code	Command Name	Default Value	Access Type	Data Bytes	Data Format	Description
80h	STATUS_MFR_SPECIFIC	-	R	1		Manufacturer Status codes (Debugging Purposes)
	b7					Bulk OK, 1- Bulk is within range and is ready for use
	b6					Not Used
	b5					Running Sckt
	b4					Start-Up Sckt
	b3					Standby Under Voltage
	b2					Standby OCP
	b1					Rail Fault
	b0					PS_ON Pin Status 1 – asserted, 0 - deasserted
88h	READ_VIN	-	R	2	Linear	Returns input Voltage in Volts ac.
89h	READ_IIN	-	R	2	Linear	Returns input Current in Amperes
8Ah	READ_VCAP	-	R	2	Linear	Returns Bulk Capacitor voltage in Volts
8Bh	READ_VOUT	-	R	2	Linear	Returns the actual, measured voltage in Volts.
8Ch	READ_IOUT	-	R	2	Linear	Returns the output current in amperes.
8Dh	READ_TEMPERATURE_1	-	R	2	Linear	PSU Air inlet temp (inside PSU)
8Eh	READ_TEMPERATURE_2	-	R	2	Linear	PSU Air inlet temp (inside PSU)
96h	READ_POUT	-	R	2	Linear	Returns the output power, in Watts.
97h	READ_PIN	-	R	2	Linear	Returns the input power, in Watts.
98h	PMBUS_REVISION	11	R	1		Reads the PMBus revision number
	b7:5	0001				Part 1 Revision 0000 – Revision 1.0 0001 – Revision 1.1
	b4:0	0001				Part 2 Revision0000 – Revision 1.00001 – Revision 1.1
99h	MFR_ID	07 45 4D 45 52 53 30 4E	R	8		Abbrev or symbol of manufacturers name.
9Ah	MFR_MODEL	0B 48 50 53 33 30 30 30 4E 46 2D 39	R	12		Manufacturers Model number,
9Bh	MFR_REVISION	02 30 41	R	3		Manufacturers, revision number,
9Ch	MFR_LOCATION	04 50 68 69 6C	R	4		Manufacturers facility, ASCII format
A0h	MFR_VIN_MIN	EAD0	R	2	Linear	Minimum Input Voltage (90Vac)
A1h	MFR_VIN_MAX	FA 10	R	2	Linear	Maximum Input Voltage (264Vac)
A2h	MFR_IIN_MAX	DA20	R	2	Linear	Maximum Input Current (19A)
A3	MFR_PIN_MAX	13 41			Linear	Maximum Input Power (3332W for High Line)
A4h	MFR_VOUT_MIN	5BCD	R	2	Linear	Minimum Output Voltage Regulation Window. (45.9 V)
A5h	MFR_VOUT_MAX	70 33	R	2	Linear	Maximum Output Voltage. Regulation Window (56.1V)
A6h	MFR_IOUT_MAX	E3 E8	R	2	Linear	Maximum Output Current (62.5A for High Line)
A7h	MFR_POUT_MAX	12 EE	R	2	Linear	Maximum Output Power (3000W for High Line)
A8h	MFR_TAMBIENT_MAX	E2 80	R	2	Linear	Maximum Operating Ambient Temperature (Secondary Ambient) (40 degC)
ABh	MFR_EFFICIENCY_HL	0E C8 00 00 00 00 00 00 00 00 00 EE 12 5A 00	R		Direct	Efficiency at high line condition.

Application Notes

Rev.03.13.13_#1.2
HPS3000 Series
Page 62

Current Sharing

The HPS3000 series' main output V_O is equipped with current sharing capability. This will allow up to 4 power supplies to be connected in parallel for higher power application. Current share accuracy is typically 10% of full load. Below 10% total loading, there is no guarantee of output current sharing.

Redundancy / Fault Tolerance

The HPS3000 series power supplies will allow up to 4 power supplies to be connected in an N+1 redundant load.

Any failure of one power supply in parallel as well as hot swapping shall not cause more than a 5% change in any output. The Failure of one or more supplies will not cause the remaining supplies to violate any of the input or output specifications noted in this specification including all status signals.

Output Ripple and Noise Measurement

Rev.03.13.13_#1.2
HPS3000 Series
Page 63

The setup outlined in the diagram below has been used for output voltage ripple and noise measurements on the HPS3000 Series. When measuring output ripple and noise, a scope jack in parallel with a $0.1\mu\text{F}$ ceramic chip capacitor, and a $10\mu\text{F}$ aluminum electrolytic capacitor should be used. Oscilloscope should be set to 20MHz bandwidth for this measurement.

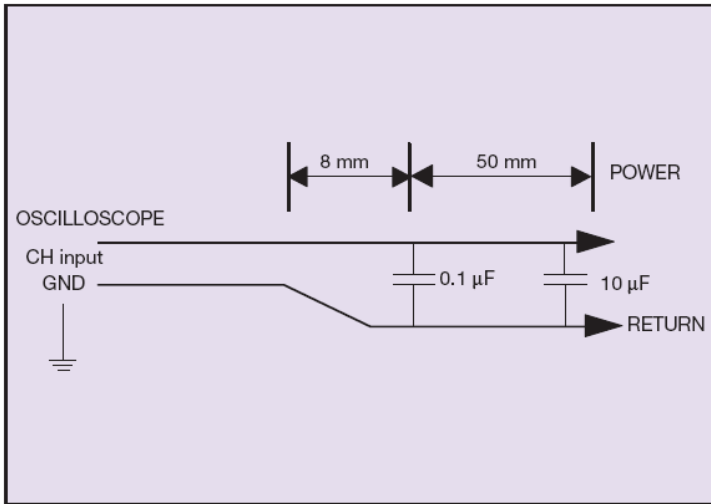

Americas

5810 Van Allen Way
Carlsbad, CA 92008
USA
Telephone: +1 (760) 930 4600
Facsimile: +1 (760) 930 0698

Europe (UK)

Waterfront Business Park
Merry Hill, Dudley
West Midlands, DY5 1LX
United Kingdom
Telephone: +44 (0) 1384 842 211
Facsimile: +44 (0) 1384 843 355

Asia (HK)

14/F, Lu Plaza
2 Wing Yip Street
Kwun Tong, Kowloon
Hong Kong
Telephone: +852 2176 3333
Facsimile: +852 2176 3888

For global contact, visit:

www.powerconversion.com

techsupport.embeddedpower@emerson.com

While every precaution has been taken to ensure accuracy and completeness in this literature, Emerson Network Power assumes no responsibility, and disclaims all liability for damages resulting from use of this information or for any errors or omissions.

Emerson Network Power.

The global leader in enabling business-critical continuity.

- AC Power
- Connectivity
- DC Power
- Embedded Computing
- **Embedded Power**
- Monitoring
- Outside Plant
- Power Switching & Controls
- Precision Cooling
- Racks & Integrated Cabinets
- Services
- Surge Protection

EmersonNetworkPower.Com

Emerson Network Power and the Emerson Network Power logo are trademarks and service marks of Emerson Electric Co.
©2008 Emerson Electric Co.