

# APPROVAL SHEET



**WQCF2012FH Series**  
**COMMON MODE CHOKE**  
**AEC-Q200**

\*Contents in this sheet are subject to change without prior notice.

## Features

1. Wire wound type common mode choke.
2. Excellent solderability.
3. AEC-Q200

## Applications

1. HDMI
2. DVI 、 Digital TVs 、 DVD recorders and LVDS.
3. Automotive

## Shape and Dimension

Unit: mm

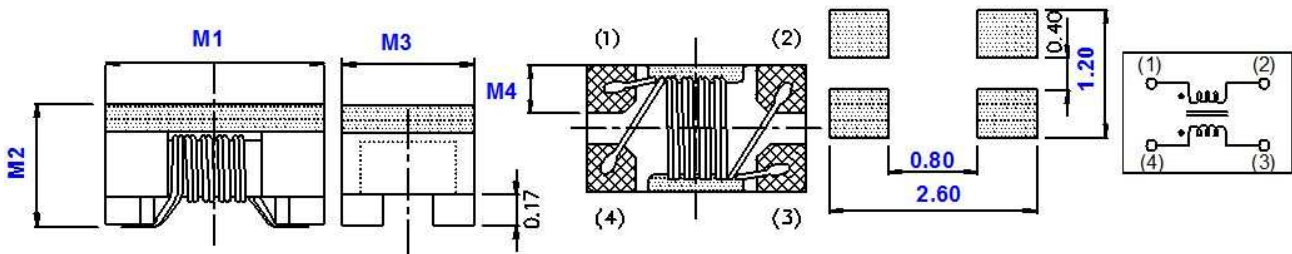

SERIES	M1	M2	M3	M4
WQCF2012FH	2.0±0.2	1.20±0.2	1.20±0.2	0.40(TYP.)

## Ordering Information

WQ	CF	2012	FH	M	670	P	B
<b>Product Code</b>	<b>Series</b>	<b>Dimensions</b>	<b>Series extension</b>	<b>Tolerance</b>	<b>Value</b>	<b>Packing Code</b>	
WQ: Inductor AEC-Q200	COMMON MODE CHOKE	2.0 * 1.2 mm	FH	M: ± 20%	670 = 67OHM 120 = 120OHM	P=7" Reeled (Embossed tape)	B:STD

## Electrical Characteristics

WQCF2012FH Series	Z (OHM) @100MHz ±20%	DCR MAX. (Ω)	RATE CURRENT (mA)	Cut-off Frequency (GHz) TYP.	Rated Voltage (Vdc)	Insulation Resistance (MOHM) MIN.
WQCF2012FHM670PB	67	0.25	400	6	50	10
WQCF2012FHM900PB	90	0.30	370			
WQCF2012FHM121PB	120	0.35	330			

### TEST INSTRUMENT

Z Tested by Agilent4291B+16193A

DCR Tested by Zentech502BC

Insulation Resistance Tested by Agilent 4338B

Operating Temperature Range: -40°C ~ +125°C

※MSL:LEVEL 1



## TYPICAL IMPEDANCE VS FREQUENCY

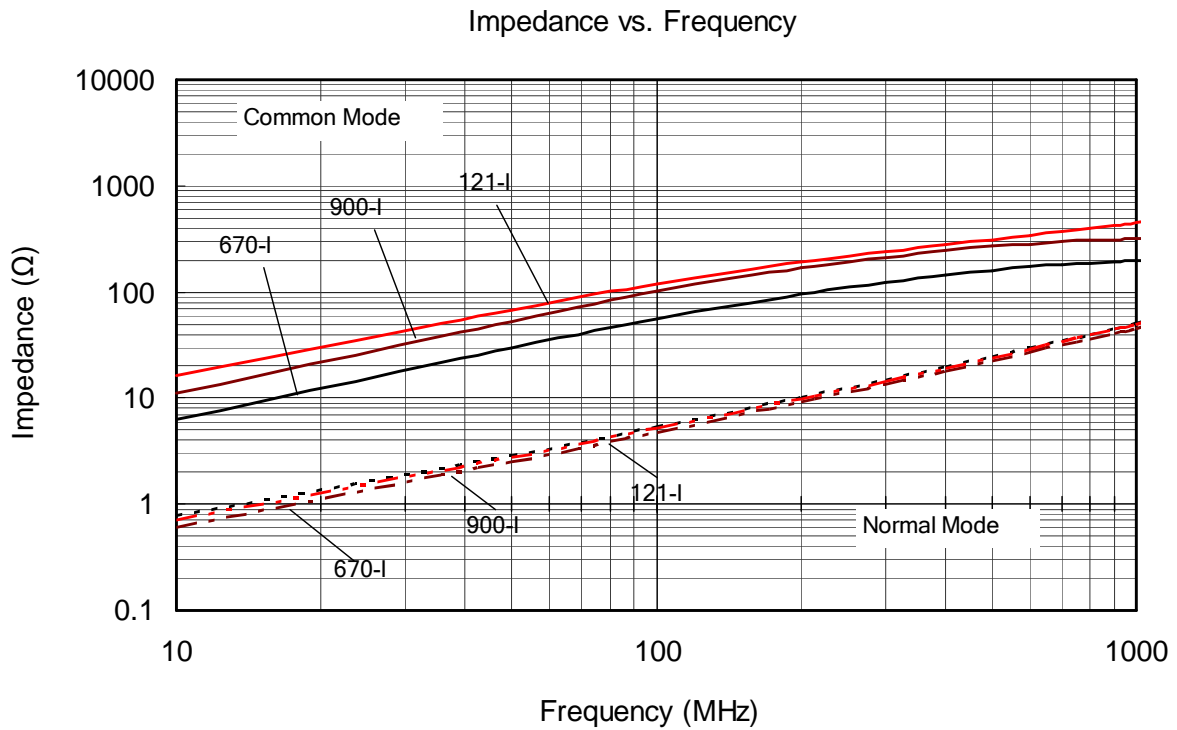

## TYPICAL RoHS REFLOW PROFILE

### Typical RoHS Reflow Profile

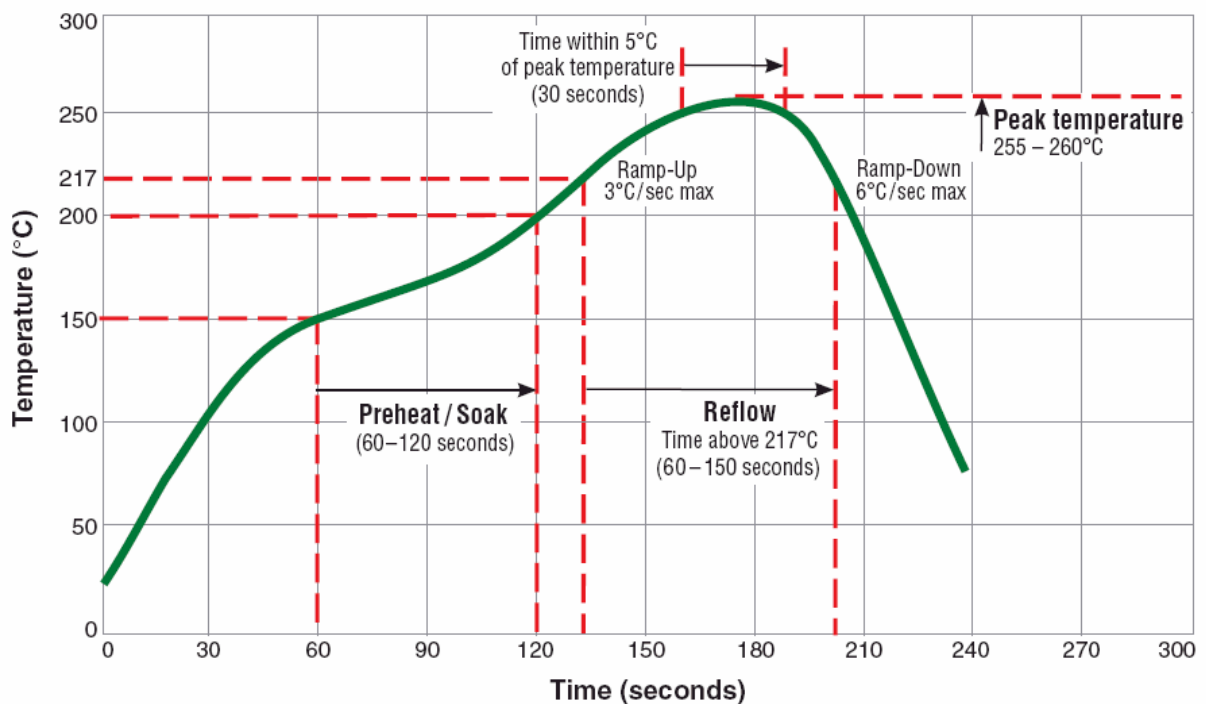

## RELIABILITY PERFORMANCE

Test Item	Test Condition	Standard Source
High Temperature Exposure (Storage)	1000 hrs. at rated operating temperature (e.g. 125°C part can be stored for 1000 hrs. @ 125°C. Same applies for 105°C and 85°C. Unpowered. Measurement at 24±4 hours after test conclusion.	MIL-STD-202 Method 108
Temperature Cycling	1000 cycles (-40°C to +125°C). Note: If 85°C part or 105°C part the 1000 cycles will be at that temperature. Measurement at 24±4 hours after test conclusion. 30min maximum dwell time at each temperature extreme. 1 min. maximum transition time.	JESD22 Method JA-104
Biased Humidity	1000 hours 85°C/85%RH. Unpowered. Measurement at 24±4 hours after test conclusion.	MIL-STD-202 Method 103
Operational Life	1000 hrs. @ 105°C. If 85°C or 125°C part will be tested at that temperature. Measurement at 24±4 hours after test conclusion.	MIL-PRF-27
Mechanical Shock	Method 213. Condition C, Peak Value: 100g's, Duration: 6ms, Waveform: Half-sine Velocity Change: 12.3ft/sec	MIL-STD-202 Method 213
Vibration	5g's for 20 minutes, 12 cycles each of 3 orientations. Note: Use 8"X5" PCB, .031" thick, 7 secure points on one long side and 2 secure points at corners of opposite sides. Parts mounted within 2" from any secure point. Test from 10-2000 Hz.	MIL-STD-202 Method 204
Resistance to Soldering Heat	Condition B No pre-heat of samples. Note: Single Wave Solder - Procedure 2 for SMD and Procedure 1 for Leaded with solder within 1.5mm of device body.	MIL-STD-202 Method 210
ESD	Passive Component Human Body Model (HBM) Electrostatic Discharge (ESD) Test. Only direct contact discharge, record the voltage value what the sample can pass.	AEC-Q200-002 Or ISO/DIS10605
Solderability	For both Leaded & SMD. Electrical Test not required. Magnification 50X. Conditions: Leaded: Method A @ 235°C, category 3. SMD: a) Method B, 4 hrs @ 155°C dry heat @ 235°C b) Method B @ 215°C category 3. c) Method D category 3 @ 260°C.	J-STD-002
Flammability	V-0 or V-1 Acceptable	UL-94
Board Flex	60 sec minimum holding time.	AEC-Q200-005
Terminal Strength (SMD)	Force of 900g for 60 seconds.	AEC-Q200-006

### Tape & Reel Packaging Dimensions:

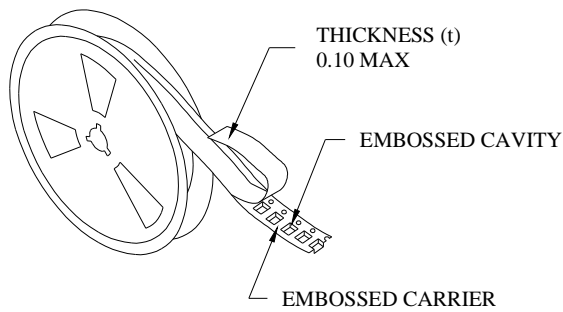

- THE FORCE FOR TEARING OFF COVER TAPE IS 10 TO 100 GRAMS IN THE ARROW DIRECTION.

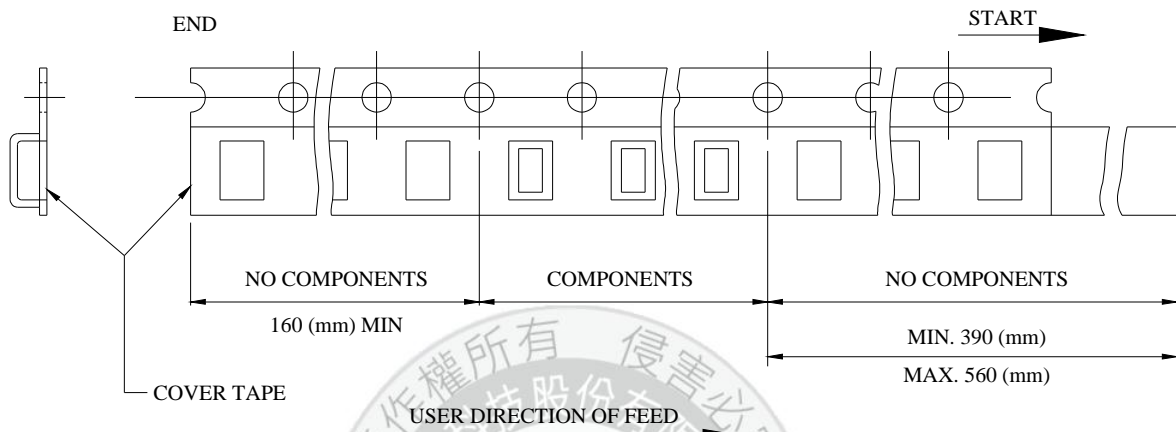
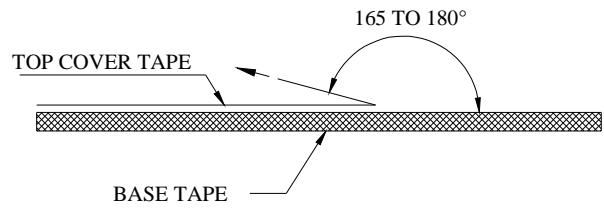

### ■ CARRIER TAPE REELS (mm)

MATERIAL: PLASTIC

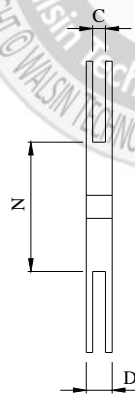
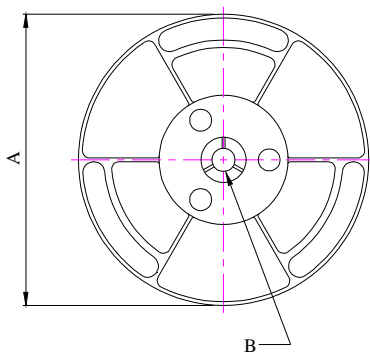

### ■ DIMENSIONS OF CARRIER TAPE (mm)

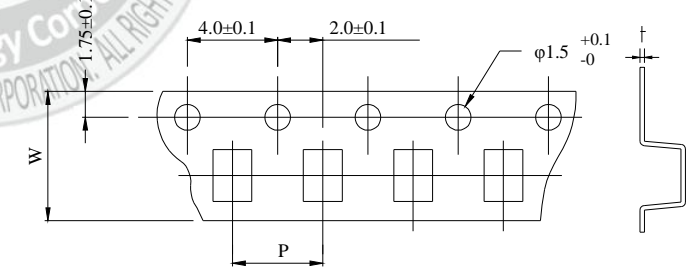

UNIT : mm

	A	B	C	D	N	P	W	t
DIM.	178	13.0	8.4	12.5	75	4.0	8.00	0.24
TOL.	±2.0	±0.8	+1.0-0	MAX	±1.5	±0.10	±0.20	±0.01

Quantity per reel : 2K pcs