



**Muffin XL - MD28B5 - 032105 - No**  
 (Family) (Model) (Part #) (In Stock)

## Electrical Specifications

Operating Voltage:	28 Volts
Voltage Range:	12 - 32 Volts
Power Supply:	6.5 Watts
Line Current:	0.23 Amps
Locked Rotor Current	1.12 Amps
Nominal Speed:	3100 RPM

## Mechanical Specifications

Dimensions:	4.7 x 4.7 x 1.5 in
Weight	21.52 oz
Max Airflow @ 0 in H <sub>2</sub> O	110.0 CFM
Max Pressure @ 0 CFM	0.278 in H <sub>2</sub> O
Noise	50.0 dBA



## Mechanical Drawing

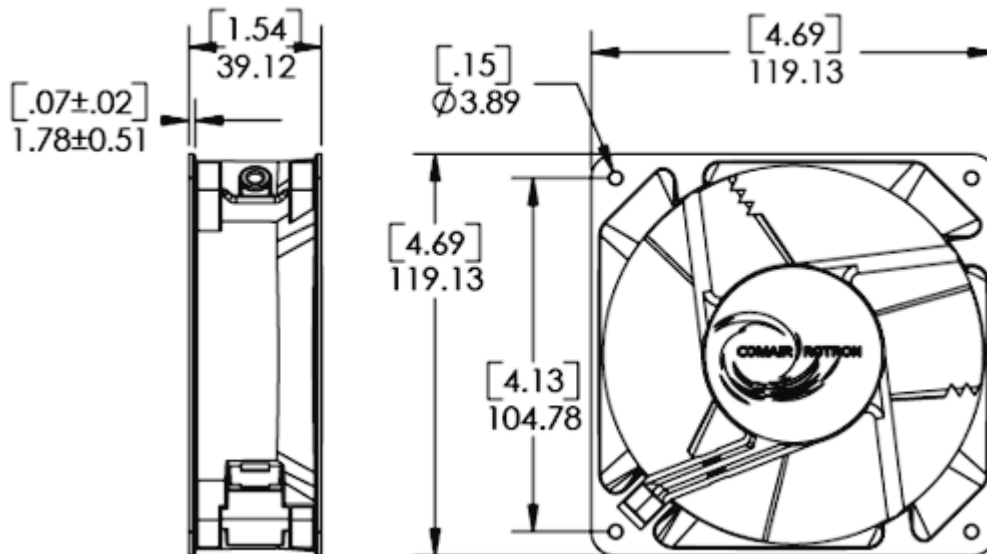

Comair Rotron, Inc.  
 Phone: 619.651.2000  
 sales@comairrotron.com

Comair Rotron Europe, Ltd.  
 Phone: +44.1527.520525  
 saleseurope@comairrotron.com

Comair Rotron Fan Company Ltd.  
 Phone: +86.21.52260581  
 salesasia@comairrotron.com

Print Date: Wednesday, November 10, 2010 at 10:07:04 - DC Fan Datasheet - Web Version 1.0 Rev. B



## Fan Performance Curve

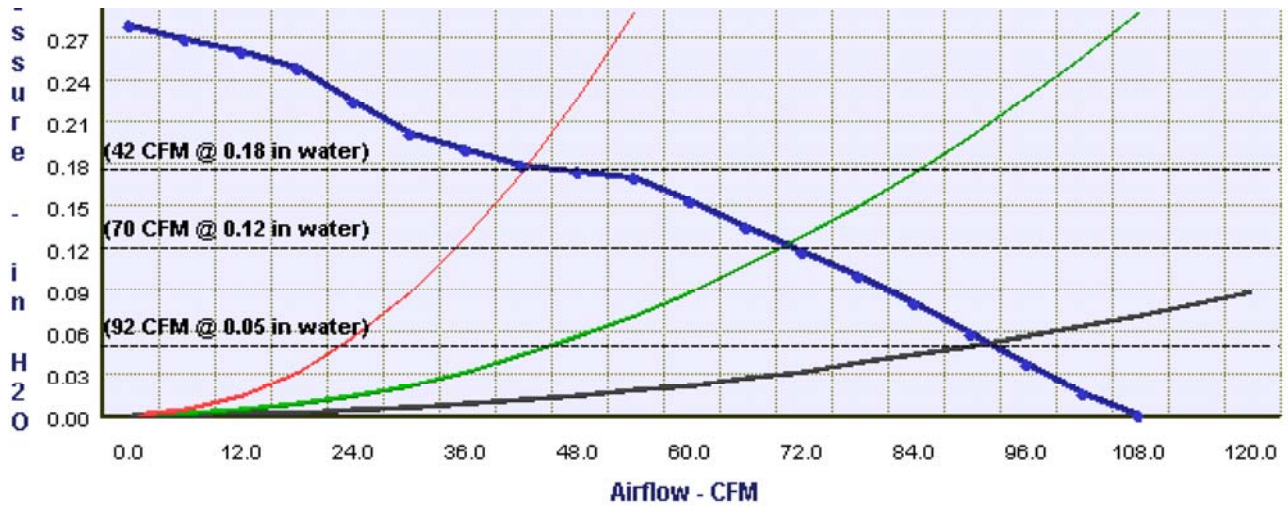

## Fan Configuration Options

**Muffin XL** (Family)    
 **MD28B5 / 032105** (Model)    
 **No** (In Stock)    
 **305 mm [12 inch] Leads** (Features)

**Fan Speed:** 3100 RPM    
**Fan Bearings:** Ball Bearings  
**Fan Airflow Direction:** Flow L (CW Rotation)    
**Fan Termination:** Leads

**Fan Monitoring Options:** TTL (+5V) Tachometer Output

**Fan Speed Control Option:** No ThermaPro-V Fan Speed Control Options Selected

**Environmental Protection Options:** No Enviroschild Options Selected

**Comair Rotron, Inc.**  
 Phone: 619.651.2000  
 sales@comairrotron.com

**Comair Rotron Europe, Ltd.**  
 Phone: +44.1527.520525  
 saleseurope@comairrotron.com

**Comair Rotron Fan Company Ltd.**  
 Phone: +86.21.52260581  
 salesasia@comairrotron.com

Print Date: Wednesday, November 10, 2010 at 10:07:04 - DC Fan Datasheet - Web Version 1.0 Rev. B



**Accessories** (Click on part number for detailed drawing.)

- 571064  
Plug and Cord



- 550113  
Mounting Clip

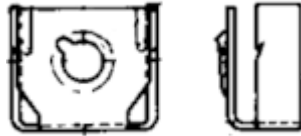

- 551590  
Filter Assembly

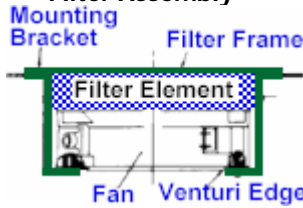

- 554148  
Filter Guard Assembly

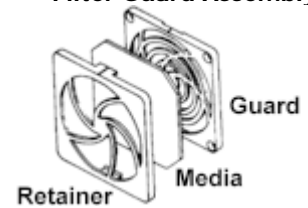

- 552934  
Finger Guard



- 476042  
Finger Guard

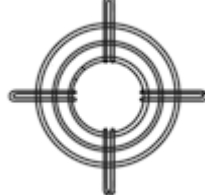

- 550481  
Finger Guard

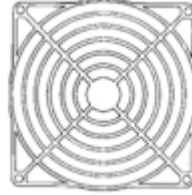

- 551147  
Finger Guard

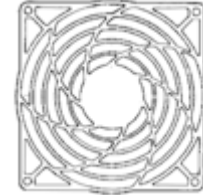

Comair Rotron, Inc.  
Phone: 619.651.2000  
sales@comairrotron.com

Comair Rotron Europe, Ltd.  
Phone: +44.1527.520525  
saleseurope@comairrotron.com

Comair Rotron Fan Company Ltd.  
Phone: +86.21.52260581  
salesasia@comairrotron.com

Print Date: Wednesday, November 10, 2010 at 10:07:04 - DC Fan Datasheet - Web Version 1.0 Rev. B