

### Dimensions: [mm]

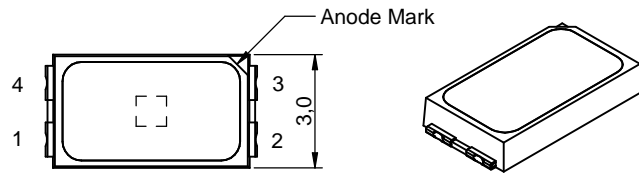

Scale - 5:1

### Recommended Land Pattern: [mm]

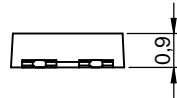
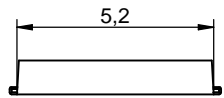
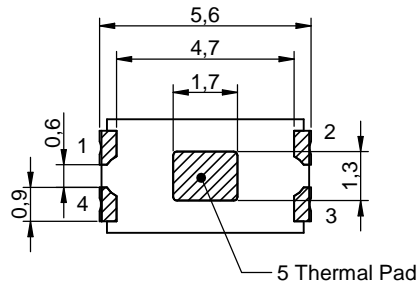
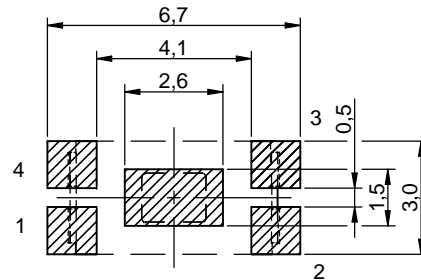

Scale - 5:1

### Schematic:

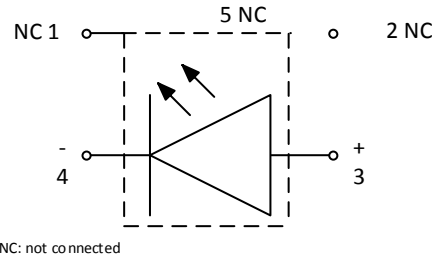

### Absolute Maximum Ratings (Ambient Temperature 25°C):

| Properties   |                 | Test conditions  | Value | Unit |
|--|-----------------|------------------|-------|------|
| Power Dissipation                                    | $P_{Diss}$      |                  | 510   | mW   |
| Peak Forward Current                                 | $I_{F Peak}$    | duty/ 10 @ 1 kHz | 300   | mA   |
| Continuous Forward Current                           | $I_F$           |                  | 180   | mA   |
| Reverse Voltage                                      | $V_{REV}$       |                  | 5     | V    |
| ESD Threshold/ Human Body Model                      | $V_{ESD HBM}$   |                  | 2000  | V    |
| Absolute Thermal Resistance Junction to Solder Point | $R_{\theta JS}$ |                  | 35    | K/W  |
| Junction Temperature                                 | $T_J$           |                  | 130   | °C   |

### Optical Properties:

|                 |          |
|-----------------|----------|
| Chip Technology | InGaN    |
| Emitting Color  | Daylight |
| Lens Type       | Top LED  |

### General Information:

|  |                     |
|--|---------------------|
| Operating Temperature                      | -40 up to +85 °C    |
| Storage Conditions (in original packaging) | < 40 °C ; < 90 % RH |
| Storage Conditions (for single parts)      | -40 up to +85 °C    |
| Moisture Sensitivity Level (MSL)           | 3                   |



Würth Elektronik eiSos GmbH & Co. KG  
EMC & Inductive Solutions  
Max-Eyth-Str. 1  
74638 Waldenburg  
Germany  
Tel. +49 (0) 79 42 945 - 0  
www.we-online.com  
eiSos@we-online.com

|   |                        |                                 |                                      |                       |
|---|------------------------|---------------------------------|--------------------------------------|-----------------------|
| CHECKED<br>ZAn  | REVISION<br>003.000    | DATE (YYYY-MM-DD)<br>2021-07-01 | GENERAL TOLERANCE<br>DIN ISO 2768-1m | PROJECTION METHOD<br> |
| DESCRIPTION<br><b>WL-SWTP SMT White Top view<br/>PLCC</b> |                        |                                 | ORDER CODE<br><b>158563450</b>       |                       |
| SIZE/TYPE<br>5630   | BUSINESS UNIT<br>eiPal | STATUS<br>Valid                 | PAGE<br>1/10                         |                       |

## Electrical & Optical Properties:

| Properties                   | Test conditions         | Value |        |      | Unit    |
|------------------------------|-------------------------|-------|--------|------|---------|
|                              |                         | min.  | typ.   | max. |         |
| Chromaticity Coordinate X    | $c_x$ 100 mA            |       | 0.3387 |      |         |
| Chromaticity Coordinate Y    | $c_y$ 100 mA            |       | 0.3459 |      |         |
| Luminous Flux                | $\Phi_V$ 100 mA         | 30    | 39     |      | lm      |
| Forward Voltage              | $V_F$ 100 mA            |       | 3      | 3.5  | V       |
| Correlated Color Temperature | CCT 100 mA              |       | 5000   |      | K       |
| Reverse Current              | $I_{REV}$ 5 V           |       |        | 5    | $\mu A$ |
| Color Rendering Index        | CRI 100 mA              | 80    | 85     |      |         |
| Viewing Angle Phi 0°         | $2\theta_{50\%}$ 100 mA |       | 120    |      | °       |

## Certification:

|                |                                     |
|----------------|-------------------------------------|
| RoHS Approval  | Compliant [2011/65/EU&2015/863]     |
| REACH Approval | Conform or declared [(EC)1907/2006] |
| Halogen Free   | Conform [JEDEC JS709B]              |
| Halogen Free   | Conform [IEC 61249-2-21]            |

## Viewing Angle:

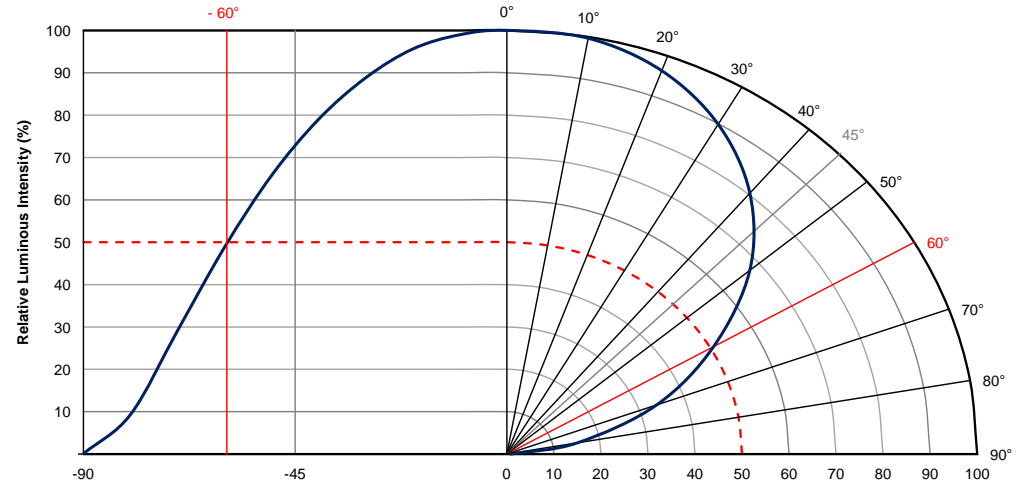

|  |   |                        |                                 |                                      |                       |
|--|---|------------------------|---------------------------------|--------------------------------------|-----------------------|
|  | CHECKED<br>ZAn  | REVISION<br>003.000    | DATE (YYYY-MM-DD)<br>2021-07-01 | GENERAL TOLERANCE<br>DIN ISO 2768-1m | PROJECTION METHOD<br> |
|  | DESCRIPTION<br><b>WL-SWTP SMT White Top view<br/>PLCC</b> |                        |                                 |                                      |                       |
|  | ORDER CODE<br><b>158563450</b>                            |                        |                                 |                                      |                       |
|  | SIZE/TYPE<br>5630   | BUSINESS UNIT<br>eiPal | STATUS<br>Valid                 | PAGE<br>2/10                         |                       |

### Spectral:

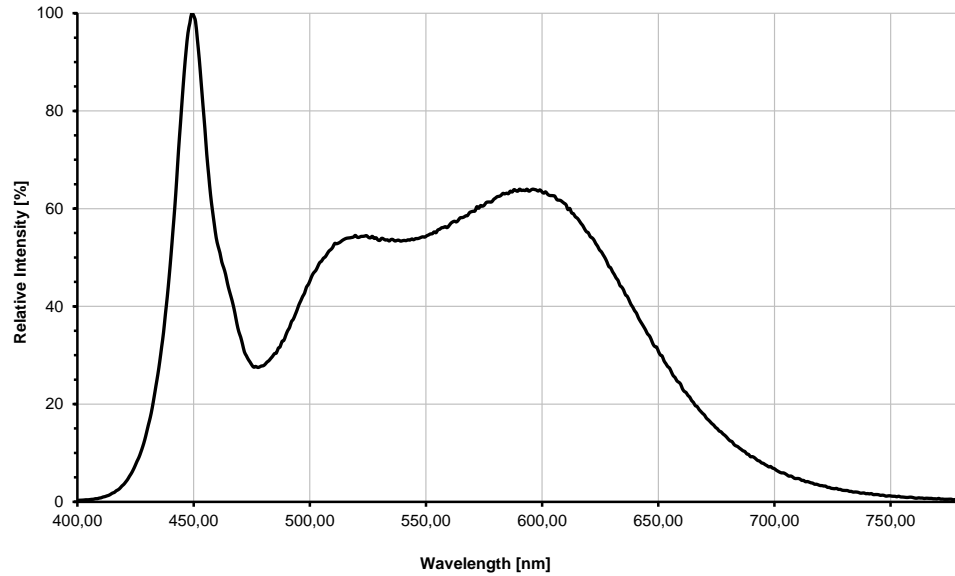

### Forward Current vs. Forward Voltage:

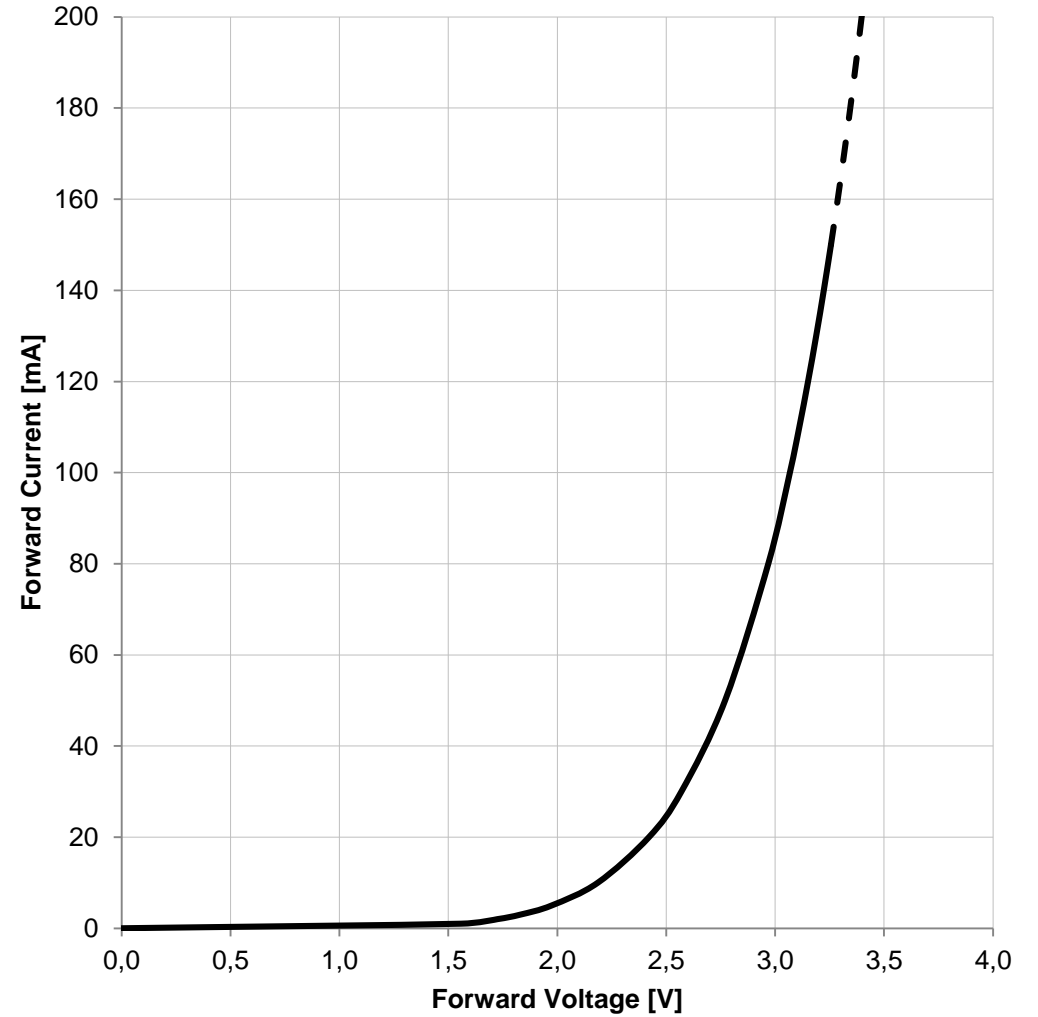

Würth Elektronik eiSos GmbH & Co. KG  
 EMC & Inductive Solutions  
 Max-Eyth-Str. 1  
 74638 Waldenburg  
 Germany  
 Tel. +49 (0) 79 42 945 - 0  
 www.we-online.com  
 eiSos@we-online.com

|   |                        |                                 |                                      |                       |
|---|------------------------|---------------------------------|--------------------------------------|-----------------------|
| CHECKED<br>ZAn  | REVISION<br>003.000    | DATE (YYYY-MM-DD)<br>2021-07-01 | GENERAL TOLERANCE<br>DIN ISO 2768-1m | PROJECTION METHOD<br> |
| DESCRIPTION<br><b>WL-SWTP SMT White Top view<br/>PLCC</b> |                        |                                 | ORDER CODE<br><b>158563450</b>       |                       |
| SIZE/TYPE<br>5630   | BUSINESS UNIT<br>eiPal | STATUS<br>Valid                 | PAGE<br>3/10                         |                       |

### Luminous Intensity vs. Forward Current:

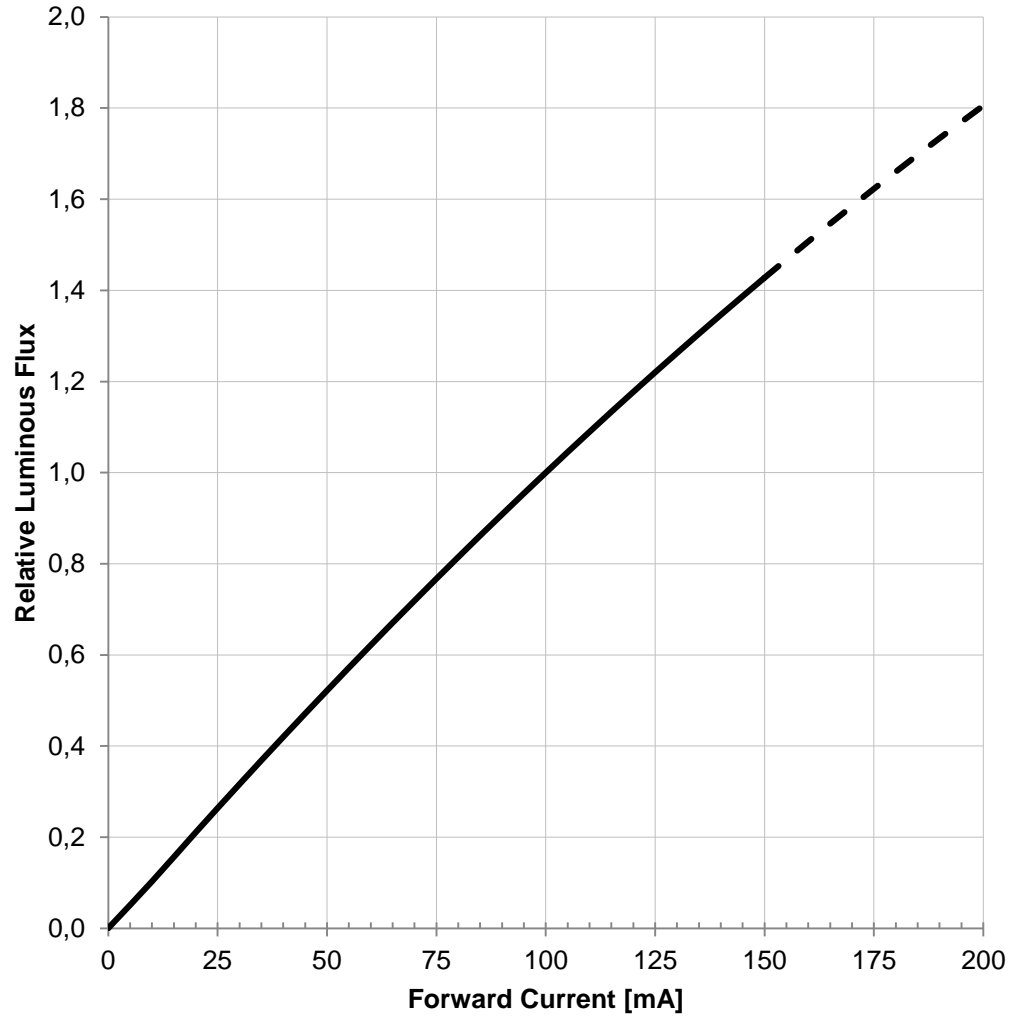

### Derating Curve:

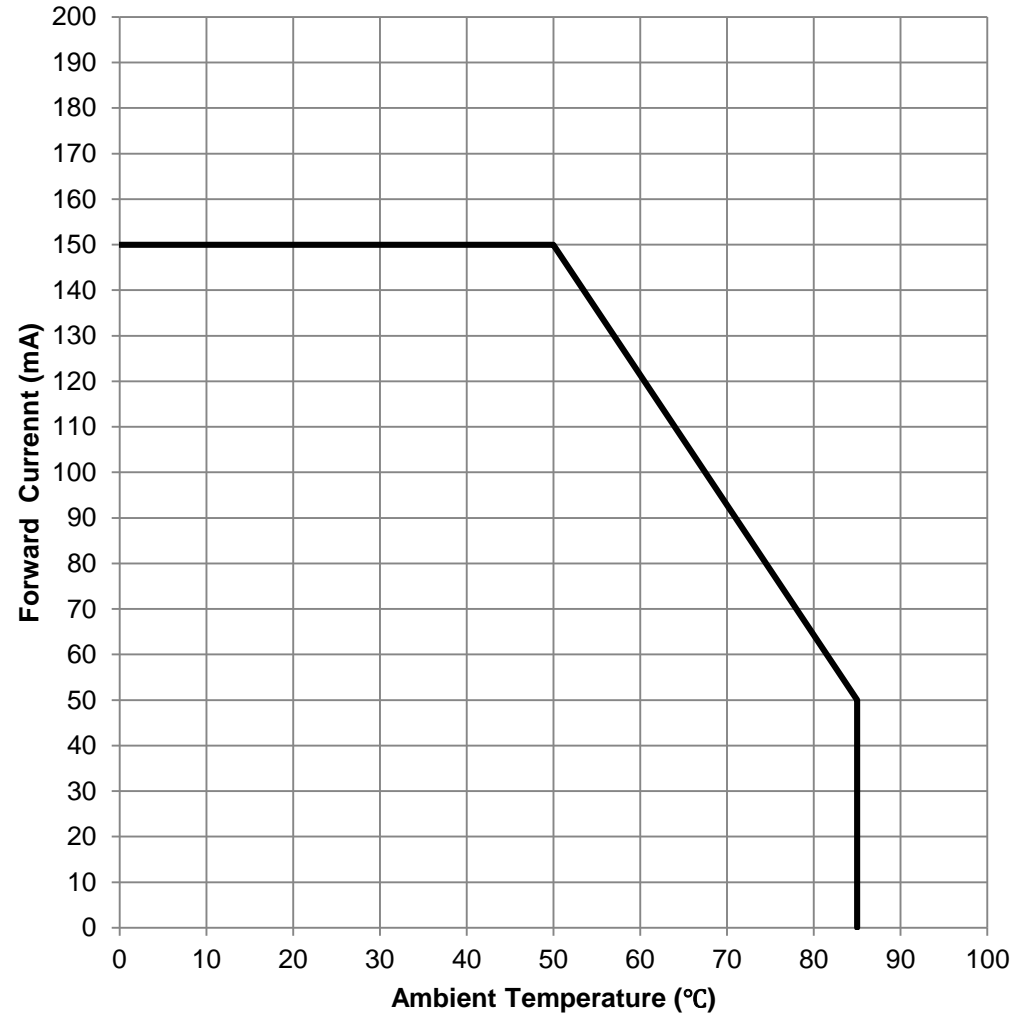

Würth Elektronik eiSos GmbH & Co. KG  
 EMC & Inductive Solutions  
 Max-Eyth-Str. 1  
 74638 Waldenburg  
 Germany  
 Tel. +49 (0) 79 42 945 - 0  
 www.we-online.com  
 eiSos@we-online.com

|   |                        |                                 |                                      |                       |
|---|------------------------|---------------------------------|--------------------------------------|-----------------------|
| CHECKED<br>ZAn  | REVISION<br>003.000    | DATE (YYYY-MM-DD)<br>2021-07-01 | GENERAL TOLERANCE<br>DIN ISO 2768-1m | PROJECTION METHOD<br> |
| DESCRIPTION<br><b>WL-SWTP SMT White Top view<br/>PLCC</b> |                        |                                 | ORDER CODE<br><b>158563450</b>       |                       |
| SIZE/TYPE<br>5630   | BUSINESS UNIT<br>eiPal | STATUS<br>Valid                 | PAGE<br>4/10                         |                       |

This electronic component has been designed and developed for usage in general electronic equipment only. This product is not authorized for use in equipment where a higher safety standard and reliability standard is especially required or where a failure of the product is reasonably expected to cause severe personal injury or death, unless the parties have executed an agreement specifically governing such use. Moreover Würth Elektronik eiSos GmbH & Co KG products are neither designed nor intended for use in areas such as military, aerospace, aviation, nuclear control, submarine, transportation (automotive control, train control, ship control), transportation signal, disaster prevention, medical, public information network etc.. Würth Elektronik eiSos GmbH & Co KG must be informed about the intent of such usage before the design-in stage. In addition, sufficient reliability evaluation checks for safety must be performed on every electronic component which is used in electrical circuits that require high safety and reliability functions or performance.

### Chromaticity diagram:

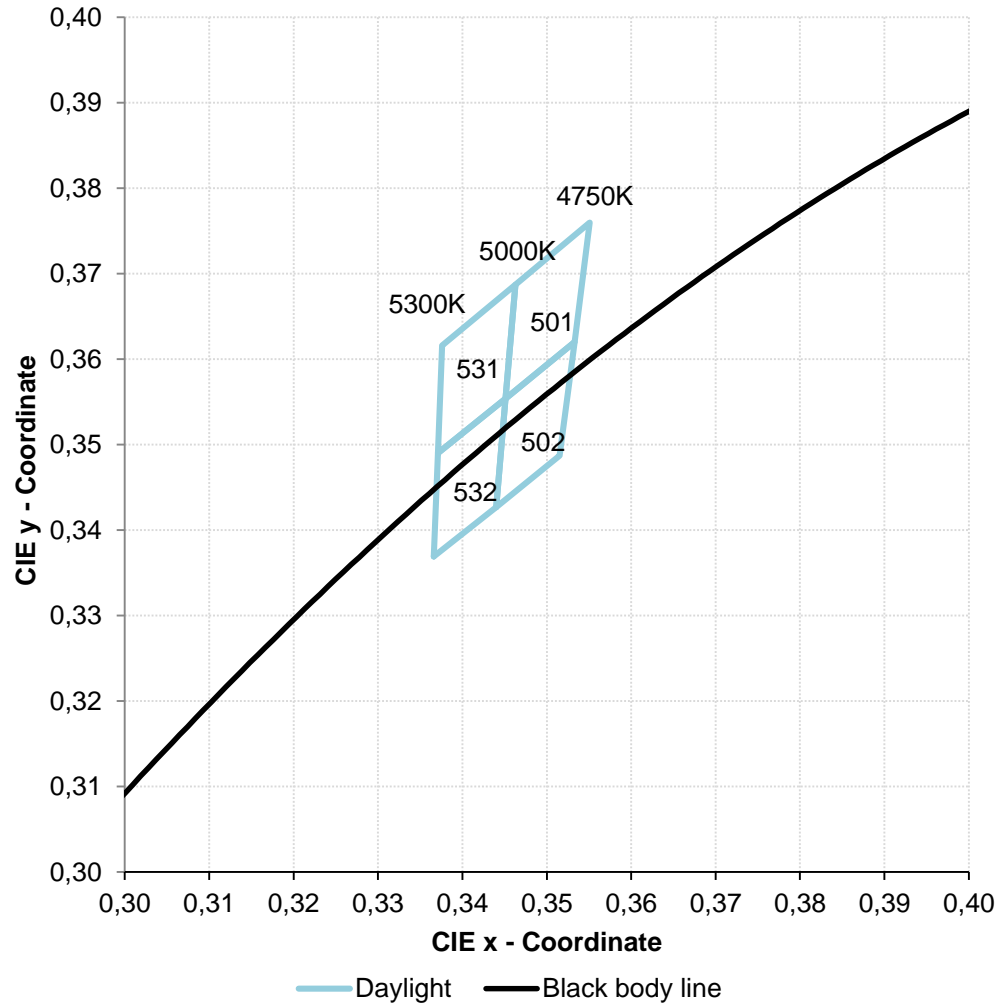

### Chromaticity Properties:

| Bin groups from 4750K to 5000K | Cx     | Cy     | Bin groups from 5000K to 5300K | Cx     | Cy     |
|--------------------------------|--------|--------|--------------------------------|--------|--------|
|                                | 0,3451 | 0,3554 |                                | 0,3371 | 0,349  |
|                                | 0,3463 | 0,3687 |                                | 0,3376 | 0,3616 |
| 501                            | 0,3551 | 0,376  | 531                            | 0,3463 | 0,3687 |
|                                | 0,3533 | 0,362  |                                | 0,3451 | 0,3554 |
|                                | 0,3451 | 0,3554 |                                | 0,3371 | 0,349  |
|                                |        |        |                                |        |        |
|                                | 0,344  | 0,3427 |                                | 0,3366 | 0,3369 |
|                                | 0,3451 | 0,3554 |                                | 0,3371 | 0,349  |
| 502                            | 0,3533 | 0,362  | 532                            | 0,3451 | 0,3554 |
|                                | 0,3515 | 0,3487 |                                | 0,344  | 0,3427 |
|                                | 0,344  | 0,3427 |                                | 0,3366 | 0,3369 |

|                   |   |          |   |                   |                                |
|-------------------|---|----------|---|-------------------|--------------------------------|
|                   | CHECKED   | REVISION | DATE (YYYY-MM-DD)   | GENERAL TOLERANCE | PROJECTION METHOD              |
|                   | ZAn   | 003.000  | 2021-07-01  | DIN ISO 2768-1m   |                                |
|                   | DESCRIPTION<br><b>WL-SWTP SMT White Top view</b><br><b>PLCC</b> |          |   |                   | ORDER CODE<br><b>158563450</b> |
|                   |   |          | WÜRTH ELEKTRONIK eISos GmbH & Co. KG<br>EMC & Inductive Solutions<br>Max-Eyth-Str. 1<br>74638 Waldenburg<br>Germany<br>Tel. +49 (0) 79 42 945 - 0<br>www.we-online.com<br>eiSos@we-online.com |                   | BUSINESS UNIT<br>eiPal         |
| SIZE/TYPE<br>5630 |   |          | STATUS<br>Valid   | PAGE<br>5/10      |                                |

This electronic component has been designed and developed for usage in general electronic equipment only. This product is not authorized for use in equipment where a higher safety standard and reliability standard is especially required or where a failure of the product is reasonably expected to cause severe personal injury or death, unless the parties have executed an agreement specifically governing such use. Moreover Würth Elektronik eiSos GmbH & Co KG products are neither designed nor intended for use in areas such as military, aerospace, aviation, nuclear control, submarine, transportation (automotive control, train control, ship control), transportation signal, disaster prevention, medical, public information network etc. Würth Elektronik eiSos GmbH & Co KG must be informed about the intent of such usage before the design-in stage. In addition, sufficient reliability evaluation checks for safety must be performed on every electronic component which is used in electrical circuits that require high safety and reliability functions or performance.

# Packaging Specification - Tape and Reel: [mm]

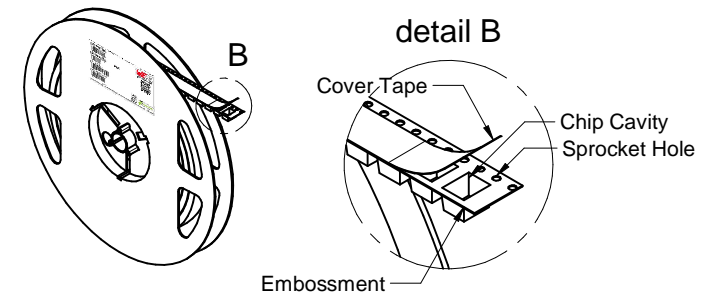
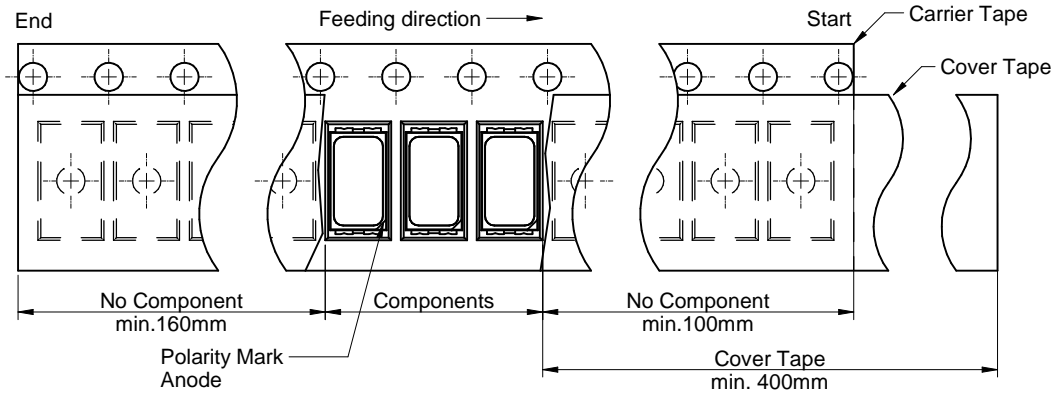
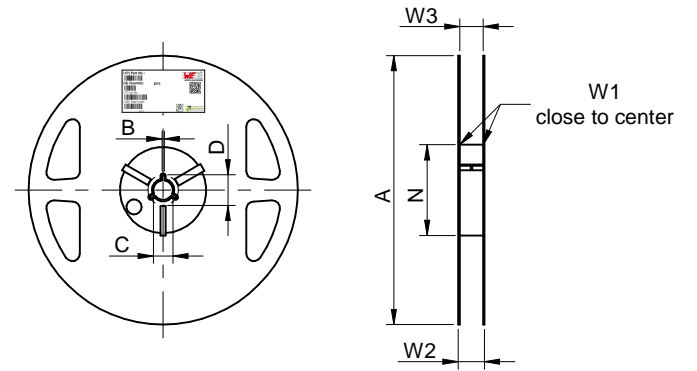
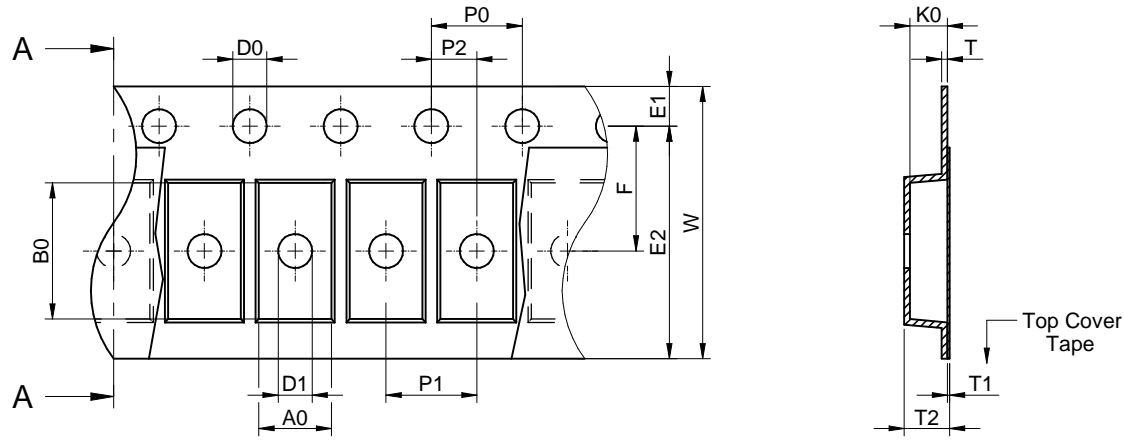

packaging is referred to the international standard IEC 60286-3:2013

|           | Tape Type | A0 (mm) | B0 (mm) | W (mm)    | T (mm) | T1 (mm) | T2 (mm) | K0 (mm) | P0 (mm) | P1 (mm) | P2 (mm) | D0 (mm)   | D1 (mm) | E1 (mm) | E2 (mm) | F (mm) | Material    | Qty. (pcs.) |
|-----------|-----------|---------|---------|-----------|--------|---------|---------|---------|---------|---------|---------|-----------|---------|---------|---------|--------|-------------|-------------|
| Tolerance |           | typ.    | typ.    | +0,3/-0,1 | ref.   | ref.    | typ.    | typ.    | ±0,1    | ±0,1    | ±0,05   | +0,1/-0,0 | min.    | ±0,1    | min.    | ±0,05  |             |             |
| Value     | 2a        | 3,20    | 6,00    | 12,00     | 0,25   | 0,10    | 1,30    | 1,10    | 4,00    | 4,00    | 2,00    | 1,50      | 1,50    | 1,75    | 10,25   | 5,50   | Polystyrene | 2000        |

|            | A     | B      | C    | D     | N     | W1    | W2    | W3    | W3          |
|------------|-------|--------|------|-------|-------|-------|-------|-------|-------------|
| Tolerance  | ± 2,0 | min.   | min. | min.  | min.  | + 2,0 | max.  | min.  | max.        |
| Tape width | 12 mm | 178,00 | 1,50 | 12,80 | 20,20 | 50,00 | 12,40 | 18,40 | 11,90 15,40 |

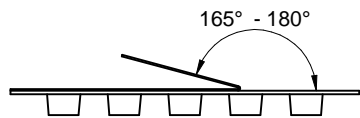

|            |       |                      |
|------------|-------|----------------------|
|            |       | <b>Pull-of force</b> |
| Tape width | 12 mm | 0,1 N - 1,3 N        |



Würth Elektronik eiSos GmbH & Co. KG  
 EMC & Inductive Solutions  
 Max-Eyth-Str. 1  
 74638 Waldenburg  
 Germany  
 Tel. +49 (0) 79 42 945 - 0  
 www.we-online.com  
 eiSos@we-online.com

|   |                        |                                 |                                      |                       |
|---|------------------------|---------------------------------|--------------------------------------|-----------------------|
| CHECKED<br>ZAn  | REVISION<br>003.000    | DATE (YYYY-MM-DD)<br>2021-07-01 | GENERAL TOLERANCE<br>DIN ISO 2768-1m | PROJECTION METHOD<br> |
| DESCRIPTION<br><b>WL-SWTP SMT White Top view<br/>PLCC</b> |                        |                                 | ORDER CODE<br><b>158563450</b>       |                       |
| SIZE/TYPE<br>5630   | BUSINESS UNIT<br>eiPal | STATUS<br>Valid                 | PAGE<br>6/10                         |                       |

This electronic component has been designed and developed for usage in general electronic equipment only. This product is not authorized for use in equipment where a higher safety standard and reliability standard is especially required or where a failure of the product is reasonably expected to cause severe personal injury or death, unless the parties have executed an agreement specifically governing such use. Moreover Würth Elektronik eiSos GmbH & Co KG products are neither designed nor intended for use in areas such as military, aerospace, aviation, nuclear control, submarine, transportation (automotive control, train control, ship control), transportation signal, disaster prevention, medical, public information network etc. Würth Elektronik eiSos GmbH & Co KG must be informed about the intent of such usage before the design-in stage. In addition, sufficient reliability evaluation checks for safety must be performed on every electronic component which is used in electrical circuits that require high safety and reliability functions or performance.

### Classification Reflow Profile for SMT components:

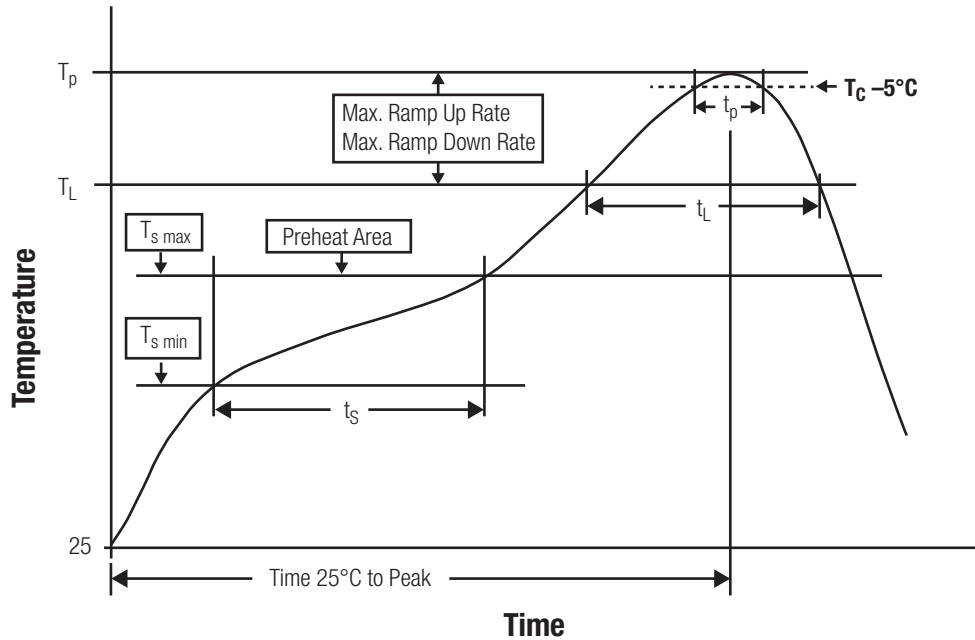

### Classification Reflow Soldering Profile:

| Profile Feature  |                     | Value                            |
|--|---------------------|----------------------------------|
| Preheat Temperature Min  | $T_{s \text{ min}}$ | 150 °C                           |
| Preheat Temperature Max  | $T_{s \text{ max}}$ | 200 °C                           |
| Preheat Time $t_s$ from $T_{s \text{ min}}$ to $T_{s \text{ max}}$ | $t_s$               | max. 60 - 120 seconds            |
| Ramp-up Rate ( $T_L$ to $T_p$ )                                    |                     | 3 °C/ second max.                |
| Liquidous Temperature  | $T_L$               | 217 °C                           |
| Time $t_L$ maintained above $T_L$                                  | $t_L$               | max. 60 seconds                  |
| Peak package body temperature                                      | $T_p$               | $T_p \leq T_c$ , see Table below |
| Time within 5°C of actual peak temperature                         | $t_p$               | max. 10 seconds                  |
| Ramp-down Rate ( $T_p$ to $T_L$ )                                  |                     | 6 °C/ second max.                |
| Time 25°C to peak temperature                                      |                     | max. 220 seconds                 |

refer to IPC/ JEDEC J-STD-020E

### Package Classification Reflow Temperature ( $T_c$ ):

| Properties   | Volume mm <sup>3</sup> <350 | Volume mm <sup>3</sup> 350-2000 | Volume mm <sup>3</sup> >2000 |
|--|-----------------------------|---------------------------------|------------------------------|
| PB-Free Assembly   Package Thickness < 1.6 mm        | 260 °C                      | 260 °C                          | 260 °C                       |
| PB-Free Assembly   Package Thickness 1.6 mm - 2.5 mm | 260 °C                      | 250 °C                          | 245 °C                       |
| PB-Free Assembly   Package Thickness > 2.5 mm        | 250 °C                      | 245 °C                          | 245 °C                       |
| Applied cycles                                       | 2 cycles max.               |                                 |                              |

refer to IPC/ JEDEC J-STD-020E

|  |  |               |                   |                   |                   |
|--|--|---------------|-------------------|-------------------|-------------------|
|  | CHECKED  | REVISION      | DATE (YYYY-MM-DD) | GENERAL TOLERANCE | PROJECTION METHOD |
|  | ZAn  | 003.000       | 2021-07-01        | DIN ISO 2768-1m   |                   |
|  | DESCRIPTION                                      |               |                   |                   | ORDER CODE        |
|  | <b>WL-SWTP SMT White Top view</b><br><b>PLCC</b> |               |                   |                   | <b>158563450</b>  |
|  | SIZE/TYPE  | BUSINESS UNIT | STATUS            | PAGE              |                   |
|  | 5630   | eiPal         | Valid             | 7/10              |                   |

This electronic component has been designed and developed for usage in general electronic equipment only. This product is not authorized for use in equipment where a higher safety standard and reliability standard is especially required or where a failure of the product is reasonably expected to cause severe personal injury or death, unless the parties have executed an agreement specifically governing such use. Moreover Würth Elektronik eiSos GmbH & Co KG products are neither designed nor intended for use in areas such as military, aerospace, aviation, nuclear control, submarine, transportation (automotive control, train control, ship control), transportation signal, disaster prevention, medical, public information network etc... Würth Elektronik eiSos GmbH & Co KG must be informed about the intent of such usage before the design-in stage. In addition, sufficient reliability evaluation checks for safety must be performed on every electronic component which is used in electrical circuits that require high safety and reliability functions or performance.

## Cautions and Warnings:

### The following conditions apply to all goods within the product series of Optoelectronic Components of Würth Elektronik eiSos GmbH & Co. KG:

#### General:

- This optoelectronic component is designed and manufactured for use in general electronic equipment.
- Würth Elektronik must be asked for written approval (following the PPAP procedure) before incorporating the components into any equipment in fields such as military, aerospace, aviation, nuclear control, submarine, transportation (automotive control, train control, ship control), transportation signal, disaster prevention, medical, public information network, etc. where higher safety and reliability are especially required and/or if there is the possibility of direct damage or human injury.
- Optoelectronic components that will be used in safety-critical or high-reliability applications, should be pre-evaluated by the customer.
- The optoelectronic component is designed and manufactured to be used within the datasheet specified values. If the usage and operation conditions specified in the datasheet are not met, the wire insulation may be damaged or dissolved.
- Do not drop or impact the components, the component may be damaged
- Würth Elektronik products are qualified according to international standards, which are listed in each product reliability report. Würth Elektronik does not warrant any customer qualified product characteristics beyond Würth Elektronik's specifications, for its validity and sustainability over time.
- The responsibility for the applicability of the customer specific products and use in a particular customer design is always within the authority of the customer. All technical specifications for standard products also apply to customer specific products.
- Unless Würth Elektronik has given its express consent, the customer is under no circumstances entitled to reverse engineer, disassemble or otherwise attempt to extract knowledge or design information from the optoelectronic component

#### Product specific:

#### Soldering:

- The solder profile must comply with the technical product specifications. All other profiles will void the warranty.
- All other soldering methods are at the customers' own risk.
- The soldering pad pattern shown above is a general recommendation for the easy assembly of optoelectronic component. If a high degree of precision is required for the selected application (i.e. high density assembly), the customer must ensure that the soldering pad pattern is optimized accordingly.

#### Cleaning and Washing:

- Washing agents used during the production to clean the customer application might damage or change the characteristics of the optoelectronic component body, marking or plating. Washing agents may have a negative effect on the long-term functionality of the product.

- Using a brush during the cleaning process may break the optoelectronic component body. Therefore, we do not recommend using a brush during the PCB cleaning process.

#### Potting:

- If the product is potted in the customer application, the potting material might shrink or expand during and after hardening. Shrinking could lead to an incomplete seal, allowing contaminants into the optoelectronic component body, pins or termination. Expansion could damage the components. We recommend a manual inspection after potting to avoid these effects.

#### Storage Conditions:



- A storage of Würth Elektronik products for longer than 12 months is not recommended. Within other effects, the terminals may suffer degradation, resulting in bad solderability. Therefore, all products shall be used within the period of 12 months based on the day of shipment.
- Do not expose the optoelectronic component to direct sunlight.
- The storage conditions in the original packaging are defined according to DIN EN 61760-2.
- For a moisture sensitive component, the storage condition in the original packaging is defined according to IPC/JEDEC-J-STD-033. It is also recommended to return the optoelectronic component to the original moisture proof bag and reseal the moisture proof bag again.
- The storage conditions stated in the original packaging apply to the storage time and not to the transportation time of the components.

#### Packaging:

- The packaging specifications apply only to purchase orders comprising whole packaging units. If the ordered quantity exceeds or is lower than the specified packaging unit, packaging in accordance with the packaging specifications cannot be ensured.

#### Handling:

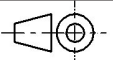
- Violation of the technical product specifications such as exceeding the nominal rated current, will void the warranty.
- The product design may influence the automatic optical inspection.
- Certain optoelectronic component surfaces consist of soft material. Pressure on the top surface has to be handled carefully to prevent negative influence to the function and reliability of the optoelectronic components.
- ESD prevention methods need to be applied for manual handling and processing by machinery.
- Resistors for protection are obligatory.
- Luminaires in operation may harm human vision or skin on a photo-biological level. Therefore direct light impact shall be avoided.
- In addition to optoelectronic components testing, products incorporating these devices have to comply with the safety precautions given in IEC 60825-1, IEC 62471 and IEC 62778
- Please be aware that Products provided in bulk packaging may get bent and might lead to derivations from the mechanical manufacturing tolerances mentioned in our datasheet, which is not considered to be a material defect.

|  |   |               |                   |                   |                   |   |                  |
|--|---|---------------|-------------------|-------------------|-------------------|---|------------------|
|  | CHECKED   | REVISION      | DATE (YYYY-MM-DD) | GENERAL TOLERANCE | PROJECTION METHOD |  |                  |
|  | ZAn   | 003.000       | 2021-07-01        | DIN ISO 2768-1m   |                   |   |                  |
|  | DESCRIPTION   |               |                   |                   |                   |   | ORDER CODE       |
|  | Würth Elektronik eiSos GmbH & Co. KG<br>EMC & Inductive Solutions<br>Max-Eyth-Str. 1<br>74638 Waldenburg<br>Germany<br>Tel. +49 (0) 79 42 945 - 0<br>www.we-online.com<br>eiSos@we-online.com |               |                   |                   |                   | <b>WL-SWTP SMT White Top view</b><br><b>PLCC</b>                                      | <b>158563450</b> |
|  | SIZE/TYPE   | BUSINESS UNIT | STATUS            | PAGE              |                   |   |                  |
| 5630   | eiPal   | Valid         | 8/10              |                   |                   |   |                  |





## Technical specification:

- The typical and/or calculated values and graphics of technical parameters can only reflect statistical figures. The actual parameters of each single product, may differ from the typical and/or calculated values or the typical characteristic line.
- On each reel, only one bin is sorted and taped. The bin is defined on intensity, chromaticity coordinate or wavelength and forward voltage.
- In order to ensure highest availability, the reel binning of standard deliveries can vary. A single bin cannot be ordered. Please contact us in advance, if you need a particular bin sorting before placing your order.
- Test conditions are measured at the typical current with pulse duration < 30ms. •Optical properties are measured according the CIE 127:2007 standard. •Wavelength tolerance under measurement conditions  $\pm 2\text{nm}$ . •Optical intensity tolerance under measurement conditions  $\pm 15\%$ . •Forward voltage tolerance under measurement conditions  $\pm 0.1\text{V}$ . •CCT tolerance of x and y coordinate of  $\pm 0.01$  and CRI tolerance of  $\pm 2$  is allowed

In the characteristics curves, all values given in dotted lines may show a higher deviation than the parameters mentioned above.

These cautions and warnings comply with the state of the scientific and technical knowledge and are believed to be accurate and reliable. However, no responsibility is assumed for inaccuracies or incompleteness.

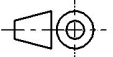
The customer has the sole responsibility to ensure that he uses the latest version of this datasheet, which is available on Würth Elektronik's homepage. Unless otherwise agreed in writing (i.e. customer specific specification), changes to the content of this datasheet may occur without notice, provided that the changes do not have a significant effect on the usability of the optoelectronic components

|  |   |                        |                                 |                                      |  |
|--|---|------------------------|---------------------------------|--------------------------------------|--|
|  | CHECKED<br>ZAn  | REVISION<br>003.000    | DATE (YYYY-MM-DD)<br>2021-07-01 | GENERAL TOLERANCE<br>DIN ISO 2768-1m | PROJECTION METHOD<br> |
|  | DESCRIPTION<br><b>WL-SWTP SMT White Top view<br/>PLCC</b>   |                        |                                 |                                      | ORDER CODE<br><b>158563450</b>   |
|  | Würth Elektronik eiSos GmbH & Co. KG<br>EMC & Inductive Solutions<br>Max-Eyth-Str. 1<br>74638 Waldenburg<br>Germany<br>Tel. +49 (0) 79 42 945 - 0<br>www.we-online.com<br>eiSos@we-online.com |                        |                                 |                                      |  |
|  | SIZE/TYPE<br>5630   | BUSINESS UNIT<br>eiPal | STATUS<br>Valid                 | PAGE<br>9/10                         |  |

## Important Notes

The following conditions apply to all goods within the product range of Würth Elektronik eiSos GmbH & Co. KG:

### 1. General Customer Responsibility

Some goods within the product range of Würth Elektronik eiSos GmbH & Co. KG contain statements regarding general suitability for certain application areas. These statements about suitability are based on our knowledge and experience of typical requirements concerning the areas, serve as general guidance and cannot be estimated as binding statements about the suitability for a customer application. The responsibility for the applicability and use in a particular customer design is always solely within the authority of the customer. Due to this fact it is up to the customer to evaluate, where appropriate to investigate and decide whether the device with the specific product characteristics described in the product specification is valid and suitable for the respective customer application or not.

### 2. Customer Responsibility related to Specific, in particular Safety-Relevant Applications

It has to be clearly pointed out that the possibility of a malfunction of electronic components or failure before the end of the usual lifetime cannot be completely eliminated in the current state of the art, even if the products are operated within the range of the specifications. In certain customer applications requiring a very high level of safety and especially in customer applications in which the malfunction or failure of an electronic component could endanger human life or health it must be ensured by most advanced technological aid of suitable design of the customer application that no injury or damage is caused to third parties in the event of malfunction or failure of an electronic component. Therefore, customer is cautioned to verify that data sheets are current before placing orders. The current data sheets can be downloaded at [www.we-online.com](http://www.we-online.com).

### 3. Best Care and Attention

Any product-specific notes, cautions and warnings must be strictly observed. Any disregard will result in the loss of warranty.

### 4. Customer Support for Product Specifications

Some products within the product range may contain substances which are subject to restrictions in certain jurisdictions in order to serve specific technical requirements. Necessary information is available on request. In this case the field sales engineer or the internal sales person in charge should be contacted who will be happy to support in this matter.

### 5. Product R&D

Due to constant product improvement product specifications may change from time to time. As a standard reporting procedure of the Product Change Notification (PCN) according to the JEDEC-Standard inform about minor and major changes. In case of further queries regarding the PCN, the field sales engineer or the internal sales person in charge should be contacted. The basic responsibility of the customer as per Section 1 and 2 remains unaffected.

## 6. Product Life Cycle



Due to technical progress and economical evaluation we also reserve the right to discontinue production and delivery of products. As a standard reporting procedure of the Product Termination Notification (PTN) according to the JEDEC-Standard we will inform at an early stage about inevitable product discontinuance. According to this we cannot guarantee that all products within our product range will always be available. Therefore it needs to be verified with the field sales engineer or the internal sales person in charge about the current product availability expectancy before or when the product for application design-in disposal is considered. The approach named above does not apply in the case of individual agreements deviating from the foregoing for customer-specific products.

## 7. Property Rights

All the rights for contractual products produced by Würth Elektronik eiSos GmbH & Co. KG on the basis of ideas, development contracts as well as models or templates that are subject to copyright, patent or commercial protection supplied to the customer will remain with Würth Elektronik eiSos GmbH & Co. KG. Würth Elektronik eiSos GmbH & Co. KG does not warrant or represent that any license, either expressed or implied, is granted under any patent right, copyright, mask work right, or other intellectual property right relating to any combination, application, or process in which Würth Elektronik eiSos GmbH & Co. KG components or services are used.

## 8. General Terms and Conditions

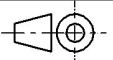
Unless otherwise agreed in individual contracts, all orders are subject to the current version of the "General Terms and Conditions of Würth Elektronik eiSos Group", last version available at [www.we-online.com](http://www.we-online.com).

|  |   |          |                   |                   |                   |   |
|--|---|----------|-------------------|-------------------|-------------------|---|
|  | CHECKED   | REVISION | DATE (YYYY-MM-DD) | GENERAL TOLERANCE | PROJECTION METHOD |  |
|  | ZAn   | 003.000  | 2021-07-01        | DIN ISO 2768-1m   |                   |   |
|  | <b>DESCRIPTION</b><br><b>WL-SWTP SMT White Top view</b><br><b>PLCC</b>  |          |                   |                   | ORDER CODE        |   |
|  | Würth Elektronik eiSos GmbH & Co. KG<br>EMC & Inductive Solutions<br>Max-Eyth-Str. 1<br>74638 Waldenburg<br>Germany<br>Tel. +49 (0) 79 42 945 - 0<br><a href="http://www.we-online.com">www.we-online.com</a><br><a href="mailto:eiSos@we-online.com">eiSos@we-online.com</a> |          |                   |                   | <b>158563450</b>  |   |
| SIZE/TYPE  | BUSINESS UNIT   | STATUS   | PAGE              |                   |                   |   |
| 5630   | eiPal   | Valid    | 10/10             |                   |                   |   |