

Heavy Duty Manifold Pressure Gauge Model HD780

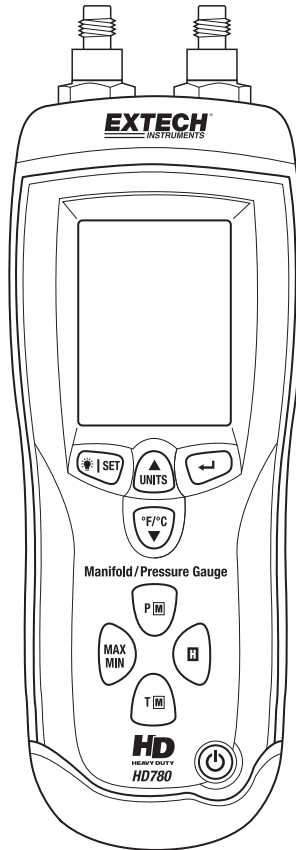



Introduction

Congratulations on your purchase of the Extech Instruments Heavy Duty Manifold and Pressure Gauge Model HD780. This device is a portable, digital refrigerant manifold meter that measures high pressure, Type K temperature and ambient temperature. This meter is shipped fully tested and calibrated and, with proper use, will provide years of reliable service. Please visit our website (www.extech.com) to check for the latest version of this User Manual, Translations, Product Updates, Customer Support, and Product Registration.

Features

- Measures psi, kPA, inHg, cmHg, bar, plus Type K and ambient temperature
- Automatic Temperature Compensation
- Auto power off feature saves battery life
- Easy-to-read LCD with backlight
- Data hold and MIN-MAX readings
- Includes two heavy duty pressure hoses, protective rubber holster, two Type K temperature clamp probes, two general purpose Type K bead wire temperature probes, Universal AC adaptor with plugs (US, EU, UK, AUS), 9V battery, and hard case.

Meter Description

1. Probe Connection
2. LCD Display
3.  / SET Button
4.  / UNITS Button
5. ENTER Button
6. °F / °C /  Button
7. P (P1, P2 selection) M (mode) Button
8. MAX / MIN Button
9. H (Hold) Button
10. T (T1, T2 selection) / M (mode) Button
11. POWER Button

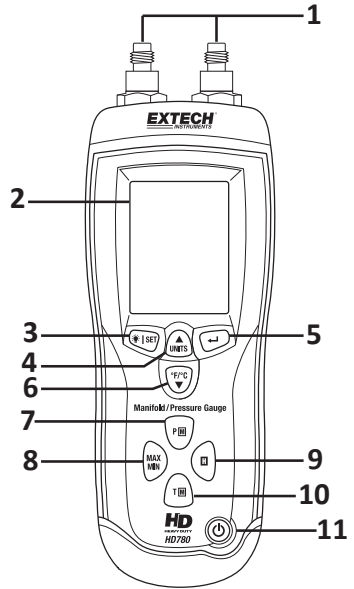

RIGHT SIDE VIEW

1. T2 Input
2. DC 9V Power Adapter Input Socket

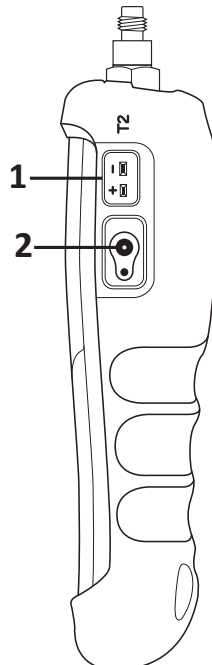

LEFT SIDE VIEW

1. T1 Input
2. Ambient Temperature sensor
3. Battery compartment (Back)

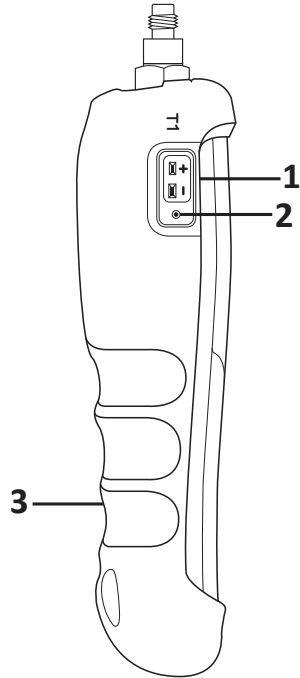





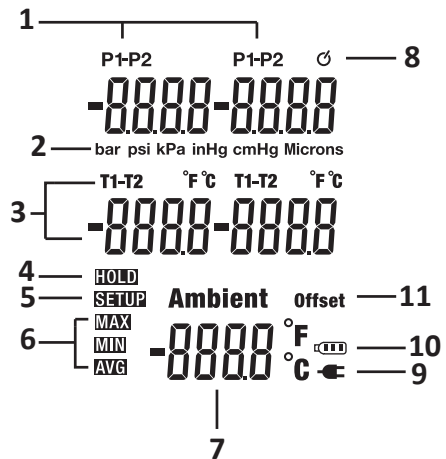

DISPLAY

1. P1, P2 and P1-P2 Pressure
2. Pressure units
3. T1, T2, T1-T2 Temperature
4. Hold icon
5. Setup icon
6. MAX/MIN/AVG indicators
7. Ambient Temperature
8. Auto power off symbol
9. Power adapter indicator
10. Low Battery Indicator
11. Offset





Operation

Button Descriptions

	Power ON/OFF the meter
MAX/MIN	Select MAX/MIN/AVG
P 	Toggle between P1 and P2
H 	Freeze the readings on the display
T 	Toggle between T1 and T2 (The middle display shows the temperature plus the offset. See the SETUP section to adjust the offset values for T1 and T2)
 /SET	Press once to power ON/OFF backlight or press for 3 seconds to enter/exit setup mode
▲/UNITS	Change the pressure units, scroll through setup options, or increase the displayed setting
°F/°C ▼	Change the temperature units, scroll through setup options, or decrease the displayed setting
	Press one time to enter setup option. Press two times to store the displayed setting into memory

Display Backlight

To turn the display backlight ON, momentarily press the backlight  button. To turn the backlight off press the backlight  button one more time.

Data Hold

To freeze a displayed reading on the LCD, press the HOLD button one time (the HOLD icon will appear on the bottom left portion of the LCD). To exit HOLD, press the HOLD button again.

Units of Measure

The currently selected unit of measure is shown below the measurement value on the top sections of the meter's LCD. To change the unit of measure, press the **▲/UNITS** button until the desired unit of measure appears.

Displaying Pressure

Press Unit button to scroll through available pressure units of measure. Press **P**  button to toggle between P1, P2, P1-P2 readings.

Displaying Temperature

Press unit button to select C/F. Press **T**  button to toggle between T1, T2, T1-T2 readings. The display shows dashes (- - -) when there is no thermocouple connected. The display shows "OL" when the temperature being measured is outside the thermocouple range.

Viewing MAX-MIN-AVG

For a given measurement session, this meter can record the highest (MAX) and the lowest (MIN) readings for later recall.





1. Press the MAX-MIN button to view the current MAX readings (MAX icon appears). The readings on the display are now the highest readings logged.
2. Press the MAX-MIN button again to view the current MIN readings (MIN icon appears). The readings on the display are now the lowest readings logged.
3. Press MAX-MIN button once more to view the current AVG readings (AVG icon appears). The readings on the display are now the lowest readings logged.

To exit the MAX-MIN mode, press and hold the MAX-MIN button for 3 seconds. The MAX-MIN-AVG icons will switch off and the meter will return to the normal operating mode.

Zero Adjust (Pressure)

The unit must be kept in the upright position when ZEROING or when taking measurements. To ZERO the meter: Before use and without fittings attached to the meter, press and hold the  button for 3 seconds or until the display shows all zeroes.

Setup Mode

Press and hold the /SET button for three seconds to enter the Setup Mode. Momentarily pressing the  or  buttons will cycle throughout the functions. Press  to select the desired function. Setup is disabled in MIN/MAX mode. They are (in order):



OFFSET.....Store offsets for T1 and T2

SLP.....Sleep mode





Note: Press and hold the **SET** button for three seconds when in the Set Mode to exit.

Offset

Use the offset option to compensate for a specific thermocouple temperature error or mismatch. The allowable adjustment range is $\pm 5.0^{\circ}\text{C}$ (9.0°F).

1. Plug the thermocouple into the T1 or T2 input connector located on either side of the meter.
2. Place the thermocouple in a known, stable environment.
3. Allow the readings to stabilize. The primary display shows the temperature, while the bottom display shows the offset value.
4. Use the  and  buttons to adjust the offset until the primary reading matches the calibration temperature. Press  button to store the value and move to the next setup mode option.

Sleep Mode (Auto Power OFF)

With sleep mode active, the meter automatically powers off after 20 minutes of inactivity. To defeat this feature, while in SLP mode, press  to indicate ON (sleep mode ON) or OFF (sleep mode OFF). Press  or  buttons to make a selection. Press  to store the new setting in memory.

Battery Replacement



WARNING: To avoid electrical shock, remove the test leads, disconnect the meter from any circuit and turn OFF the meter before opening the case. Do not operate with an open case.

Battery Replacement

When the low battery icon  appears on the LCD, the batteries must be replaced. Several hours of accurate readings are still possible in this condition; however, batteries should be replaced as soon as possible:

- Remove the cover from the rear of the meter.
- Replace the one (1) 9V battery observing polarity.
- Replace the battery compartment cover.

Note: The meter can also be powered by a DC 9V Power Adapter. The meter will be permanently powered ON when the DC adapter is used as the power supply (the power button function is disabled).

Safety: Please dispose of batteries responsibly; never dispose of batteries in a fire, batteries may explode or leak. If the meter is not to be used for 60 days or more, remove the battery and store separately.



Never dispose of used batteries or rechargeable batteries in household waste.

As consumers, users are legally required to take used batteries to appropriate collection sites, the retail store where the batteries were purchased, or wherever batteries are sold.

Disposal: Do not dispose of this instrument in household waste. The user is obligated to take end-of-life devices to a designated collection point for the disposal of electrical and electronic equipment.

Specifications

Function	Range	Resolution	Accuracy
Pressure	-14 to 0 psi	0.1	±(0.3 psi)
	0 to 200 psi	0.1	±(1.0 psi)
	200 to 400 psi	0.1	±(0.3% + 1 psi)
	400 to 500 psi	0.1	±(0.3% + 1.5psi)
	-96 to 0 kPa	1	±(2 kPa)
	-0 to 1378 kPa	1	±(7 kPa)
	1378 to 2757 kPa	1	±(0.3% + 7 kPa)
	2757 to 3447 kPa	1	±(0.3% + 10 kPa)
	-0.96 to 0 bar	0.01	±(0.02 bar)
	0 to 13.79 bar	0.01	±(0.1 bar)
	13.79 to 34.47 bar	0.01	±(0.3% + 0.1 bar)
	-28 to 0 inHg	0.1	±(0.4 inHg)
	0 to 407 inHg	0.1	±(2 inHg)
	407 to 814 inHg	0.1	±(0.3% + 2 inHg)
	814 to 999.9	0.1	±(0.3% + 3 inHg)
	-72 to 0 cmHg	1	±(1 cmHg)
	0 to 1034 cmHg	1	±(5 cmHg)
1034 to 2068 cmHg	1	±(0.3% + 6 cmHg)	
2068 to 2585 cmHg	1	±(0.3% + 8 cmHg)	
Type K thermocouple (T1/T2 Temperature)	-60°C to 537.0°C (-76°F to 999.9°F)	0.1	±(0.15%rdg + 1.0°C) ±(0.15%rdg + 1.8°F)
Ambient Temperature (Sensor Type: NTC)	0°C to 50.0°C (32.0°F to 122.0°F)	0.1	±1.0°C (±2.0°F)

General Specifications

Pressure Connector Type	Standard ¼ NPT male flare fitting
Stated Accuracy	@ 25°C (77 °F) <75%RH
Max. Overload Pressure	800psi
Data Hold	Freezes displayed reading
Auto Power OFF	After approx. 30 minutes of inactivity (can be deactivated)
Storage conditions	-20 to 60°C (-4 to 140°F); < 80% RH (with battery removed)
Operating conditions	0 to 50°C (32 to 122°F); < 75% RH
Battery power	9V battery (Low battery indicator)
Dimensions	23.5 x 7.6 x 5 cm (9.3 x 3.0 x 2.0")
Weight	460g (16.2 oz.)

Copyright © 2016 FLIR Systems, Inc.

All rights reserved including the right of reproduction in whole or in part in any form

ISO-9001 Certified

www.extech.com