

**PLEASE CHECK WWW.MOLEX.COM FOR LATEST PART INFORMATION**

**Part Number:** [53358-0440](#)  
**Status:** **Active**  
**Description:** 2.00mm Pitch Mi II™ Wire-to-Wire Adapter, 4 Circuits, Lead-Free

**Documents:**

3D Model [Product Specification PS-53358-001 \(PDF\)](#)  
Drawing (PDF) [RoHS Certificate of Compliance \(PDF\)](#)  
Product Specification PS-51090-003 (PDF)

**Agency Certification**

CSA LR19980  
UL E29179

**General**

Product Family Accessories  
Series [53358](#)  
Comments For Panel Mounting  
Component Type Adapter  
Product Name Mi II™  
UPC 756054584958

**Physical**

Circuits (Loaded) 4  
Color - Resin Natural  
Flammability 94V-0  
Gender N/A  
Lock to Mating Part Yes  
Material - Metal Brass  
Material - Plating Mating Tin  
Material - Plating Termination Tin  
Material - Resin Polyester  
Net Weight 926.500/mg  
Number of Rows 1  
Packaging Type Bag  
Plating min - Mating 1.016µm  
Plating min - Termination 1.016µm  
Polarized to Mating Part Yes  
Temperature Range - Operating -40°C to +105°C

**Electrical**

Current - Maximum per Contact 2A

**Material Info**

**Reference - Drawing Numbers**

Product Specification PS-51090-003, PS-53358-001, RPS-53358-001  
Sales Drawing SD-53358-001

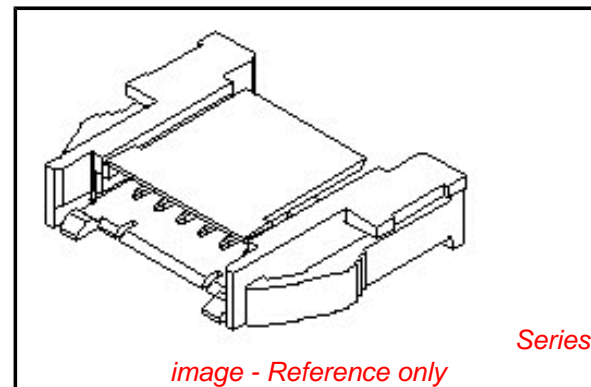

**EU RoHS**

**ELV and RoHS  
Compliant**  
**REACH SVHC  
Contains SVHC: No  
Low-Halogen Status  
Not Low-Halogen**

**China RoHS**



**Need more information on product  
environmental compliance?**

Email [productcompliance@molex.com](mailto:productcompliance@molex.com)  
For a multiple part number RoHS Certificate of  
Compliance, [click here](#)

Please visit the [Contact Us](#) section for any  
non-product compliance questions.

**Search Parts in this Series**

[53358Series](#)

**Use With**

[51090 Crimp Housing](#), [52484 IDT Housing](#)