



# IDS-342(+)

## Industrial 4 secure serial port to Ethernet device server with 4xRS-232/422/485 and 2x10/100Base-T(X)

### Features

- Operating Modes: Virtual Com, Serial Tunnel, TCP Server, TCP Client, UDP
- Support Modbus Gateway: Modbus TCP, Modbus RTU and Modbus ASCII
- Support 4xRS-232/422/485 in DB9 connector
- Redundant multiple host devices:  
5 host devices: Virtual COM, TCP Server, TCP Client mode;  
4 IP ranges: UDP
- Security: SSL data encryption; secured management by HTTPS and SSH: IP Access: IP White List
- Event Warning by Syslog, Email, SNMP trap, Relay and Beeper
- Configurable by Web-based and Windows utility (**DS-Tool**)
- Various Windows O.S. supported:  
Windows NT/2000/ XP/ 2003/VISTA(32/64bit)/ Windows 7(32/64bit)
- Ethernet switch mode enable Daisy Chain
- 1KV isolation for PoE PD port (802.3af)
- Support OpenWRT SDK for project



### Introduction

IDS-342 is an innovative secure 4 port RS-232/422/485 to 2 ports LAN secure device server with standard features of device server, such like TCP/IP interface and versatile operation modes: Virtual Com, Serial Tunnel, TCP Server, TCP Client, and UDP. In addition, the Windows utility, DS-Tool, could configure multiple devices and set up the mappings of Virtual Com. On the other hand, IDS-342 can simultaneously transfer data up to 5 redundant host PCs to avoid Ethernet connection breakdown or any host PC fails. Further, IDS-342 features HTTPS, SSH, and SSL encryption to assure the security of critical data transmission.

IDS-342 supports RS-232/422/485 and provides dual redundant power inputs, 12~48 VDC, on terminal block to guarantee a non-stop operation. Further, IDS-342 features PoE PD (Power Device) function, compliant with IEEE802.3af standard, with 1kv isolation on the PoE port. With wide operating temperature, -40~70°C, and rugged IP-30 housing design, IDS-342 series could operate in the harsh industrial environment. Therefore, IDS-342 is the best solution to the high demand of secure serial to Ethernet critical data communication.

### Practical Operation

In practical operation of serial device servers, Windows utility (DS-Tool) is supported. This utility is very helpful for you to manage and monitor all of industrial device servers on the industrial network.

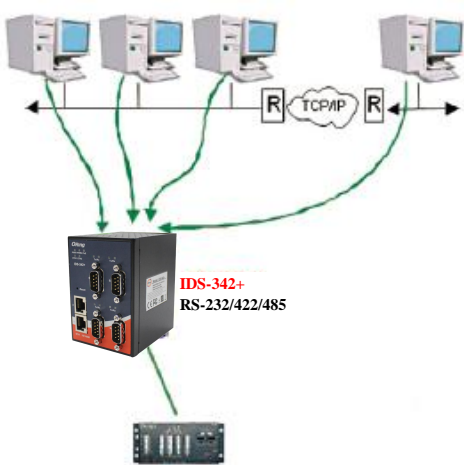

Multiple Host PCs

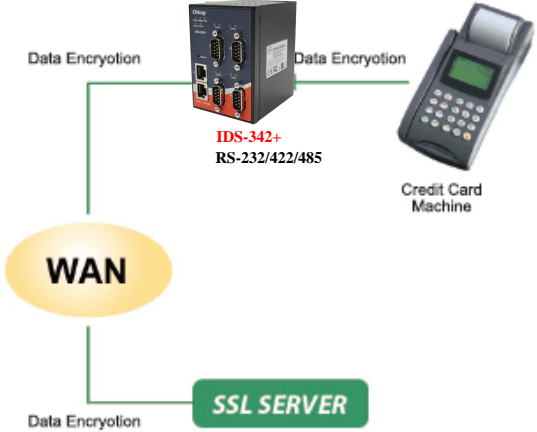

SSL Data Encryotion

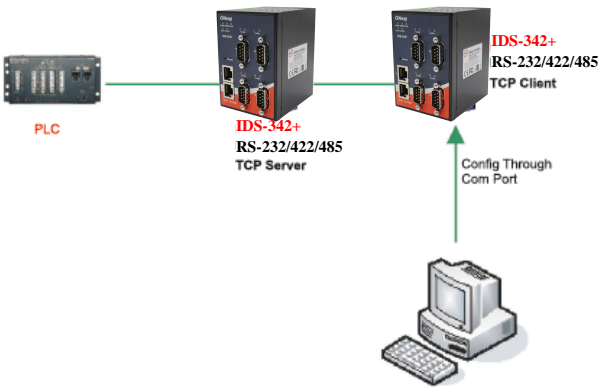

TCP Client/Server Modes

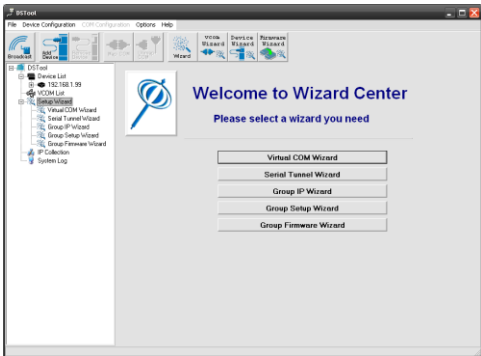
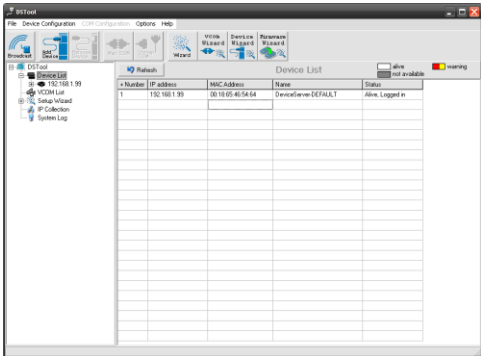

DS-Tool (Windows Utility): Monitoring and Configuration

## Pin Definition

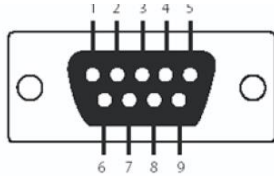

DB9 connector

Pin #	RS-232	RS-422	RS-485 ( 4 wire )	RS-485 ( 2 wire )
1	DCD	TX-	TX-	DATA -
2	RXD	TX+	TX+	DATA +
3	TXD	RX+	RX+	
4	DTR	RX-	RX-	
5	GND	GND	GND	
6	DSR			
7	RTS			
8	CTS			
9	RI			

## Dimension

Dimension (Unit =mm)

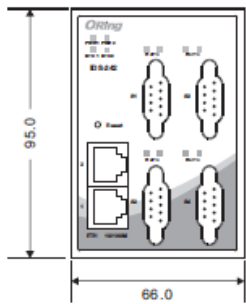
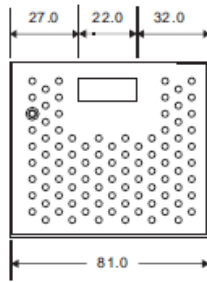

IDS-342

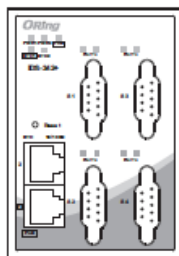

IDS-342+

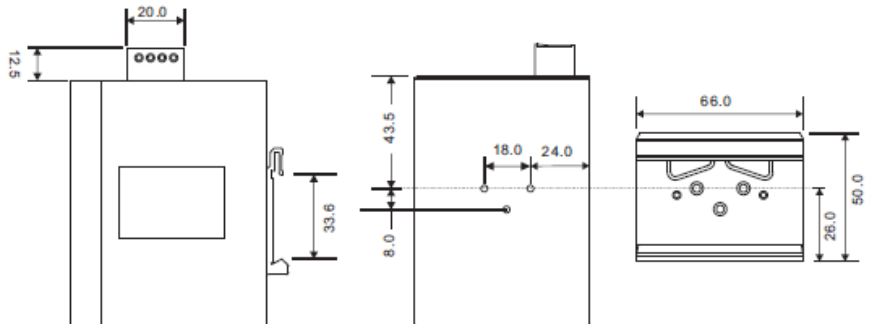

## Specifications

ORing Device Server Model	IDS-342	IDS-342+
<b>Physical Ports</b>		
10/100 Base-T(X) Ports in RJ45 Auto MDI/MDIX	2	
P.O.E.		P.O.E.Present at ETH1 Power Device (IEEE 802.3af): IEEE 802.3af compliant input interface Over load & short circuit protection Isolation Voltage: 1000 VDC min. Isolation Resistance : 10 <sup>8</sup> ohms min
<b>Serial Ports</b>		
Connector	DB9 x 4	
Operation Mode	RS-232/422/485	
Serial Baud Rate	110 bps to 460.8 Kbps	
Data Bits	7, 8	
Parity	odd, even, none, mark, space	
Stop Bits	1, 1.5, 2	
RS-232	TxD, RxD, RTS, CTS, DTR, DSR, DCD, RI, GND	
Flow Control	XON/XOFF, RTS/CTS, DTR/DSR	
<b>Network Protocol</b>		
Protocol	ICMP, IP, TCP, UDP, DHCP, BOOTP, SSH, DNS, SNMP V1/V2c, HTTPS, SMTP	
<b>LED indicators</b>		
Power indicator	3 x LEDs, PWR 1(2)(PoE) / Ready: Green On: Power is on	
10/100TX RJ45 port indicator	Green for port Link/Act at 100Mbps.	
Serial TX / RX LEDs:	Amber: Serial port is receiving data Green: Serial port is transmitting data	
<b>Power</b>		
Redundant Input power	Dual DC inputs. 12-48VDC on 6-pin terminal block	Dual DC inputs. 12-48VDC on 6-pin terminal block IEEE 802.3af PoE PD (Eth 1)
Power consumption (Typ.)	4.32W	
Overload current protection	Present	
Reverse polarity protection	Present on terminal block	
<b>Physical Characteristic</b>		
Enclosure	IP-30	
Dimension (W x D x H)	66 (W) x 81 (D) x 95 (H) mm	
Weight (g)	375g	384g
<b>Environmental</b>		
Storage Temperature	-40 to 85°C (-40 to 185°F)	
Operating Temperature	-40 to 70°C (-40 to 158°F)	
Operating Humidity	5% to 95% Non-condensing	
<b>Regulatory approvals</b>		
EMI	FCC Part 15, CISPR (EN55022) class A	
EMS	EN61000-4-2 (ESD), EN61000-4-3 (RS), EN61000-4-4 (EFT), EN61000-4-5 (Surge), EN61000-4-6 (CS), EN61000-4-8, EN61000-4-11	
Shock	IEC60068-2-27	
Free Fall	IEC60068-2-32	
Vibration	IEC60068-2-6	

Safety	EN60950-1
Warranty	5 years

## Ordering Information

**IDS-3ABC**

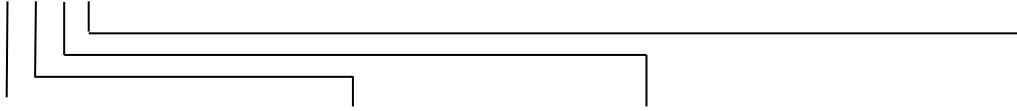

Code Definition	Serial Port Type	Serial Port Number	Ethernet port Number	POE Identification
Option	- 1: RS-232 - 2: RS-422/485 - 3: RS-232/422/485	- 4: 4 ports	- 2: 2 ports	- "+": P.O.E. PD present at ETH1

Available Model	Model Name	Description
	IDS-342	Industrial 4-port secure serial to Ethernet device server with 4xRS-232/422/485 and 2x10/100Base-T(X)
	IDS-342+	Industrial 4-port secure serial to Ethernet device server with 4xRS-232/422/485 and 2x10/100Base-T(X), 1-port PoE P.D.

## Packing List

- IDS-342(+) x 1
- Din-Rail Kit x 1
- CD x 1
- Quick Installation Guide x 1

## Optional Accessories

- DR-45 series : 45 Watts power supply
- DR-120 series : 120 Watts power supply
- DR-75 series : 75 Watts power supply