



CM4 NANO

AN INDUSTRIAL EMBEDDED COMPUTER BASED ON RASPBERRY PI CM4

Shanghai EDA Technology Co.,Ltd
2023-01-09

Copyright Statement

ED-CM4Nano and its related intellectual property rights are owned by Shanghai EDA Technology Co., Ltd. Shanghai EDA Technology Co., Ltd owns the copyright of this document and reserves all rights. Without the written permission of Shanghai EDA Technology Co., Ltd, no part of this document may be modified, distributed or copied in any way or form.

Disclaimers

Shanghai EDA Technology Co., Ltd does not guarantee that the information in this manual is up to date, correct, complete or of high quality. Shanghai EDA Technology Co., Ltd also does not guarantee the further use of this information. If the material or non-material related losses are caused by using or not using the information in this manual, or by using incorrect or incomplete information, as long as it is not proved that it is the intention or negligence of Shanghai EDA Technology Co., Ltd, the liability claim for Shanghai EDA Technology Co., Ltd can be exempted. Shanghai EDA Technology Co., Ltd expressly reserves the right to modify or supplement the contents or part of this manual without special notice.

Contents

1	Product Overview	5
1.1	Target Application	5
1.2	Specifications and Parameters	5
1.3	System Diagram	6
1.4	Functional Layout	6
1.5	Packing List	7
1.6	Order code	7
2	Product Appearance and Structure	8
2.1	Product Appearance	8
2.2	Product Photo	8
2.3	Dimensions	10
2.4	Mount Dimensional Drawings	11
2.4.1	DIN Mount	11
2.4.2	Wall Mount	12
3	Interfaces and Connectors	13
3.1	Front Panel	13
3.1.1	Power Input	13
3.1.2	Gigabit Ethernet	13
3.2	Rear Panel	14
3.2.1	Indicator Light	14
3.2.2	Micro SD Card	14
3.2.3	HDMI	14
3.2.4	USB 2.0	14
3.2.5	USB 3.0	15
3.3	Top Panel	15
3.3.1	BOOT	16
3.3.2	40PIN	16
3.4	Mini CSI	16
3.5	HDMI DSI	16
3.6	Antenna	17
3.6.1	WIFI/BT	17
4	Internal Interface	17
4.1	Power Output	17
4.2	USB 3.0 Type-C	17
4.3	RTC	18
4.4	Buzzer	18
4.5	HDMI FPC	18
5	Wireless Communication	19
5.1	WiFi	19
5.2	Bluetooth	19
5.3	Antenna	19
5.3.1	WiFi / BT Antenna	20

6	Electrical Characteristics	20
6.1	Electrical Parameters	20
7	FAQ.....	20
8	Product change record.....	21
9	About us	21
9.1	About EDATEC.....	21
9.2	Contact us	21

1 Product Overview

CM4 Nano is a computer based on Raspberry Pi CM4 for industrial application scenarios. CM4 Nano is compatible with Raspberry Pi software and hardware, and has the same overall size, which has made many enhancements to industrial applications.

1.1 Target Application

- Multimedia entertainment
- AI development
- Intelligent instrument
- Panoramic display
- Intelligent life

1.2 Specifications and Parameters

Function	Parameters
CPU	BCM2711 4 core Cortex A72 1.5GHz (ARM v8) 64-bit CPU
RAM	1GB/2GB/4GB/8GB
eMMC	8GB/16GB/32GB
WiFi/BT	2.4G/5.8G WiFi, Bluetooth BLE5.0
LAN port	10/100/1000M with POE
SD card	Support SD card as extended storage.
HDMI	1x HDMI A
HDMI FPC port	1 x HDMI + 1 USB touch
USB 3.0	3 standard USB 3.0 port
USB 2.0	1 standard USB 2.0 port
DSI	1 DSI port
CSI	1 CSI port
RTC	Support RTC function
Buzzer	1 buzzer
40PIN Connector	Raspberry Pi standard 40PIN interface
4 Pin PoE Connector	Support PoE
DC Output	5V@2A
LED indicator	green(system state), red(power)
Power Input	7V~18V DC
Dimensions	103mm(L) x 62mm(W) x 32mm(H)

Case	Aluminum alloy heat dissipation
antenna	PCB antenna/external antenna
Working temperature range	-25~60°C
OS	Compatible with official standard system

1.3 System Diagram

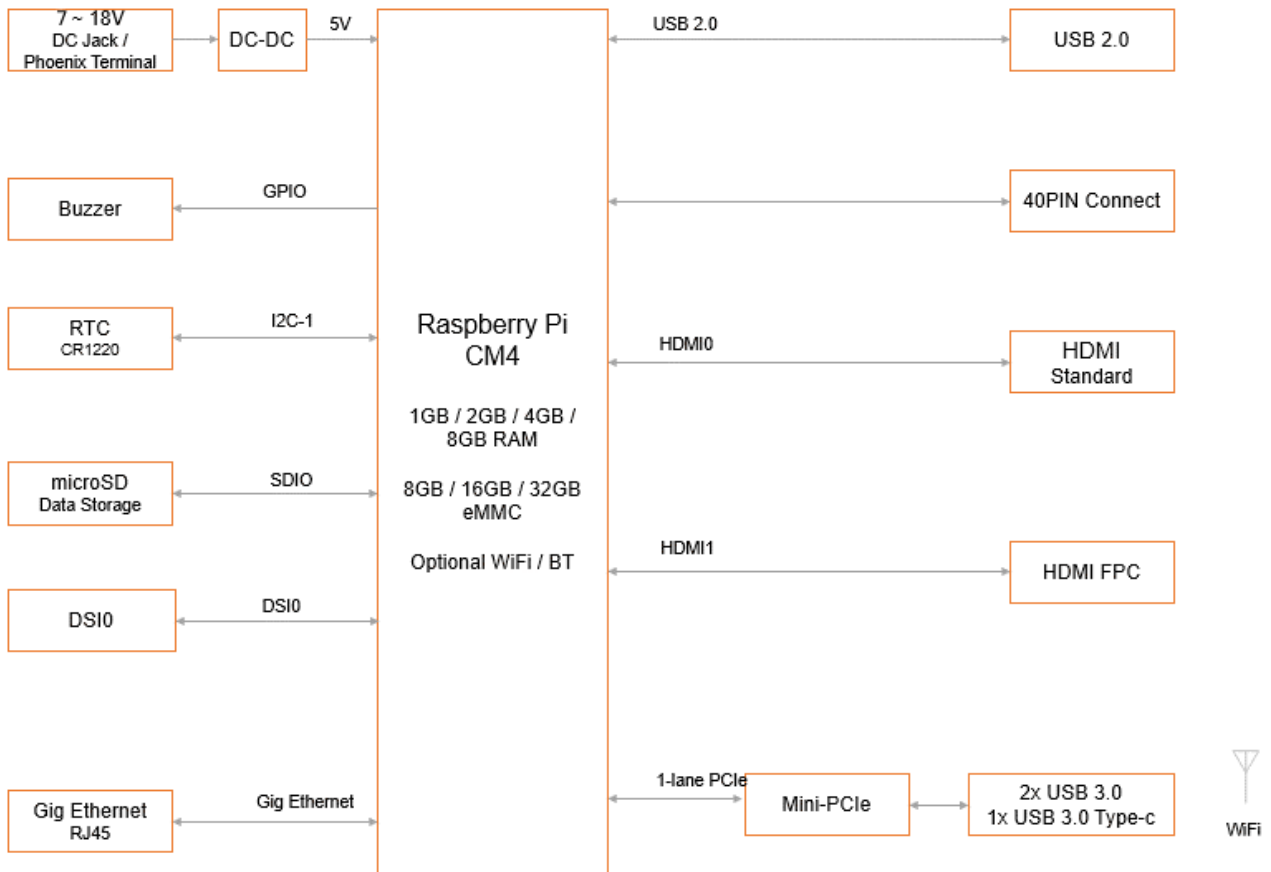

ED-CM4NANO: EDATEC CM4 NANO V1.0

1.4 Functional Layout

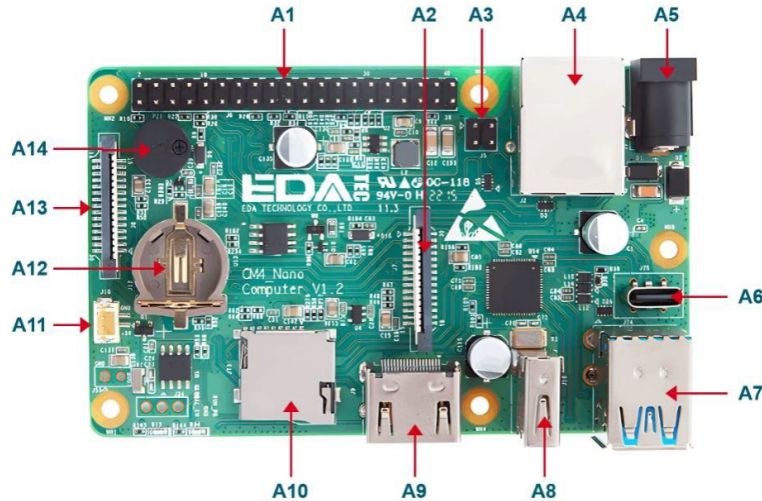

Item	Function Description	Item	Function Description
A1	40PIN	A2	CSI port
A3	PoE	A4	gigabit Ethernet
A5	DC power port	A6	Type-C USB 3.0 port
A7	USB 3.0	A8	USB 2.0
A9	Standard HDMI port	A10	SD card slot

1.5 Packing List

- 1x CM4 Nano
- 1x WIFI/BT antenna

1.6 Order code

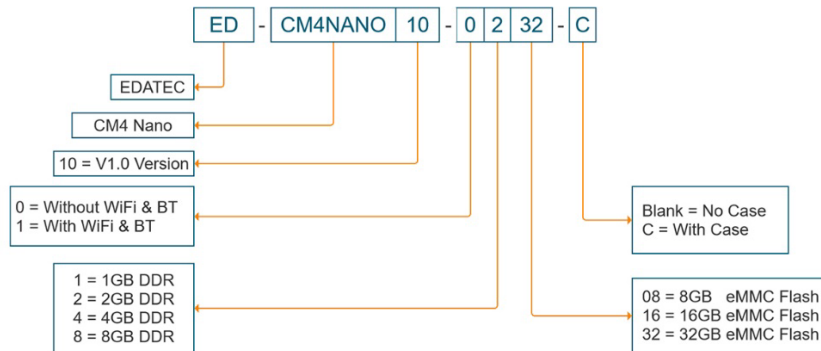

Example

Part#: ED-CM4NANO10-1208-C

Configuration: CM4 NANO Computer V1.0 version

1pcs Raspberry Pi certified WiFi/Bluetooth Antenna

2GB DDR & 8GB eMMC, WiFi & Bluetooth

Assembled by a metal case

2 Product Appearance and Structure

2.1 Product Appearance

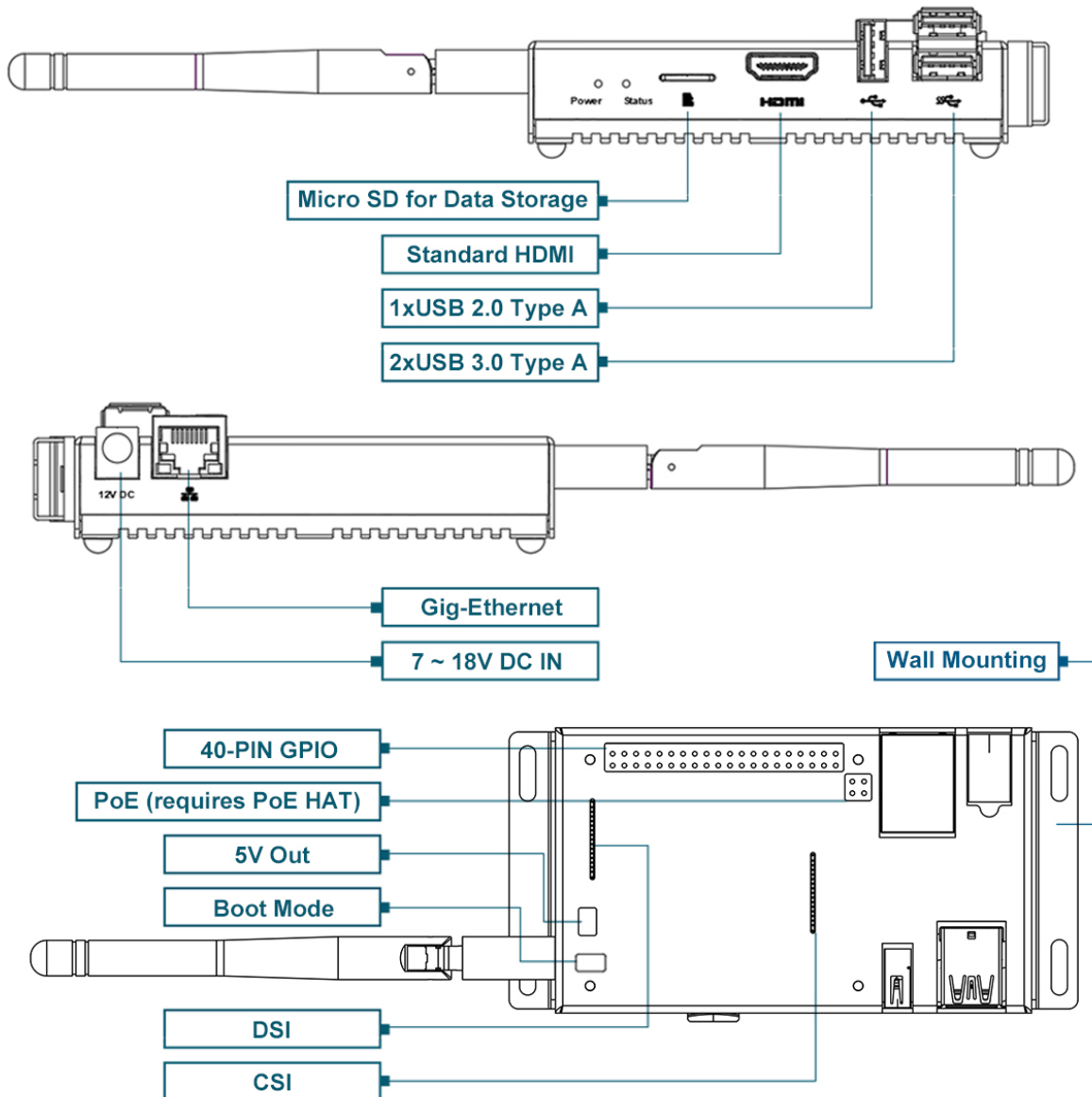

2.2 Product Photo



2.3 Dimensions

unit: mm, tolerance: $\pm 0.1\text{mm}$

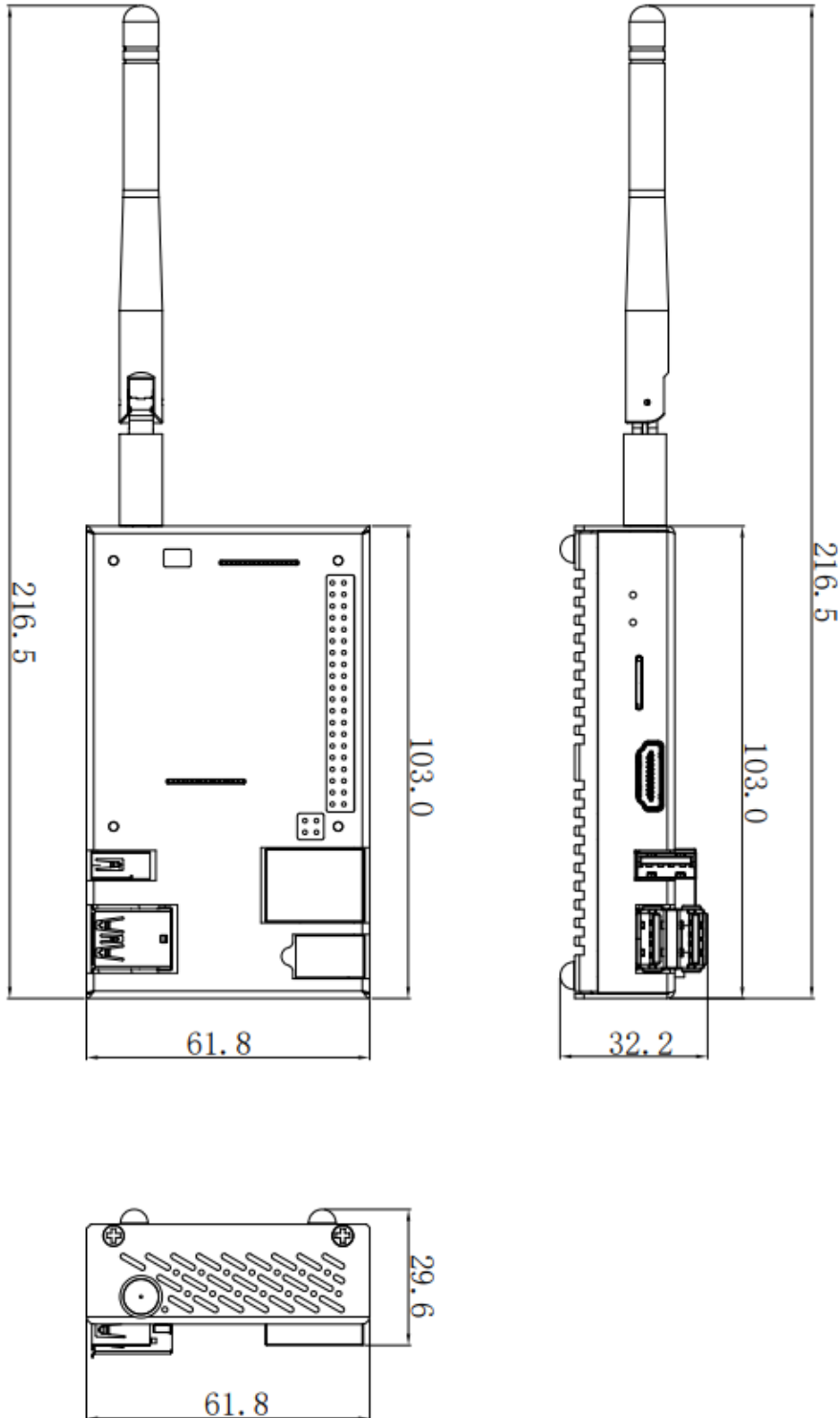

2.4 Mount Dimensional Drawings

2.4.1 DIN Mount

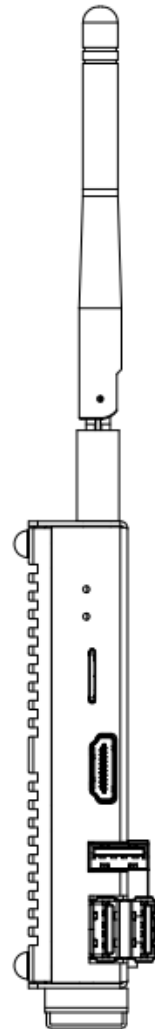
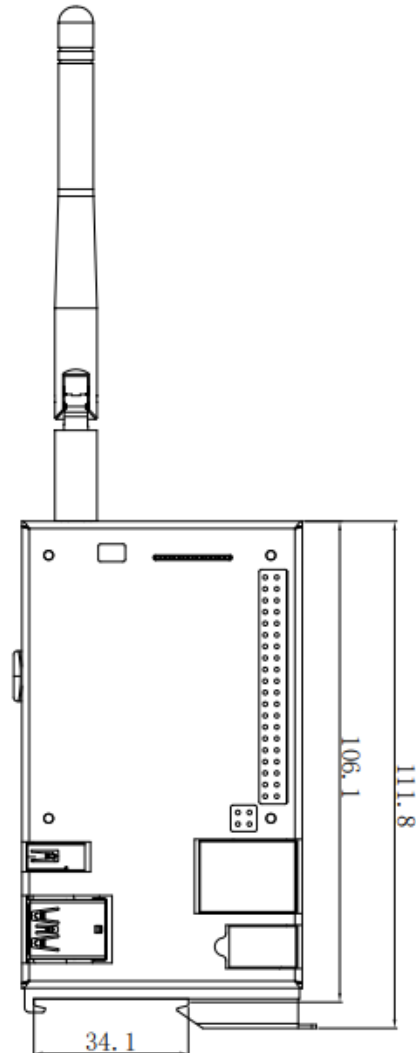
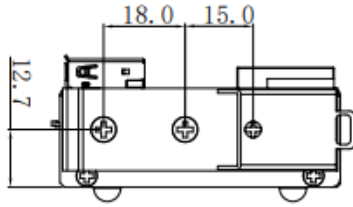

2.4.2 Wall Mount

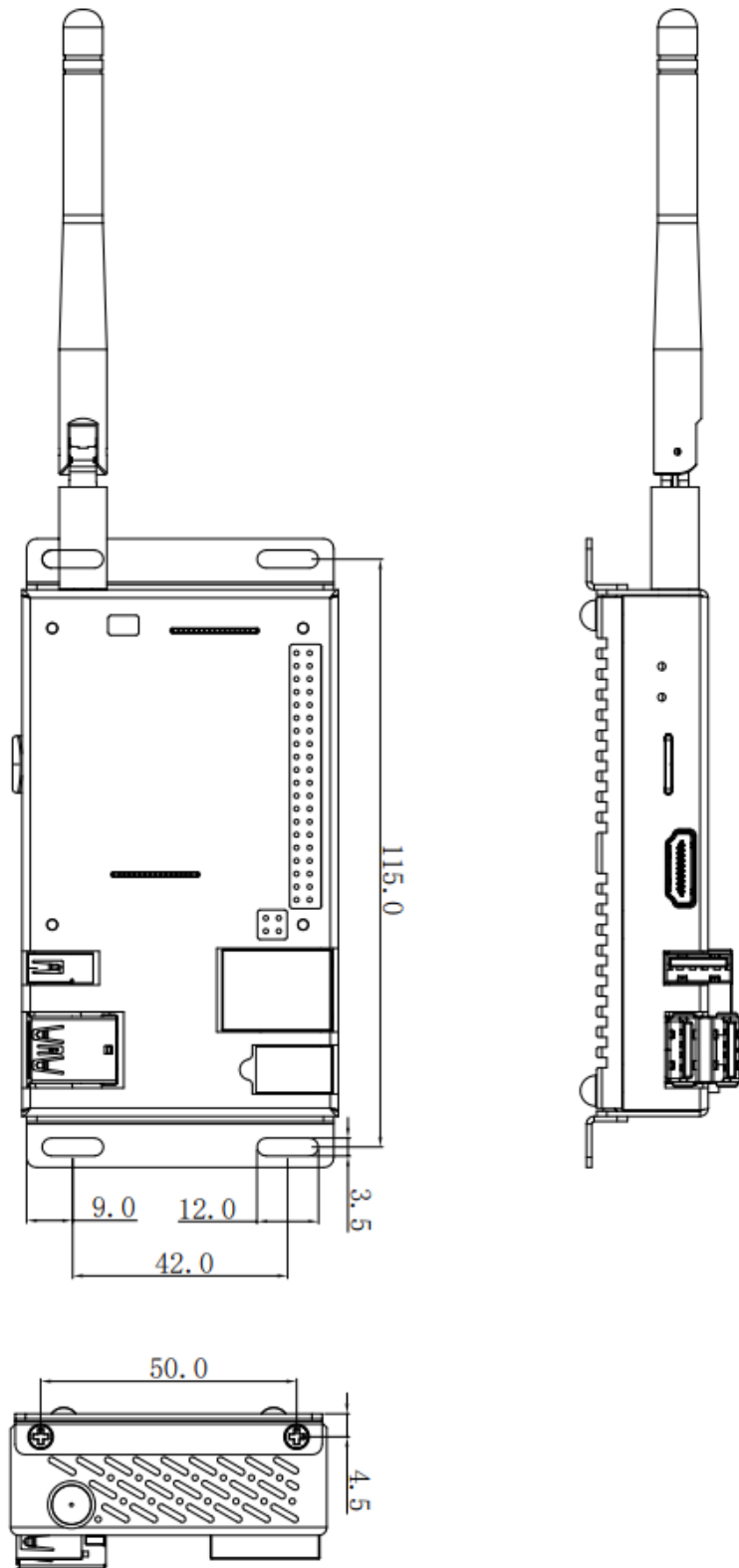

3 Interfaces and Connectors

3.1 Front Panel

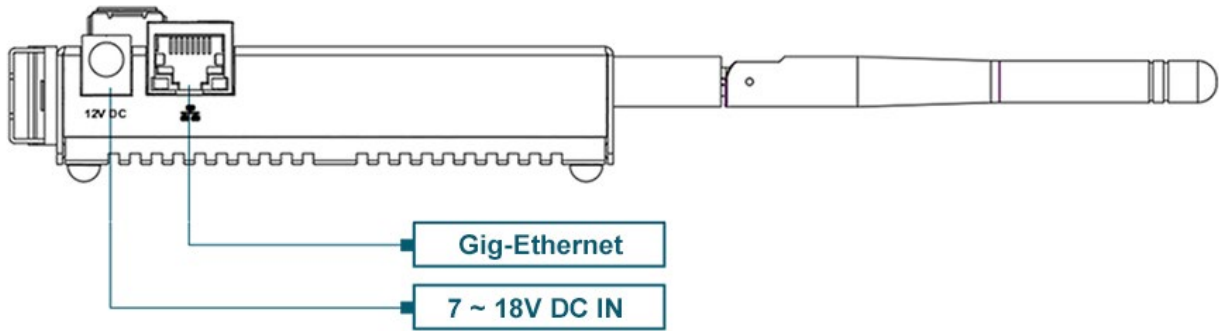

3.1.1 Power Input

The power interface is on the right panel, using DC Jack interface, supporting 7 ~ 18V DC power supply (V1.2 version), with positive inside and negative outside. Recommend customers to use a 12V power adapter.



3.1.2 Gigabit Ethernet

There is an adaptive 10/100/1000Mbps Ethernet on CM4 Nano, which uses RJ45 interface. It is recommended to use Cat6 (Category 6) network cable.

	Pin ID	Pin Name
	1	TRD0+
	2	TRD0-
	3	TRD1+
	4	TRD2+
	5	TRD2-
	6	TRD1-
	7	TRD3+
	8	TRD3-

3.2 Rear Panel

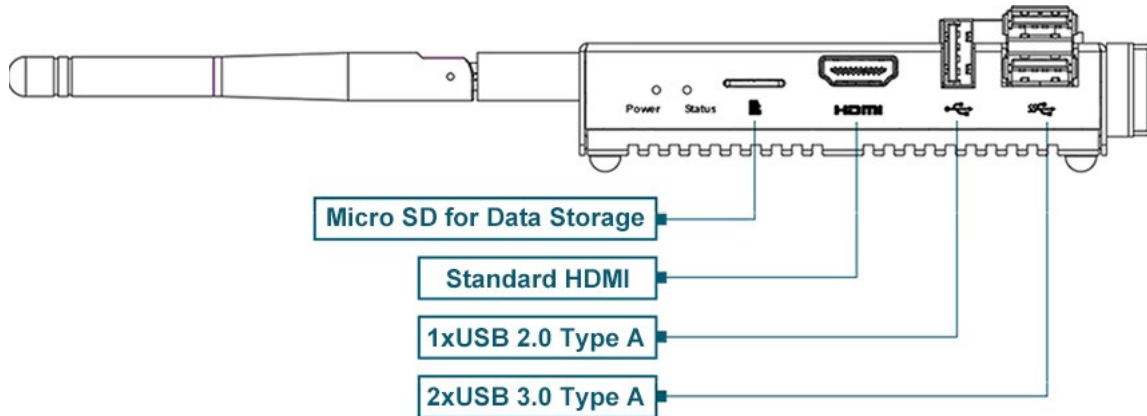

3.2.1 Indicator Light

CM4 Nano has 2 indicator lights:

Indicator	Describe
Red LED	Power indicator light
Green LED	Status indicator light

3.2.2 Micro SD Card

CM4 Nano supports dual storage scheme, eMMC+micro SD card. eMMC is used for main file system, and micro SD card can be used for extended data storage. Users can choose SD cards with different capacities to store data according to application requirements. Compared with the built-in eMMC memory, SD cards have larger capacity and lower cost. Users can use eMMC on CM4 to store system code and SD card to store application data.

NOTE: Micro SD card can only be used for extended storage and cannot be started from SD card.

3.2.3 HDMI

CM4 Nano has a standard HDMI Type A (full-size) interface, which uses CM4 HDMI0 signals and supports HDMI2.1 video output with a maximum resolution of 4Kp60.

3.2.4 USB 2.0

CM4 Nano has 1 USB 2.0 Type-A, which is used as a burning interface when burning the system. If BSP provided by our company has been installed in the system, this interface can be used as ordinary USB 2.0.

	Pin ID	Pin Name
	1	5V
	2	D-
	3	D+
4	GND	

3.2.5 USB 3.0

CM4 Nano has 2 USB 3.0 Type-A channels. Users can extend other peripherals at this interface.

	Pin ID	Pin Name
	1	5V
	2	D-
	3	D+
	4	GND
	5	StdA_SSRX-
	6	StdA_SSRX+
	7	GND_DRAIN
	8	StdA_SSTX-
9	StdA_SSTX+	

3.3 Top Panel

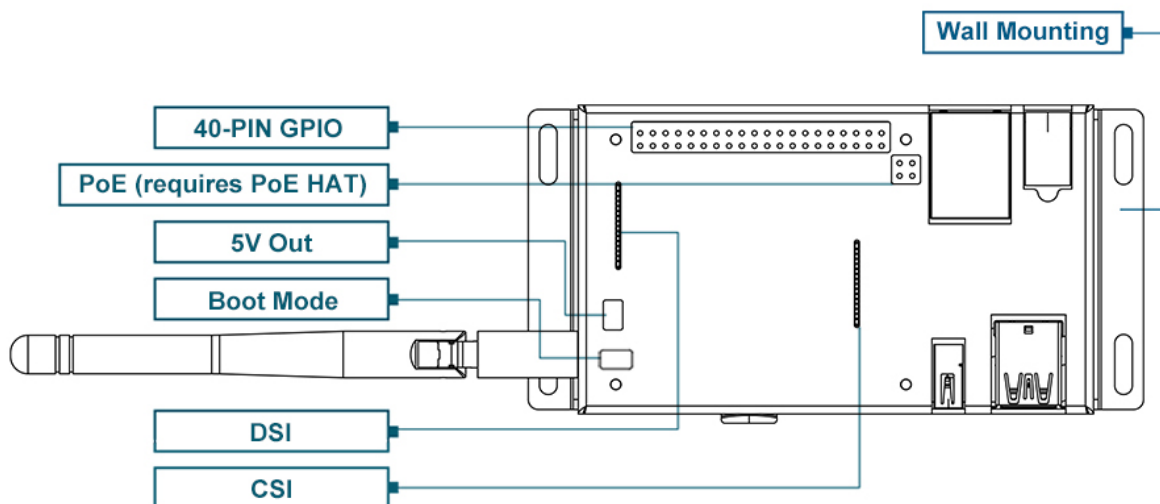

3.3.1 BOOT

The CM4 Nano Boot interface needs to be short-circuited with GND when burning, so that the eMMC can be burned only after the system enters the burning mode.

3.3.2 40PIN

CM4 Nano has a 40PIN compatible with raspberry pi, including two I2C, two S PI, a UART serial port and 28 GPIO pins.

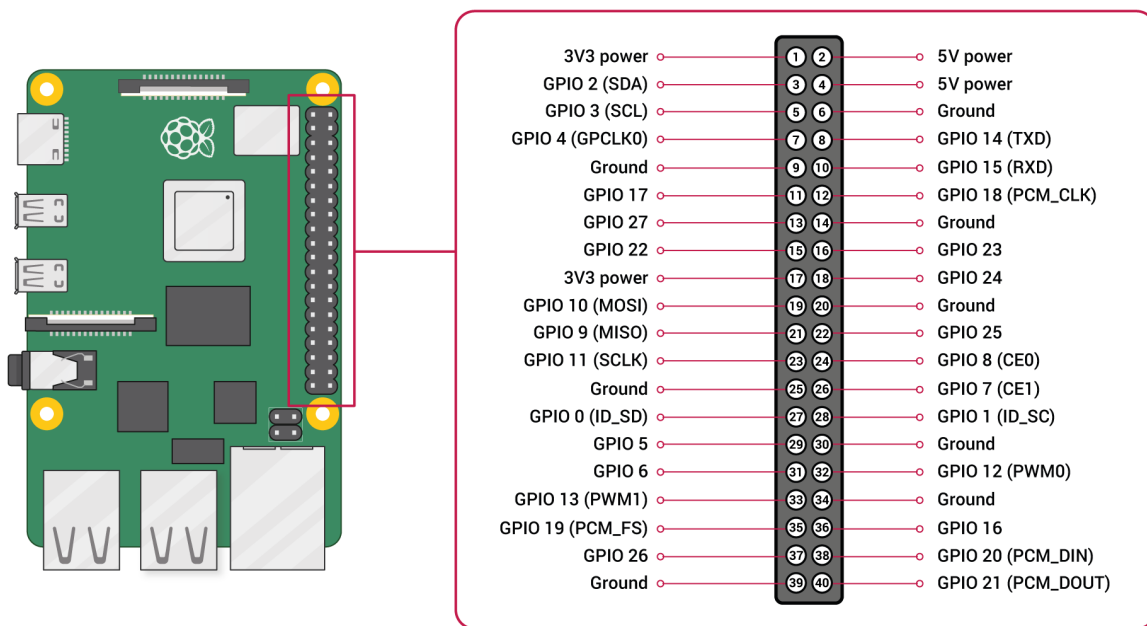

3.4 Mini CSI

J7 is a CSI interface, which is connected to the camera and supports various official models of Raspberry Pi cameras.

3.5 HDMI DSI

J8 is MIPI DSI interface, which uses DSI1 signals of 2-lane on CM4, and can be used with Raspberry Pi official 7-inch touch screen.

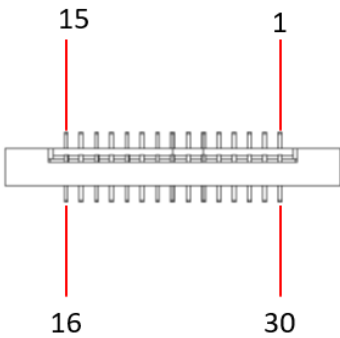

Pin	Definition	Pin	Definition
1	GND	9	DSI1_D0_P
2	DSI1_D1_N	10	GND
3	DSI1_D1_P	11	SCL0
4	GND	12	SDA0
5	DSI1_CLK_N	13	GND
6	DSI1_CLK_P	14	3V3
7	GND	15	3V3
8	DSI1_D0_N		

3.6 Antenna

3.6.1 WIFI/BT

CM4 Nano has a WIFI/BT antenna, which supports 2.4 GHz and 5.0 GHz IEEE 802.11b/g/n/AC dual-band WiFi. We provide dual-band external antenna, which has passed wireless authentication together with Raspberry Pi CM4.

4 Internal Interface

4.1 Power Output

CM4 Nano has a 2-pin Phoenix terminal interface J10, which supports the output of 5V@1A and can be used to drive loads.

4.2 USB 3.0 Type-C

In CM4 Nano, J75 is a USB 3.0 Type-C interface, which supports the connection of Type-C interface devices.

4.3 RTC

The CM4 Nano is integrated with RTC. For the version sold in China, we will install the CR1220 button cell (RTC backup power supply) by default when shipping. In this way, the system can be guaranteed to have an uninterrupted and reliable clock, which is not affected by factors such as equipment power down.

RTC clock chip is mounted on i2c-0 bus, and the device address is 0x51.

4.4 Buzzer

CM4 Nano has a buzzer, which is controlled by GPIO6, enabled at high level and disabled at low level.

4.5 HDMI FPC

On the back of the development board, J13 uses CM4 HDMI1 signal, in the form of FPC, with USB 2.0 touch screen signal and PWM brightness level signal reserved on it, which can be connected to HDMI touch screen.

Pin	definition	Pin	definition
1	NC	21	GND
2	NC	22	HDMI1_CLKP
3	NC	23	HDMI1_CLKN
4	NC	24	GND
5	GND	25	BACKLIGHT_PWM
6	USB_DP	26	GND
7	USB_DM	27	GND
8	GND	28	GND
9	HDMI1_HPD	29	GND
10	HDMI1_SCL	30	GND
11	HDMI1_SDA	31	GND
12	GND	32	LCD_PWR_EN
13	HDMI1_TX2P	33	GND
14	HDMI1_TX2N	34	GND
15	GND	35	GND
16	HDMI1_TX1P	36	GND
17	HDMI1_TX1N	37	GND
18	GND	38	GND

	19	HDMI1_TX0P	39	GND
	20	HDMI1_TX0N	40	5V

5 Wireless Communication

5.1 WiFi

Customers can purchase CM4 Nano with WiFi version, which supports 2.4 GHz and 5.0 GHz IEEE 802.11b/G/N/AC dual-band WiFi.

2.4G band

parameter	Feature
frequency range	802.11b/g/n(HT20): 2412-2472MHz 802.11n(HT40): 2422-2462MHz
modulation system	802.11b:DSSS 802.11g/n:OFDM
Frequency Step	5M

5G band

parameter	Feature
frequency range	802.11a/n/ac: 5150-5350MHz 5470-5725MHz 5725-5850MHz
modulation system	BPSK
Frequency step	5M

5.2 Bluetooth

CM4 Nano support bluetooth 5.0.

parameter	Feature
frequency range	2402-2480MHz
modulation system	GFSK,DPSK
Frequency step	2M

5.3 Antenna

5.3.1 WiFi / BT Antenna

Parameter	Feature
Antenna type	External antenna
frequency band	2400-2500MHz, 5150-5850 MHz
antenna gain	2 dBi
impedance	50 OHM

6 Electrical Characteristics

6.1 Electrical Parameters

Parameters	Minimum	Typical	Max	Unit
System power input	7	12	18	V
Working temperature	-25	25	60	°C
Storage temperature	-25	25	60	°C
Working environment humidity	20		90	%

7 FAQ

1. Why do some functions fail after installing CM4 Industrial Edition in the official system?

We recommend that customers install the system image provided by us. Otherwise, please download our BSP to make some external interfaces work.

2.Can CM4 Nano be started in the micro SD card?

No, the micro SD card is only used for data storage. The operating system should be installed in eMMC.

3. Is there any signal occupied on the 40PIN on the CM4 Nano?

The buzzer has occupied GPIO6. If it is not needed, the resistor R39 can be removed and the GPIO6 can be disconnected from the buzzer circuit. The SD card occupies GPIO22,23,24,25,26,27. If you don't use it, please don't insert the SD card.

4.How to install a mirror?

You can refer to the instructions by reading the software manual.

5.How to solve the error "config failed, hub doesn't have any ports! (err -19) " when opening CM4 Nano?

Delete "otg_mode=1", [cm4] in config.txt and add "dtoverlay=dwc2,dr_mode=host"at the same time.

8 Product change record

9 About us

9.1 About EDATEC

EDATEC, located in Shanghai, is one of Raspberry Pi's global design partners. Our vision is to provide hardware solutions for Internet of Things, industrial control, automation, green energy and artificial intelligence based on Raspberry Pi technology platform.

We provide standard hardware solutions, customized design and manufacturing services to speed up the development and time to market of electronic products.

9.2 Contact us

Mail - sales@edatec.cn / support@edatec.cn

Phone - +86-18621560183

Website - <https://www.edatec.cn>

Address - Room 301, Building 24, No.1661 Jialuo Highway, Jiading District, Shanghai