

PART No. 1485FW2

for more information visit

www.hammfg.com

Data subject to change without notice

Isometric drawing Not to Scale

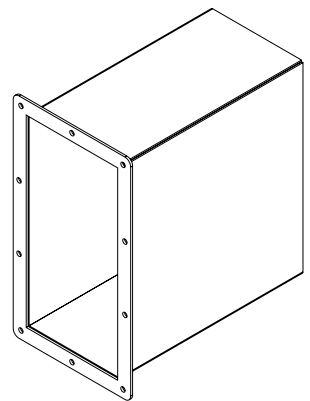

ISOMETRIC VIEW

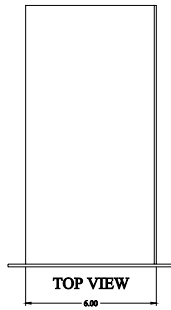

TOP VIEW

6.00

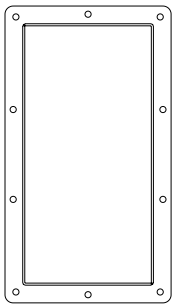

BACK VIEW

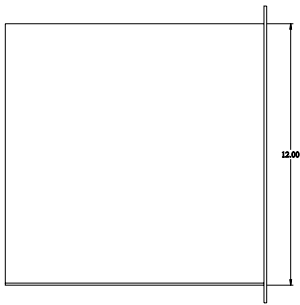

SIDE VIEW

12.00

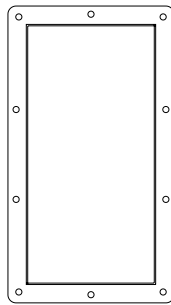

FRONT VIEW

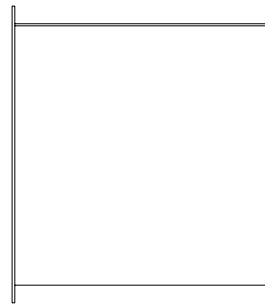

SIDE VIEW

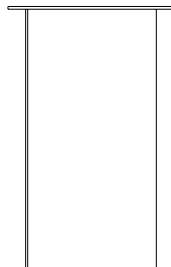

BOTTOM VIEW