

REV	CHANGE	DATE	DRN	CHK
	Drawn	12/28/16	SJ	T

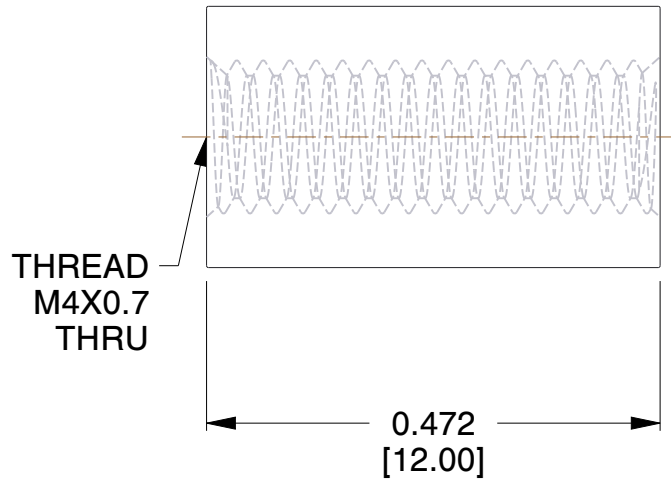
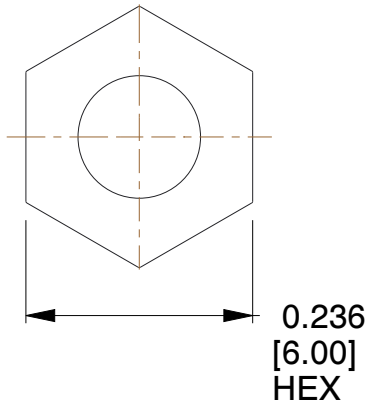
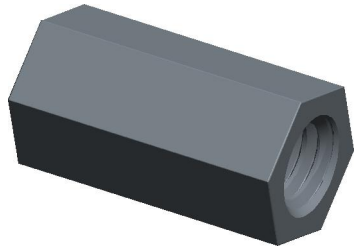

**NOTES:**

1. Material : Aluminium
2. Finish : No Plate
3. ASME Y14.5M - 2009
4. All Drawing Dimensions are in Inches [mm]
5. Unless otherwise specified; Edge Breaks, Radii or Countersinks 0.005-0.015

COMPONENT	STANDOFFS
<b>M1309-4007-AL</b>	<b>SCALE</b>
	5.00
	<b>SHEET</b>
6 MM HEX FEMALE STANDOFFS	1 of 1



95 Silvermine Rd., Seymour CT 06483  
Tel: 203-888-2133, Fax: 203-888-9860

This Drawing is the Property of RAF.  
It contains confidential, proprietary information that is RAF property. Do not disclose to or duplicate for others except as authorized by RAF.

**TOLERANCES**  
ALL DIMENSIONS ARE INCHES  
(UNLESS OTHERWISE SPECIFIED)  
**METALLIC**  
LENGTHS < / = 6 INCHES ± 0.005  
LENGTH > 6 INCHES ± 0.010  
DIAMETERS: ± 0.005  
**NON-METALLIC**  
LENGTH: ± 0.010 DIAMETERS: ± 0.010  
**INTERNAL THREADS:**  
MINIMUM THREAD DEPTH