

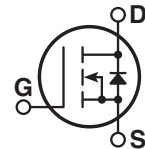

Super Junction MOSFET

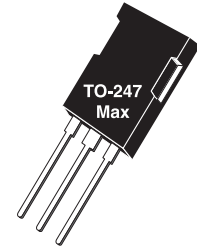

- Ultra Low $R_{DS(ON)}$
- Low Miller Capacitance
- Ultra Low Gate Charge, Q_g
- Avalanche Energy Rated
- Extreme dv/dt Rated
- Dual die (parallel)
- Popular T-MAX Package

Unless stated otherwise, Microsemi discrete MOSFETs contain a single MOSFET die. This device is made with two parallel MOSFET die. It is intended for switch-mode operation. It is not suitable for linear mode operation.

MAXIMUM RATINGS

All Ratings per die: $T_C = 25^\circ\text{C}$ unless otherwise specified.

Symbol	Parameter	APT106N60B2C6	UNIT
V_{DSS}	Drain-Source Voltage	600	Volts
I_D	Continuous Drain Current @ $T_C = 25^\circ\text{C}$ ①	106	Amps
	Continuous Drain Current @ $T_C = 100^\circ\text{C}$	68	
I_{DM}	Pulsed Drain Current ②	318	
V_{GS}	Gate-Source Voltage Continuous	± 20	Volts
P_D	Total Power Dissipation @ $T_C = 25^\circ\text{C}$	833	Watts
T_J, T_{STG}	Operating and Storage Junction Temperature Range	-55 - to 150	$^\circ\text{C}$
T_L	Lead Temperature: 0.063" from Case for 10 Sec.	260	
I_{AR}	Avalanche Current ②	18.6	Amps
E_{AR}	Repetitive Avalanche Energy ③ ($I_D = 18.6\text{A}, V_{DD} = 50\text{V}$)	3.4	mJ
E_{AS}	Single Pulse Avalanche Energy ($I_D = 18.6\text{A}, V_{DD} = 50\text{V}$)	2200	

STATIC ELECTRICAL CHARACTERISTICS

Symbol	Characteristic / Test Conditions	MIN	TYP	MAX	UNIT
$BV_{(DSS)}$	Drain-Source Breakdown Voltage ($V_{GS} = 0\text{V}, I_D = 500\mu\text{A}$)	600			Volts
$R_{DS(on)}$	Drain-Source On-State Resistance ④ ($V_{GS} = 10\text{V}, I_D = 53\text{A}$)			0.035	Ohms
I_{DSS}	Zero Gate Voltage Drain Current ($V_{DS} = 600\text{V}, V_{GS} = 0\text{V}$)			50	μA
	Zero Gate Voltage Drain Current ($V_{DS} = 600\text{V}, V_{GS} = 0\text{V}, T_C = 150^\circ\text{C}$)			500	
I_{GSS}	Gate-Source Leakage Current ($V_{GS} = \pm 20\text{V}, V_{DS} = 0\text{V}$)			± 200	nA
$V_{GS(th)}$	Gate Threshold Voltage ($V_{DS} = V_{GS}, I_D = 3.4\text{mA}$)	2.5	3	3.5	Volts

 CAUTION: These Devices are Sensitive to Electrostatic Discharge. Proper Handling Procedures Should Be Followed.

"COOLMOS™ comprise a new family of transistors developed by Infineon Technologies AG. "COOLMOS" is a trademark of Infineon Technologies AG."

Microsemi Website - <http://www.microsemi.com>

DYNAMIC CHARACTERISTICS

APT106N60B2C6

Symbol	Characteristic	Test Conditions	MIN	TYP	MAX	UNIT
C _{iss}	Input Capacitance	V _{GS} = 0V V _{DS} = 25V f = 1 MHz		8390		pF
C _{oss}	Output Capacitance			7115		
C _{rss}	Reverse Transfer Capacitance			229		
Q _g	Total Gate Charge ^⑤	V _{GS} = 10V V _{DD} = 300V I _D = 106A @ 25°C		308		nC
Q _{gs}	Gate-Source Charge			50		
Q _{gd}	Gate-Drain ("Miller") Charge			160		
t _{d(on)}	Turn-on Delay Time	INDUCTIVE SWITCHING V _{GS} = 15V V _{DD} = 400V I _D = 106A @ 25°C R _G = 4.3Ω		25		ns
t _r	Rise Time			79		
t _{d(off)}	Turn-off Delay Time			277		
t _f	Fall Time			164		
E _{on}	Turn-on Switching Energy ^⑥	INDUCTIVE SWITCHING @ 25°C V _{DD} = 400V, V _{GS} = 15V I _D = 106A, R _G = 4.3Ω		2995		μJ
E _{off}	Turn-off Switching Energy			3775		
E _{on}	Turn-on Switching Energy ^⑥	INDUCTIVE SWITCHING @ 125°C V _{DD} = 400V, V _{GS} = 15V I _D = 106A, R _G = 4.3Ω		4055		
E _{off}	Turn-off Switching Energy			4200		

SOURCE-DRAIN DIODE RATINGS AND CHARACTERISTICS

Symbol	Characteristic / Test Conditions	MIN	TYP	MAX	UNIT
I _S	Continuous Source Current (Body Diode)			92	Amps
I _{SM}	Pulsed Source Current ^② (Body Diode)			318	
V _{SD}	Diode Forward Voltage ^④ (V _{GS} = 0V, I _S = -106A)		0.9	1.2	Volts
dv/dt	Peak Diode Recovery dv/dt ^⑦			15	V/ns
t _{rr}	Reverse Recovery Time (I _S = -106A, di/dt = 100A/μs)	T _J = 25°C		1400	ns
Q _{rr}	Reverse Recovery Charge (I _S = -106A, di/dt = 100A/μs)	T _J = 25°C		45	μC
I _{RRM}	Peak Recovery Current (I _S = -106A, di/dt = 100A/μs)	T _J = 25°C		47	Amps

THERMAL CHARACTERISTICS

Symbol	Characteristic	MIN	TYP	MAX	UNIT
R _{θJC}	Junction to Case			0.15	°C/W
R _{θJA}	Junction to Ambient			40	

- 1 Continuous current limited by package lead temperature.
- 2 Repetitive Rating: Pulse width limited by maximum junction temperature
- 3 Repetitive avalanche causes additional power losses that can be calculated as $P_{AV} = E_{AR} \cdot f$. Pulse width tp limited by Tj max.
- 4 Pulse Test: Pulse width < 380 μs, Duty Cycle < 2%
- 5 See MIL-STD-750 Method 3471
- 6 Eon includes diode reverse recovery.
- 7 Maximum 125°C diode commutation speed = di/dt 600A/μs

Microsemi reserves the right to change, without notice, the specifications and information contained herein.

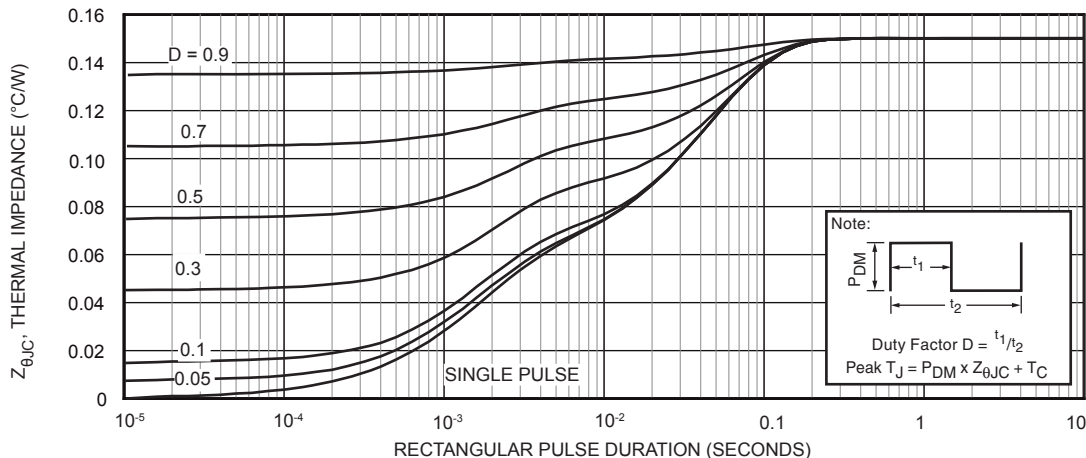

Figure 1, Maximum Effective Transient Thermal Impedance, Junction-To-Case vs Pulse Duration

Typical Performance Curves

APT106N60B2C6

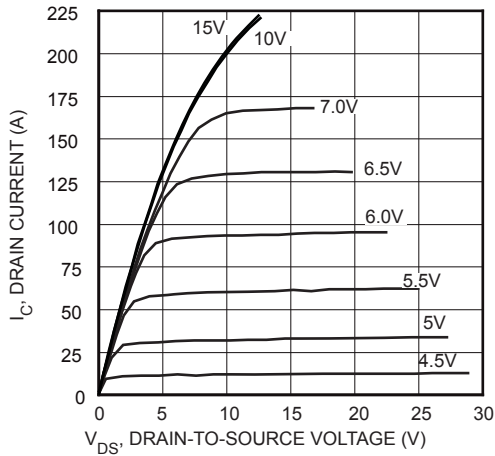

FIGURE 2, Low Voltage Output Characteristics

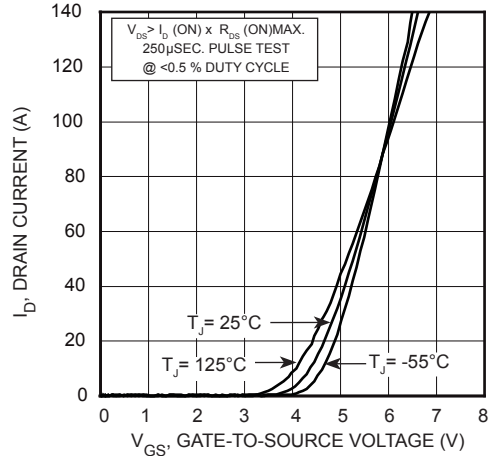

FIGURE 3, Transfer Characteristics

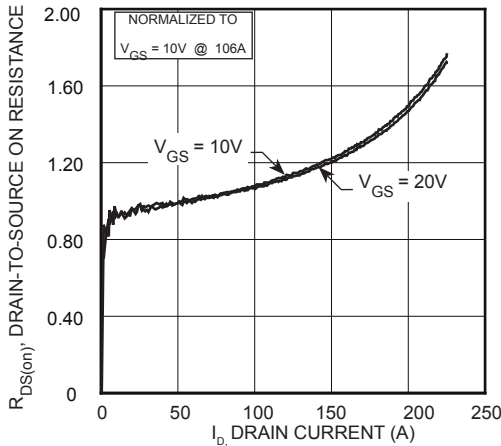

FIGURE 4, $R_{DS(ON)}$ vs Drain Current

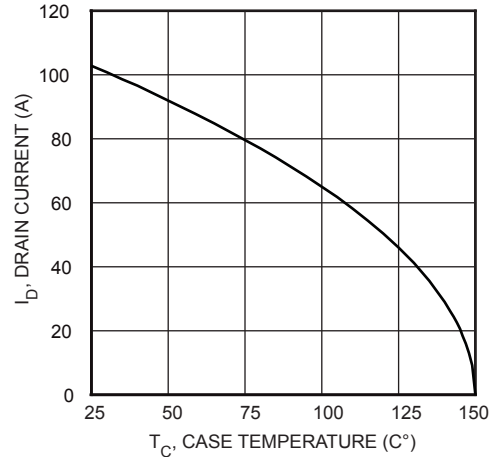

FIGURE 5, Maximum Drain Current vs Case Temperature

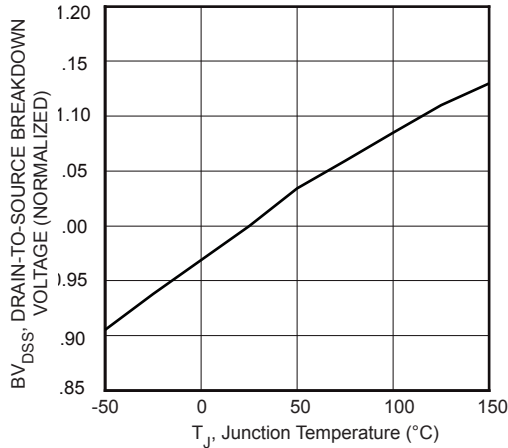

FIGURE 6, Breakdown Voltage vs Temperature

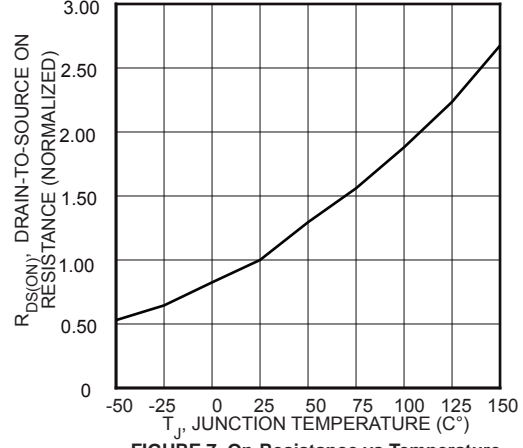

FIGURE 7, On-Resistance vs Temperature

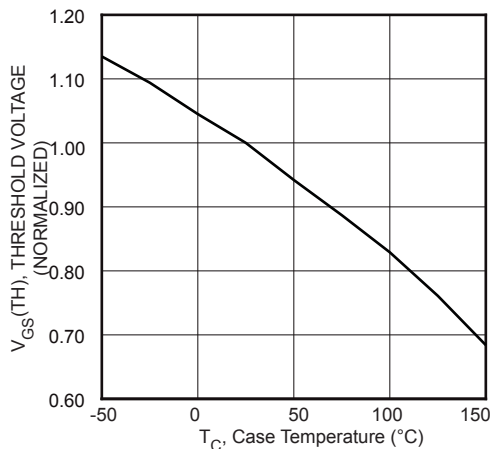

FIGURE 8, Threshold Voltage vs Temperature

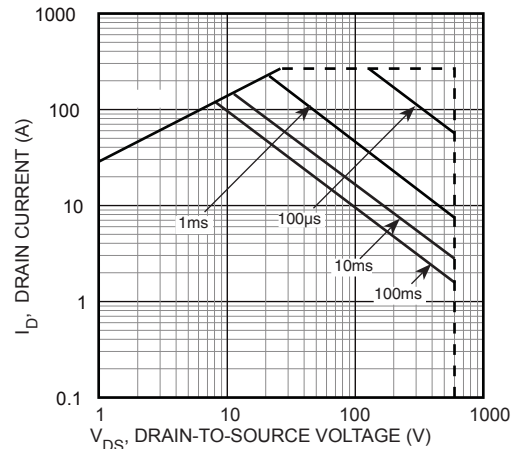

FIGURE 9, Maximum Safe Operating Area

Typical Performance Curves

APT106N60B2C6

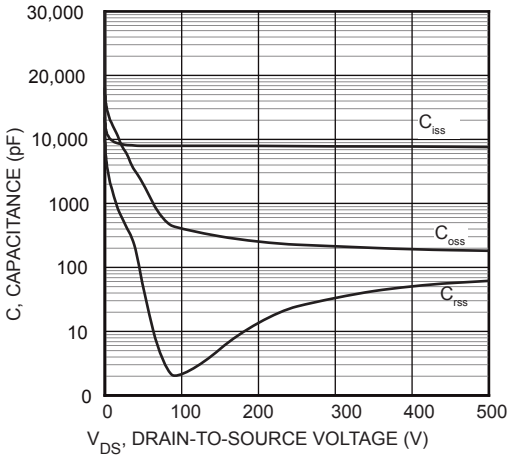

FIGURE 10, Capacitance vs Drain-To-Source Voltage

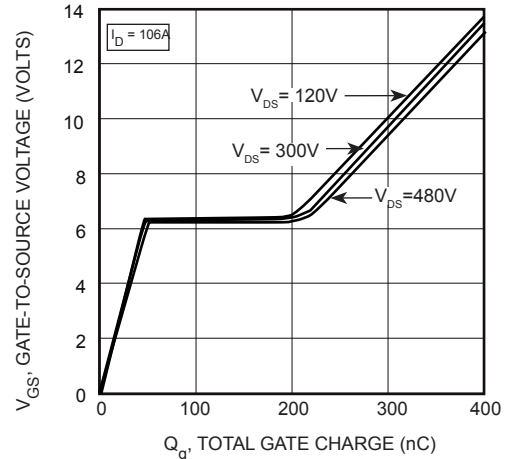

FIGURE 11, Gate Charges vs Gate-To-Source Voltage

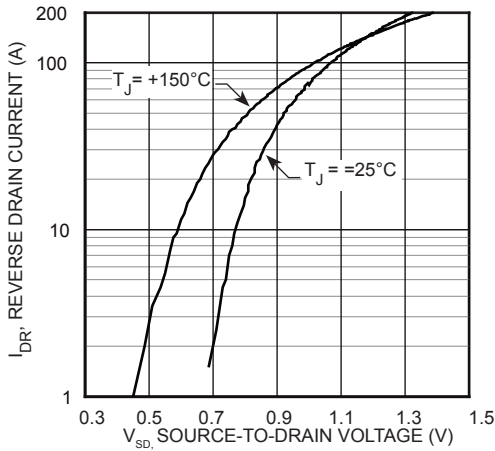

FIGURE 12, Source-Drain Diode Forward Voltage

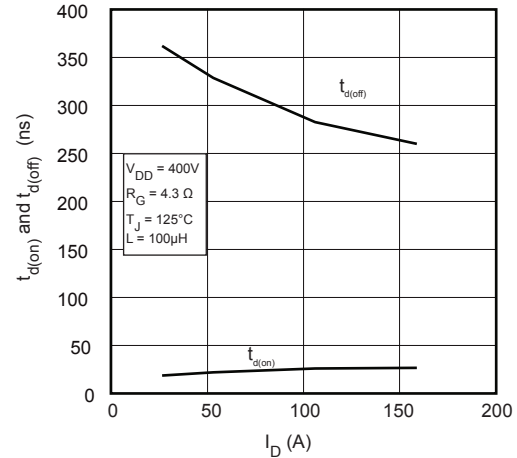

FIGURE 13, Delay Times vs Current

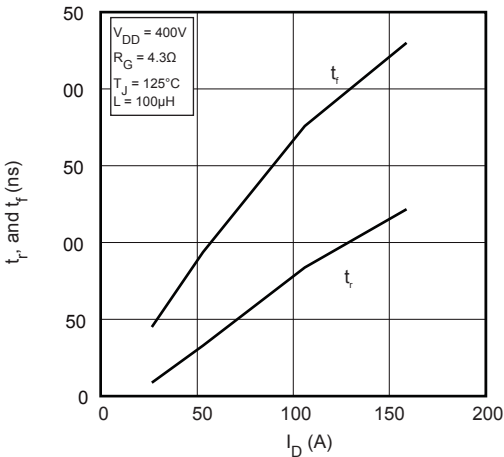

FIGURE 14, Rise and Fall Times vs Current

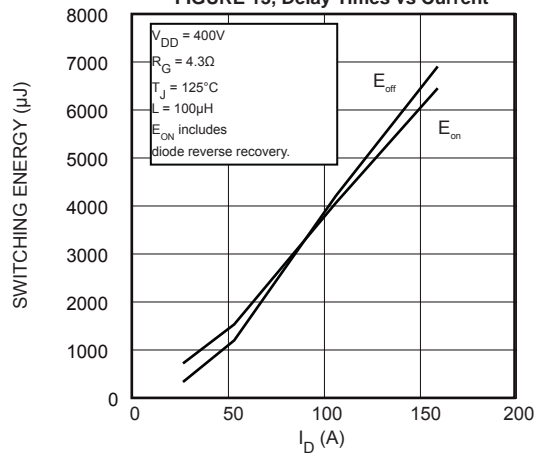

FIGURE 15, Switching Energy vs Current

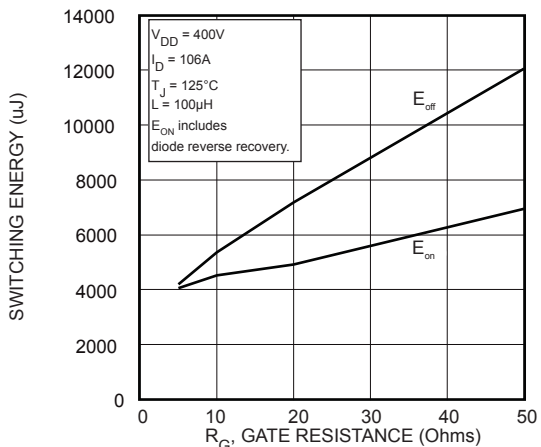

FIGURE 16, Switching Energy vs Gate Resistance

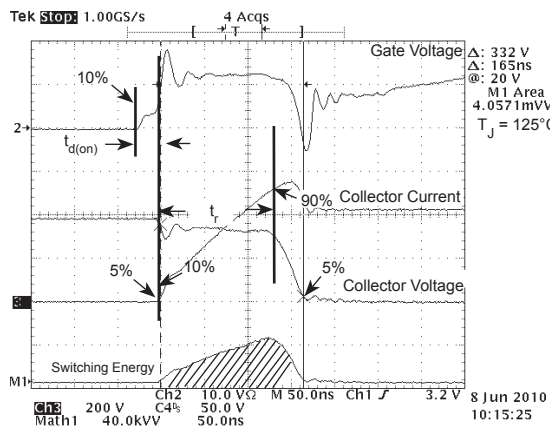

Figure 17, Turn-on Switching Waveforms and Definitions

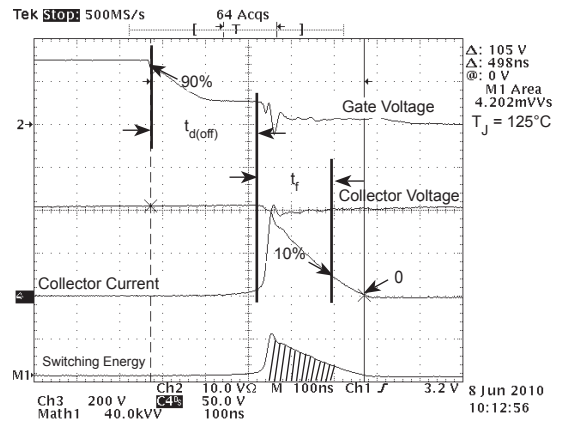

Figure 18, Turn-off Switching Waveforms and Definitions

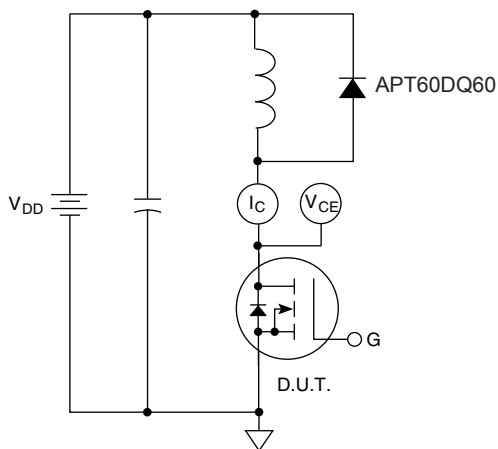
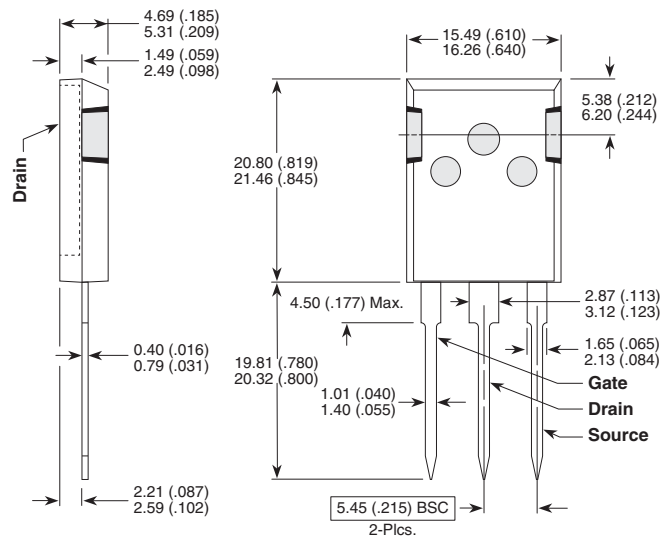

Figure 19, Inductive Switching Test Circuit

T-MAX™ (B2) Package Outline

100% Sn Plated



These dimensions are equal to the TO-247 without the mounting hole.

Dimensions in Millimeters and (Inches)

Microsemi's products are covered by one or more of U.S. patents 4,895,810 5,045,903 5,089,434 5,182,234 5,019,522 5,262,336 6,503,786 5,256,583 4,748,103 5,283,202 5,231,474 5,434,095 5,528,058 6,939,743, 7,352,045 5,283,201 5,801,417 5,648,283 7,196,634 6,664,594 7,157,886 6,939,743 7,342,262 and foreign patents. US and Foreign patents pending. All Rights Reserved.