

# 10x3.2x0.5 ISM 868 MHz Chip Antenna (AA067)

## Engineering Specification

### 1. Explanation of Product Number

H 2 U 6 4 H 1 H 2 B 0 1 0 0



### 2. Features

- \*Stable and reliable in performances
- \*Low temperature coefficient of frequency
- \*Low profile, compact size
- \*RoHS 2.0 compliance
- \*SMT processes compatible
- \*AEC-Q200 compliant

### 3. Applications

- \*ISM Band system.
- \*RFID system

### 4. Description

Unictron's chip antenna series are specially designed for ISM Band applications. Based on Unictron's proprietary design and processes, this chip antenna has excellent stability and sensitivity to consistently provide high signal reception efficiency.



詠業科技股份有限公司  
Unictron Technologies Corporation  
Website: www.unictron.com

THIS DRAWINGS AND SPECIFICATIONS ARE THE PROPERTY OF UNICTRON TECHNOLOGIES CORPORATION AND SHALL NOT BE REPRODUCED OR USED AS THE BASIS FOR THE MANUFACTURE OR SALE OF APPARATUS OR DEVICES WITHOUT PERMISSION

Prepared by : Betty

Designed by : Sam

Checked by : Mike

Approved by : Herbert

TITLE : ISM 868 MHz Chip Antenna (AA067)  
Engineering Specification

DOCUMENT NO.

H2U64H1H2B0100

REV.  
B

## 5. Electrical Specifications (80x40(mm) ground plane)

### 5-1. Electrical Table:

Characteristics		Specifications	Unit
Outline Dimensions		10x3.2x0.5	mm
Ground Plane		80x40	mm
Center Frequency*		868	MHz
Impedance		50	$\Omega$
Polarization		Linear Polarization	
Gain	Peak	0.34(typical**)	dBi
	Efficiency	58 (typical**)	%
Temperature Coefficient of Frequency		0±20 max (@ -20°C~80°C)	ppm/°C

\*Center frequency means the frequency with the lowest value in return loss of the chip antenna on the evaluation board..

\*\*A typical value is for reference only, not guaranteed.

### 5-2. Return Loss & VSWR

Return Loss (S<sub>11</sub>)

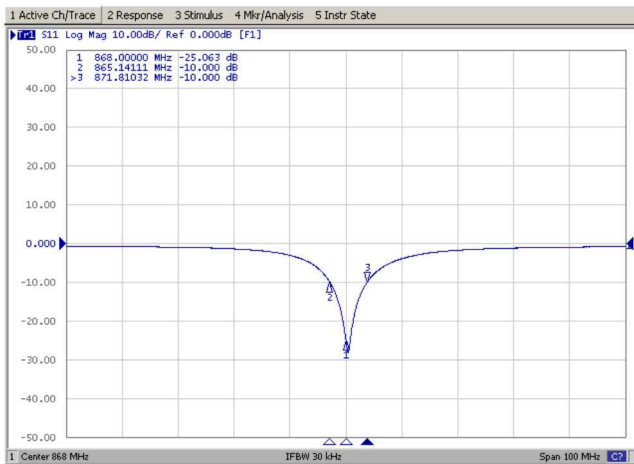

VSWR (S<sub>11</sub>)

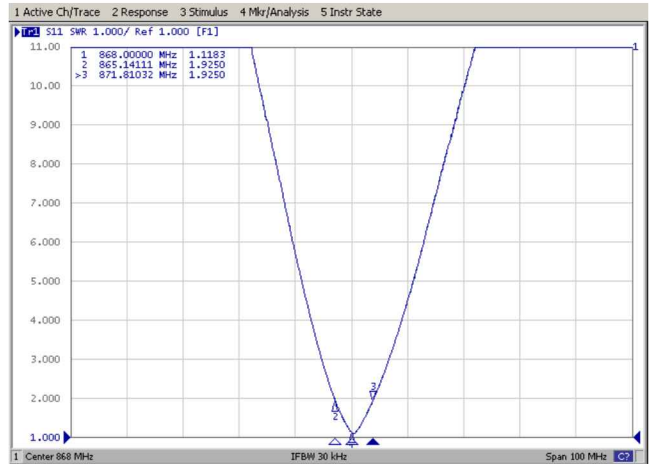

詠業科技股份有限公司  
Unictron Technologies Corporation  
Website: www.unictron.com

THIS DRAWINGS AND SPECIFICATIONS ARE THE PROPERTY OF UNICTRON TECHNOLOGIES CORPORATION AND SHALL NOT BE REPRODUCED OR USED AS THE BASIS FOR THE MANUFACTURE OR SALE OF APPARATUS OR DEVICES WITHOUT PERMISSION

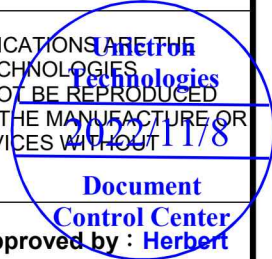

Prepared by : Betty

Designed by : Sam

Checked by : Mike

Approved by : Herbert

TITLE : ISM 868 MHz Chip Antenna (AA067)  
Engineering Specification

DOCUMENT NO.

H2U64H1H2B0100

REV.  
B

## 6. Antenna Dimensions & Test Board (unit: mm)

### 6-1. Antenna Dimensions

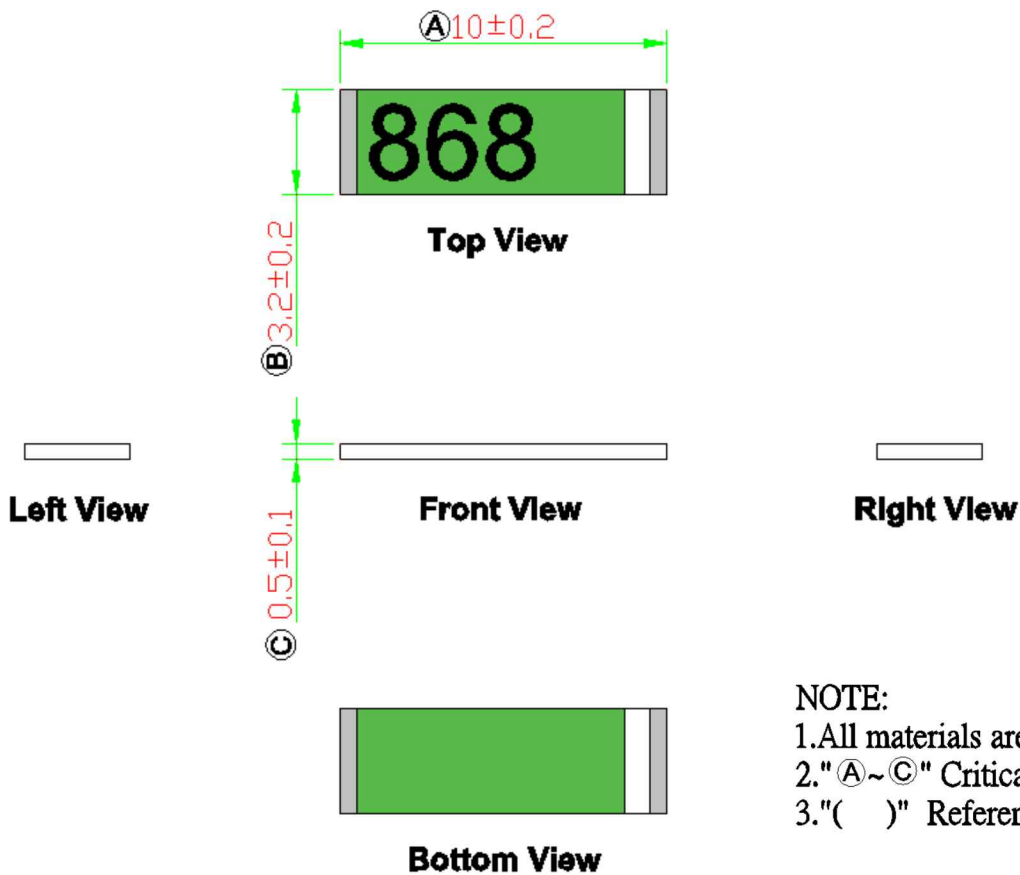

**NOTE:**

1. All materials are RoHS 2.0 compliant.
2. "A~C" Critical Dimensions.
3. "( )" Reference Dimensions.

### PIN Definitions



PIN	1	2
Soldering PAD	Signal	Tuning / Ground



詠業科技股份有限公司  
Unictron Technologies Corporation  
Website: www.unictron.com

THIS DRAWINGS AND SPECIFICATIONS ARE THE PROPERTY OF UNICTRON TECHNOLOGIES CORPORATION AND SHALL NOT BE REPRODUCED OR USED AS THE BASIS FOR THE MANUFACTURE OR SALE OF APPARATUS OR DEVICES WITHOUT PERMISSION

Document  
Control Center  
2022/11/8

Prepared by : Betty

Designed by : Sam

Checked by : Mike

Approved by : Herbert

TITLE : ISM 868 MHz Chip Antenna (AA067)  
Engineering Specification

DOCUMENT  
NO.

H2U64H1H2B0100

REV.  
B

6-2. Test Board with Antenna

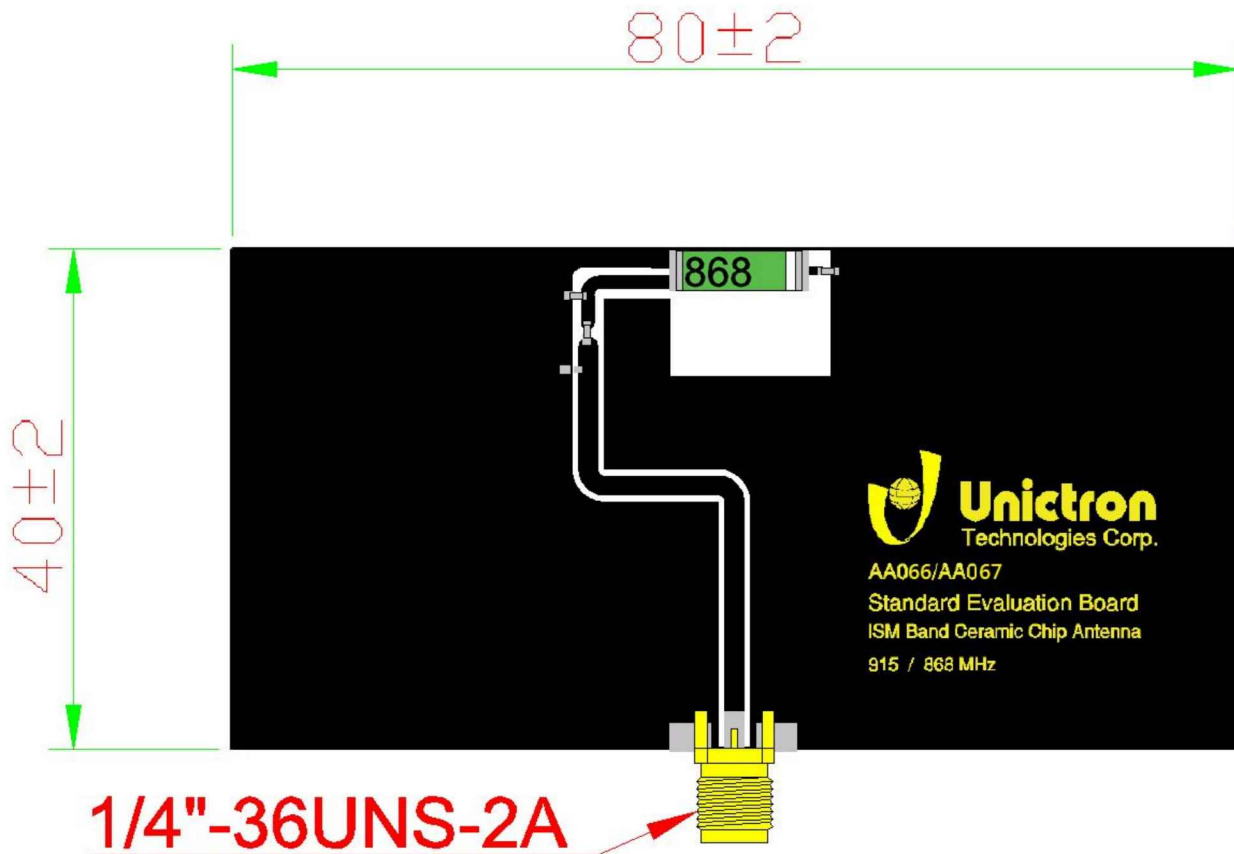

Unit : mm



詠業科技股份有限公司  
Unictron Technologies Corporation  
Website: www.unictron.com

THIS DRAWINGS AND SPECIFICATIONS ARE THE PROPERTY OF UNICTRON TECHNOLOGIES CORPORATION AND SHALL NOT BE REPRODUCED OR USED AS THE BASIS FOR THE MANUFACTURE OR SALE OF APPARATUS OR DEVICES WITHOUT PERMISSION

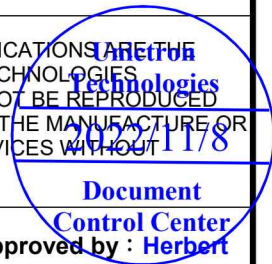

Prepared by : Betty      Designed by : Sam      Checked by : Mike      Approved by : Herbert

TITLE : ISM 868 MHz Chip Antenna (AA067) Engineering Specification	DOCUMENT NO.	H2U64H1H2B0100	REV.
			B



## 7. Radiation Pattern (80x40(mm) ground plane)

### 7-1. 3D Gain Pattern (Radiation Pattern at 868 MHz)

7-2

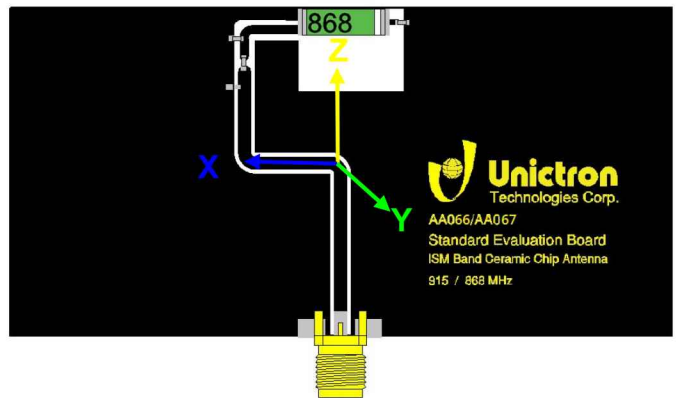
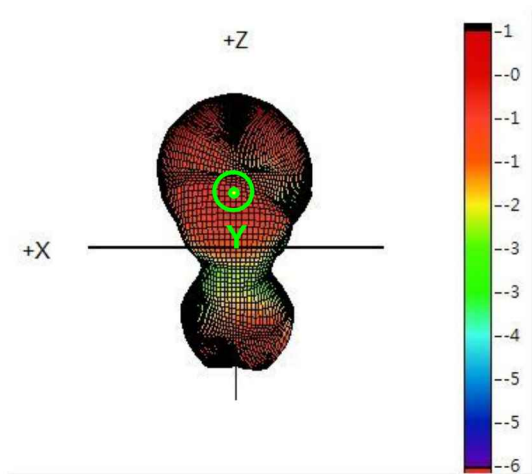
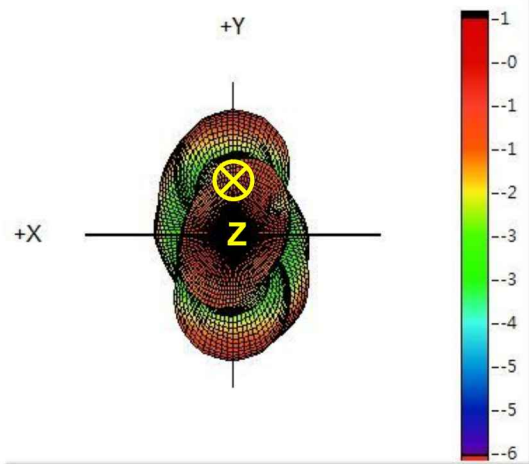
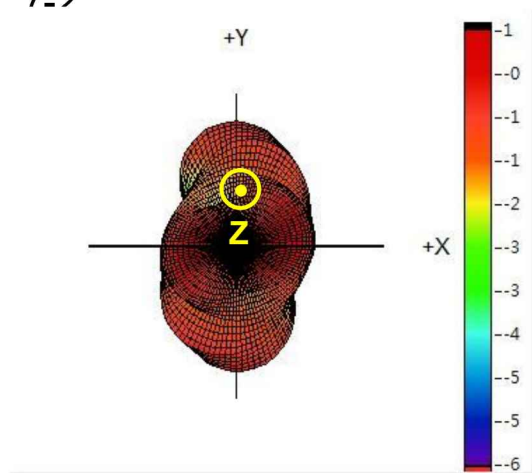

詠業科技股份有限公司  
Unictron Technologies Corporation  
Website: www.unictron.com

THIS DRAWINGS AND SPECIFICATIONS ARE THE PROPERTY OF UNICTRON TECHNOLOGIES CORPORATION AND SHALL NOT BE REPRODUCED OR USED AS THE BASIS FOR THE MANUFACTURE OR SALE OF APPARATUS OR DEVICES WITHOUT PERMISSION

Prepared by : Betty

Designed by : Sam

Checked by : Mike

Approved by : Herbert

TITLE : ISM 868 MHz Chip Antenna (AA067)  
Engineering Specification

DOCUMENT  
NO.

H2U64H1H2B0100

REV.

B

### 7-2. 3D Efficiency Table

Frequency (MHz)	856	857	858	859	860	861	862	863	864	865	866	867	868
Efficiency (dB)	-7.3	-6.8	-6.3	-5.9	-5.4	-4.9	-4.4	-4.3	-3.8	-3.4	-3.0	-2.6	-2.4
Efficiency (%)	18.9	20.9	23.3	26.0	29.0	32.4	36.1	37.1	41.3	45.6	50.1	54.4	58.3
Gain (dBi)	-4.6	-4.3	-3.9	-3.4	-2.6	-2.2	-1.9	-1.6	-1.0	-0.7	-0.2	0.2	0.3

Frequency (MHz)	869	870	871	872	873	874	875	876	877	878	879	880
Efficiency (dB)	-2.1	-2.0	-2.0	-2.1	-2.2	-2.4	-2.6	-2.7	-3.1	-3.5	-3.9	-4.4
Efficiency (%)	61.2	62.7	63.2	62.3	60.2	57.2	55.2	53.6	49.0	44.6	40.5	36.7
Gain (dBi)	0.3	0.2	0.2	0.2	0.1	-0.1	-0.1	-0.2	-0.5	-0.9	-1.3	-1.8

### 7-3. 3D Efficiency vs. Frequency

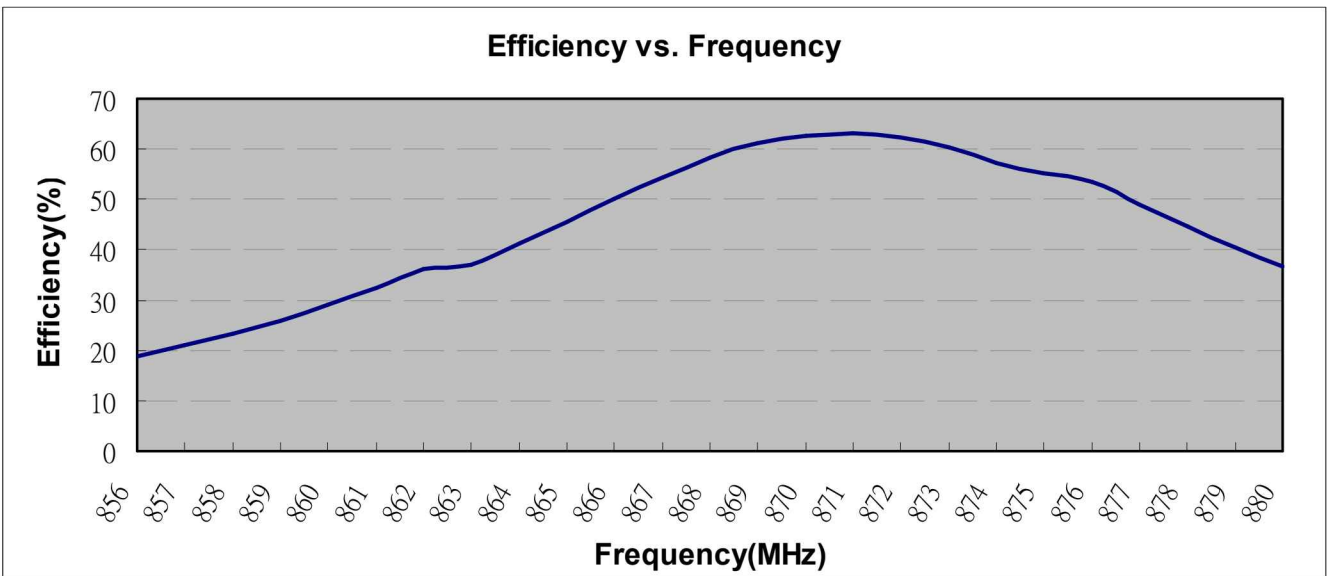

詠業科技股份有限公司  
 Unictron Technologies Corporation  
 Website: www.unictron.com

THIS DRAWINGS AND SPECIFICATIONS ARE THE PROPERTY OF UNICTRON TECHNOLOGIES CORPORATION AND SHALL NOT BE REPRODUCED OR USED AS THE BASIS FOR THE MANUFACTURE OR SALE OF APPARATUS OR DEVICES WITHOUT PERMISSION

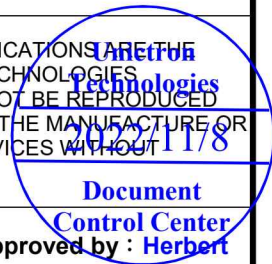

Prepared by : Betty      Designed by : Sam      Checked by : Mike      Approved by : Herbert

TITLE : ISM 868 MHz Chip Antenna (AA067) Engineering Specification	DOCUMENT NO.	H2U64H1H2B0100	REV.
			B

## 8. Layout Guide:

### a. Solder Land Pattern:

Land pattern for soldering (black marking areas) is as shown below. Matching circuit is needed for good performance, when customer's device is different.

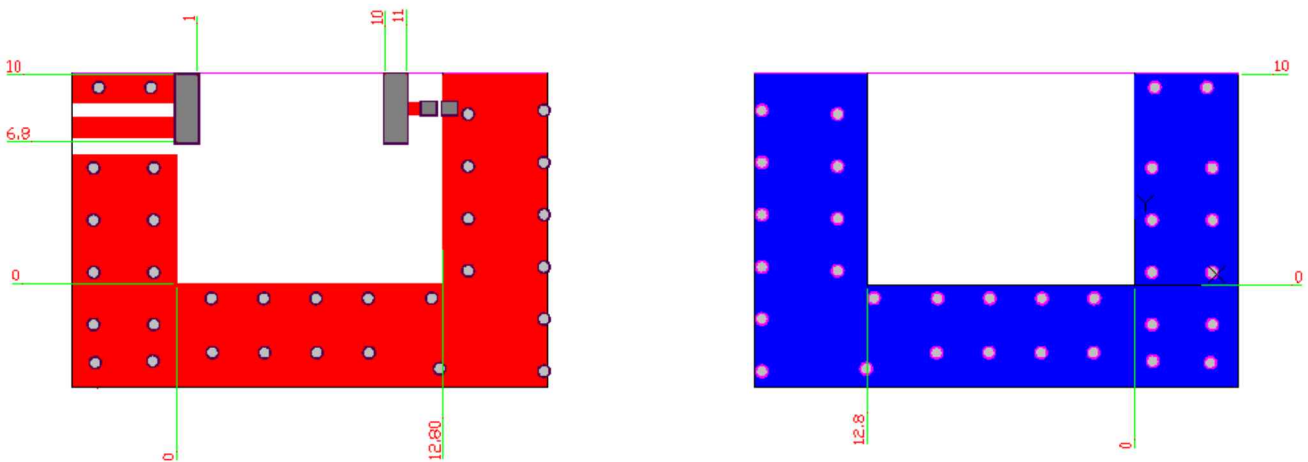

### b. Matching circuit :

(Center frequency is about 868 MHz @ 80 x 40 mm<sup>2</sup> Evaluation Board)

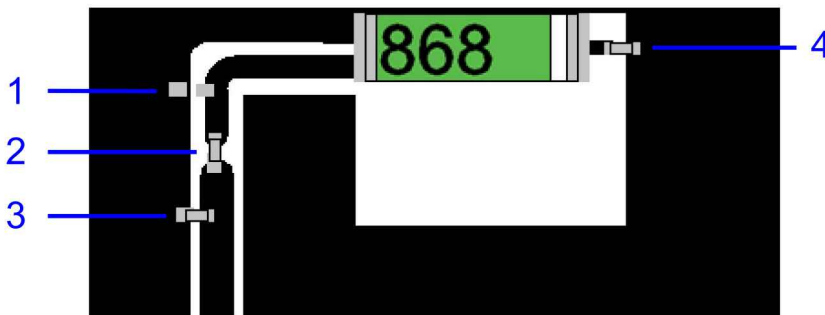

詠業科技股份有限公司  
Unictron Technologies Corporation  
Website: www.unictron.com

THIS DRAWINGS AND SPECIFICATIONS ARE THE PROPERTY OF UNICTRON TECHNOLOGIES CORPORATION AND SHALL NOT BE REPRODUCED OR USED AS THE BASIS FOR THE MANUFACTURE OR SALE OF APPARATUS OR DEVICES WITHOUT PERMISSION

Prepared by : Betty

Designed by : Sam

Checked by : Mike

Approved by : Herbert

TITLE : ISM 868 MHz Chip Antenna (AA067)  
Engineering Specification

DOCUMENT  
NO.

H2U64H1H2B0100

REV.  
B

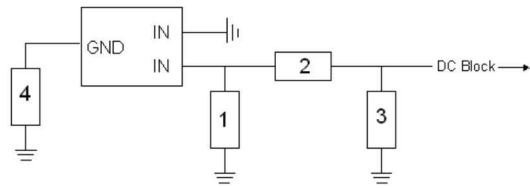

System Matching Circuit Component			
Location	Description	Vendor	Tolerance
1	N/A*	-	-
2	0Ω*	(0402)	-
3	3.3pF*	Murata (0402)	±0.05 pF
4	12pF*	Murata (0402)	±0.5 %

\*Typical reference values which may need to be changed when circuit boards or part vendors are different.

## 9. Soldering Conditions:

### a. Typical Soldering Profile for Lead-free Process

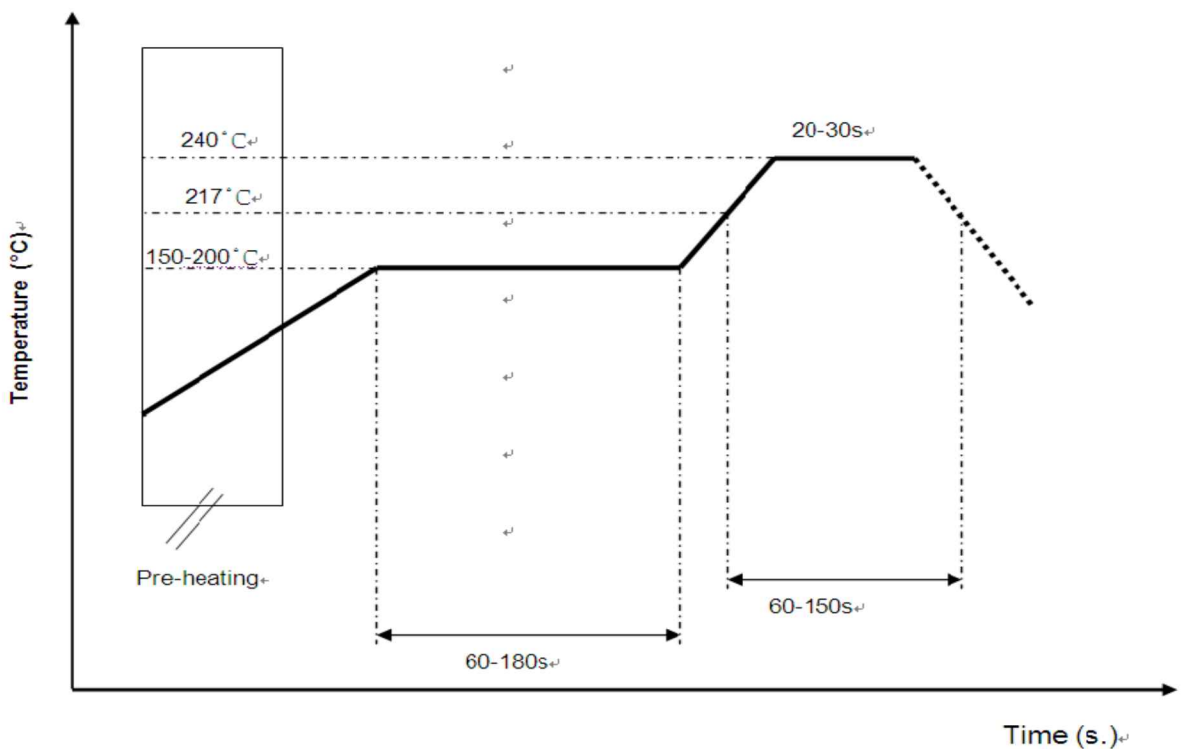

\*Recommended solder paste alloy: SAC305 (Sn96.5 /Ag3 /Cu0.5) Lead Free solder paste.

## 10. Reminders for users of Unictron's chip antennas

- Since Unictron's chip antennas are made of ceramic materials which show different rigidity than circuit board materials, bending of circuit board at the locations where chip antennas are mounted may cause the cracking of solder joints or antenna itself.
- Any connecting strip which will be cut off at PCB assembly process shall be located



詠業科技股份有限公司  
Unictron Technologies Corporation  
Website: www.unictron.com

THIS DRAWINGS AND SPECIFICATIONS ARE THE PROPERTY OF UNICTRON TECHNOLOGIES CORPORATION AND SHALL NOT BE REPRODUCED OR USED AS THE BASIS FOR THE MANUFACTURE OR SALE OF APPARATUS OR DEVICES WITHOUT PERMISSION

Prepared by : Betty

Designed by : Sam

Checked by : Mike

Approved by : Herbert

TITLE : ISM 868 MHz Chip Antenna (AA067)  
Engineering Specification

DOCUMENT NO.

H2U64H1H2B0100

REV.  
B



away from the installation site of chip antenna. Punching of the connecting strip may cause severe bending of the circuit board and cracking of solder joint or chip antenna itself may occur.

- c. Be cautious when ultrasonic welding process needs to be used near the locations where chip antennas are installed. Strong ultrasonic vibration may cause the cracking of chip antenna solder joints.

## 11. Packing:

- (1) Unit Weight: 0.05±0.005(g) /pcs
- (2) Quantity/Reel: 6000pcs/Reel
- (3) Plastic tape: Black Conductive Polystyrene

a. Tape Drawing

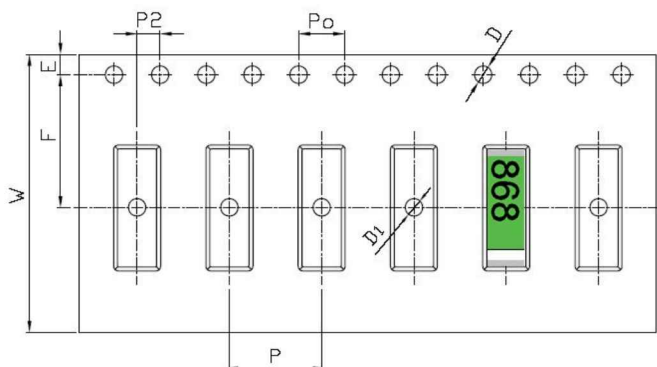

b. Tape Dimensions (unit: mm)

Feature	Specifications	Tolerances
W	24.00	±0.30
P	8.00	±0.10
E	1.75	±0.10
F	11.50	±0.10
P2	2.00	±0.10
D	1.50	+0.10 0.00
D1	1.50	±0.10
Po	4.00	±0.10
10Po	40.00	±0.20

c. Reel Dimensions (unit: mm)



詠業科技股份有限公司  
Unictron Technologies Corporation  
Website: www.unictron.com

THIS DRAWINGS AND SPECIFICATIONS ARE THE PROPERTY OF UNICTRON TECHNOLOGIES CORPORATION AND SHALL NOT BE REPRODUCED OR USED AS THE BASIS FOR THE MANUFACTURE OR SALE OF APPARATUS OR DEVICES WITHOUT PERMISSION

Prepared by : Betty

Designed by : Sam

Checked by : Mike

Approved by : Herbert

TITLE : ISM 868 MHz Chip Antenna (AA067)  
Engineering Specification

DOCUMENT NO.

H2U64H1H2B0100

REV.  
B

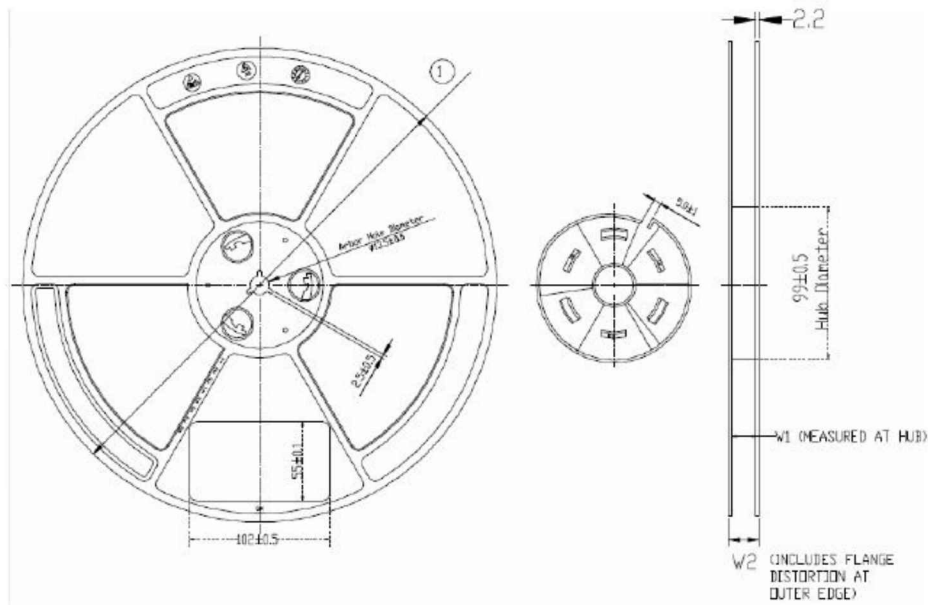

	直徑	內徑	外徑
	①	W1	W2
13"12MMCSBY(12.6)	330±1	13.4±1	17.8±1
13"24MMCSBY(24.6)	330±1	25.4±1	29.8±1

## 12. Operating & Storage Conditions

### 12-1. Operating

- (1) Maximum Input Power: 2 W
- (2) Operating Temperature: -40°C to 85°C
- (3) Relative Humidity: 10% to 70%

### 12-2. Storage (sealed)

- (1) Storage Temperature: -5°C to 40°C
- (2) Relative Humidity: 20% to 70%
- (3) Shelf Life: 1 year

### 12-3. Storage (After mounted on customer's PCB with SMT process)

- (1) Storage Temperature: -40°C to 85°C
- (2) Relative Humidity: 10% to 70%



詠業科技股份有限公司  
Unictron Technologies Corporation  
Website: www.unictron.com

THIS DRAWINGS AND SPECIFICATIONS ARE THE PROPERTY OF UNICTRON TECHNOLOGIES CORPORATION AND SHALL NOT BE REPRODUCED OR USED AS THE BASIS FOR THE MANUFACTURE OR SALE OF APPARATUS OR DEVICES WITHOUT PERMISSION

Prepared by : Betty

Designed by : Sam

Checked by : Mike

Approved by : Herbert

TITLE : ISM 868 MHz Chip Antenna (AA067)  
Engineering Specification

DOCUMENT  
NO.

H2U64H1H2B0100

REV.  
B

### 13. Notice

(1) Installation Guide:

Please refer to Unictron's application note "General guidelines for the installation of Unictron's chip antennas" for further information.

(2) All specifications are subject to change without notice.



詠業科技股份有限公司  
Unictron Technologies Corporation  
Website:www.unictron.com

THIS DRAWINGS AND SPECIFICATIONS ARE THE PROPERTY OF UNICTRON TECHNOLOGIES CORPORATION AND SHALL NOT BE REPRODUCED OR USED AS THE BASIS FOR THE MANUFACTURE OR SALE OF APPARATUS OR DEVICES WITHOUT PERMISSION

Prepared by : Betty

Designed by : Sam

Checked by : Mike

Approved by : Herbert

TITLE : ISM 868 MHz Chip Antenna (AA067)  
Engineering Specification

DOCUMENT NO.

H2U64H1H2B0100

REV.  
B