

SMD Auto X7R HV Flex, Ceramic, 0.15 uF, 10%, 630 VDC, X7R, SMD, MLCC, FT-CAP, Automotive Grade, 1812

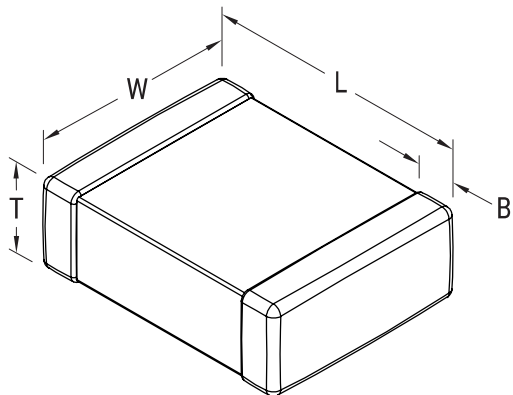

Dimensions

L	4.5mm +/-0.4mm
W	3.2mm +/-0.3mm
T	1.7mm +/-0.20mm
B	0.7mm +/-0.35mm

Packaging Specifications

Packaging:	T&R, 180mm, Plastic Tape
Packaging Quantity:	1000

General Information

Supplier:	KEMET
Series:	SMD Auto X7R HV Flex
Style:	SMD Chip
Description:	SMD, MLCC, FT-CAP, Automotive Grade
Features:	FT-CAP, Automotive Grade
RoHS:	Yes
Termination:	Flexible Termination
Marking:	No
Qualifications:	AEC-Q200
AEC-Q200:	Yes
Miscellaneous:	Note: Referee time for X7R dielectric for this part number is 1000 hours
Chip Size:	1812

Specifications

Capacitance:	0.15 uF
Capacitance Tolerance:	10%
Voltage DC:	630 VDC
Dielectric Withstanding Voltage:	945 V
Temperature Range:	-55/+125C
Temperature Coefficient:	X7R
Dissipation Factor:	2.50% 1kHz 25C
Aging Rate:	3% Loss/Decade Hour
Insulation Resistance:	667 MOhms