

DETAILS

Product Number	C13936_STRADA-2X2-B2-STP
Family	Strada
Type	Lens
Color	clear
Diameter	50 x 50 mm
Height	5,18 mm
Style	square
Optic Material	PMMA
Holder Material	
Fastening	pin, screw
Status	production ready
ROHS Compliant	Yes
Date Updated	23/08/2016



OPTICAL PROPERTIES

LED	Viewing Angle	Light Beam	Efficiency	cd/lm	Connector
XP-G2	119+43 deg	Streetligh...	93 %	0.580	-
XP-L HI	117+40 deg	Streetligh...	93 %	0.590	-
XP-G3	118+45 deg	Streetligh...	94 %	0.560	-
H35C1 (LEMWA33)	119+44 deg	Streetligh...	94 %	0.560	-
LUXEON TX	117+43 deg	Streetligh...	93 %	0.590	-
NVSxE21A	116+51 deg	Streetligh...	93 %	0.700	-
NVSW3x9A	119+49 deg	Streetligh...	94 %	0.530	-
Oslon Square PC	120+48 deg	Streetligh...	94 %	0.560	-
Oslon Square Gen3	118+43 deg	Streetligh...	93 %	0.580	-
Fortimo FastFlex LED board 2x8 DA G4	120+44 deg	Streetligh...	94 %	0.570	-
LH351Z	118+47 deg	Streetligh...	93 %	0.560	-
LH351B	118+46 deg	Streetligh...	93 %	0.550	-
TL1L4	116+45 deg	Streetligh...	88 %	0.570	-
RLE G1 49x223mm 4000lm xxx EXC OTD21+48 deg		Streetligh...	94 %	0.580	-
RLE G1 49x245mm 4000lm xxx EXC OTD21+48 deg		Streetligh...	94 %	0.580	-
RLE G1 49x121mm 2000lm xxx EXC OTD21+48 deg		Streetligh...	94 %	0.580	-
RLE G1 49x133mm 2000lm xxx EXC OTD21+48 deg		Streetligh...	94 %	0.580	-

H G F E D C B A

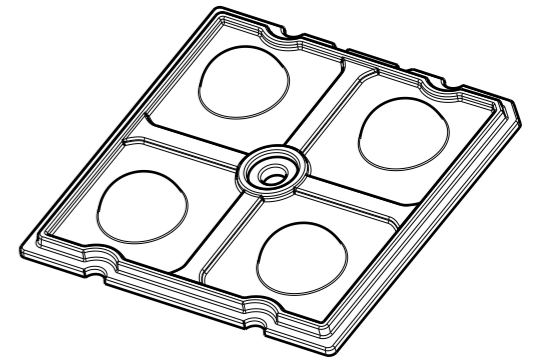
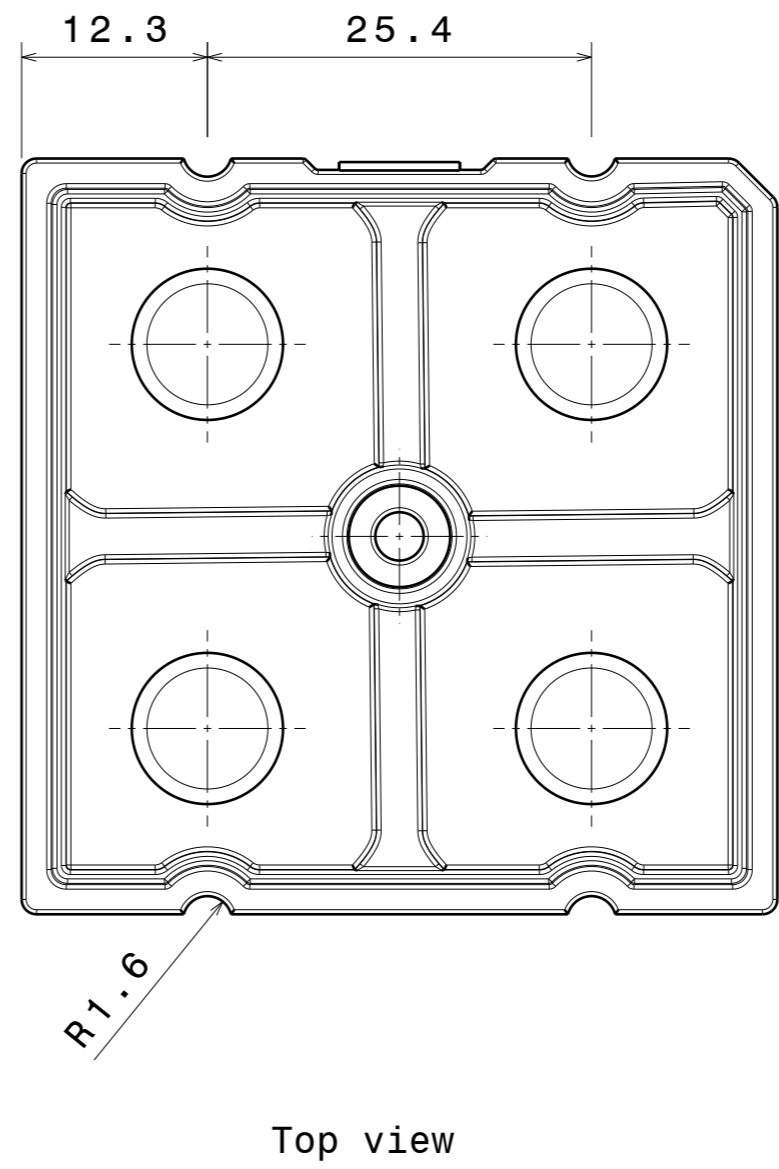
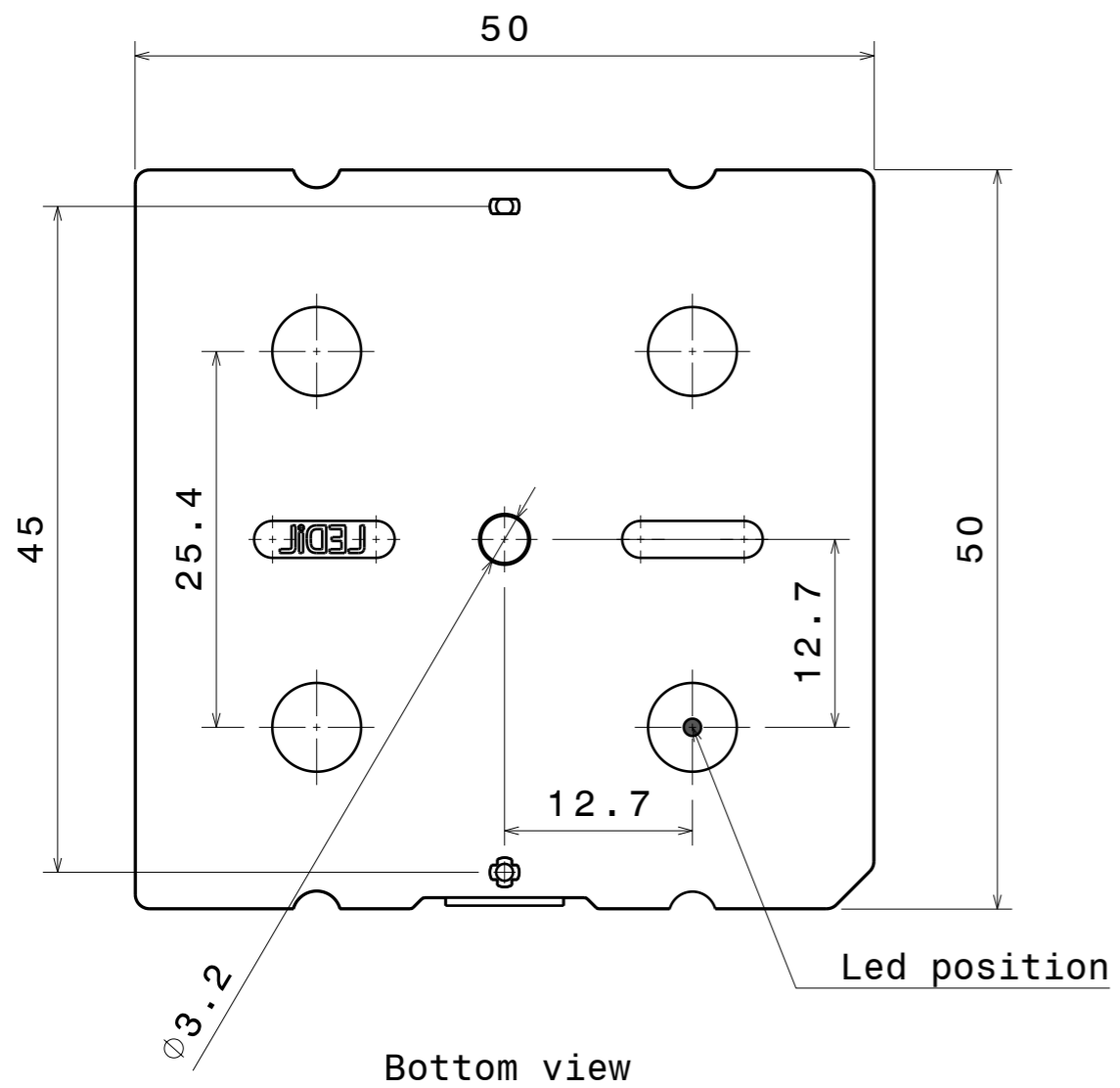

Isometric view
Scale 1:1

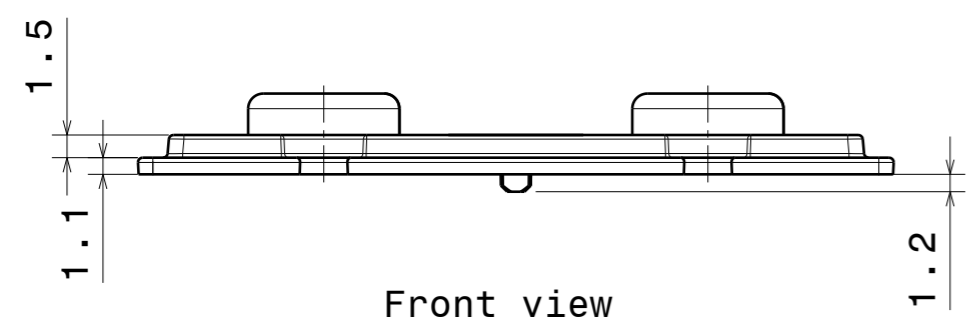
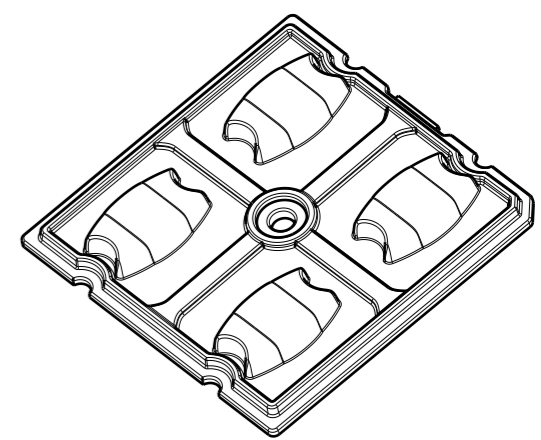

This drawing applies to:
C13936_STRADA-2X2-B2-STP
C13937_STRADA-2X2-C-STP

Tolerances if not otherwise shown According to DIN ISO 2768-1 Linear measures: Up to 30mm class M, otherwise class C. According to DIN ISO 2768-2 Form and position: class L	Ledil Oy Salorankatu 10 FIN 24240 SALO Finland	DRAWING TITLE	
		Datasheet_STRADA-2X2-STP	
THIRD ANGLE PROJECTION:	SIZE	PART NUMBER	
	A3	-	
This drawing is the property of LEDiL Oy. It may not be reproduced, copied or communicated without a written agreement with LEDiL Oy."	SCALE	2:1	WEIGHT (g)
	SHEET	1/1	

4
3
2
1

4
3
2
1

H G F E D C B A

Luminaire: LEDiL Oy C13936_STRADA-2x2-B2-STP_(XP-G2)

Lamps: 1 x Cree_XP-G2_(XPGBWT-L1-000-00-G51)_411.002lm@250mA_P=2.95164W_I=0.250A

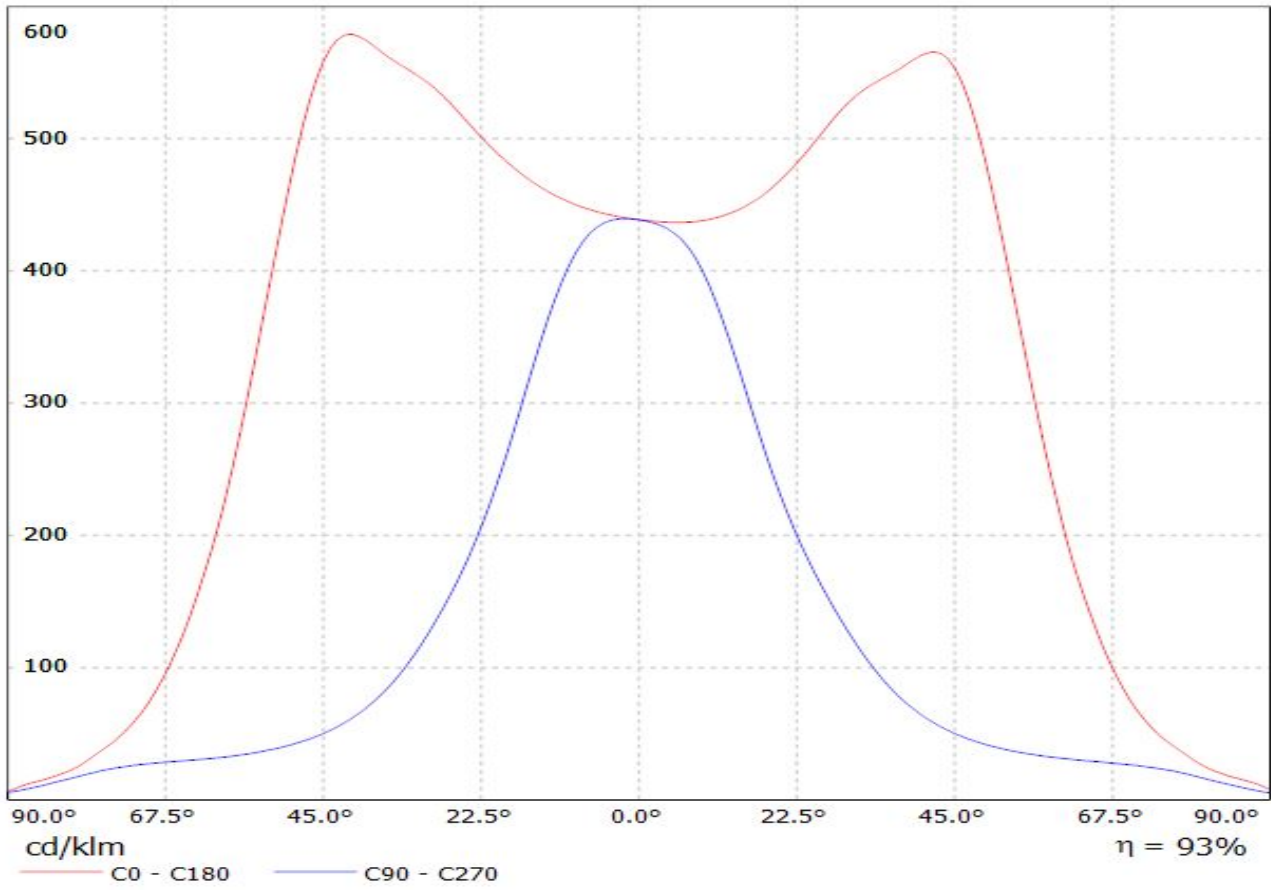

Luminaire: LEDiL Oy C13936_STRADA-2X2-B2-STP_(XP-L_HI)
Lamps: 1 x Cree_XP-L_HI_(2x2)_(XPLAWT-H-5A3-U60-013-0001)
_455.077lm@250mA_P=2.84011W_I=0,2499A

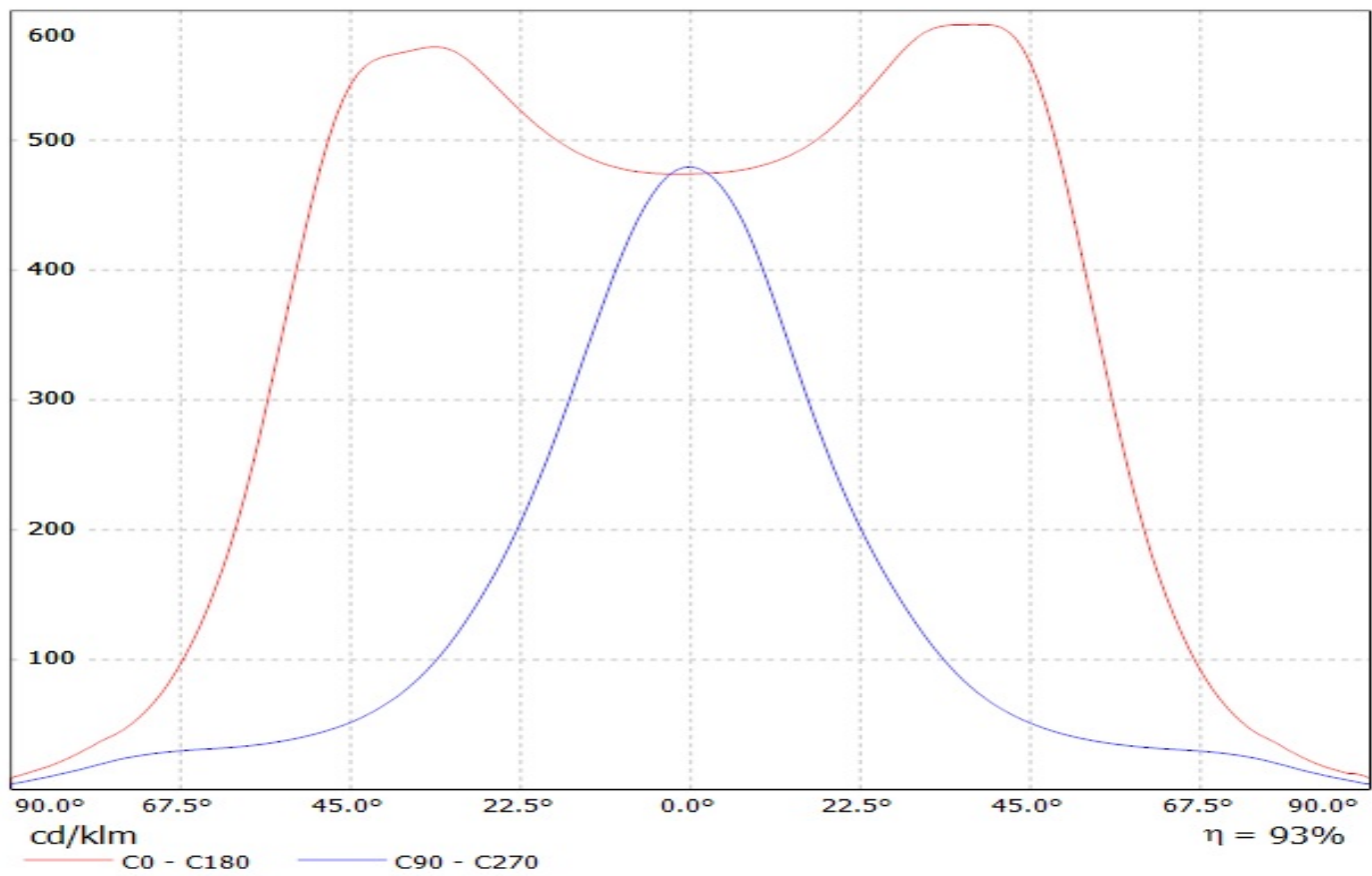

Luminaire: Ledil C13936_STRADA-2x2-B2-STP_(XP-G3)

Lamps: 1 x Cree_XP-G3_2x2_(XPGDWT-B1-3C0-S4-0-01)_516.212lm@250mA_P=2.78875W_I=0.250A

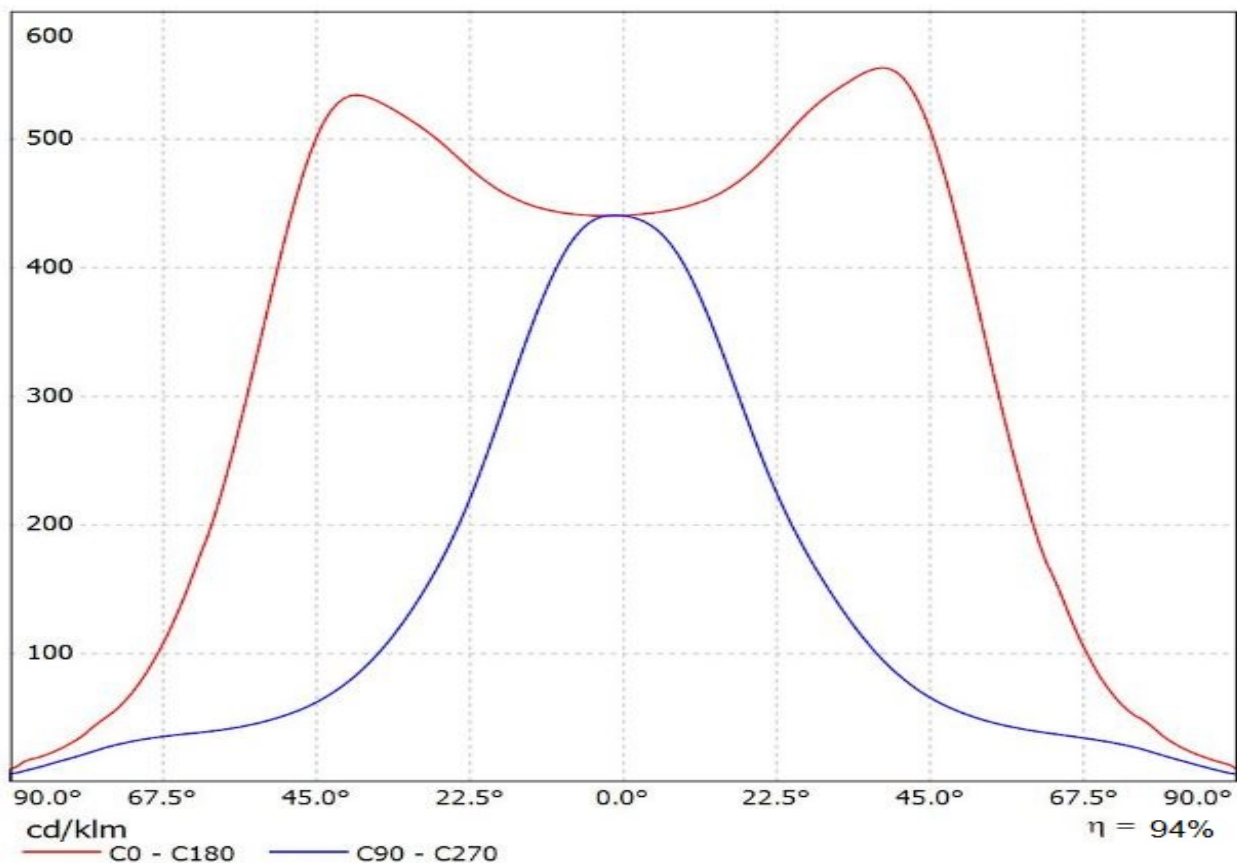

Luminaire: Ledil C13936_STRADA-2x2-B2-STP_(H35C1)
Lamps: 1 x LG_H35C1_2x2_477.216lm@250mA_P=2.87475W_I=0.250A

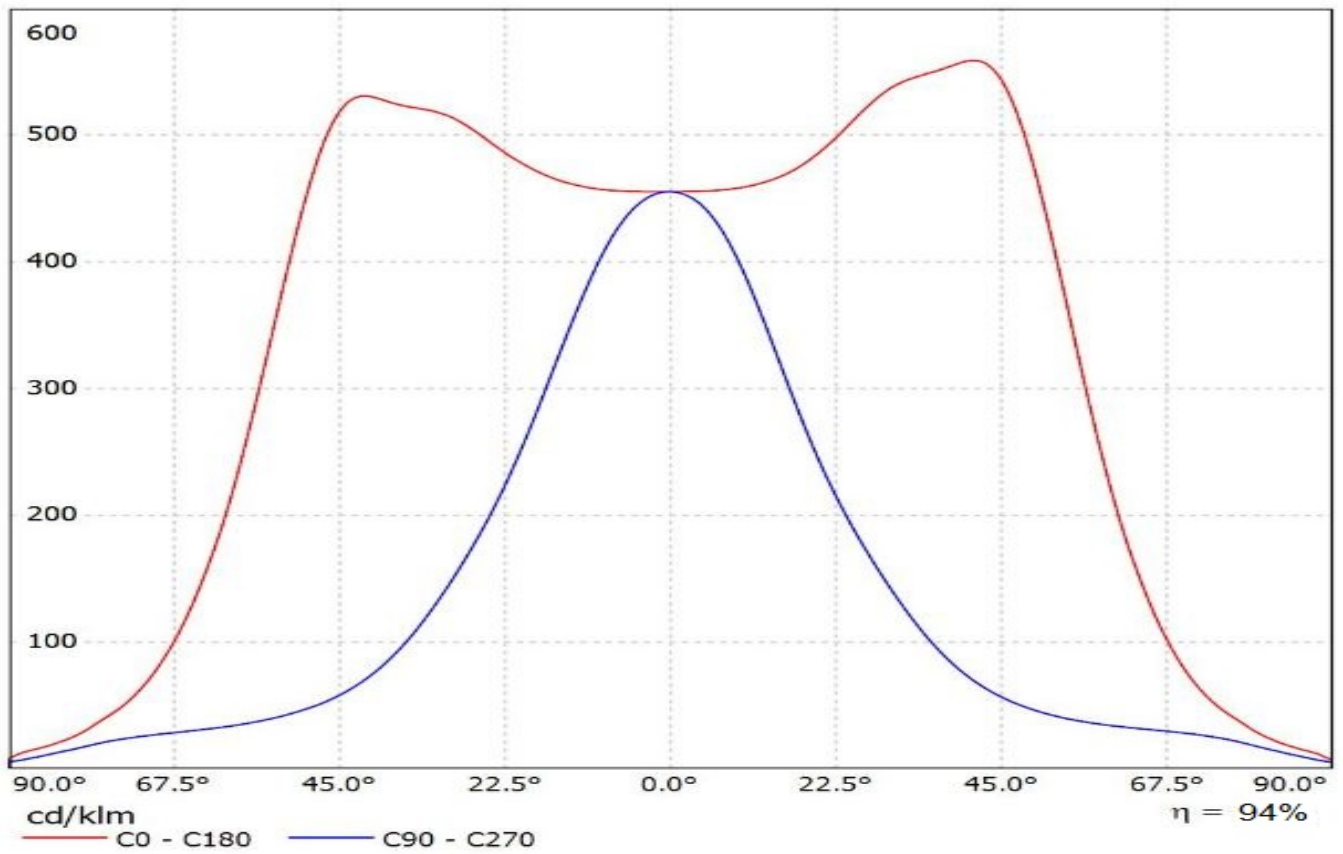

Luminaire: LEDiL Oy C13936_STRADA-2x2-B2-STP_(Luxeon_TX)
Lamps: 1 x Luxeon_TX_(L1T2-3585)_319.001lm@250mA_P=2.78902W_I=0.250A

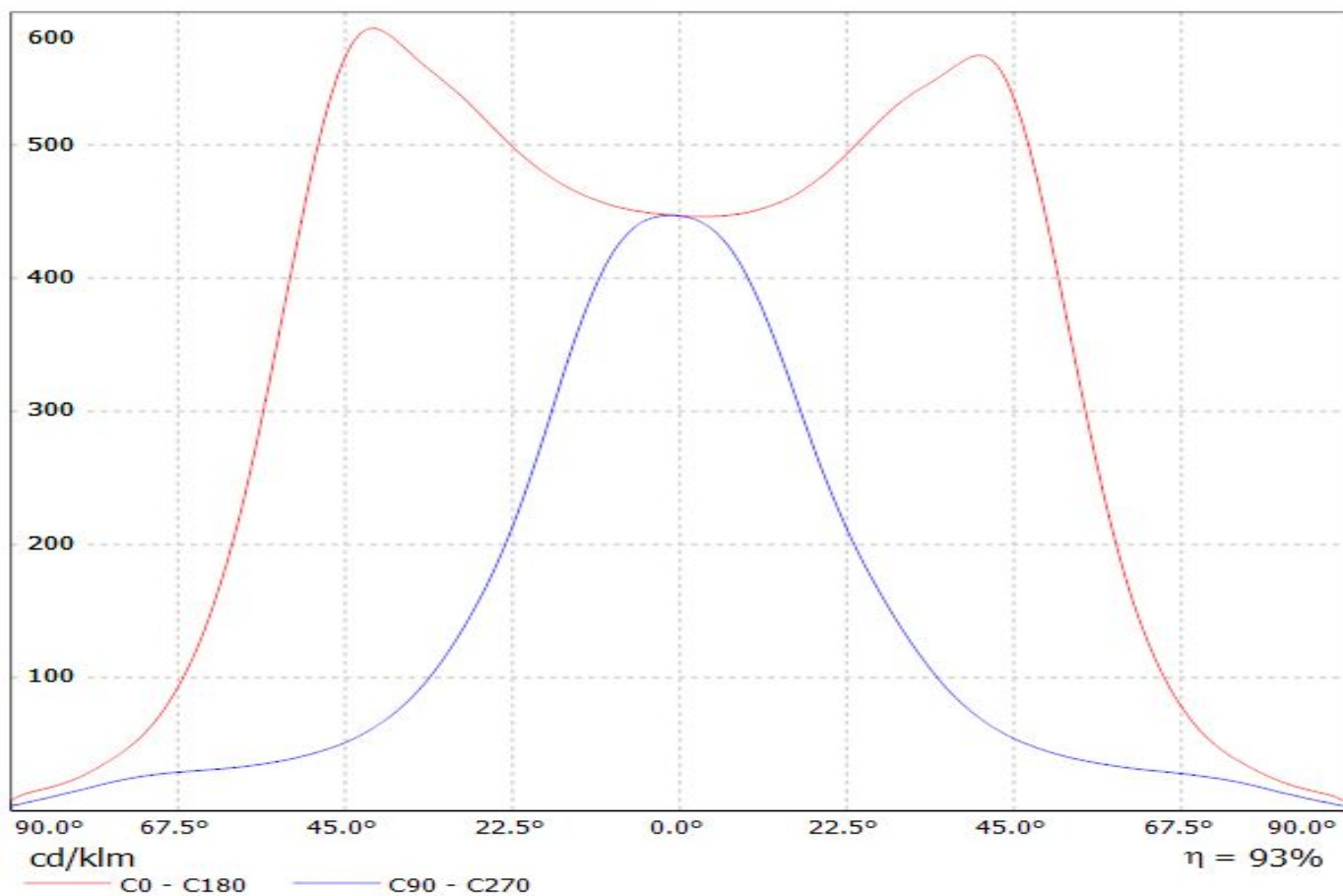

Luminaire: LEDiL Oy C13936_STRADA-2X2-B2-STP_(E21A)
Lamps: 1 x Nichia_E21A_452.248lm@250mA_2.805W_I=0.250A

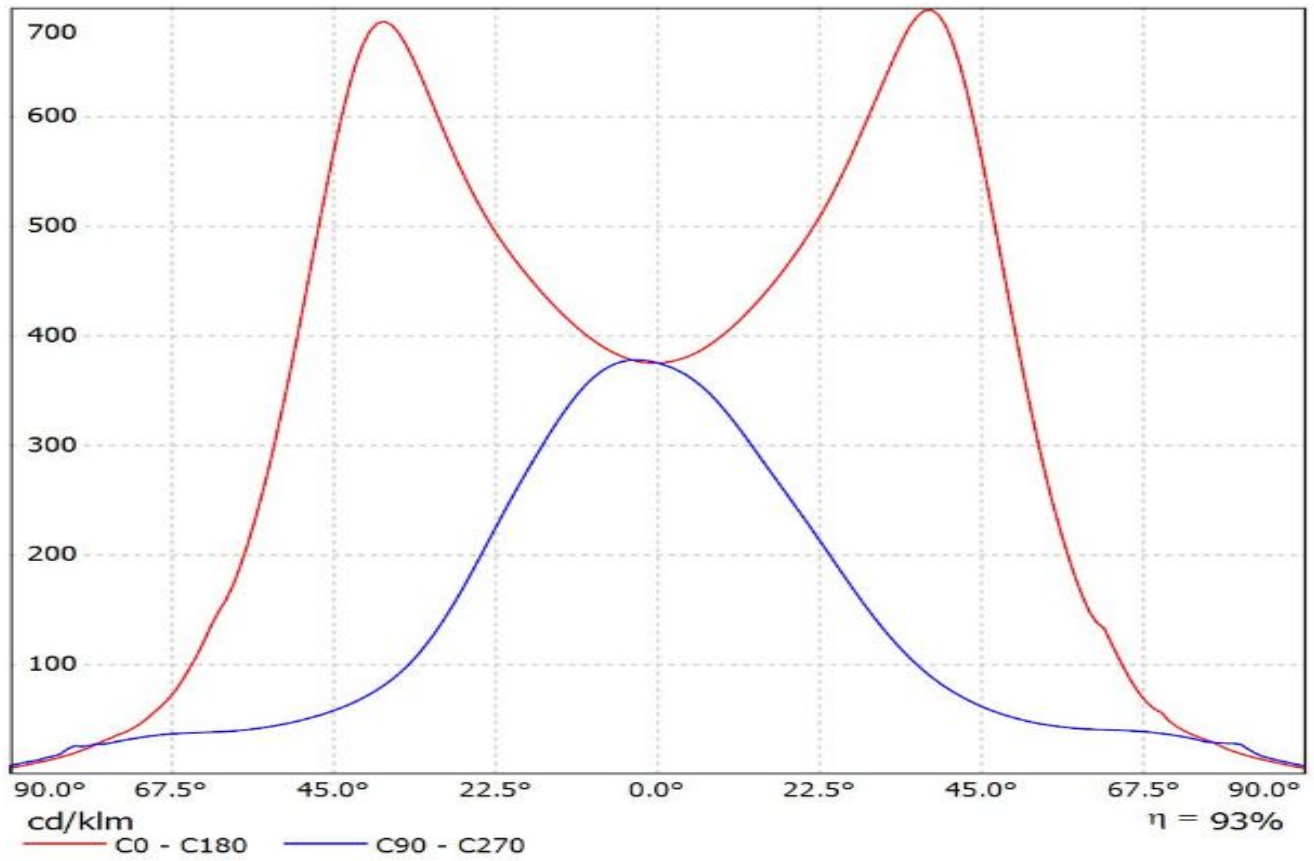

Luminaire: LEDiL Oy C13936_STRADA-2X2-B2-STP_(NVSW319AE)
Lamps: 1 x Nichia_NVSW319AE_499.093lm@250mA_P=2.79052W_I=0.25A

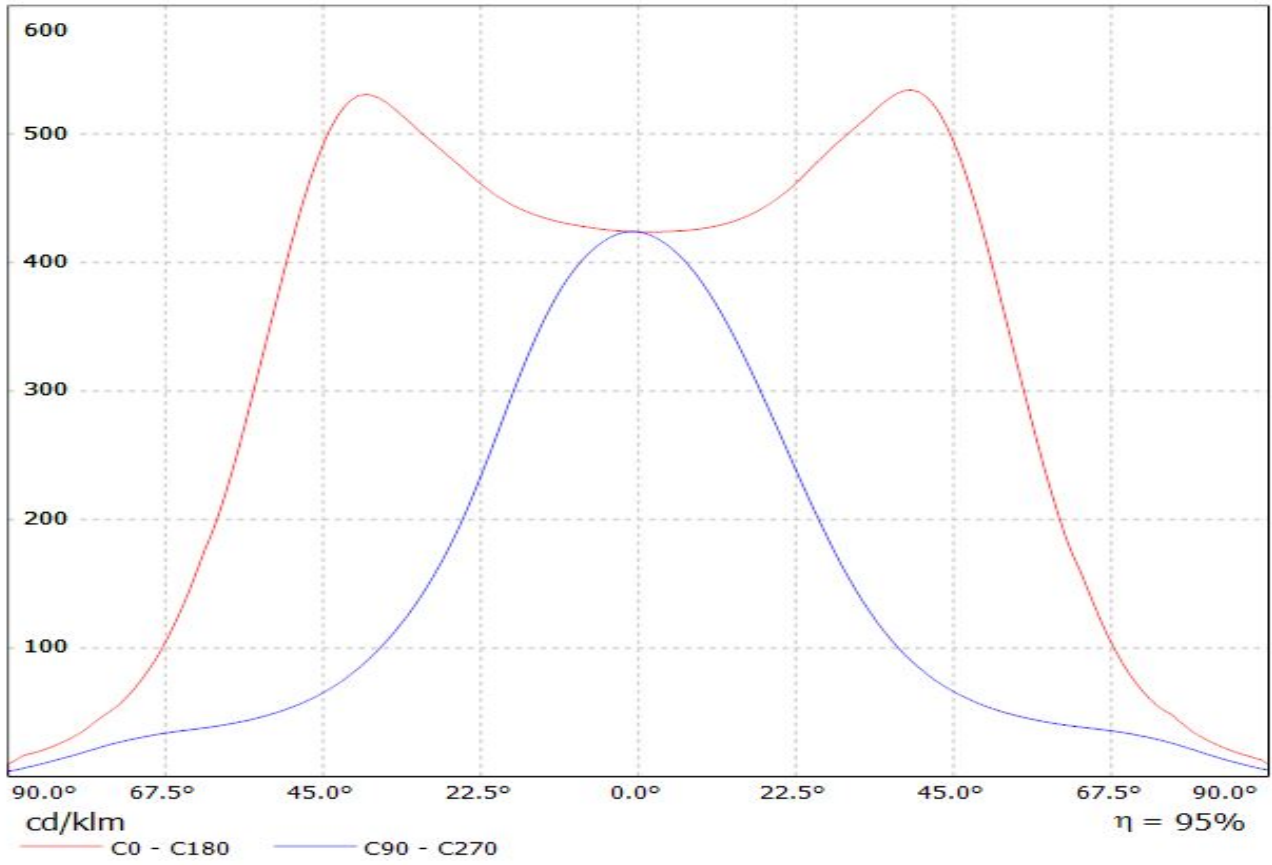

Luminaire: LEDiL Oy C13936_STRADA-2X2-B2-STP_(Oslon_Square_PC_2x2)
Lamps: 1 x Osram_Oslon_Square_PC_2x2_(GWCSSRM1.PC)
_411.322lm@250mA_P=2.85186W_I=0,2499A

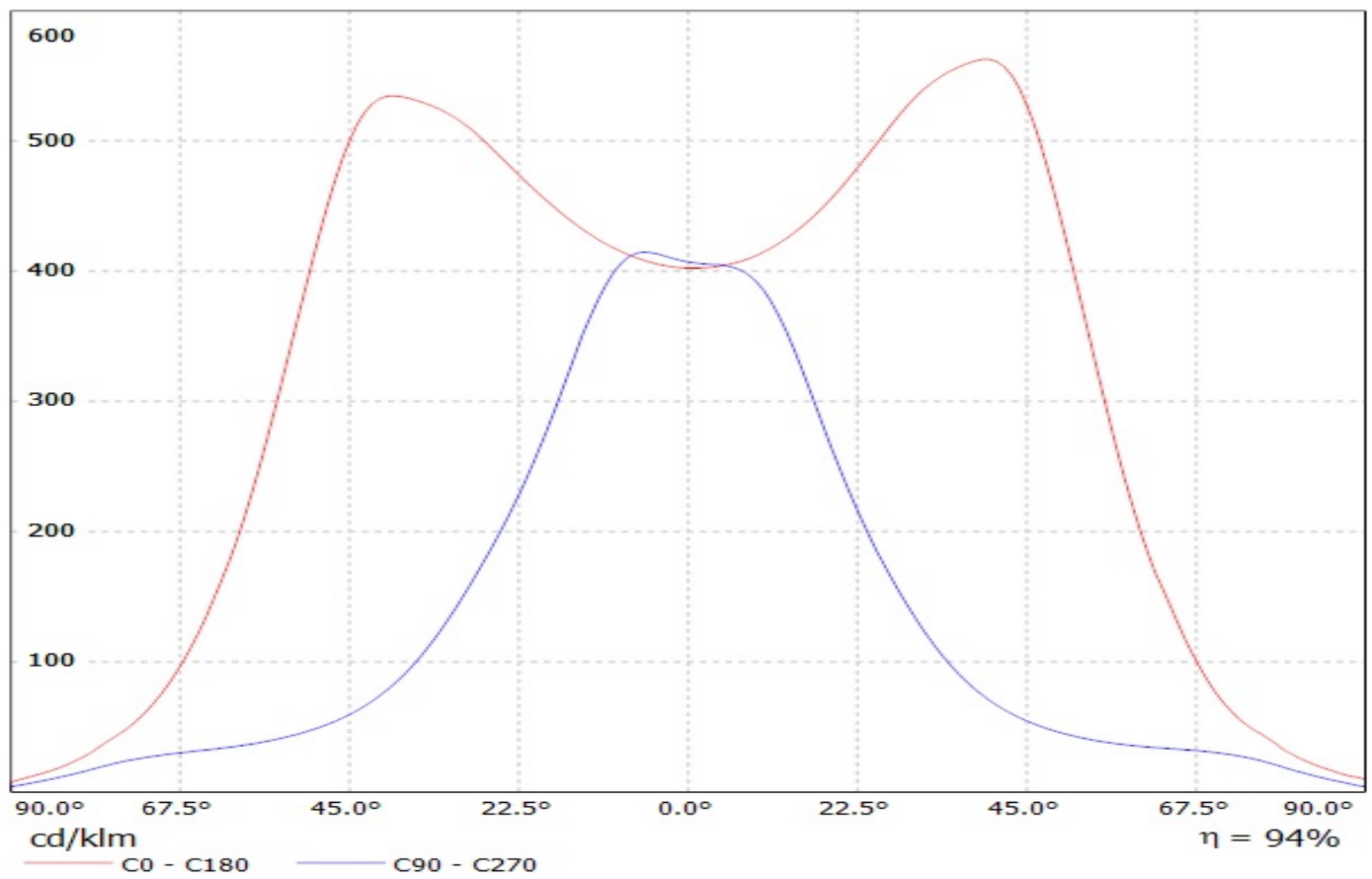

Luminaire: Ledil C13936_STRADA-2x2-B2-STP_(Square_Gen3)
Lamps: 1 x Osram_Square_Gen3_(GW_CSSRM2.PM)_461.082lm@250mA_P=2.79075W_I=0.250A

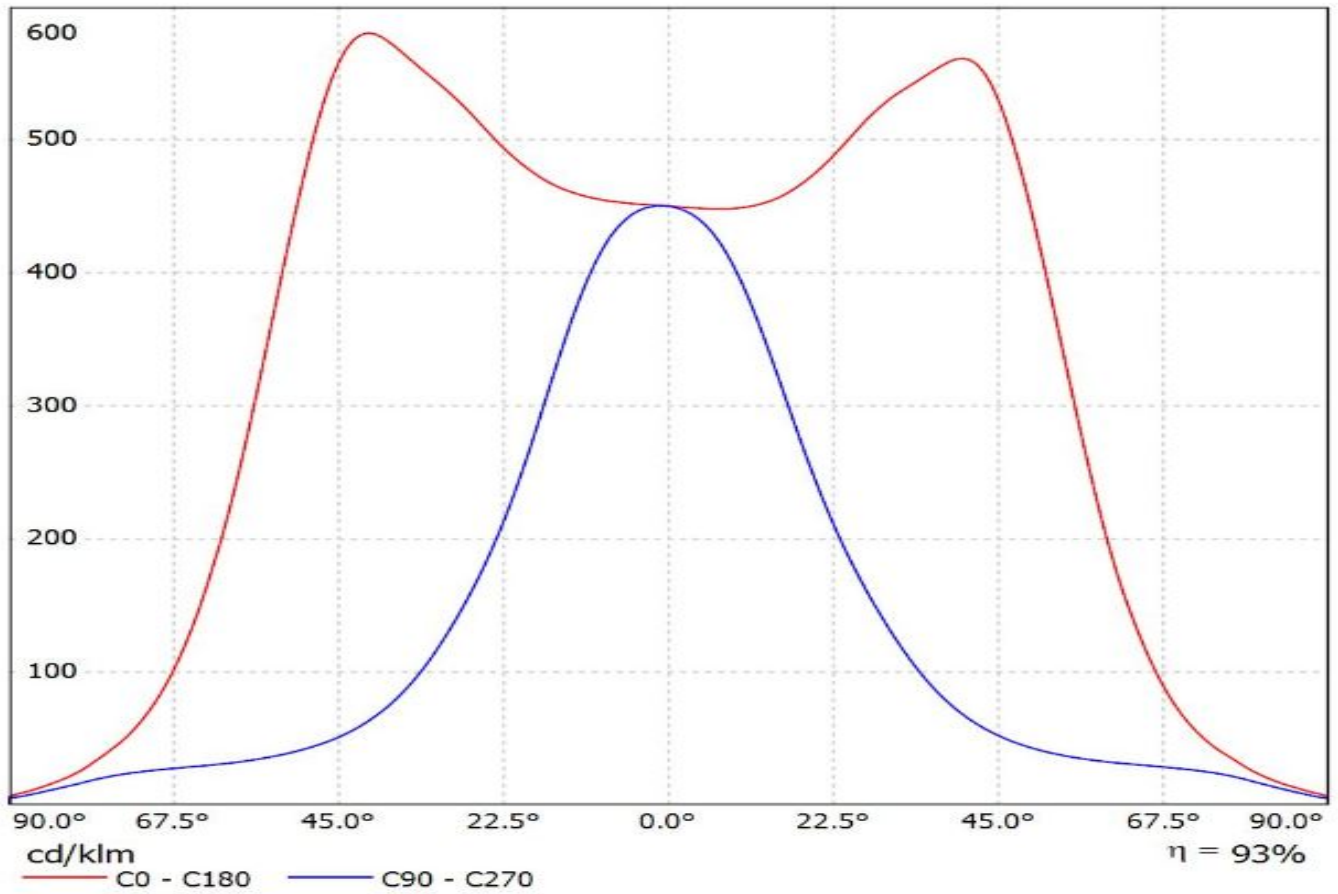

Luminaire: LEDiL Oy C13936_STRADA-2X2-B2-STP_(Fortimo_F-Flex_2x8_740DAG3)
Lamps: 1 x Philips_Fortimo_F-Flex_2x8_740DAG3_1786.86lm@250mA_P=11.6092W_I=0.2498A

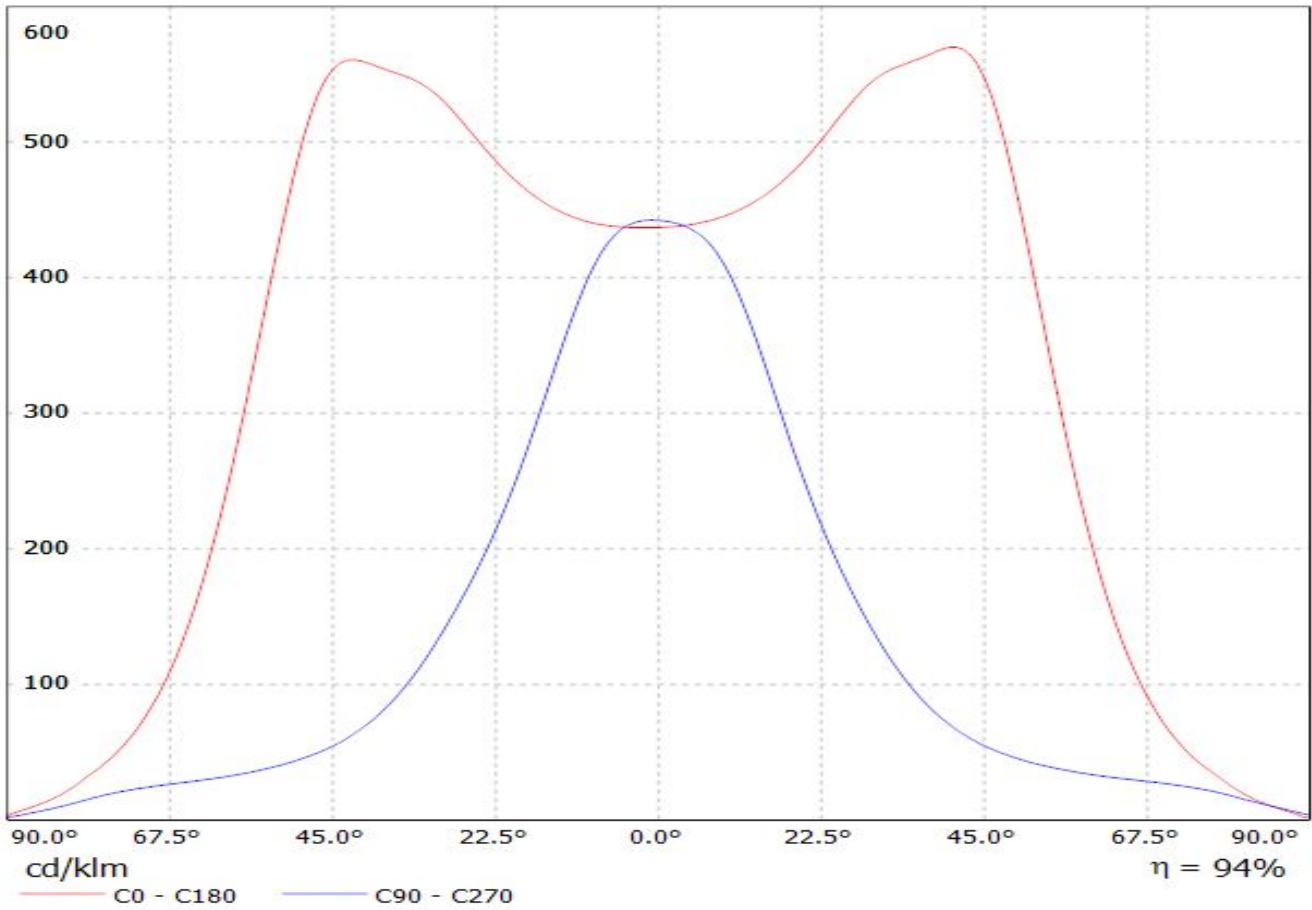

Luminaire: LEDiL Oy C13936_STRADA-2X2-B2-STP_(LH351Z) Eff.93.1%
Lamps: 1 x SAMSUNG_LH351Z_2x2_359.49lm@250mA_P=2.86371W_I=249.8mA

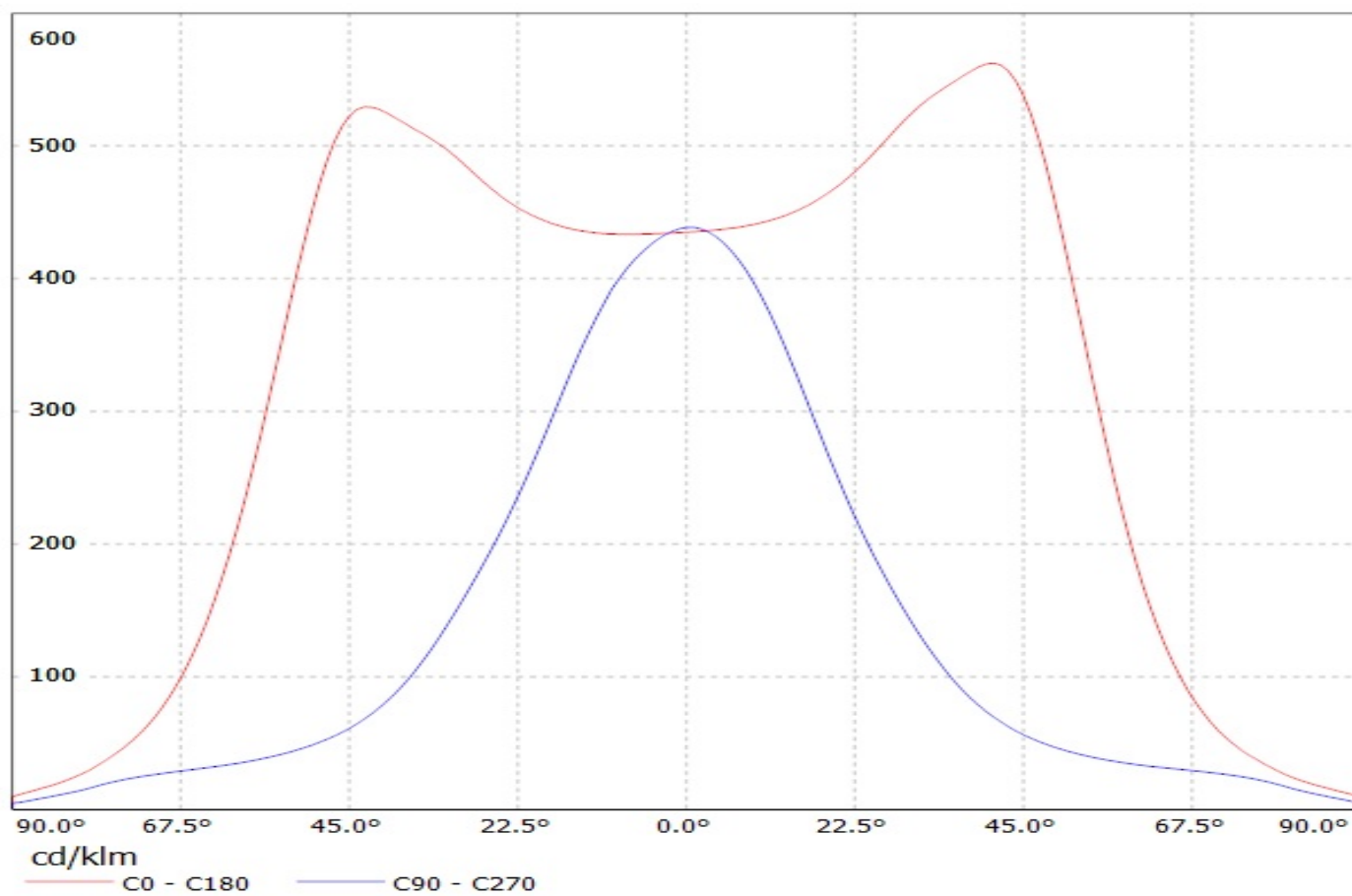

Luminaire: Ledil C13936_STRADA-2X2-B2-STP_(LH351B)

Lamps: 1 x Samsung_LH351B_2x2_444.178lm@250mA_P=2.8535W_I=0.25A

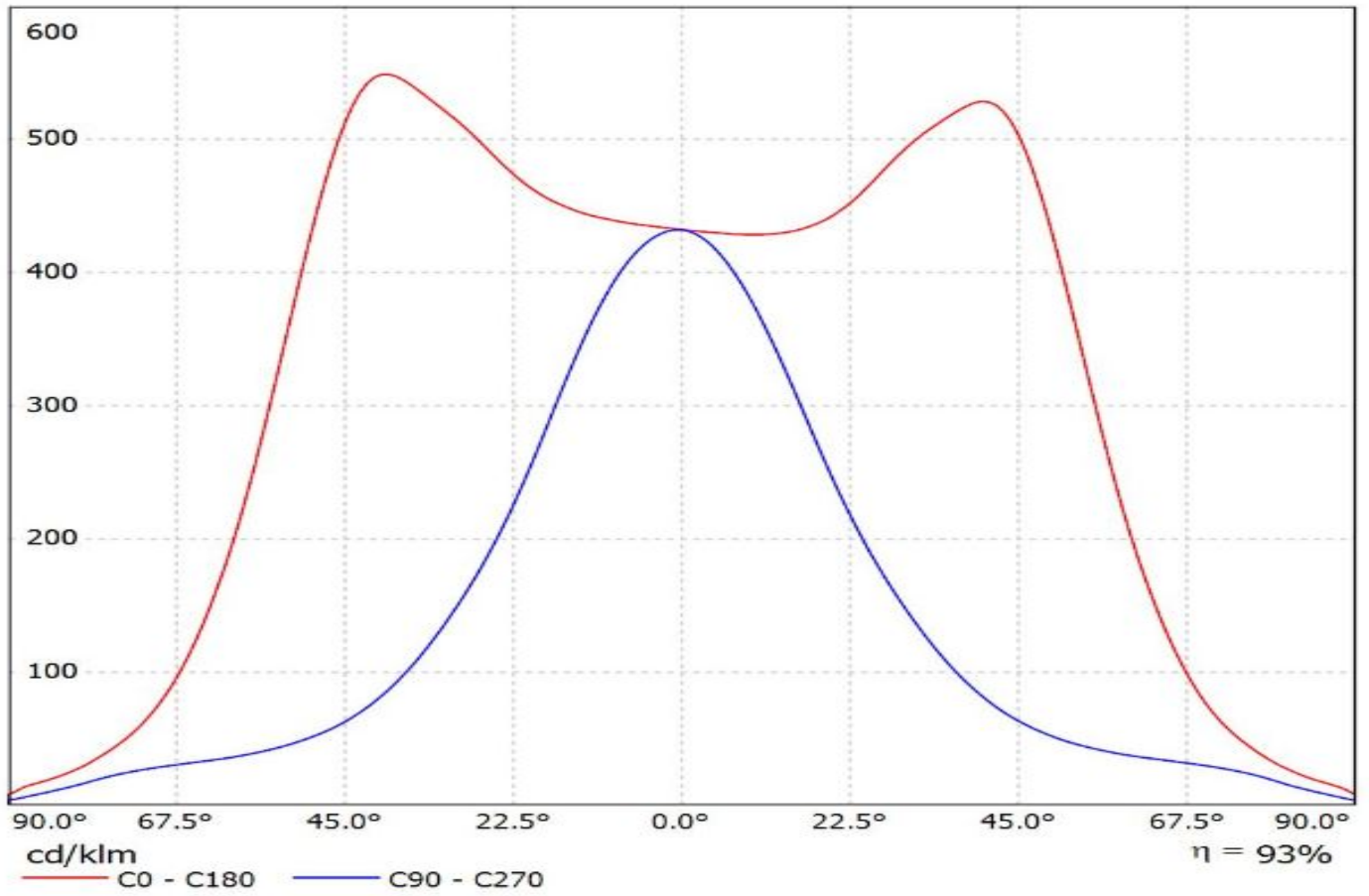

Ledil C13936_STRADA-2X2-B2-STP_(TL1L4) / LDC (Linear)

Luminaire: Ledil C13936_STRADA-2X2-B2-STP_(TL1L4)

Lamps: 1 x Toshiba_TL1L4_2x2_(TL1L4-DW0)_472.639lm@250mA_CCT=6500K_P=2.9W_I=0.25A

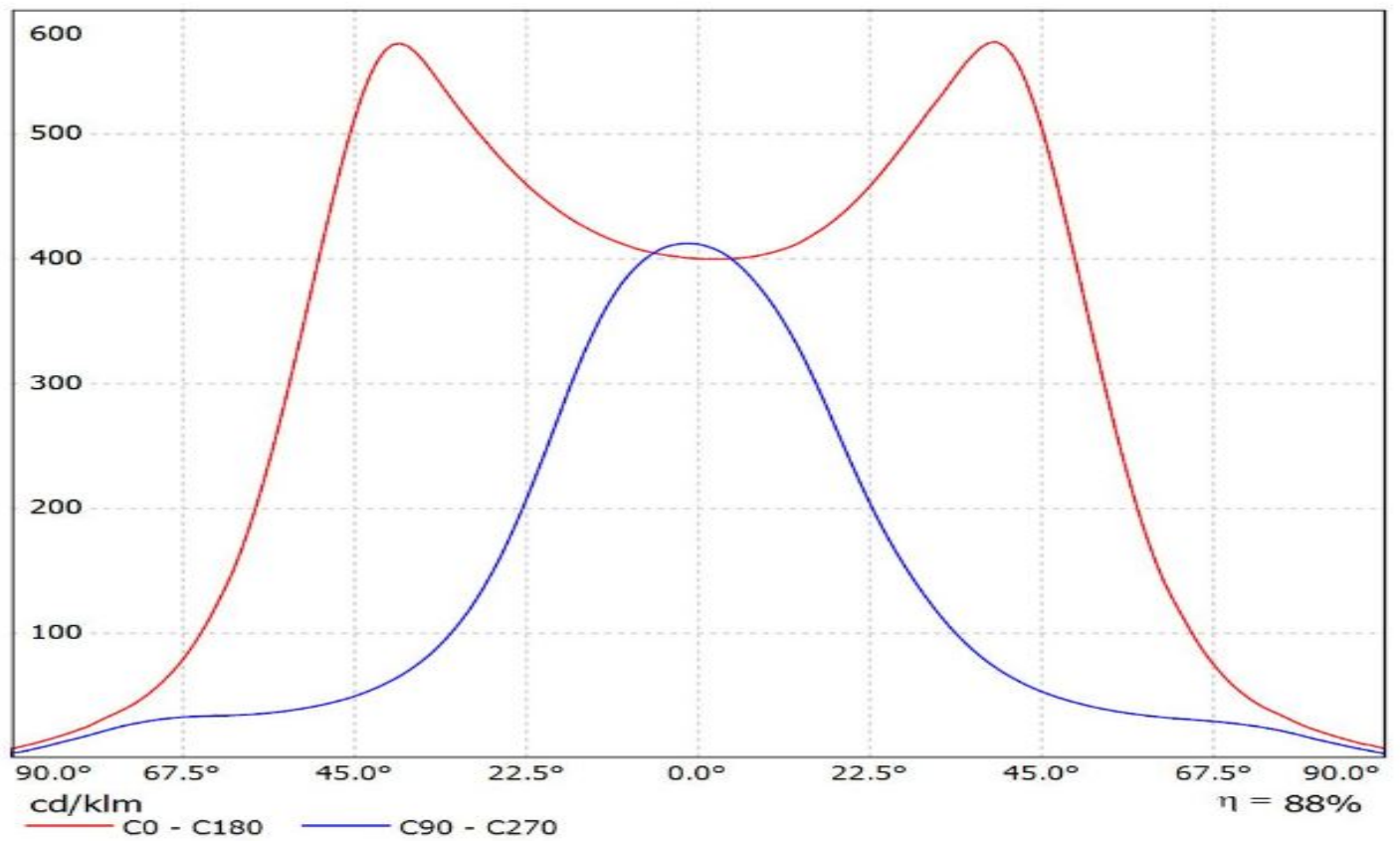

Luminaire: LEDiL Oy C13936_STRADA-2X2-B2-STP_(Tridonic_Module_RLE_G1)
Lamps: 1 x Tridonic_Module_RLE_G1_4576.03lm@700mA_P=32.0681W_I=0.700A

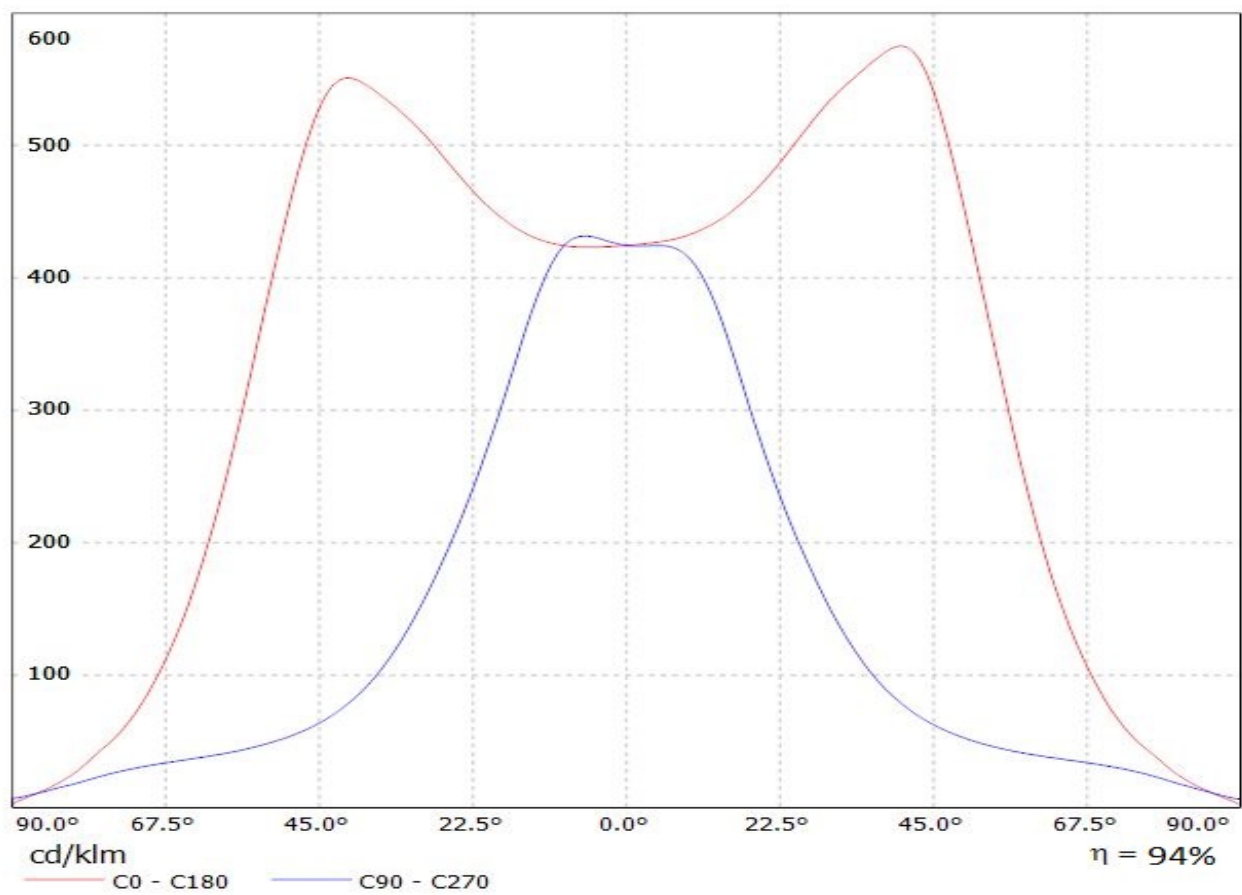

Luminaire: LEDiL Oy C13936_STRADA-2X2-B2-STP_(Tridonic_Module_RLE_G1)
Lamps: 1 x Tridonic_Module_RLE_G1_4576.03lm@700mA_P=32.0681W_I=0.700A

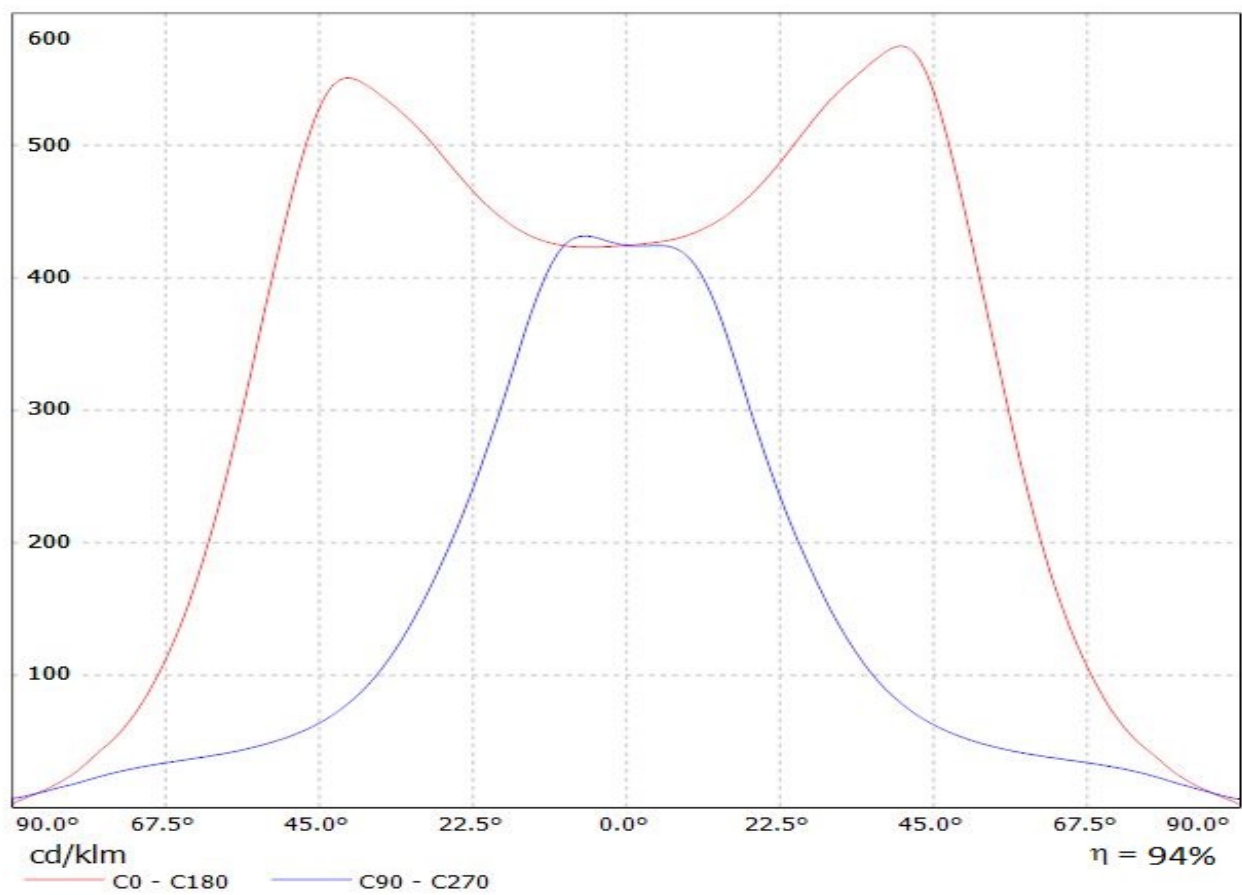

Luminaire: LEDiL Oy C13936_STRADA-2X2-B2-STP_(Tridonic_Module_RLE_G1)
Lamps: 1 x Tridonic_Module_RLE_G1_2288lm@700mA_P=16W_I=0.700A

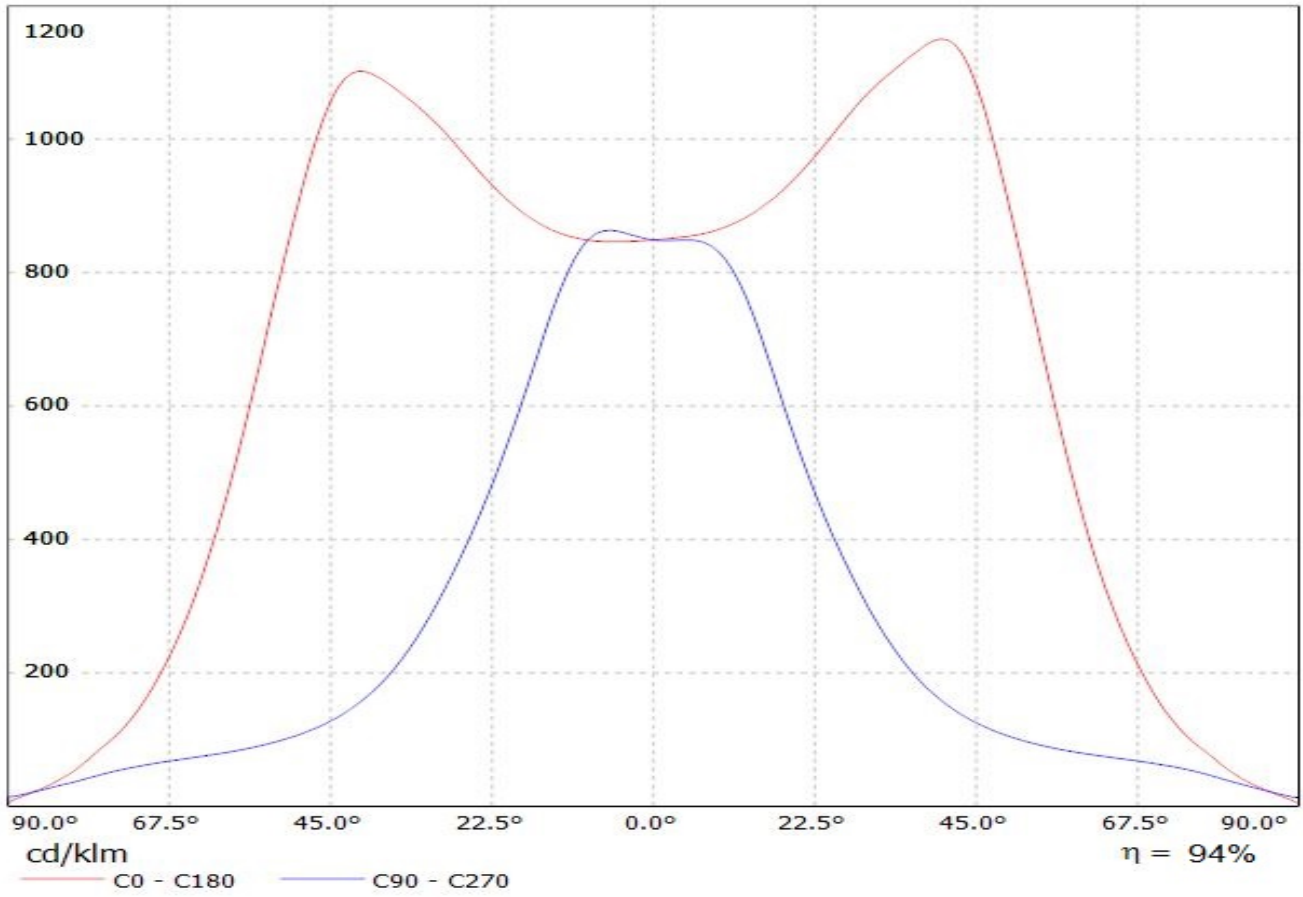

Luminaire: LEDiL Oy C13936_STRADA-2X2-B2-STP_(Tridonic_Module_RLE_G1)
Lamps: 1 x Tridonic_Module_RLE_G1_2288lm@700mA_P=16W_I=0.700A

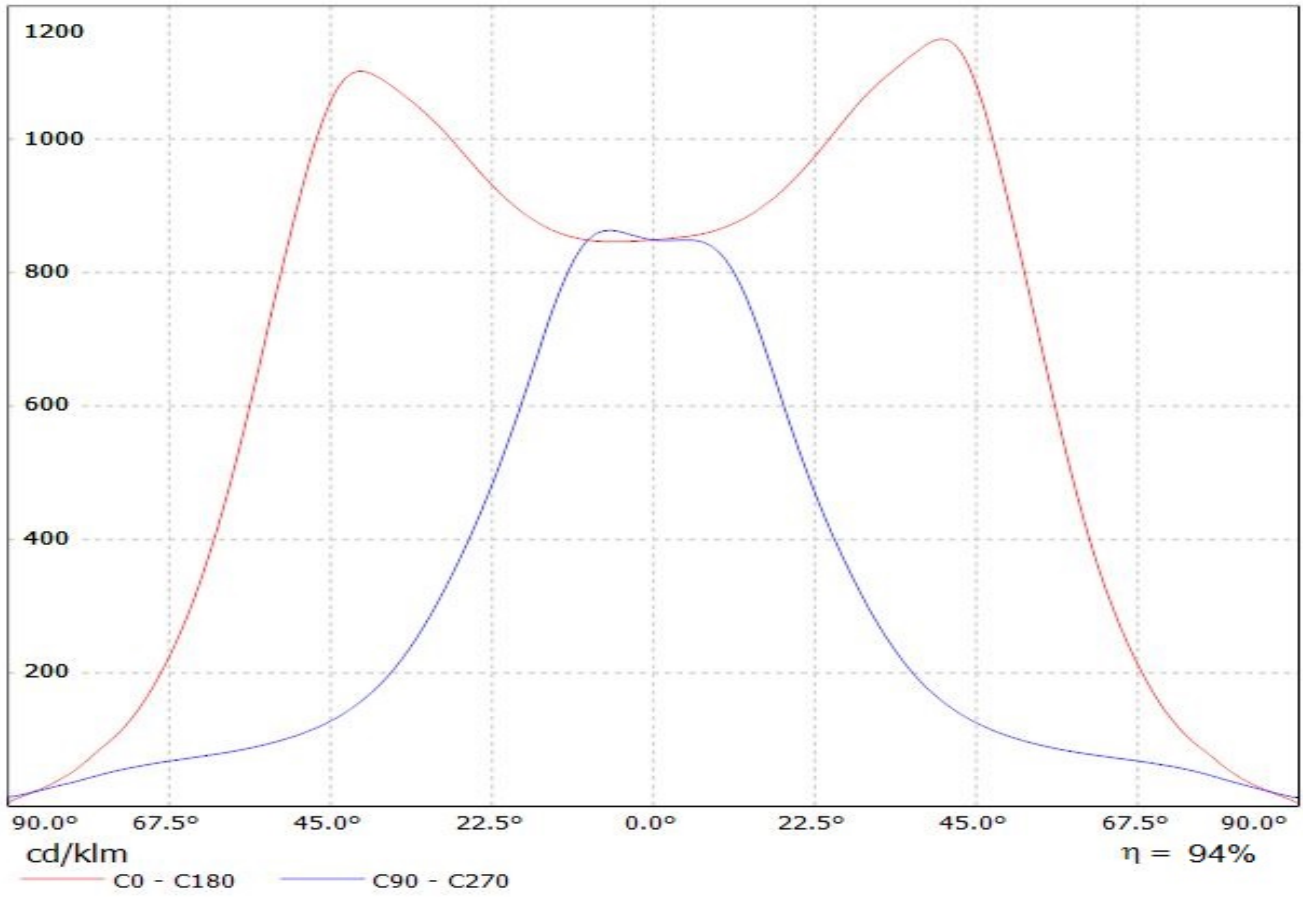

Luminaire: LEDiL Oy C13936_STRADA-2x2-B2-STP_(XP-G2)

Lamps: 1 x Cree_XP-G2_(XPGBWT-L1-000-00-G51)_411.002lm@250mA_P=2.95164W_I=0.250A

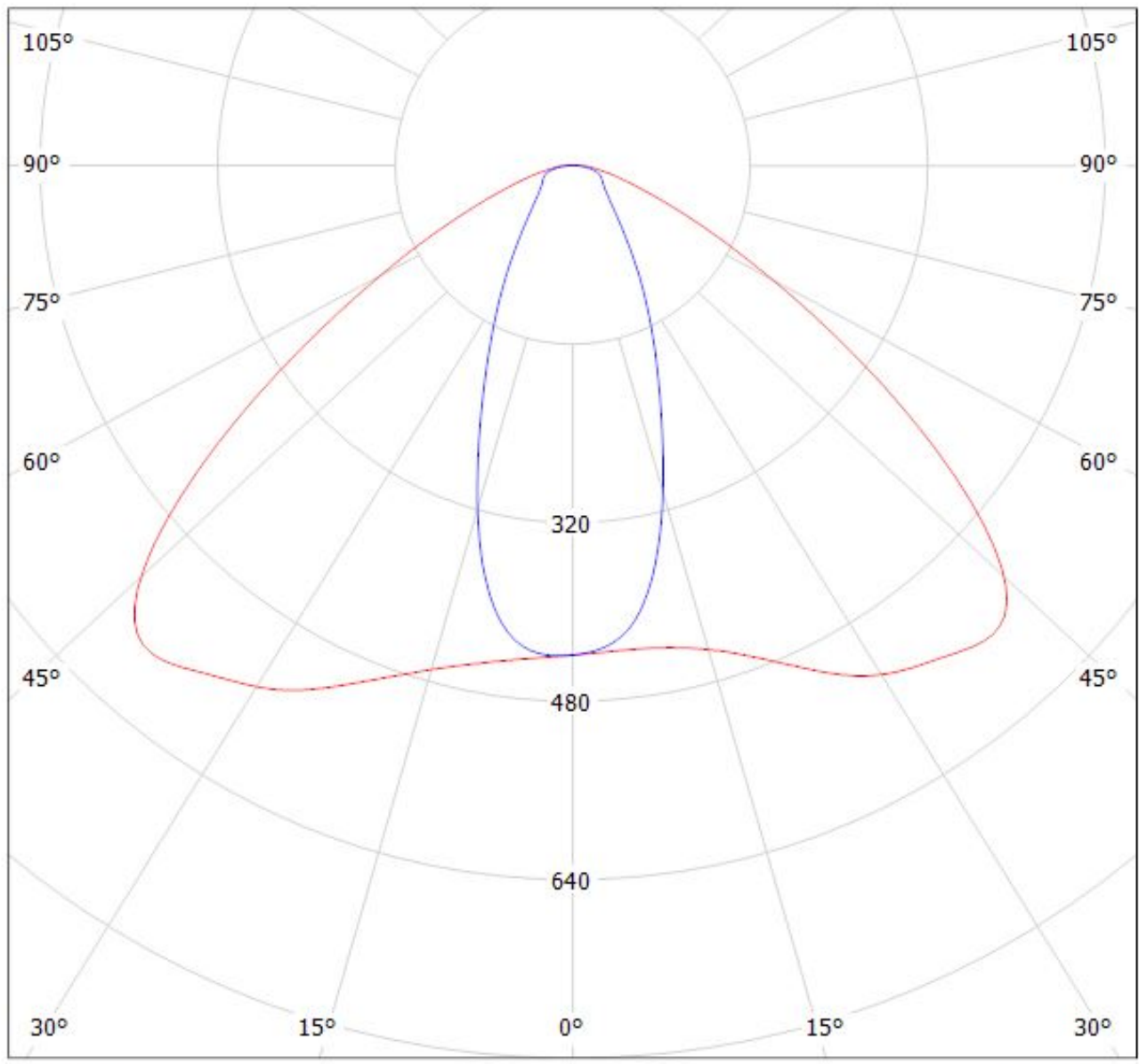

cd/klm

— C0 - C180

— C90 - C270

$\eta = 93\%$

Luminaire: LEDiL Oy C13936_STRADA-2X2-B2-STP_(XP-L_HI)
Lamps: 1 x Cree_XP-L_HI_(2x2)_(XPLAWT-H-5A3-U60-013-0001)
_455.077lm@250mA_P=2.84011W_I=0,2499A

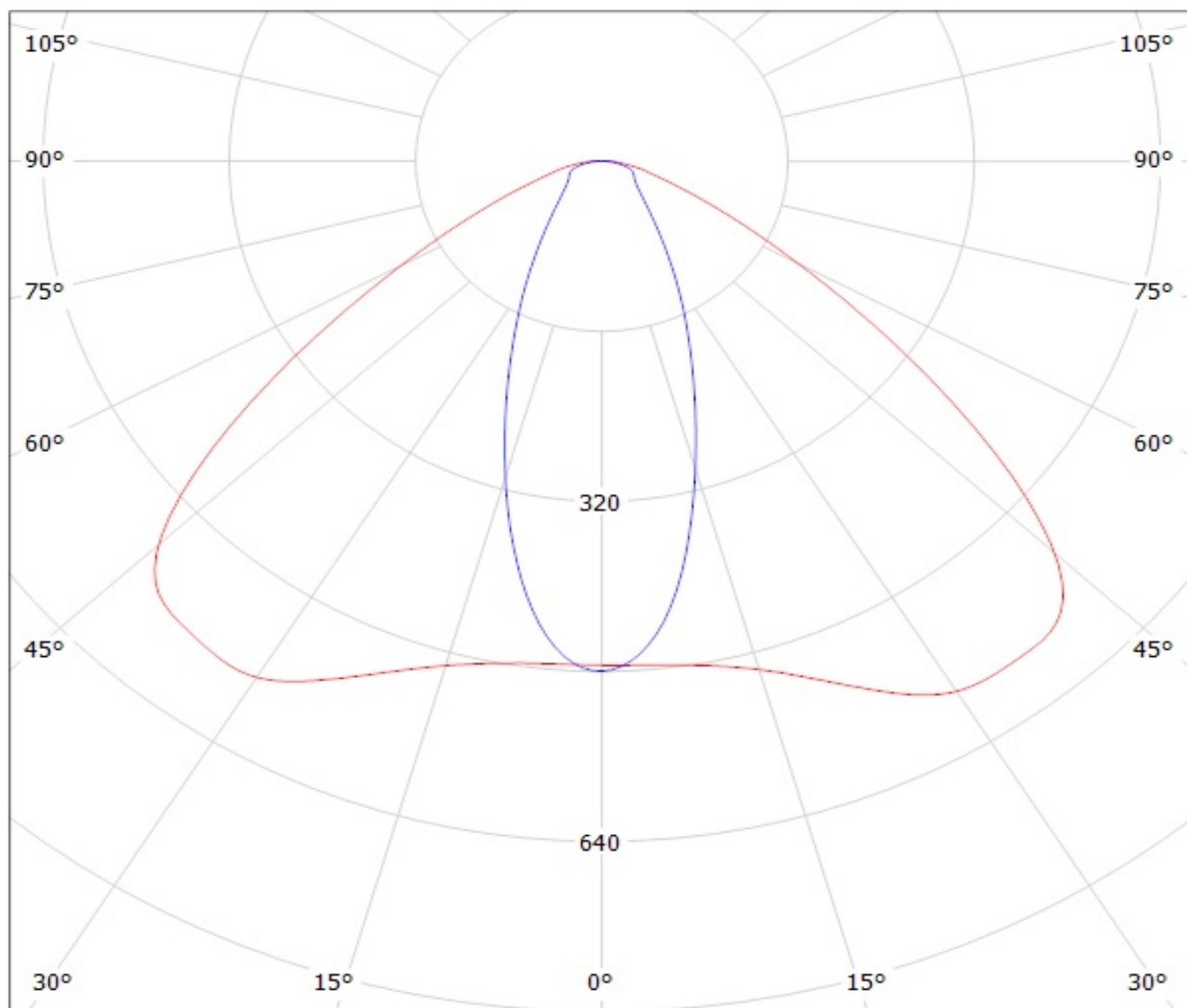

cd/klm

— C0 - C180 — C90 - C270

$\eta = 93\%$

Luminaire: Ledil C13936_STRADA-2x2-B2-STP_(XP-G3)

Lamps: 1 x Cree_XP-G3_2x2_(XPGDWT-B1-3C0-S4-0-01)_516.212lm@250mA_P=2.78875W_I=0.250A

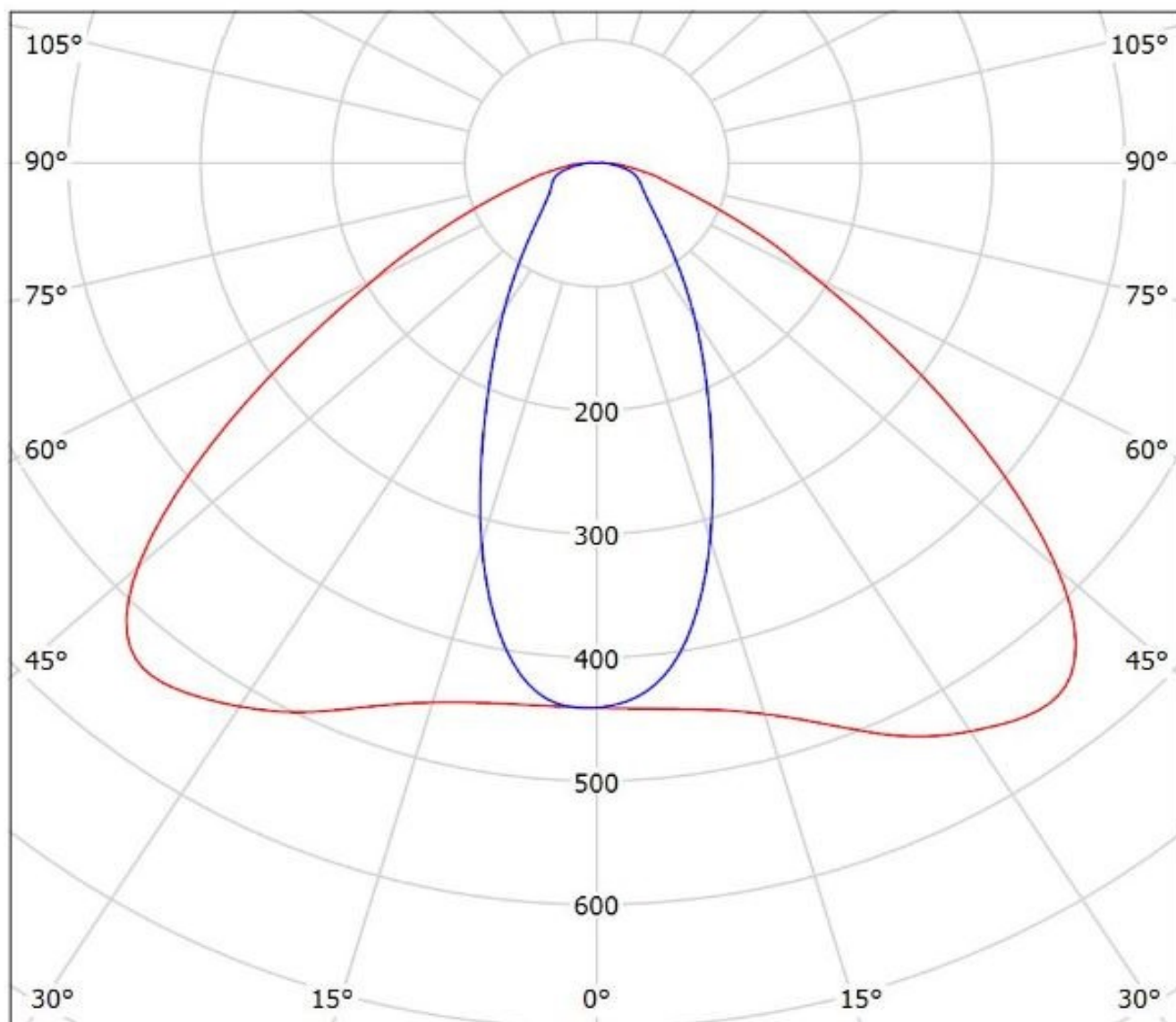

cd/klm

— C0 - C180 — C90 - C270

$\eta = 94\%$

Luminaire: Ledil C13936_STRADA-2x2-B2-STP_(H35C1)

Lamps: 1 x LG_H35C1_2x2_477.216lm@250mA_P=2.87475W_I=0.250A

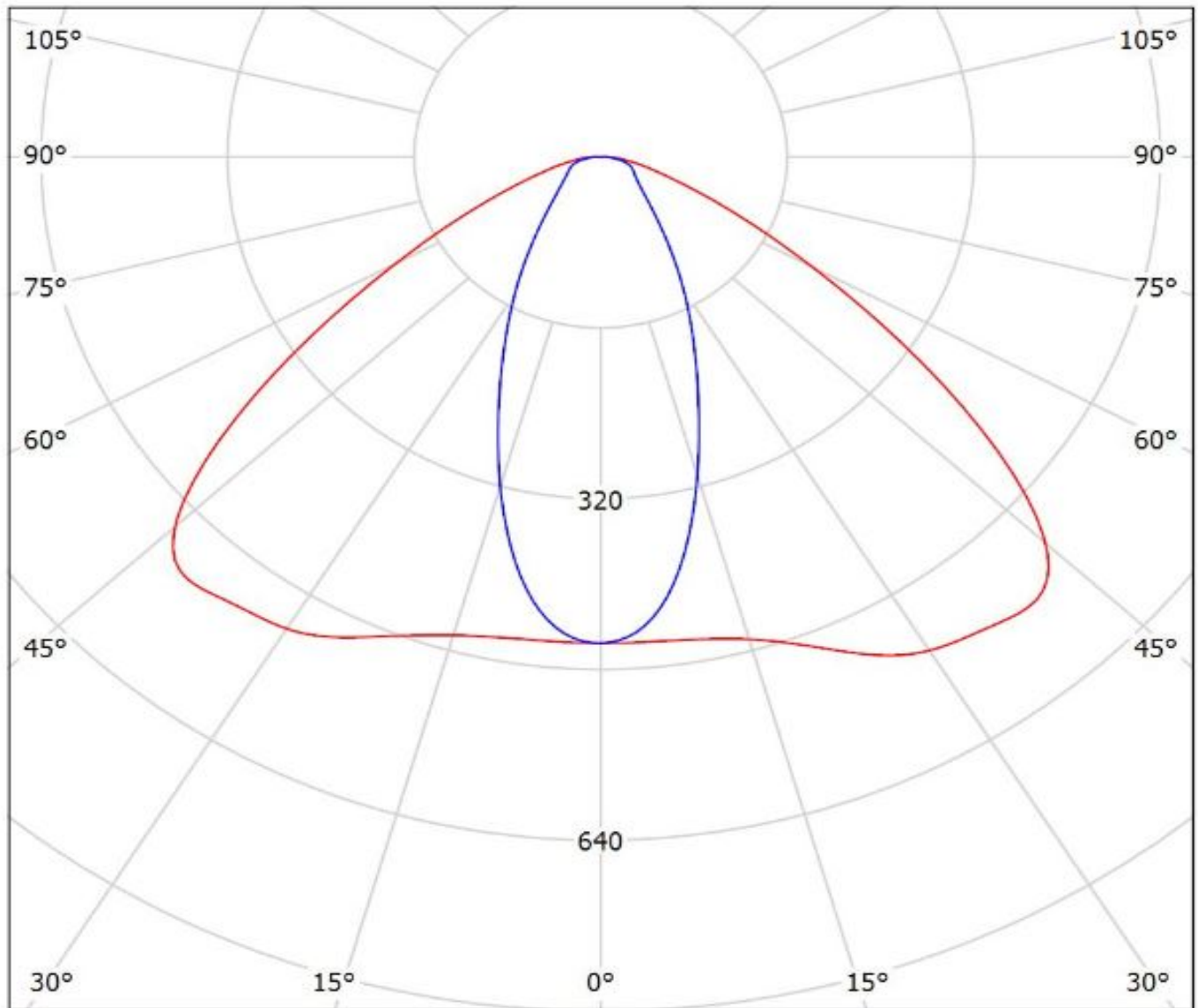

cd/klm

— C0 - C180 — C90 - C270

$\eta = 94\%$

Luminaire: LEDiL Oy C13936_STRADA-2x2-B2-STP_(Luxeon_TX)
Lamps: 1 x Luxeon_TX_(L1T2-3585)_319.001lm@250mA_P=2.78902W_I=0.250A

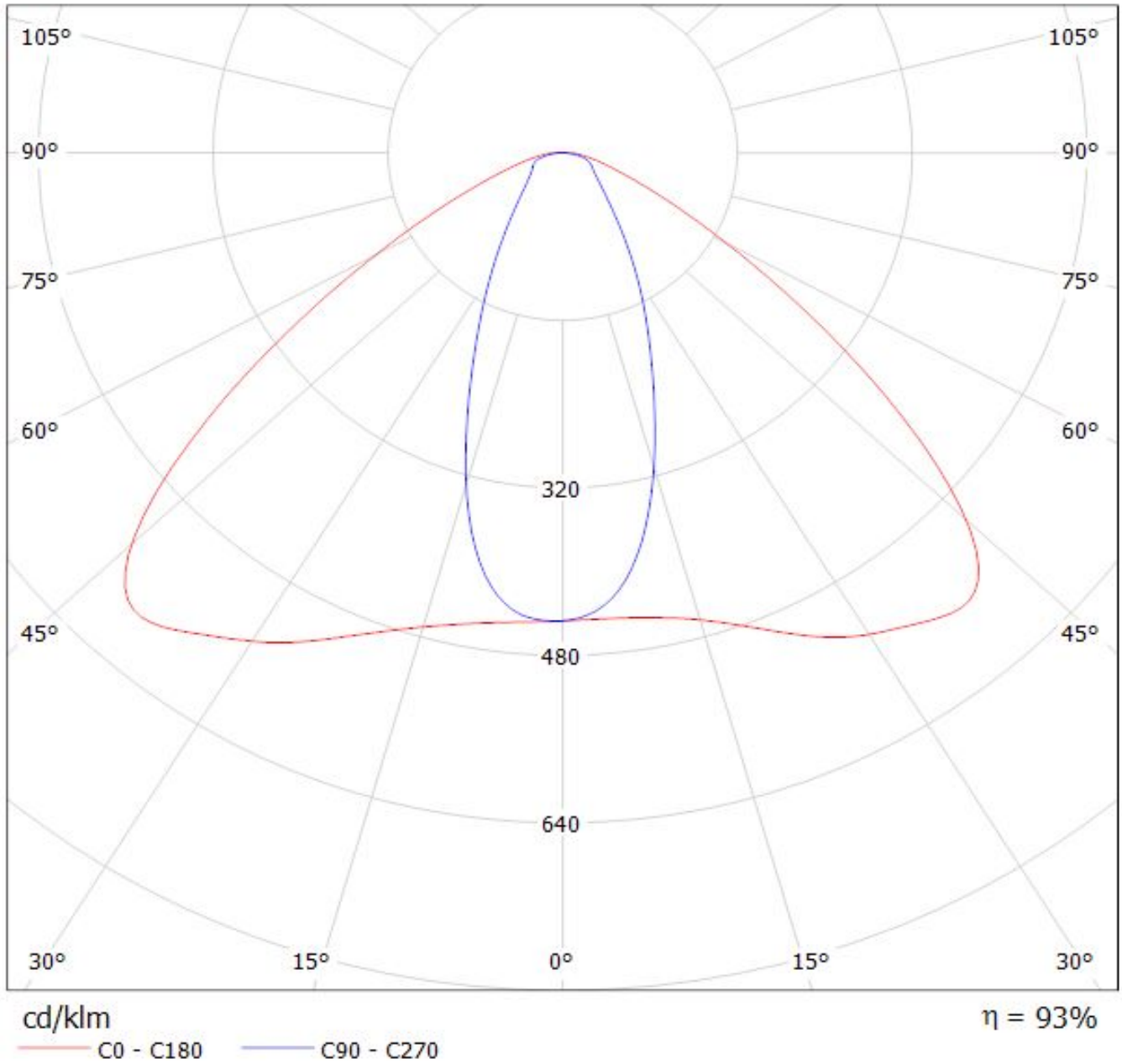

Luminaire: LEDiL Oy C13936_STRADA-2X2-B2-STP_(E21A)
Lamps: 1 x Nichia_E21A_452.248lm@250mA_2.805W_I=0.250A

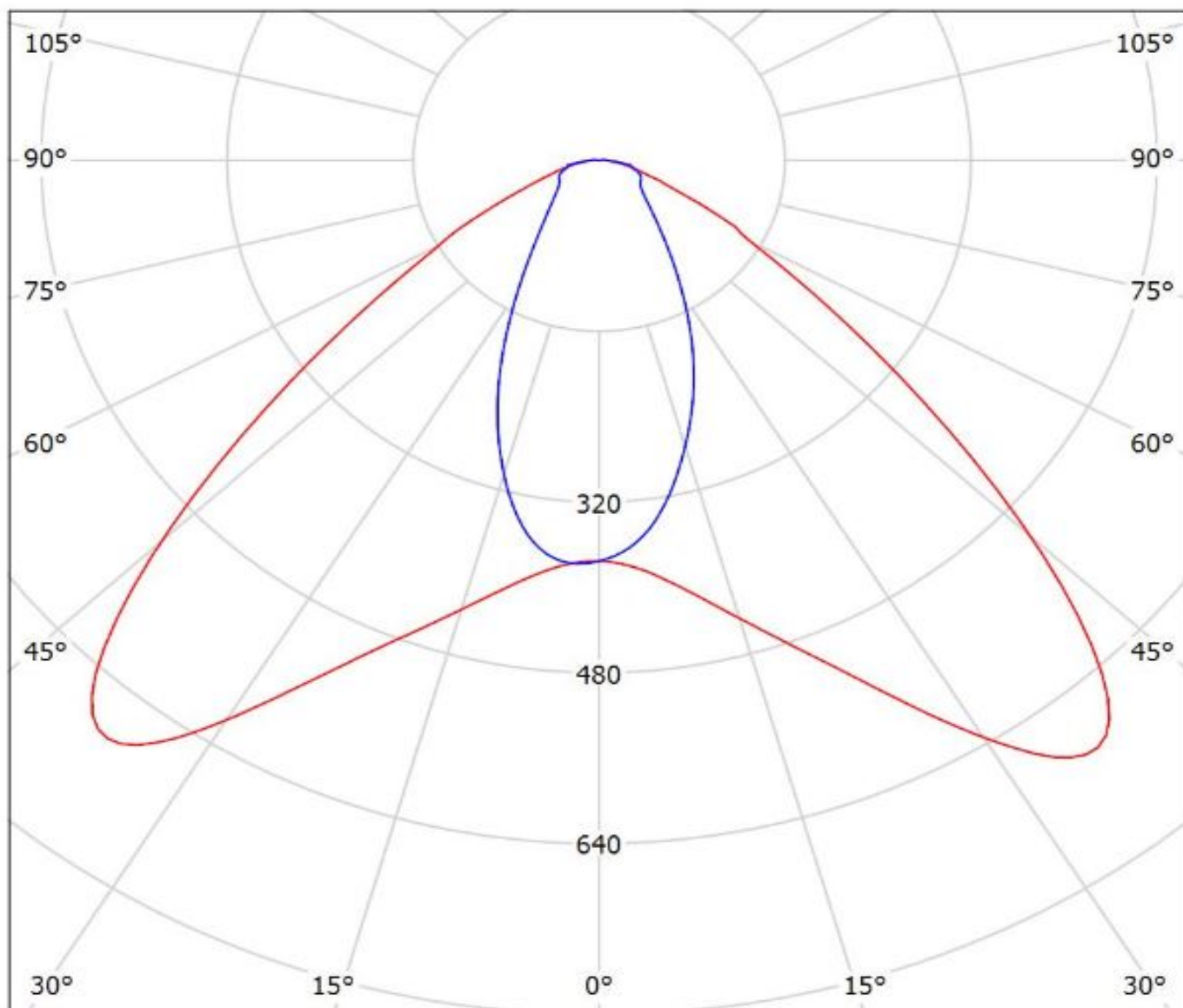

cd/klm

— C0 - C180 — C90 - C270

$\eta = 93\%$

Luminaire: LEDiL Oy C13936_STRADA-2X2-B2-STP_(NVSW319AE)
Lamps: 1 x Nichia_NVSW319AE_499.093lm@250mA_P=2.79052W_I=0.25A

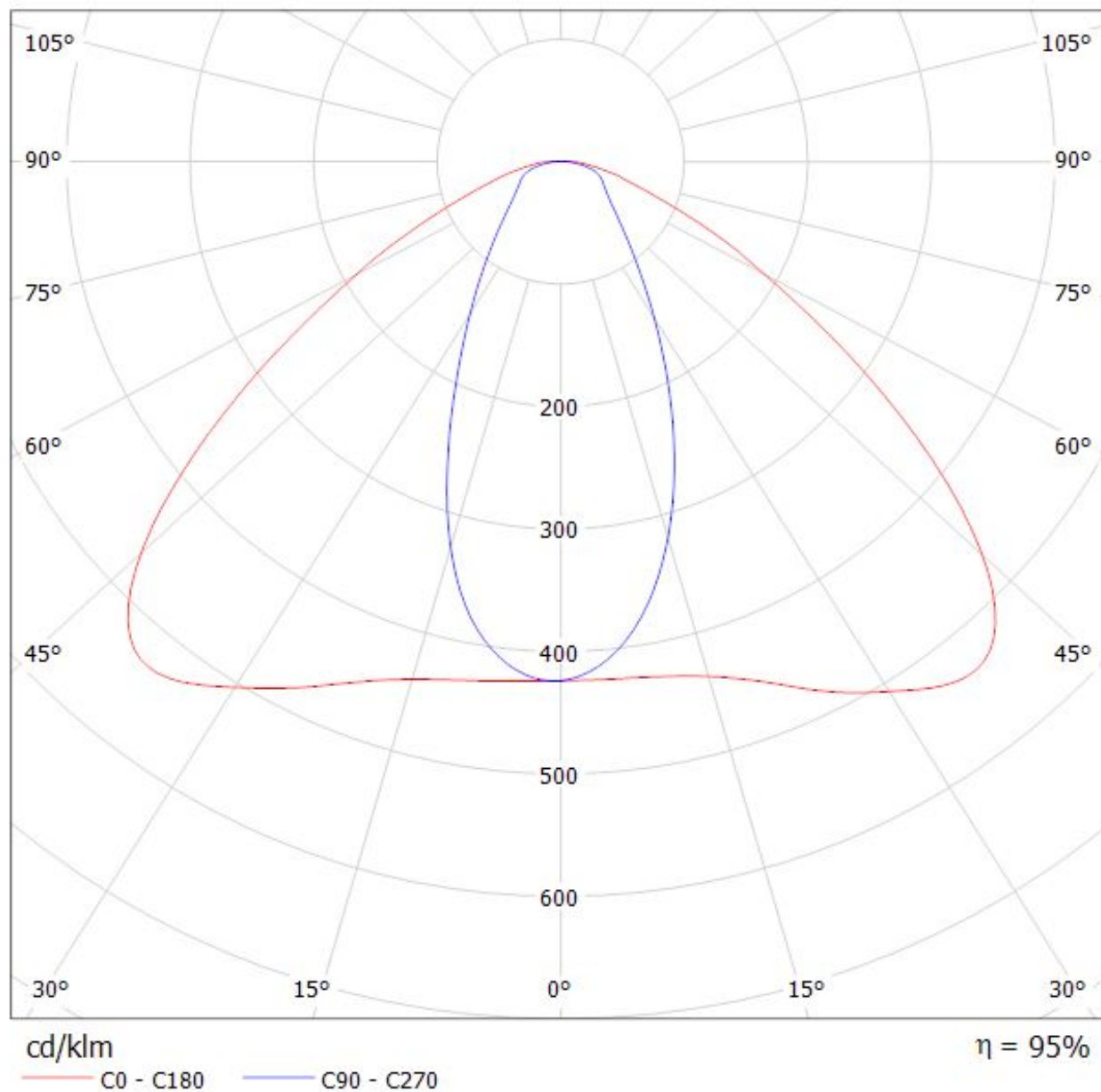

Luminaire: LEDiL Oy C13936_STRADA-2X2-B2-STP_(Oslon_Square_PC_2x2)
Lamps: 1 x Osram_Oslon_Square_PC_2x2_(GWCSSRM1.PC)
_411.322lm@250mA_P=2.85186W_I=0,2499A

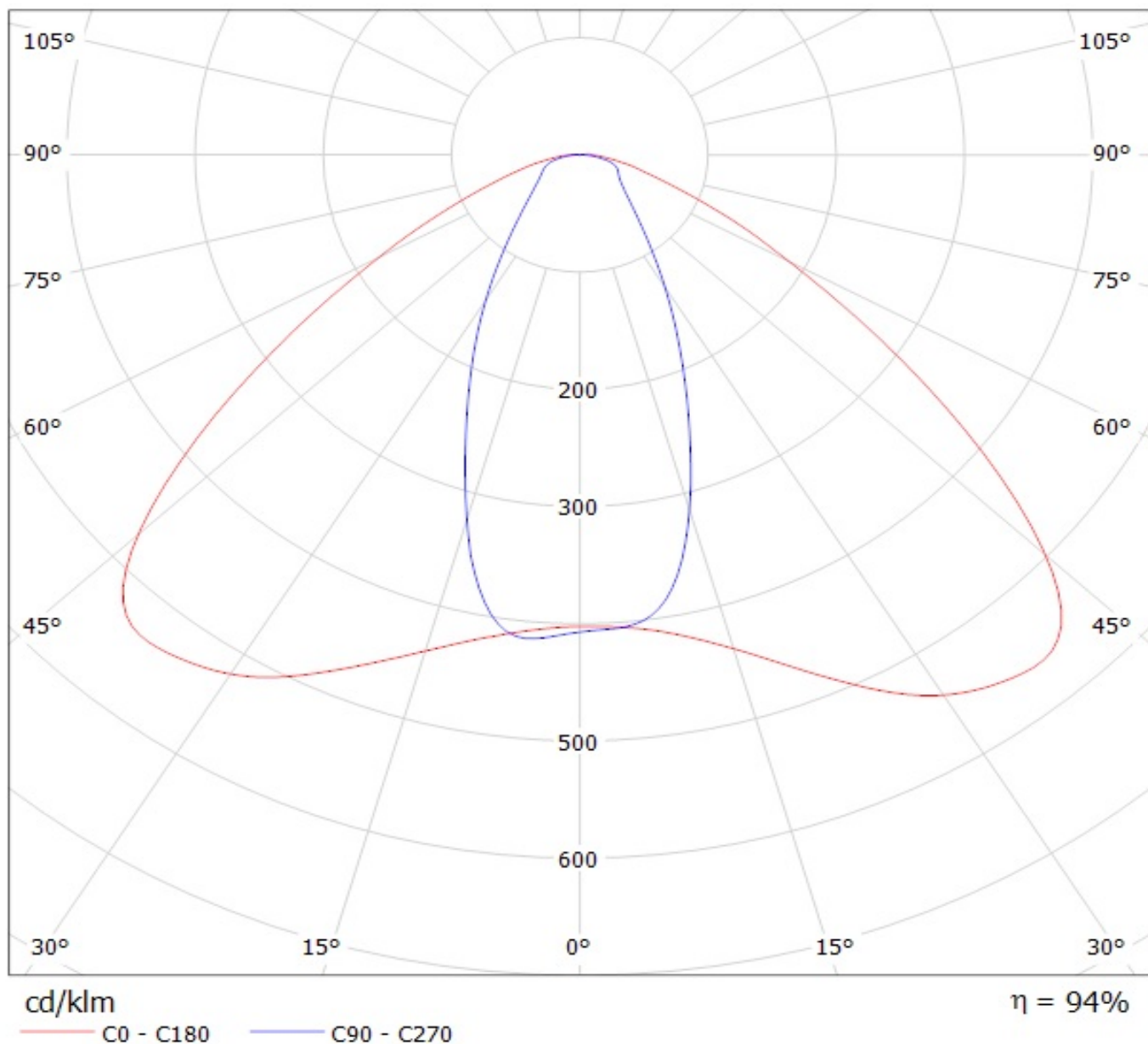

Luminaire: Ledil C13936_STRADA-2x2-B2-STP_(Square_Gen3)

Lamps: 1 x Osram_Square_Gen3_(GW_CSSRM2.PM)_461.082lm@250mA_P=2.79075W_η=0.250A

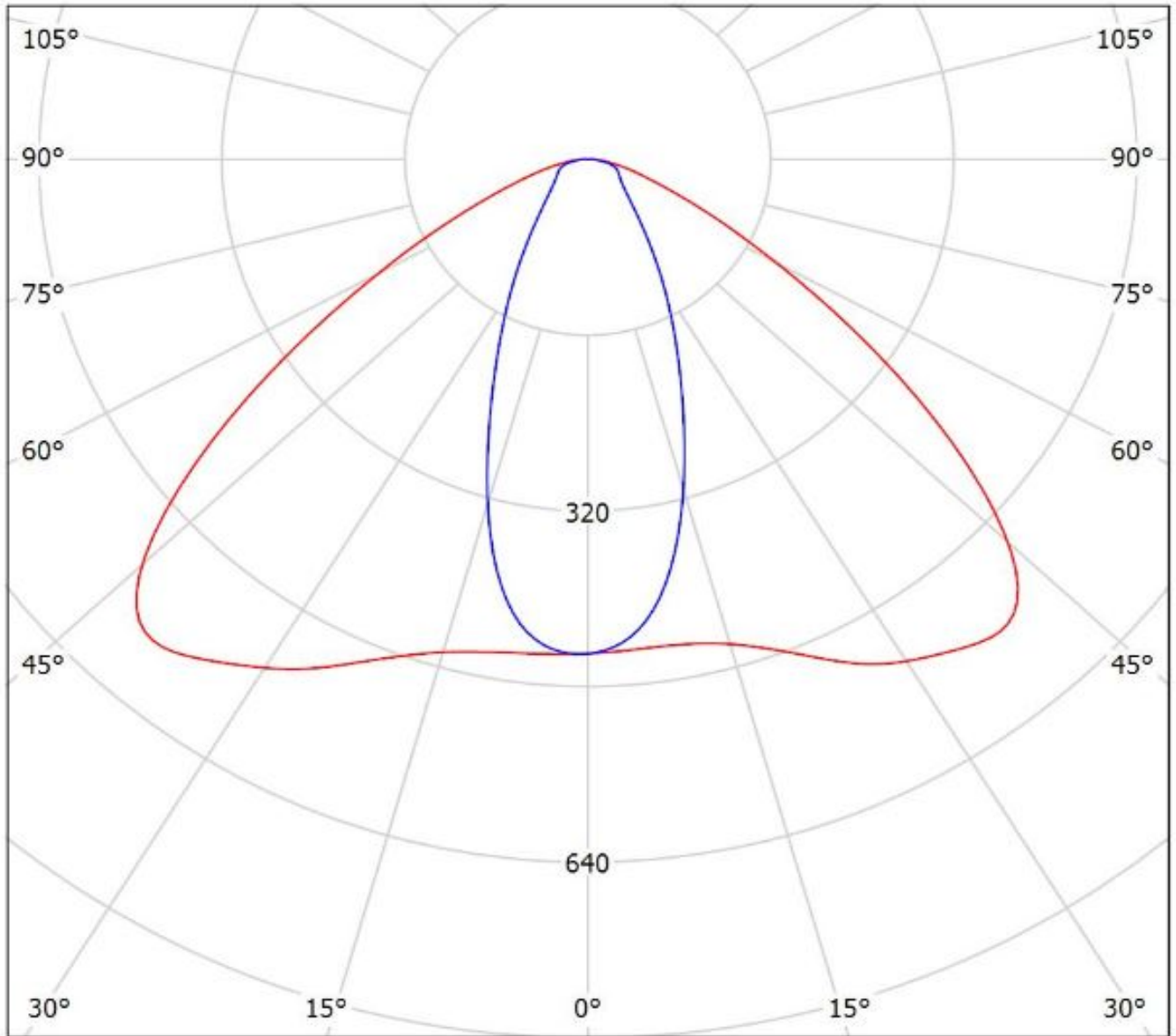

cd/klm

— C0 - C180

— C90 - C270

$\eta = 93\%$

Luminaire: LEDiL Oy C13936_STRADA-2X2-B2-STP_(Fortimo_F-Flex_2x8_740DAG3)
Lamps: 1 x Philips_Fortimo_F-Flex_2x8_740DAG3_1786.86lm@250mA_P=11.6092W_I=0.2498A

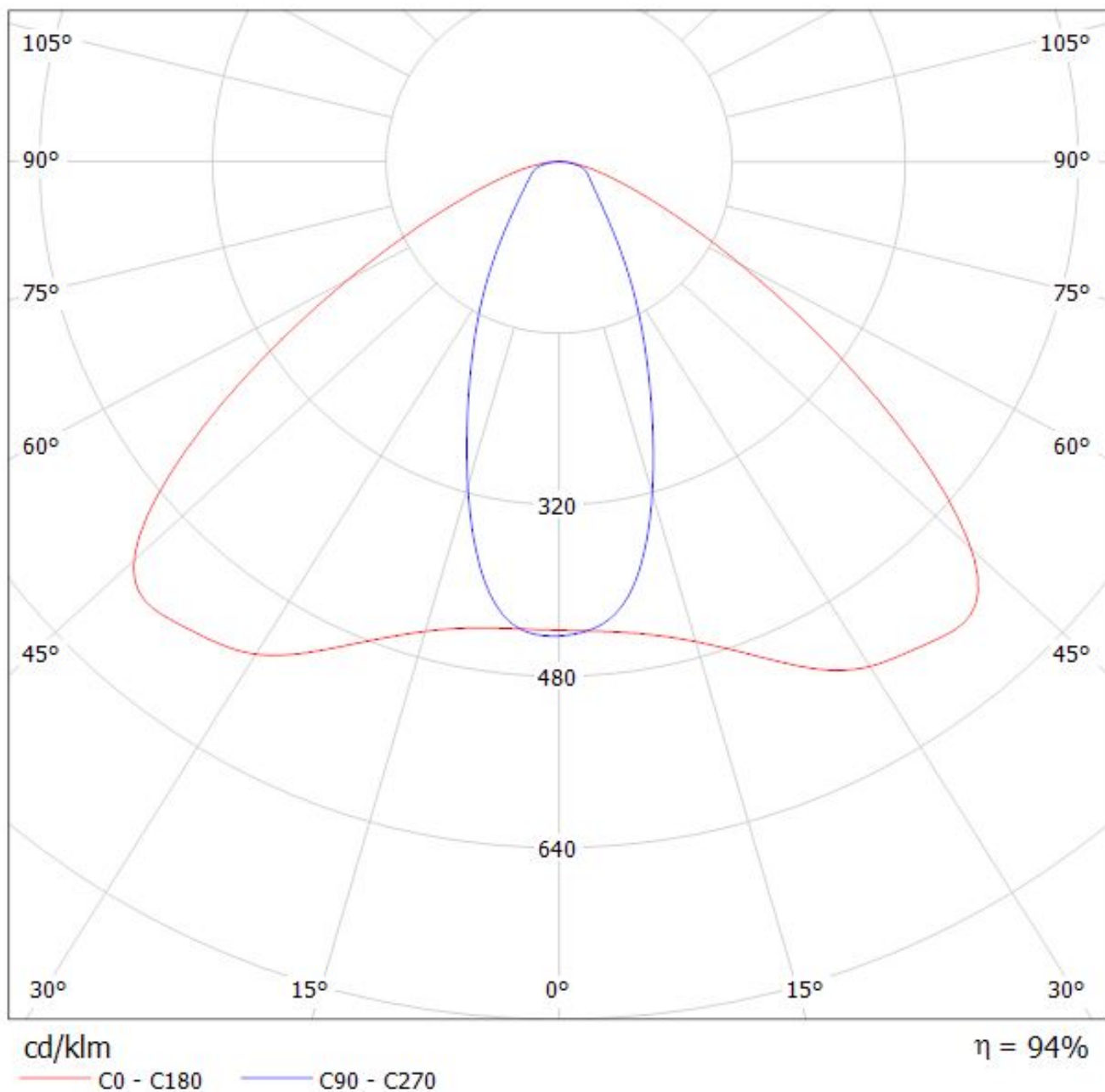

Luminaire: LEDiL Oy C13936_STRADA-2X2-B2-STP_(LH351Z) Eff.93.1%
Lamps: 1 x SAMSUNG_LH351Z_2x2_359.49lm@250mA_P=2.86371W_I=249.8mA

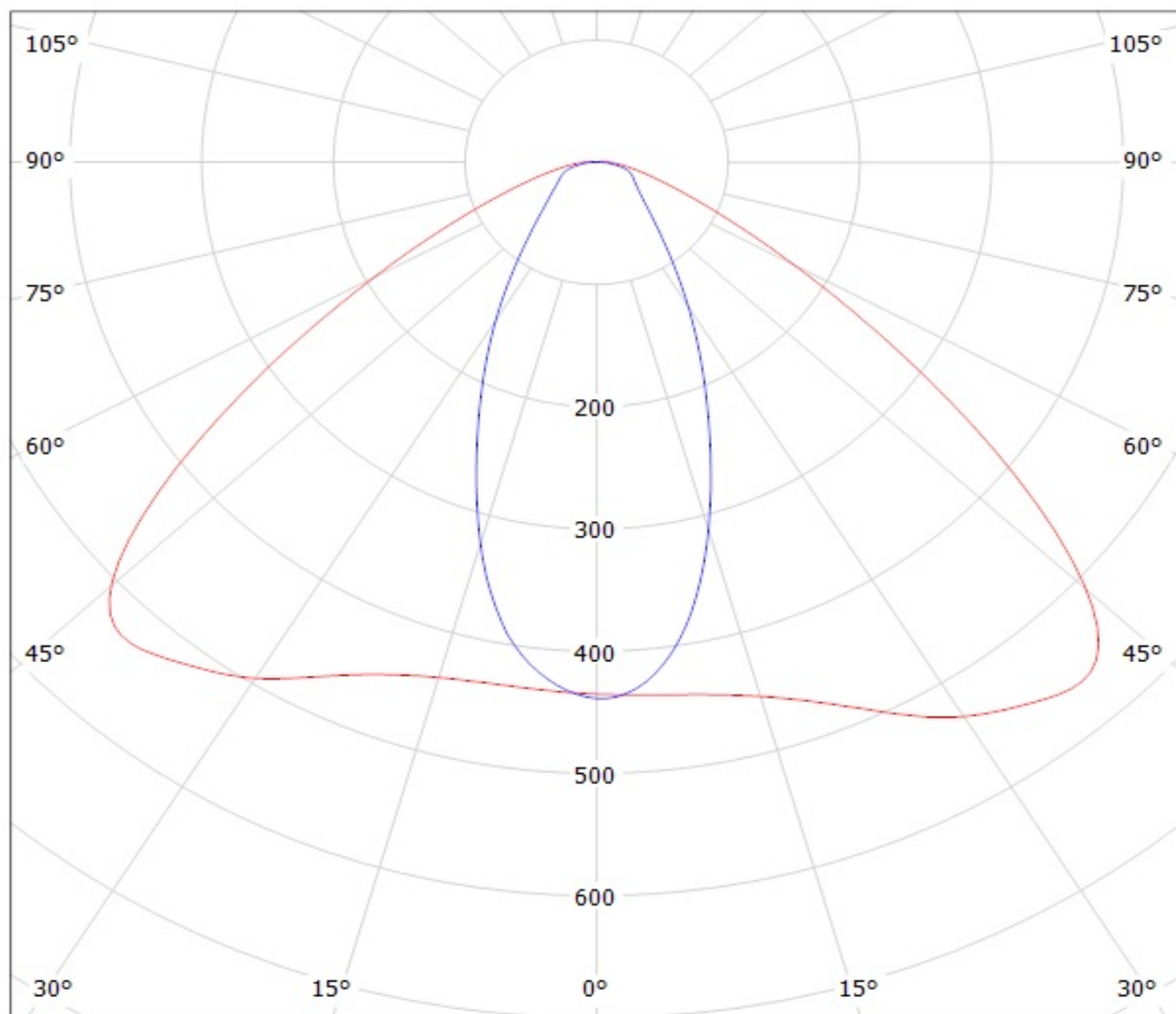

cd/klm

— C0 - C180 — C90 - C270

Luminaire: Ledil C13936_STRADA-2X2-B2-STP_(LH351B)

Lamps: 1 x Samsung_LH351B_2x2_444.178lm@250mA_P=2.8535W_I=0.25A

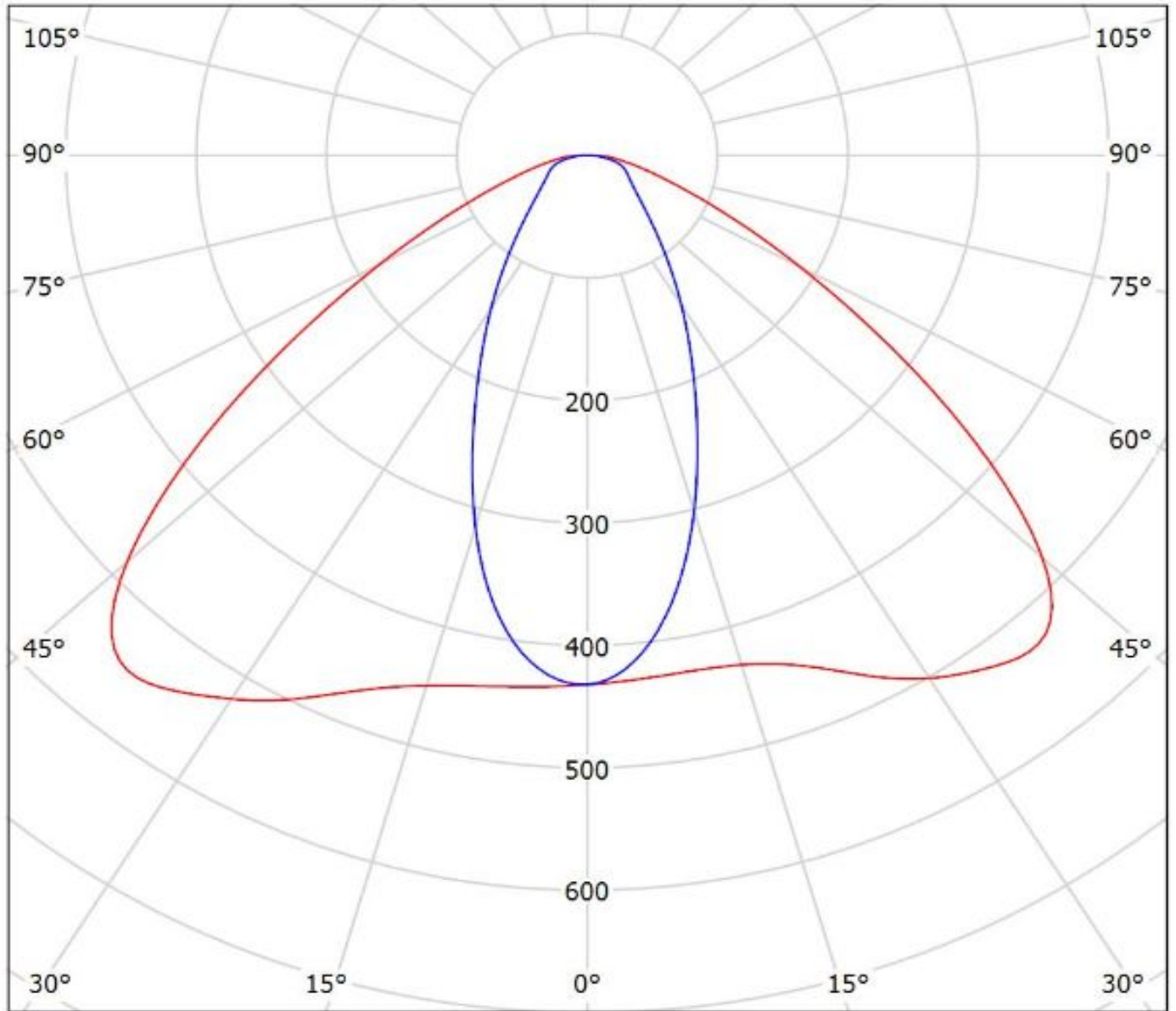

cd/klm

— C0 - C180

— C90 - C270

$\eta = 93\%$

Ledil C13936_STRADA-2X2-B2-STP_(TL1L4) / LDC (Polar)

Luminaire: Ledil C13936_STRADA-2X2-B2-STP_(TL1L4)

Lamps: 1 x Toshiba_TL1L4_2x2_(TL1L4-DW0)_472.639lm@250mA_CCT=6500K_P=2.9W_I=0.25A

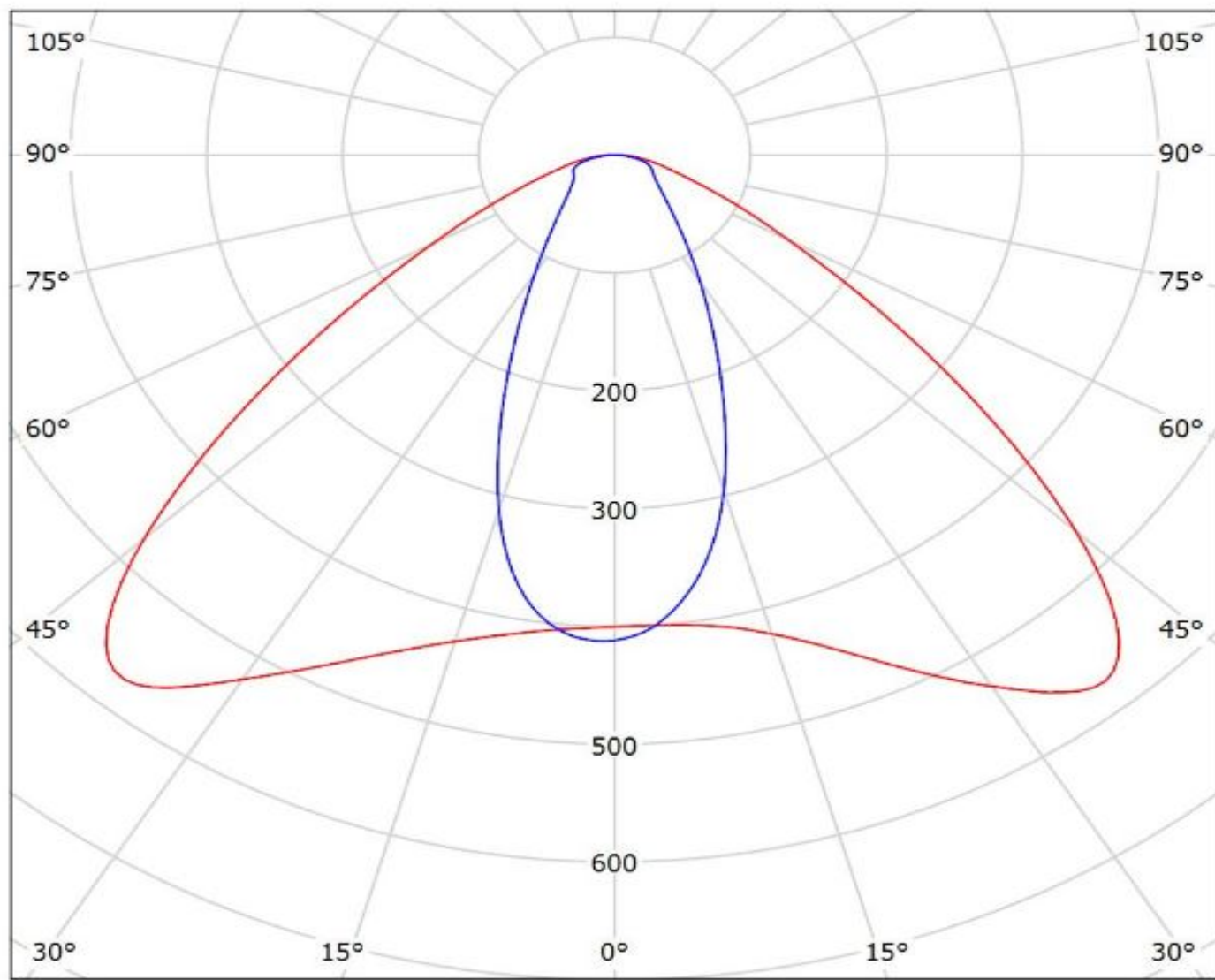

cd/klm

— C0 - C180 — C90 - C270

$\eta = 88\%$

Luminaire: LEDiL Oy C13936_STRADA-2X2-B2-STP_(Tridonic_Module_RLE_G1)
Lamps: 1 x Tridonic_Module_RLE_G1_4576.03lm@700mA_P=32.0681W_I=0.700A

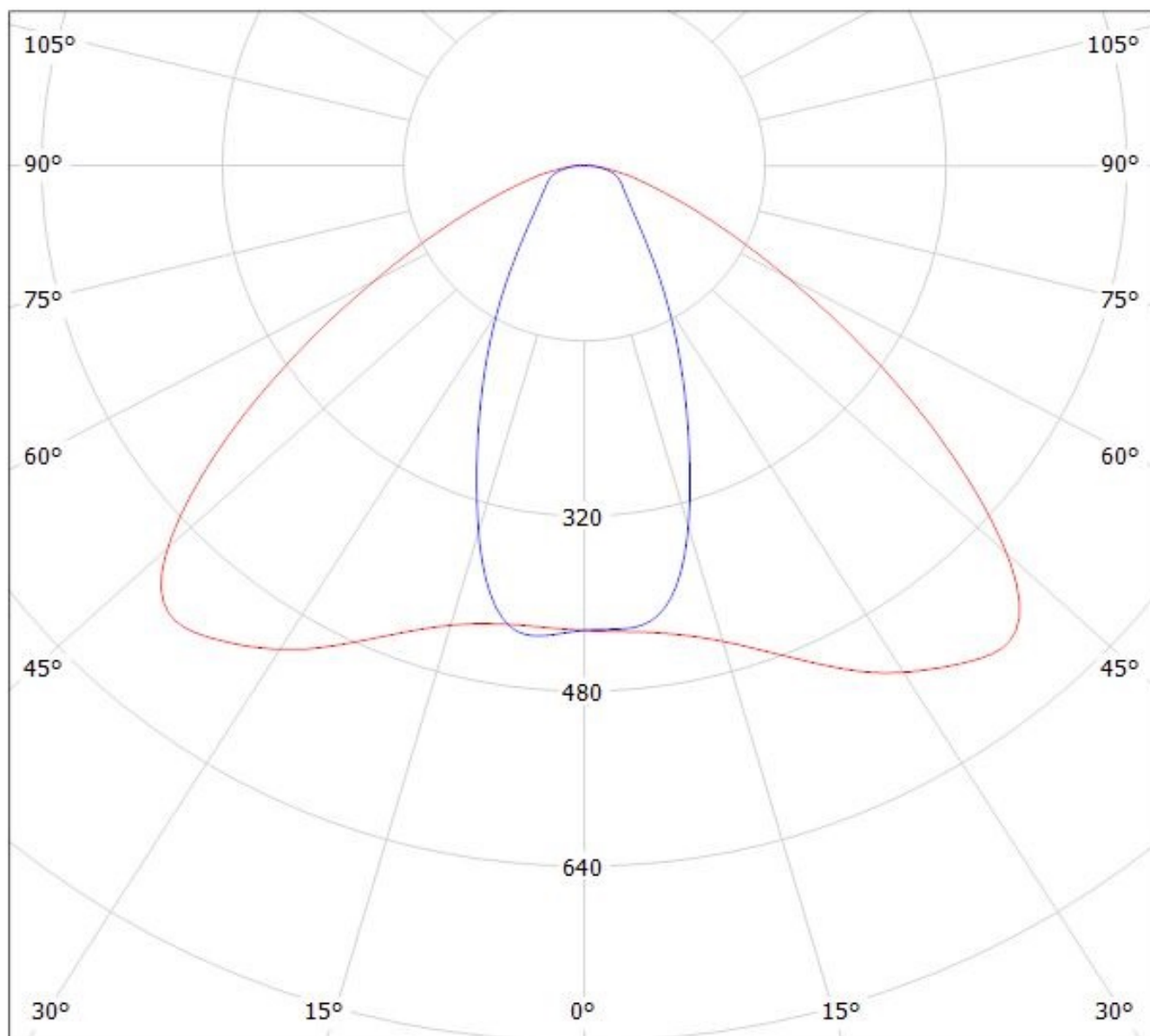

cd/klm

$\eta = 94\%$

— C0 - C180 — C90 - C270

Luminaire: LEDiL Oy C13936_STRADA-2X2-B2-STP_(Tridonic_Module_RLE_G1)
Lamps: 1 x Tridonic_Module_RLE_G1_4576.03lm@700mA_P=32.0681W_I=0.700A

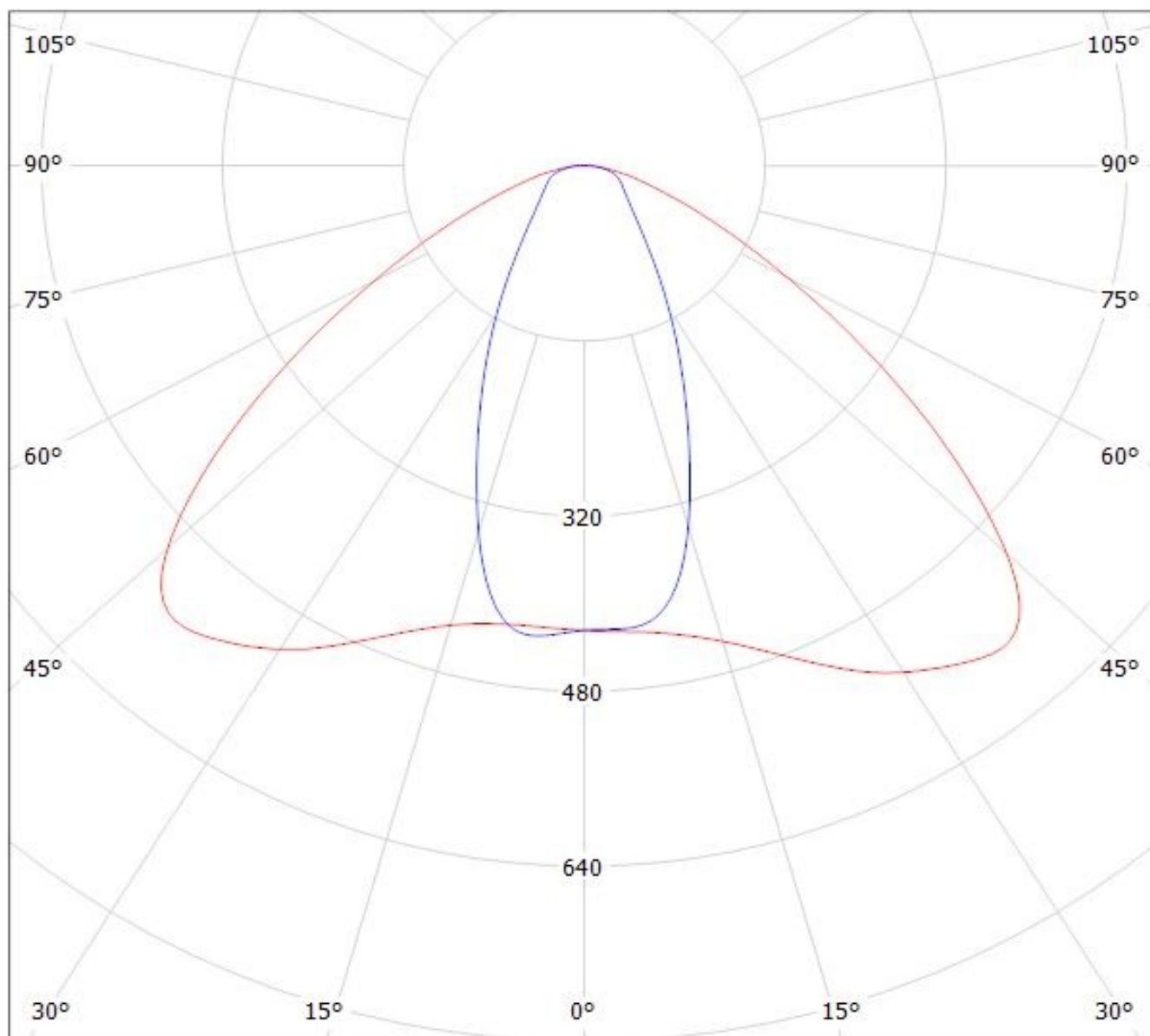

cd/klm

$\eta = 94\%$

— C0 - C180 — C90 - C270

Luminaire: LEDiL Oy C13936_STRADA-2X2-B2-STP_(Tridonic_Module_RLE_G1)
Lamps: 1 x Tridonic_Module_RLE_G1_2288lm@700mA_P=16W_I=0.700A

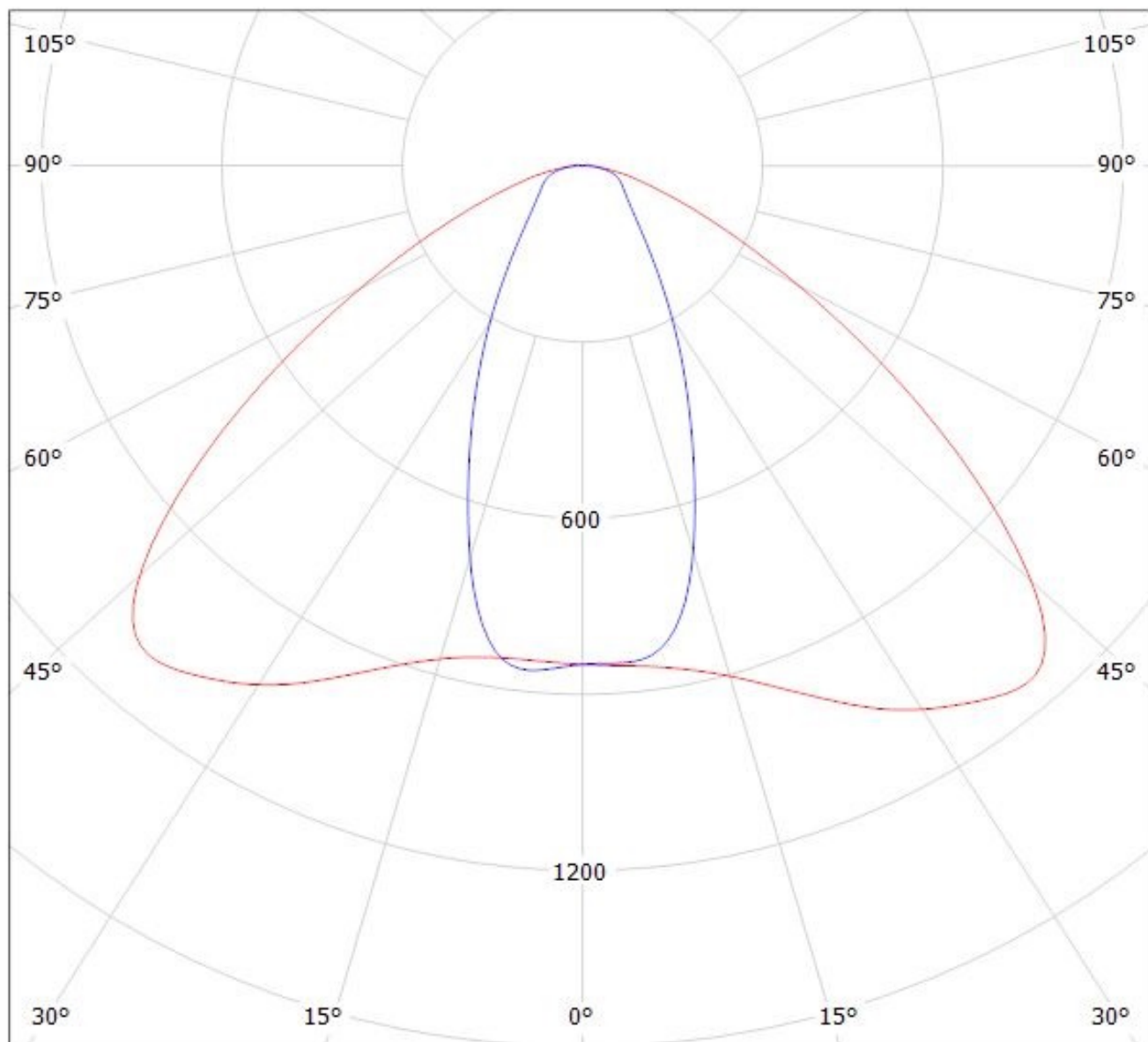

cd/klm

— C0 - C180 — C90 - C270

$\eta = 94\%$

Luminaire: LEDiL Oy C13936_STRADA-2X2-B2-STP_(Tridonic_Module_RLE_G1)
Lamps: 1 x Tridonic_Module_RLE_G1_2288lm@700mA_P=16W_I=0.700A

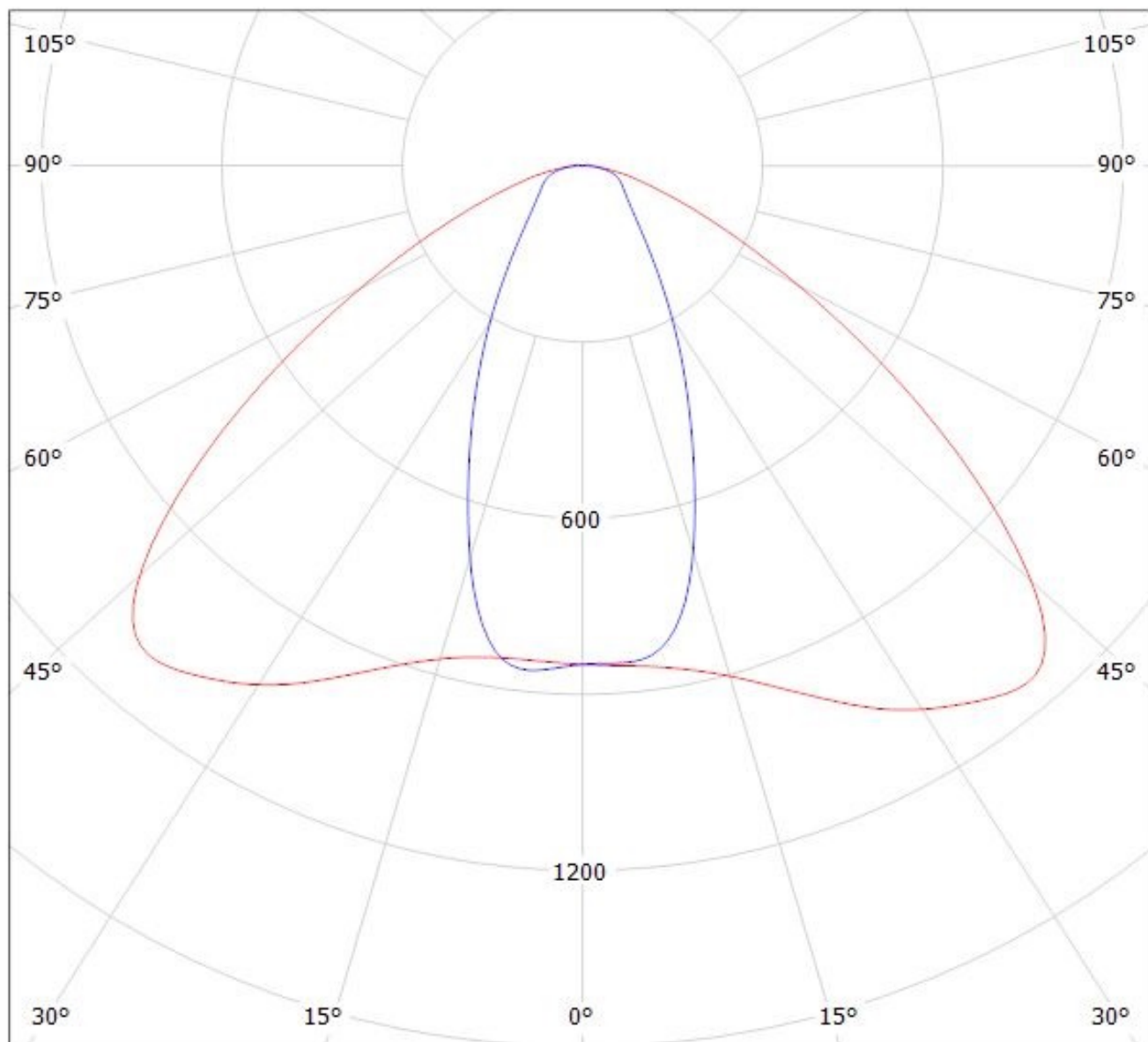

cd/klm

— C0 - C180 — C90 - C270

$\eta = 94\%$

NOTE: The typical divergence will be changed by different color, chip size and chip position tolerance. The typical total divergence is the full angle measured where the luminous intensity is half of the peak value.