

RF CHARACTERISTICS

Frequency range : **0 - 18 GHz**
Impedance : **50 Ohms**

Frequency (GHz)	DC - 3	3 - 8	8 - 12.4	12.4 - 18
VSWR max	1.20	1.30	1.40	1.50
Insertion loss max	0.20 dB	0.30 dB	0.40 dB	0.50 dB
Isolation min	80 dB	70 dB	60 dB	60 dB
Average power (*)	240 W	150 W	120 W	100 W

ELECTRICAL CHARACTERISTICS

Actuator : **LATCHING**
Nominal current ** : **160 mA**
Actuator voltage (Vcc) : **28V (24 to 30V)**
Terminals : **solder pins (250°C max. / 30 sec.)**
Indicator rating : **1 W / 30 V / 100 mA**
Self cut-off time : **40 ms < CT < 120 ms**
TTL inputs (E) - High level : **2.2 to 5.5 V / 800µA at 5.5 V**
- Low level : **0 to 0.8 V / 20µA at 0.8 V**

MECHANICAL CHARACTERISTICS

Connectors : **SMA female per MIL-C 39012**
Life : **2 million cycles**
Switching Time*** : **< 10 ms**
Construction : **Splashproof**
Weight : **< 100 g**

ENVIRONMENTAL CHARACTERISTICS

Operating temperature range : **-40°C to +85°C**
Storage temperature range : **-55°C to +85°C**

(* Average power at 25°C per RF Path)

(** At 25° C ±10%)

(*** Nominal voltage ; 25° C)



PAGE 2/2

ISSUE 09-03-21

SERIE : SPDT ZC

PART NUMBER : R585463300

DRAWING

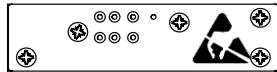
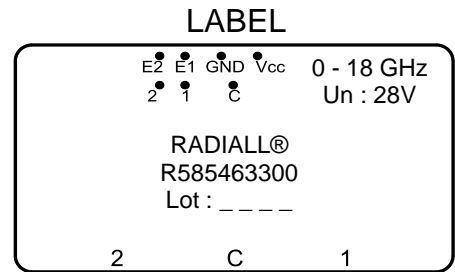
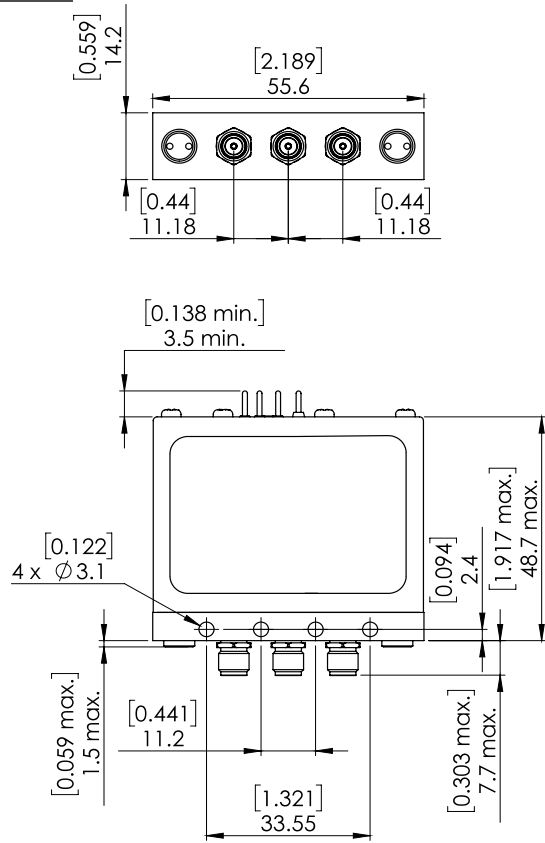

General tolerances : ±0,5 mm [0,02 in]

SCHEMATIC DIAGRAM

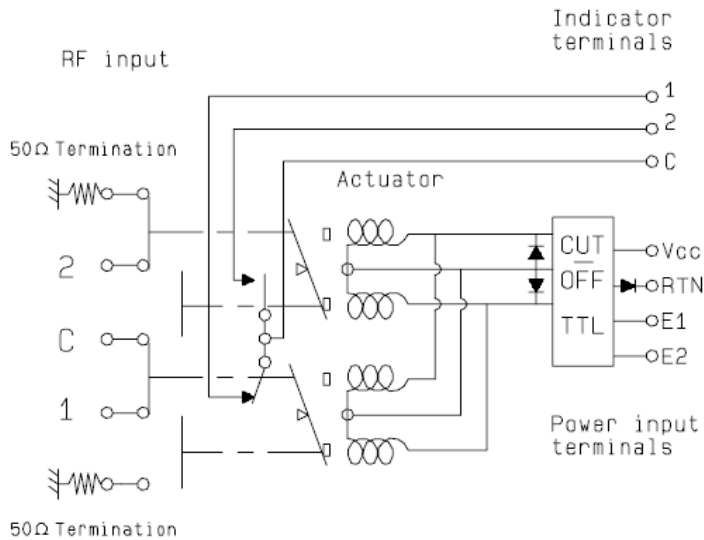

TTL input	RF Continuity	Ind.
E1=1 / E2=0	C↔1 / 2↔50Ω	C . 1
E1=0 / E2=1	C↔2 / 1↔50Ω	C . 2
E1=0 / E2=0	Memory	-
E1=1 / E2=1	Forbidden	-