



**Please note that Cypress is an Infineon Technologies Company.**

The document following this cover page is marked as “Cypress” document as this is the company that originally developed the product. Please note that Infineon will continue to offer the product to new and existing customers as part of the Infineon product portfolio.

**Continuity of document content**

The fact that Infineon offers the following product as part of the Infineon product portfolio does not lead to any changes to this document. Future revisions will occur when appropriate, and any changes will be set out on the document history page.

**Continuity of ordering part numbers**

Infineon continues to support existing part numbers. Please continue to use the ordering part numbers listed in the datasheet for ordering.

CY96320 series is based on Cypress advanced 16FX architecture (16-bit with instruction pipeline for RISC-like performance). The CPU uses the same instruction set as the established 16LX series - thus allowing for easy migration of 16LX Software to the new 16FX products. 16FX improvements compared to the previous generation include significantly improved performance - even at the same operation frequency, reduced power consumption and faster start-up time.

For highest processing speed at optimized power consumption an internal PLL can be selected to supply the CPU with up to 56 MHz operation frequency from an external 4 MHz resonator. The result is a minimum instruction cycle time of 17.8 ns going together with excellent EMI behavior. An on-chip clock modulation circuit significantly reduces emission peaks in the frequency spectrum. The emitted power is minimized by the on-chip voltage regulator that reduces the internal CPU voltage. A flexible clock tree allows to select suitable operation frequencies for peripheral resources independent of the CPU speed.

## Features

### Technology

- 0.18 μm CMOS

### CPU

- F<sup>2</sup>MC-16FX CPU
- Up to 56 MHz internal, 17.8 ns instruction cycle time
- Optimized instruction set for controller applications (bit, byte, word and long-word data types; 23 different addressing modes; barrel shift; variety of pointers)
- 8-byte instruction execution queue
- Signed multiply (16-bit × 16-bit) and divide (32-bit/16-bit) instructions available

### System Clock

- On-chip PLL clock multiplier (×1–×25, x1 when PLL stop)
- 3 MHz–16 MHz external crystal oscillator clock (maximum frequency when using ceramic resonator depends on Q-factor).
- Up to 56 MHz external clock
- 32 kHz–100 kHz subsystem quartz clock
- 100 kHz/2 MHz internal RC clock for quick and safe startup, oscillator stop detection, watchdog
- Clock source selectable from main- and subclock oscillator (part number suffix “W”) and on-chip RC oscillator, independently for CPU and 2 clock domains of peripherals.
- Low Power Consumption - 13 operating modes: (different Run, Sleep, Timer modes, Stop mode)
- Clock modulator

### On-chip Voltage Regulator

- Internal voltage regulator supports reduced internal MCU voltage, offering low EMI and low power consumption figures

### Low Voltage Reset

- Reset is generated when supply voltage is below minimum.

### Code Security

- Protects ROM content from unintended read-out

### Memory Patch Function

- Replaces ROM content
- Can also be used to implement embedded debug support

### DMA

- Automatic transfer function independent of CPU, can be assigned freely to resources

### Interrupts

- Fast Interrupt processing
- 8 programmable priority levels
- Non-Maskable Interrupt (NMI)

### Timers

- Three independent clock timers (23-bit RC clock timer, 23-bit Main clock timer, 17-bit Sub clock timer)
- Watchdog Timer

### CAN

- Supports CAN protocol version 2.0 part A and B
- ISO16845 certified
- Bit rates up to 1 Mbit/s
- 32 message objects
- Each message object has its own identifier mask
- Programmable FIFO mode (concatenation of message objects)
- Maskable interrupt
- Disabled Automatic Retransmission mode for Time Triggered CAN applications
- Programmable loop-back mode for self-test operation

### USART

- Full duplex USARTs (SCI/LIN)
- Wide range of baud rate settings using a dedicated reload timer
- Special synchronous options for adapting to different synchronous serial protocols
- LIN functionality working either as master or slave LIN device

## I<sup>2</sup>C

- Up to 400 kbps
- Master and Slave functionality, 8-bit and 10-bit addressing

## A/D Converter

- SAR-type
- 10-bit resolution
- Signals interrupt on conversion end, single conversion mode, continuous conversion mode, stop conversion mode, activation by software, external trigger or reload timer

## Reload Timers

- 16-bit wide
- Prescaler with  $1/2^1$ ,  $1/2^2$ ,  $1/2^3$ ,  $1/2^4$ ,  $1/2^5$ ,  $1/2^6$  of peripheral clock frequency
- Event count function

## Free Running Timers

- Signals an interrupt on overflow, supports timer clear upon match with Output Compare (0, 4), Prescaler with 1,  $1/2^1$ ,  $1/2^2$ ,  $1/2^3$ ,  $1/2^4$ ,  $1/2^5$ ,  $1/2^6$ ,  $1/2^7$ ,  $1/2^8$  of peripheral clock frequency

## Input Capture Units

- 16-bit wide
- Signals an interrupt upon external event
- Rising edge, falling edge or rising & falling edge sensitive

## Output Compare Units

- 16-bit wide
- Signals an interrupt when a match with 16-bit I/O Timer occurs
- A pair of compare registers can be used to generate an output signal.

## Programmable Pulse Generator

- 16-bit down counter, cycle and duty setting registers
- Interrupt at trigger, counter borrow and/or duty match
- PWM operation and one-shot operation
- Internal prescaler allows 1, 1/4, 1/16, 1/64 of peripheral clock as counter clock and Reload timer overflow as clock input
- Can be triggered by software or reload timer

## Real Time Clock

- Can be clocked either from sub oscillator (devices with part number suffix "W"), main oscillator or from the RC oscillator
- Facility to correct oscillation deviation of Sub clock or RC oscillator clock (clock calibration)
- Read/write accessible second/minute/hour registers
- Can signal interrupts every half second/second/minute/hour/day
- Internal clock divider and prescaler provide exact 1 s clock

## External Interrupts

- Edge sensitive or level sensitive
- Interrupt mask and pending bit per channel
- Each available CAN channel RX has an external interrupt for wake-up
- Selected USART channels SIN have an external interrupt for wake-up

## Non Maskable Interrupt

- Disabled after reset
- Once enabled, can not be disabled other than by reset.
- Level high or level low sensitive
- Pin shared with external interrupt 0.

## External Bus Interface

- 8-bit or 16-bit bidirectional data
- Up to 24-bit addresses
- 6 chip select signals
- Multiplexed address/data lines
- Wait state request
- External bus master possible
- Timing programmable

## I/O Ports

- Virtually all external pins can be used as general purpose I/O
- All push-pull outputs (except when used as I2C SDA/SCL line)
- Bit-wise programmable as input/output or peripheral signal
- Bit-wise programmable input enable
- Bit-wise programmable input levels: Automotive / CMOS-Schmitt trigger / TTL
- Bit-wise programmable pull-up resistor
- Bit-wise programmable output driving strength for EMI optimization

## Package

- 80-pin plastic LQFP

## Flash Memory

- Supports automatic programming, Embedded Algorithm
- Write/Erase/Erased-Suspend/Resume commands
- A flag indicating completion of the algorithm
- Number of erase cycles: 10,000 times
- Data retention time: 20 years
- Erase can be performed on each sector individually
- Sector protection
- Flash Security feature to protect the content of the Flash
- Low voltage detection during Flash erase

**Contents**

<b>Product Lineup</b> .....	<b>4</b>	Turn on Sequence of Power Supply	
<b>Block Diagram</b> .....	<b>6</b>	to A/D Converter and Analog Inputs .....	50
<b>Pin Assignment</b> .....	<b>7</b>	Pin Handling when Not Using the A/D Converter .....	50
<b>Pin Function Description</b> .....	<b>8</b>	Notes on Power-on .....	50
<b>Pin Circuit Type</b> .....	<b>10</b>	Stabilization of Power Supply Voltage .....	50
<b>I/O Circuit Type</b> .....	<b>11</b>	Serial Communication .....	50
<b>Memory Map</b> .....	<b>14</b>	<b>Electrical Characteristics</b> .....	<b>51</b>
<b>RAM Start/End and External Bus End Addresses</b> .....	<b>15</b>	Absolute Maximum Ratings .....	51
<b>User ROM Memory Map for Flash Devices</b> .....	<b>16</b>	Recommended Operating Conditions .....	53
<b>Serial Programming Communication Interface</b> .....	<b>17</b>	DC Characteristics .....	54
<b>I/O Map</b> .....	<b>18</b>	AC Characteristics .....	60
<b>Interrupt Vector Table</b> .....	<b>45</b>	Analog Digital Converter .....	76
<b>Handling Devices</b> .....	<b>48</b>	Low Voltage Detector characteristics .....	80
Latch-up Prevention .....	48	Flash Memory Program/Erase Characteristics .....	81
Unused Pins Handling .....	48	<b>Example Characteristics</b> .....	<b>82</b>
External Clock Usage .....	48	<b>Package Dimension CY96(F)32x LQFP 80</b> .....	<b>86</b>
Unused Sub Clock Signal .....	49	<b>Ordering Information</b> .....	<b>87</b>
Notes on PLL Clock Mode Operation .....	49	MCU with CAN Controller .....	87
Power Supply Pins (VCC/VSS) .....	49	<b>Revision History</b> .....	<b>88</b>
Crystal Oscillator and Ceramic Resonator Circuit .....	50	<b>Major Changes in this Edition</b> .....	<b>90</b>
		<b>Document History Page</b> .....	<b>91</b>
		<b>Sales, Solutions, and Legal Information</b> .....	<b>92</b>

## 1. Product Lineup

Features		CY96V300B	CY96(F)32x
Product type		Evaluation sample	Flash product: CY96F32x Mask ROM product: CY9632x
Product options			
YS		NA	Low voltage reset persistently on / Single clock devices
RS			Low voltage reset can be disabled / Single clock devices
YW			Low voltage reset persistently on / Dual clock devices
RW			Low voltage reset can be disabled / Dual clock devices
AS			No CAN / Low voltage reset can be disabled / Single clock devices
AW			No CAN / Low voltage reset can be disabled / Dual clock devices
Flash/ROM	RAM		
288 KB	12 KB	ROM/Flash memory emulation by external RAM, 92 KB internal RAM	CY96F326Y, CY96F326R, CY96F326A
Package		BGA416	LQH080
DMA		16 channels	4 channels
USART		10 channels	4 channels
I2C		2 channels	1 channel
A/D Converter		40 channels	18 channels
A/D Converter Reference Voltage switch		yes	No
16-bit Reload Timer		6 channels + 1 channel (for PPG)	4 channels + 1 channel (for PPG)
16-bit Free-Running Timer		4 channels	4 channels
16-bit Output Compare		12 channels	6 channels
16-bit Input Capture		12 channels	12 channels
16-bit Programmable Pulse Generator		20 channels	20 channels
CAN Interface		5 channels	2 channels (except CY96F326A)
External Interrupts		16 channels	15 channels
Non-Maskable Interrupt			1 channel
Real Time Clock			1
I/O Ports		136	64 for part number with suffix "W", 66 for part number with suffix "S"
External bus interface			Yes

Features	CY96V300B	CY96(F)32x
Chip select		6 signals
Clock output function		2 channels
Low voltage reset		Yes
On-chip RC-oscillator		Yes

## 2. Block Diagram

Figure 1. Block Diagram of CY96(F)32x

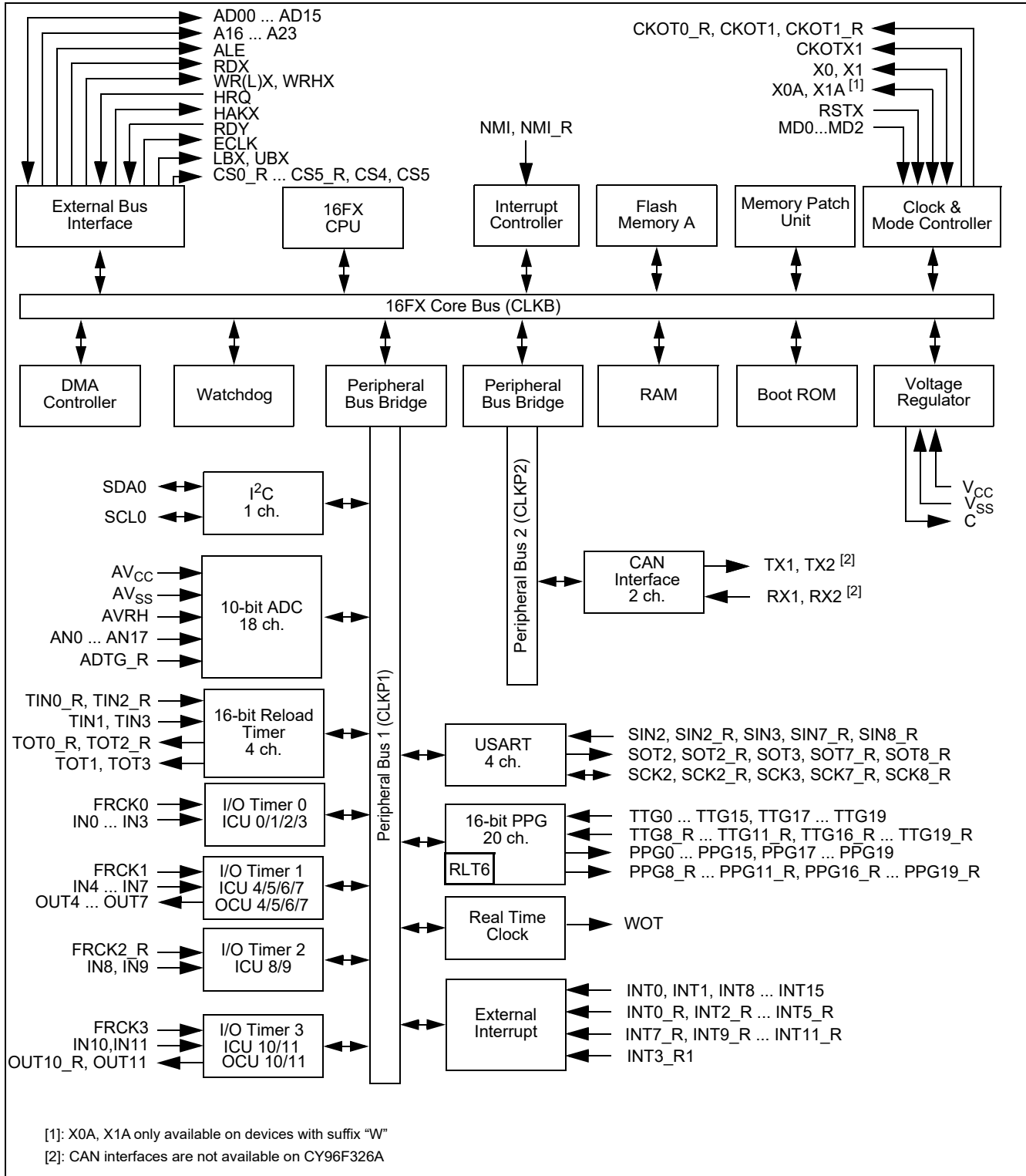

### 3. Pin Assignment

Figure 2. Pin Assignment of CY96(F)32x

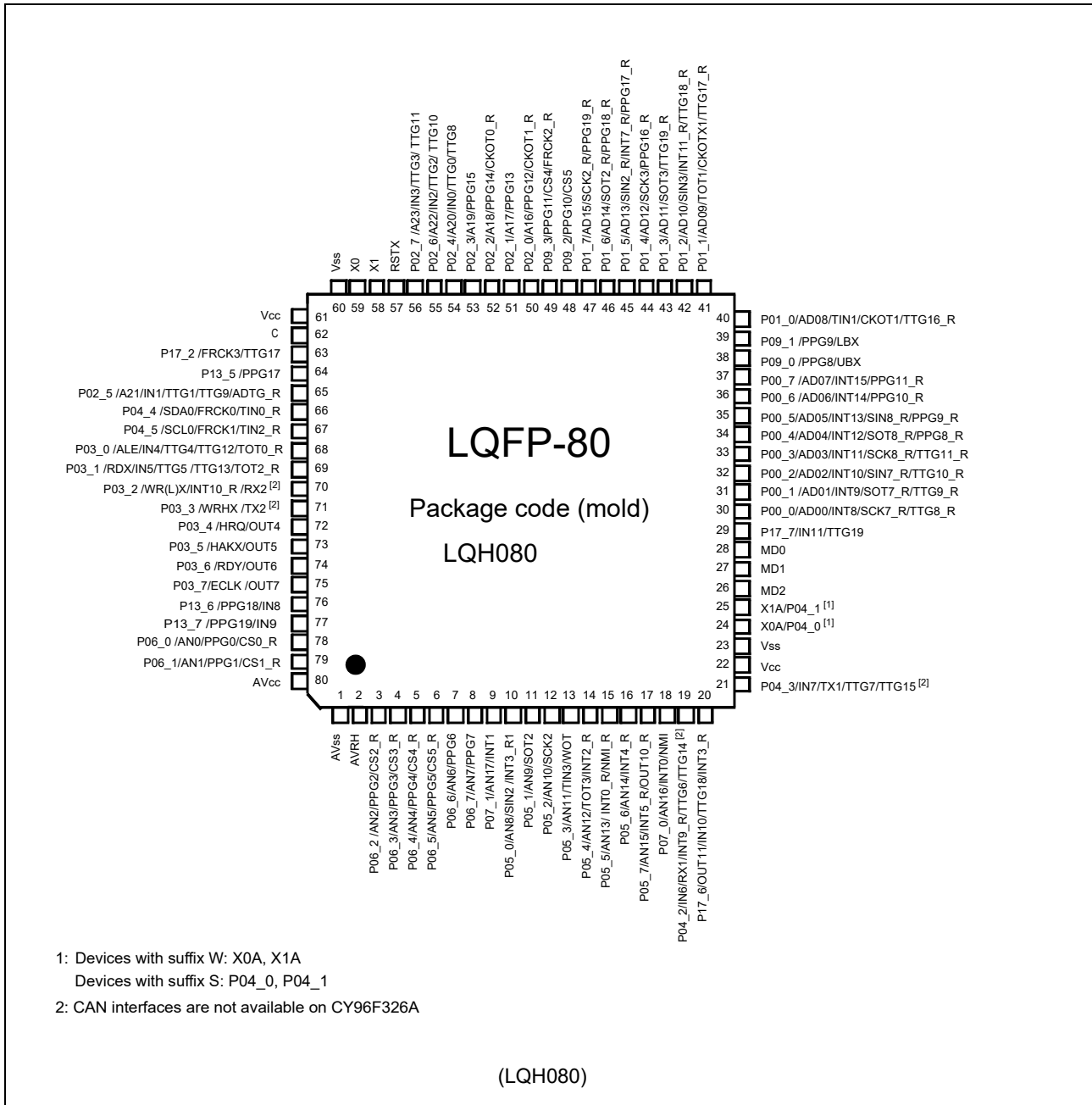



## 4. Pin Function Description

**Table 1: Pin Function Description**

Pin Name	Feature	Description
ADn	External bus	External bus interface (multiplexed mode) address output and data input/output
ADTG_R	ADC	Relocated A/D converter trigger input
ALE	External bus	External bus Address Latch Enable output
An	External bus	External bus address output
ANn	ADC	A/D converter channel n input
AV <sub>CC</sub>	Supply	Analog circuits power supply
AVRH	ADC	A/D converter high reference voltage input
AV <sub>SS</sub>	Supply	Analog circuits power supply
C	Voltage regulator	Internally regulated power supply stabilization capacitor pin
CKOTn	Clock output function	Clock Output function n output
CKOTn_R	Clock output function	Relocated Clock Output function n output
CKOTXn	Clock output function	Clock Output function n inverted output
ECLK	External bus	External bus clock output
CSn	External bus	External bus chip select n output
CSn_R	External bus	Relocated External bus chip select n output
FRCKn	Free Running Timer	Free Running Timer n input
FRCKn_R	Free Running Timer	Relocated Free Running Timer n input
HAKX	External bus	External bus Hold Acknowledge
HRQ	External bus	External bus Hold Request
INn	ICU	Input Capture Unit n input
INTn	External Interrupt	External Interrupt n input
INTn_R	External Interrupt	Relocated External Interrupt n input
LBX	External bus	External Bus Interface Lower Byte select strobe output
MDn	Core	Input pins for specifying the operating mode.
NMI	External Interrupt	Non-Maskable Interrupt input
NMI_R	External Interrupt	Relocated Non-Maskable Interrupt input
OUTn	OCU	Output Compare Unit n waveform output
OUTn_R	OCU	Relocated Output Compare Unit n waveform output
Pxx_n	GPIO	General purpose IO
PPGn	PPG	Programmable Pulse Generator n output
PPGn_R	PPG	Relocated Programmable Pulse Generator n output
RDX	External bus	External bus interface read strobe output

**Table 1: Pin Function Description**

Pin Name	Feature	Description
RDY	External bus	External bus interface external wait state request input
RSTX	Core	Reset input
RXn	CAN	CAN interface n RX input
SCKn	USART	USART n serial clock input/output
SCKn_R	USART	Relocated USART n serial clock input/output
SCLn	I2C	I2C interface n clock I/O input/output
SDAn	I2C	I2C interface n serial data I/O input/output
SINn	USART	USART n serial data input
SINn_R	USART	Relocated USART n serial data input
SOTn	USART	USART n serial data output
SOTn_R	USART	Relocated USART n serial data output
TINn	Reload Timer	Reload Timer n event input
TINn_R	Reload Timer	Relocated Reload Timer n event input
TOTn	Reload Timer	Reload Timer n output
TOTn_R	Reload Timer	Relocated Reload Timer n output
TTGn	PPG	Programmable Pulse Generator n trigger input
TTGn_R	PPG	Relocated Programmable Pulse Generator n trigger input
TXn	CAN	CAN interface n TX output
UBX	External bus	External Bus Interface Upper Byte select strobe output
V <sub>CC</sub>	Supply	Power supply
V <sub>SS</sub>	Supply	Power supply
WOT	RTC	Real Timer clock output
WRHX	External bus	External bus High byte write strobe output
WRLX/WRX	External bus	External bus Low byte / Word write strobe output
X0	Clock	Oscillator input
X0A	Clock	Subclock Oscillator input (only for devices with suffix "W")
X1	Clock	Oscillator output
X1A	Clock	Subclock Oscillator output (only for devices with suffix "W")

## 5. Pin Circuit Type

Table 2: Pin Circuit Types

LQH080	
Pin no.	Circuit Type <sup>[1]</sup>
1	Supply
2	G
3 to 18	I
19 to 21	H
22,23	Supply
24,25	B <sup>[2]</sup>
24,25	H <sup>[3]</sup>
26 to 28	C
29 to 56	H
57	E
58,59	A
60,61	Supply
62	F
63 to 65	H
66,67	N
68 to 77	H
78 to 79	I
80	Supply

[1]: Please refer to “[I/O Circuit Type](#)” for details on the I/O circuit types

[2]: Devices with suffix “W”

[3]: Devices without suffix “W”

## 6. I/O Circuit Type

Type	Circuit	Remarks
A		<p>High-speed oscillation circuit:</p> <ul style="list-style-type: none"> <li>■ Programmable between oscillation mode (external crystal or resonator connected to X0/X1 pins) and Fast external Clock Input (FCI) mode (external clock connected to X0 pin)</li> <li>■ Programmable feedback resistor = approx. <math>2 * 0.5 \text{ M}\Omega</math>. Feedback resistor is grounded in the center when the oscillator is disabled or in FCI mode</li> </ul>
B		<p>Low-speed oscillation circuit:</p> <ul style="list-style-type: none"> <li>■ Programmable feedback resistor = approx. <math>20 \text{ M}\Omega</math> (X1A: <math>19.5 \text{ M}\Omega</math>, X0A: <math>0.5 \text{ M}\Omega</math>). Feedback resistor is grounded in the center when the oscillator is disabled</li> </ul>
C		<ul style="list-style-type: none"> <li>■ Mask ROM and EVA device: CMOS Hysteresis input pin</li> <li>■ Flash device: CMOS input pin</li> </ul>
E		<ul style="list-style-type: none"> <li>■ CMOS Hysteresis input pin</li> <li>■ Pull-up resistor value: approx. <math>50 \text{ k}\Omega</math></li> </ul>

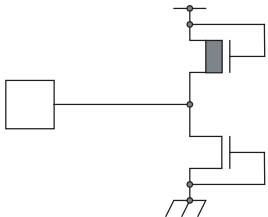
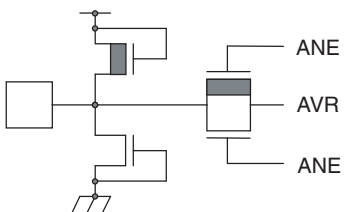
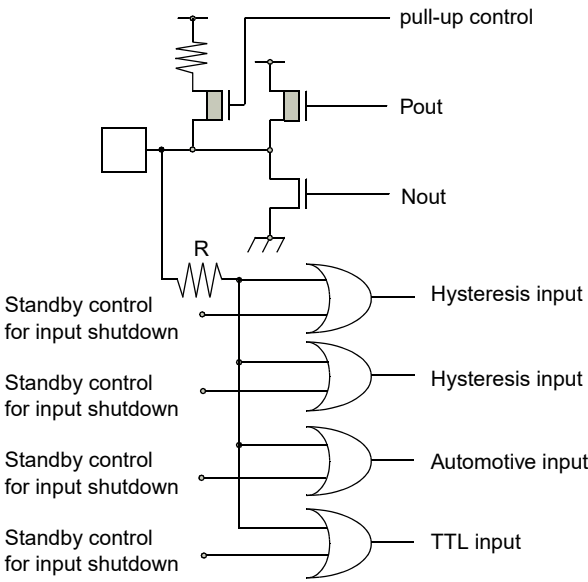
Type	Circuit	Remarks
F		<ul style="list-style-type: none"> <li>■ Power supply input protection circuit</li> </ul>
G		<ul style="list-style-type: none"> <li>■ A/D converter ref+ (AVRH) power supply input pin with protection circuit</li> <li>■ Flash devices do not have a protection circuit against VCC for pin AVRH</li> </ul>
H		<ul style="list-style-type: none"> <li>■ CMOS level output (programmable <math>I_{OL} = 5\text{ mA}</math>, <math>I_{OH} = -5\text{ mA}</math> and <math>I_{OL} = 2\text{ mA}</math>, <math>I_{OH} = -2\text{ mA}</math>)</li> <li>■ 2 different CMOS hysteresis inputs with input shutdown function</li> <li>■ Automotive input with input shutdown function</li> <li>■ TTL input with input shutdown function</li> <li>■ Programmable pull-up resistor: 50 kΩ approx.</li> </ul>

Type	Circuit	Remarks
I	<p>Pull-up control</p> <p>Pout</p> <p>Nout</p> <p>Standby control for input shutdown</p> <p>Hysteresis input</p> <p>Hysteresis input</p> <p>Automotive input</p> <p>TTL input</p> <p>Analog input</p> <p>R</p>	<ul style="list-style-type: none"> <li>■ CMOS level output (programmable <math>I_{OL} = 5\text{ mA}</math>, <math>I_{OH} = -5\text{ mA}</math> and <math>I_{OL} = 2\text{ mA}</math>, <math>I_{OH} = -2\text{ mA}</math>)</li> <li>■ 2 different CMOS hysteresis inputs with input shutdown function</li> <li>■ Automotive input with input shutdown function</li> <li>■ TTL input with input shutdown function.</li> <li>■ Programmable pull-up resistor: 50 kΩ approx.</li> <li>■ Analog input</li> </ul>
N	<p>pull-up control</p> <p>Pout</p> <p>Nout</p> <p>Standby control for input shutdown</p> <p>Hysteresis input</p> <p>Hysteresis input</p> <p>Automotive input</p> <p>TTL input</p> <p>R</p>	<ul style="list-style-type: none"> <li>■ CMOS level output (<math>I_{OL} = 3\text{ mA}</math>, <math>I_{OH} = -3\text{ mA}</math>)</li> <li>■ 2 different CMOS hysteresis inputs with input shutdown function</li> <li>■ Automotive input with input shutdown function</li> <li>■ TTL input with input shutdown function</li> <li>■ Programmable pull-up resistor: 50 kΩ approx.</li> </ul>

## 7. Memory Map

CY96V300B		CY96(F)32x	
FF:FFFF <sub>H</sub>	Emulation ROM		USER ROM / External Bus <sup>[4]</sup>
DE:0000 <sub>H</sub>			
	External Bus		External Bus
10:0000 <sub>H</sub>			
0F:E000 <sub>H</sub>	Boot-ROM		Boot-ROM
	Reserved		Reserved
0E:0000 <sub>H</sub>			
	External RAM		Reserved
02:0000 <sub>H</sub>			Reserved
	Internal RAM bank 1	RAMEND <sub>1</sub> <sup>[2]</sup> RAMSTART <sub>1</sub> <sup>[2]</sup>	Internal RAM bank 1
01:0000 <sub>H</sub>			Reserved
	ROM/RAM MIRROR		ROM/RAM MIRROR
00:8000 <sub>H</sub>			
	Internal RAM bank 0	RAMSTART <sub>0</sub> <sup>[2]</sup>	Internal RAM bank 0
			Reserved
RAM-START <sub>0</sub> <sup>[3]</sup>			External Bus
00:0C00 <sub>H</sub>	External Bus		
	Peripherals		Peripherals
00:0380 <sub>H</sub>			
00:0180 <sub>H</sub>	GPR <sup>[1]</sup>		GPR <sup>[1]</sup>
00:0100 <sub>H</sub>	DMA		DMA
00:00F0 <sub>H</sub>	External Bus		External Bus
00:0000 <sub>H</sub>	Peripheral		Peripheral

RAM availability depending on the device

External Bus end address<sup>[2]</sup>

[1]: Unused GPR banks can be used as RAM area  
 [2]: For External Bus end address and RAMSTART/END addresses, please refer to the table on the next page.  
 [3]: For EVA device, RAMSTART<sub>0</sub> depends on the configuration of the emulated device.  
 [4]: For details about USER ROM area, see the [User ROM Memory Map for Flash Devices](#) on the following pages.  
 The External Bus area and DMA area are only available if the device contains the corresponding resource.  
 The available RAM and ROM area depends on the device.

## 8. RAM Start/End and External Bus End Addresses

Devices	Bank 0 RAM Size	Bank 1 RAM Size	External Bus End Address	RAMSTART0	RAMSTART1	RAMEND1
CY96F326	12 KByte	-	00:51FF <sub>H</sub>	00:5240 <sub>H</sub>	-	-



## 9. User ROM Memory Map for Flash Devices

CY96F326			
Alternative mode CPU address	Flash memory mode address	Flash size 288 KByte	
FF:FFFF <sub>H</sub> FF:0000 <sub>H</sub>	3F:FFFF <sub>H</sub> 3F:0000 <sub>H</sub>	S39 - 64K	
FE:FFFF <sub>H</sub> FE:0000 <sub>H</sub>	3E:FFFF <sub>H</sub> 3E:0000 <sub>H</sub>	S38 - 64K	
FD:FFFF <sub>H</sub> FD:0000 <sub>H</sub>	3D:FFFF <sub>H</sub> 3D:0000 <sub>H</sub>	S37 - 64K	
FC:FFFF <sub>H</sub> FC:0000 <sub>H</sub>	3C:FFFF <sub>H</sub> 3C:0000 <sub>H</sub>	S36 - 64K	
FB:FFFF <sub>H</sub> FB:0000 <sub>H</sub>	3B:FFFF <sub>H</sub> 3B:0000 <sub>H</sub>	External bus	
FA:FFFF <sub>H</sub> FA:0000 <sub>H</sub>	3A:FFFF <sub>H</sub> 3A:0000 <sub>H</sub>		
F9:FFFF <sub>H</sub> F9:0000 <sub>H</sub>	39:FFFF <sub>H</sub> 39:0000 <sub>H</sub>		
F8:FFFF <sub>H</sub> F8:0000 <sub>H</sub>	38:FFFF <sub>H</sub> 38:0000 <sub>H</sub>		
F7:FFFF <sub>H</sub> F7:0000 <sub>H</sub>	37:FFFF <sub>H</sub> 37:0000 <sub>H</sub>		
F6:FFFF <sub>H</sub> F6:0000 <sub>H</sub>	36:FFFF <sub>H</sub> 36:0000 <sub>H</sub>		
F5:FFFF <sub>H</sub> F5:0000 <sub>H</sub>	35:FFFF <sub>H</sub> 35:0000 <sub>H</sub>		
F4:FFFF <sub>H</sub> F4:0000 <sub>H</sub>	34:FFFF <sub>H</sub> 34:0000 <sub>H</sub>		
F3:FFFF <sub>H</sub> F3:0000 <sub>H</sub>	33:FFFF <sub>H</sub> 33:0000 <sub>H</sub>		
F2:FFFF <sub>H</sub> F2:0000 <sub>H</sub>	32:FFFF <sub>H</sub> 32:0000 <sub>H</sub>		
F1:FFFF <sub>H</sub> F1:0000 <sub>H</sub>	31:FFFF <sub>H</sub> 31:0000 <sub>H</sub>		
F0:FFFF <sub>H</sub> F0:0000 <sub>H</sub>	30:FFFF <sub>H</sub> 30:0000 <sub>H</sub>		
E0:FFFF <sub>H</sub> E0:0000 <sub>H</sub>			
DF:FFFF <sub>H</sub> DF:8000 <sub>H</sub>			Reserved
DF:7FFF <sub>H</sub> DF:6000 <sub>H</sub>	1F:7FFF <sub>H</sub> 1F:6000 <sub>H</sub>		SA3 - 8K
DF:5FFF <sub>H</sub> DF:4000 <sub>H</sub>	1F:5FFF <sub>H</sub> 1F:4000 <sub>H</sub>		SA2 - 8K
DF:3FFF <sub>H</sub> DF:2000 <sub>H</sub>	1F:3FFF <sub>H</sub> 1F:2000 <sub>H</sub>	SA1 - 8K	
DF:1FFF <sub>H</sub> DF:0000 <sub>H</sub>	1F:1FFF <sub>H</sub> 1F:0000 <sub>H</sub>	SA0 - 8K <sup>[1]</sup>	
DE:FFFF <sub>H</sub> DE:0000 <sub>H</sub>		Reserved	

Flash A

Flash A

[1]: Sector SA0 contains the ROM Configuration Block RCBA at CPU address DF:0000<sub>H</sub> - DF:007F<sub>H</sub>

## 10. Serial Programming Communication Interface

Table 3: USART Channels for Flash Programming (MD[2:0] = 010, Serial Communication Mode)

CY96F32x		
Pin Number	USART Number	Normal Function
LQFP-80		
10	USART2	SIN2
11		SOT2
12		SCK2
42	USART3	SIN3
43		SOT3
44		SCK3
32	USART7	SIN7_R
31		SOT7_R
30		SCK7_R
35	USART8	SIN8_R
34		SOT8_R
33		SCK8_R

**Note:** If a Flash programmer and its software needs to use a handshaking pin, Cypress suggests to the tool vendor to support at least port P00\_1 on pin 31. If handshaking is used by the tool but P00\_1 is not available in customer's application, Cypress suggests to the customer to check the tool manual or to contact the tool vendor for alternative handshaking pins.

## 11. I/O Map

**Table 4: I/O Map CY96(F)32x**

Address	Register	Abbreviation 8-bit access	Abbreviation 16-bit access	Access
00000 <sub>H</sub>	I/O Port P00 - Port Data Register	PDR00		R/W
00001 <sub>H</sub>	I/O Port P01 - Port Data Register	PDR01		R/W
00002 <sub>H</sub>	I/O Port P02 - Port Data Register	PDR02		R/W
00003 <sub>H</sub>	I/O Port P03 - Port Data Register	PDR03		R/W
00004 <sub>H</sub>	I/O Port P04 - Port Data Register	PDR04		R/W
00005 <sub>H</sub>	I/O Port P05 - Port Data Register	PDR05		R/W
00006 <sub>H</sub>	I/O Port P06 - Port Data Register	PDR06		R/W
00007 <sub>H</sub>	I/O Port P07 - Port Data Register	PDR07		R/W
00008 <sub>H</sub>	Reserved			-
00009 <sub>H</sub>	I/O Port P09 - Port Data Register	PDR09		R/W
0000A <sub>H</sub> -0000C <sub>H</sub>	Reserved			-
0000D <sub>H</sub>	I/O Port P13 - Port Data Register	PDR13		R/W
0000E <sub>H</sub> -000010 <sub>H</sub>	Reserved			-
000011 <sub>H</sub>	I/O Port P17 - Port Data Register	PDR17		R/W
000012 <sub>H</sub> -000017 <sub>H</sub>	Reserved			-
000018 <sub>H</sub>	ADC0 - Control Status register Low	ADCSL	ADCS	R/W
000019 <sub>H</sub>	ADC0 - Control Status register High	ADCSH		R/W
00001A <sub>H</sub>	ADC0 - Data Register Low	ADCRL	ADCR	R
00001B <sub>H</sub>	ADC0 - Data Register High	ADCRH		R
00001C <sub>H</sub>	ADC0 - Setting Register		ADSR	R/W
00001D <sub>H</sub>	ADC0 - Setting Register			R/W
00001E <sub>H</sub>	ADC0 - Extended Configuration Register	ADECR		R/W
00001F <sub>H</sub>	Reserved			-
000020 <sub>H</sub>	FRT0 - Data register of free-running timer		TCDT0	R/W
000021 <sub>H</sub>	FRT0 - Data register of free-running timer			R/W
000022 <sub>H</sub>	FRT0 - Control status register of free-running timer Low	TCCSL0	TCCS0	R/W
000023 <sub>H</sub>	FRT0 - Control status register of free-running timer High	TCCSH0		R/W
000024 <sub>H</sub>	FRT1 - Data register of free-running timer		TCDT1	R/W
000025 <sub>H</sub>	FRT1 - Data register of free-running timer			R/W
000026 <sub>H</sub>	FRT1 - Control status register of free-running timer Low	TCCSL1	TCCS1	R/W
000027 <sub>H</sub>	FRT1 - Control status register of free-running timer High	TCCSH1		R/W

**Table 4: I/O Map CY96(F)32x**

Address	Register	Abbreviation 8-bit access	Abbreviation 16-bit access	Access
000028 <sub>H</sub> -000033 <sub>H</sub>	Reserved			-
000034 <sub>H</sub>	OCU4 - Output Compare Control Status	OCS4		R/W
000035 <sub>H</sub>	OCU5 - Output Compare Control Status	OCS5		R/W
000036 <sub>H</sub>	OCU4 - Compare Register		OCCP4	R/W
000037 <sub>H</sub>	OCU4 - Compare Register			R/W
000038 <sub>H</sub>	OCU5 - Compare Register		OCCP5	R/W
000039 <sub>H</sub>	OCU5 - Compare Register			R/W
00003A <sub>H</sub>	OCU6 - Output Compare Control Status	OCS6		R/W
00003B <sub>H</sub>	OCU7 - Output Compare Control Status	OCS7		R/W
00003C <sub>H</sub>	OCU6 - Compare Register		OCCP6	R/W
00003D <sub>H</sub>	OCU6 - Compare Register			R/W
00003E <sub>H</sub>	OCU7 - Compare Register		OCCP7	R/W
00003F <sub>H</sub>	OCU7 - Compare Register			R/W
000040 <sub>H</sub>	ICU0/ICU1 - Control Status Register	ICS01		R/W
000041 <sub>H</sub>	ICU0/ICU1 - Edge register	ICE01		R/W
000042 <sub>H</sub>	ICU0 - Capture Register Low	IPCPL0	IPCP0	R
000043 <sub>H</sub>	ICU0 - Capture Register High	IPCPL0		R
000044 <sub>H</sub>	ICU1 - Capture Register Low	IPCPL1	IPCP1	R
000045 <sub>H</sub>	ICU1 - Capture Register High	IPCPL1		R
000046 <sub>H</sub>	ICU2/ICU3 - Control Status Register	ICS23		R/W
000047 <sub>H</sub>	ICU2/ICU3 - Edge register	ICE23		R/W
000048 <sub>H</sub>	ICU2 - Capture Register Low	IPCPL2	IPCP2	R
000049 <sub>H</sub>	ICU2 - Capture Register High	IPCPL2		R
00004A <sub>H</sub>	ICU3 - Capture Register Low	IPCPL3	IPCP3	R
00004B <sub>H</sub>	ICU3 - Capture Register High	IPCPL3		R
00004C <sub>H</sub>	ICU4/ICU5 - Control Status Register	ICS45		R/W
00004D <sub>H</sub>	ICU4/ICU5 - Edge register	ICE45		R/W
00004E <sub>H</sub>	ICU4 - Capture Register Low	IPCPL4	IPCP4	R
00004F <sub>H</sub>	ICU4 - Capture Register High	IPCPL4		R
000050 <sub>H</sub>	ICU5 - Capture Register Low	IPCPL5	IPCP5	R
000051 <sub>H</sub>	ICU5 - Capture Register High	IPCPL5		R
000052 <sub>H</sub>	ICU6/ICU7 - Control Status Register	ICS67		R/W

**Table 4: I/O Map CY96(F)32x**

Address	Register	Abbreviation 8-bit access	Abbreviation 16-bit access	Access
000053 <sub>H</sub>	ICU6/ICU7 - Edge register	ICE67		R/W
000054 <sub>H</sub>	ICU6 - Capture Register Low	IPCPL6	IPCP6	R
000055 <sub>H</sub>	ICU6 - Capture Register High	IPCPH6		R
000056 <sub>H</sub>	ICU7 - Capture Register Low	IPCPL7	IPCP7	R
000057 <sub>H</sub>	ICU7 - Capture Register High	IPCPH7		R
000058 <sub>H</sub>	EXTINT0 - External Interrupt Enable Register	ENIR0		R/W
000059 <sub>H</sub>	EXTINT0 - External Interrupt Interrupt request Register	EIRR0		R/W
00005A <sub>H</sub>	EXTINT0 - External Interrupt Level Select Low	ELVRL0	ELVR0	R/W
00005B <sub>H</sub>	EXTINT0 - External Interrupt Level Select High	ELVRH0		R/W
00005C <sub>H</sub>	EXTINT1 - External Interrupt Enable Register	ENIR1		R/W
00005D <sub>H</sub>	EXTINT1 - External Interrupt Interrupt request Register	EIRR1		R/W
00005E <sub>H</sub>	EXTINT1 - External Interrupt Level Select Low	ELVRL1	ELVR1	R/W
00005F <sub>H</sub>	EXTINT1 - External Interrupt Level Select High	ELVRH1		R/W
000060 <sub>H</sub>	RLT0 - Timer Control Status Register Low	TMCSRL0	TMCSR0	R/W
000061 <sub>H</sub>	RLT0 - Timer Control Status Register High	TMCSRH0		R/W
000062 <sub>H</sub>	RLT0 - Reload Register - for writing		TMRLR0	W
000062 <sub>H</sub>	RLT0 - Reload Register - for reading		TMR0	R
000063 <sub>H</sub>	RLT0 - Reload Register - for writing			W
000063 <sub>H</sub>	RLT0 - Reload Register - for reading			R
000064 <sub>H</sub>	RLT1 - Timer Control Status Register Low	TMCSRL1	TMCSR1	R/W
000065 <sub>H</sub>	RLT1 - Timer Control Status Register High	TMCSRH1		R/W
000066 <sub>H</sub>	RLT1 - Reload Register - for writing		TMRLR1	W
000066 <sub>H</sub>	RLT1 - Reload Register - for reading		TMR1	R
000067 <sub>H</sub>	RLT1 - Reload Register - for writing			W
000067 <sub>H</sub>	RLT1 - Reload Register - for reading			R
000068 <sub>H</sub>	RLT2 - Timer Control Status Register Low	TMCSRL2	TMCSR2	R/W
000069 <sub>H</sub>	RLT2 - Timer Control Status Register High	TMCSRH2		R/W
00006A <sub>H</sub>	RLT2 - Reload Register - for writing		TMRLR2	W
00006A <sub>H</sub>	RLT2 - Reload Register - for reading		TMR2	R
00006B <sub>H</sub>	RLT2 - Reload Register - for writing			W
00006B <sub>H</sub>	RLT2 - Reload Register - for reading			R
00006C <sub>H</sub>	RLT3 - Timer Control Status Register Low	TMCSRL3	TMCSR3	R/W

**Table 4: I/O Map CY96(F)32x**

Address	Register	Abbreviation 8-bit access	Abbreviation 16-bit access	Access
00006D <sub>H</sub>	RLT3 - Timer Control Status Register High	TMCSRH3		R/W
00006E <sub>H</sub>	RLT3 - Reload Register - for writing		TMRLR3	W
00006E <sub>H</sub>	RLT3 - Reload Register - for reading		TMR3	R
00006F <sub>H</sub>	RLT3 - Reload Register - for writing			W
00006F <sub>H</sub>	RLT3 - Reload Register - for reading			R
000070 <sub>H</sub>	RLT6 - Timer Control Status Register Low (dedic. RLT for PPG)	TMCSRL6	TMCSR6	R/W
000071 <sub>H</sub>	RLT6 - Timer Control Status Register High (dedic. RLT for PPG)	TMCSRH6		R/W
000072 <sub>H</sub>	RLT6 - Reload Register (dedic. RLT for PPG) - for writing		TMRLR6	W
000072 <sub>H</sub>	RLT6 - Reload Register (dedic. RLT for PPG) - for reading		TMR6	R
000073 <sub>H</sub>	RLT6 - Reload Register (dedic. RLT for PPG) - for writing			W
000073 <sub>H</sub>	RLT6 - Reload Register (dedic. RLT for PPG) - for reading			R
000074 <sub>H</sub>	PPG3-PPG0 - General Control register 1 Low	GCN1L0	GCN10	R/W
000075 <sub>H</sub>	PPG3-PPG0 - General Control register 1 High	GCN1H0		R/W
000076 <sub>H</sub>	PPG3-PPG0 - General Control register 2 Low	GCN2L0	GCN20	R/W
000077 <sub>H</sub>	PPG3-PPG0 - General Control register 2 High	GCN2H0		R/W
000078 <sub>H</sub>	PPG0 - Timer register		PTMR0	R
000079 <sub>H</sub>	PPG0 - Timer register			R
00007A <sub>H</sub>	PPG0 - Period setting register		PCSR0	W
00007B <sub>H</sub>	PPG0 - Period setting register			W
00007C <sub>H</sub>	PPG0 - Duty cycle register		PDUT0	W
00007D <sub>H</sub>	PPG0 - Duty cycle register			W
00007E <sub>H</sub>	PPG0 - Control status register Low	PCNL0	PCN0	R/W
00007F <sub>H</sub>	PPG0 - Control status register High	PCNH0		R/W
000080 <sub>H</sub>	PPG1 - Timer register		PTMR1	R
000081 <sub>H</sub>	PPG1 - Timer register			R
000082 <sub>H</sub>	PPG1 - Period setting register		PCSR1	W
000083 <sub>H</sub>	PPG1 - Period setting register			W
000084 <sub>H</sub>	PPG1 - Duty cycle register		PDUT1	W
000085 <sub>H</sub>	PPG1 - Duty cycle register			W
000086 <sub>H</sub>	PPG1 - Control status register Low	PCNL1	PCN1	R/W
000087 <sub>H</sub>	PPG1 - Control status register High	PCNH1		R/W

**Table 4: I/O Map CY96(F)32x**

Address	Register	Abbreviation 8-bit access	Abbreviation 16-bit access	Access
000088 <sub>H</sub>	PPG2 - Timer register		PTMR2	R
000089 <sub>H</sub>	PPG2 - Timer register			R
00008A <sub>H</sub>	PPG2 - Period setting register		PCSR2	W
00008B <sub>H</sub>	PPG2 - Period setting register			W
00008C <sub>H</sub>	PPG2 - Duty cycle register		PDUT2	W
00008D <sub>H</sub>	PPG2 - Duty cycle register			W
00008E <sub>H</sub>	PPG2 - Control status register Low	PCNL2	PCN2	R/W
00008F <sub>H</sub>	PPG2 - Control status register High	PCNH2		R/W
000090 <sub>H</sub>	PPG3 - Timer register		PTMR3	R
000091 <sub>H</sub>	PPG3 - Timer register			R
000092 <sub>H</sub>	PPG3 - Period setting register		PCSR3	W
000093 <sub>H</sub>	PPG3 - Period setting register			W
000094 <sub>H</sub>	PPG3 - Duty cycle register		PDUT3	W
000095 <sub>H</sub>	PPG3 - Duty cycle register			W
000096 <sub>H</sub>	PPG3 - Control status register Low	PCNL3	PCN3	R/W
000097 <sub>H</sub>	PPG3 - Control status register High	PCNH3		R/W
000098 <sub>H</sub>	PPG7-PPG4 - General Control register 1 Low	GCN1L1	GCN11	R/W
000099 <sub>H</sub>	PPG7-PPG4 - General Control register 1 High	GCN1H1		R/W
00009A <sub>H</sub>	PPG7-PPG4 - General Control register 2 Low	GCN2L1	GCN21	R/W
00009B <sub>H</sub>	PPG7-PPG4 - General Control register 2 High	GCN2H1		R/W
00009C <sub>H</sub>	PPG4 - Timer register		PTMR4	R
00009D <sub>H</sub>	PPG4 - Timer register			R
00009E <sub>H</sub>	PPG4 - Period setting register		PCSR4	W
00009F <sub>H</sub>	PPG4 - Period setting register			W
0000A0 <sub>H</sub>	PPG4 - Duty cycle register		PDUT4	W
0000A1 <sub>H</sub>	PPG4 - Duty cycle register			W
0000A2 <sub>H</sub>	PPG4 - Control status register Low	PCNL4	PCN4	R/W
0000A3 <sub>H</sub>	PPG4 - Control status register High	PCNH4		R/W
0000A4 <sub>H</sub>	PPG5 - Timer register		PTMR5	R
0000A5 <sub>H</sub>	PPG5 - Timer register			R
0000A6 <sub>H</sub>	PPG5 - Period setting register		PCSR5	W
0000A7 <sub>H</sub>	PPG5 - Period setting register			W

**Table 4: I/O Map CY96(F)32x**

Address	Register	Abbreviation 8-bit access	Abbreviation 16-bit access	Access
0000A8 <sub>H</sub>	PPG5 - Duty cycle register		PDUT5	W
0000A9 <sub>H</sub>	PPG5 - Duty cycle register			W
0000AA <sub>H</sub>	PPG5 - Control status register Low	PCNL5	PCN5	R/W
0000AB <sub>H</sub>	PPG5 - Control status register High	PCNH5		R/W
0000AC <sub>H</sub>	I2C0 - Bus Status Register	IBSR0		R
0000AD <sub>H</sub>	I2C0 - Bus Control Register	IBCR0		R/W
0000AE <sub>H</sub>	I2C0 - Ten bit Slave address Register Low	ITBAL0	ITBA0	R/W
0000AF <sub>H</sub>	I2C0 - Ten bit Slave address Register High	ITBAH0		R/W
0000B0 <sub>H</sub>	I2C0 - Ten bit Address mask Register Low	ITMKL0	ITMK0	R/W
0000B1 <sub>H</sub>	I2C0 - Ten bit Address mask Register High	ITMKH0		R/W
0000B2 <sub>H</sub>	I2C0 - Seven bit Slave address Register	ISBA0		R/W
0000B3 <sub>H</sub>	I2C0 - Seven bit Address mask Register	ISMK0		R/W
0000B4 <sub>H</sub>	I2C0 - Data Register	IDAR0		R/W
0000B5 <sub>H</sub>	I2C0 - Clock Control Register	ICCR0		R/W
0000B6 <sub>H</sub> -0000D3 <sub>H</sub>	Reserved			-
0000D4 <sub>H</sub>	USART2 - Serial Mode Register	SMR2		R/W
0000D5 <sub>H</sub>	USART2 - Serial Control Register	SCR2		R/W
0000D6 <sub>H</sub>	USART2 - TX Register	TDR2		W
0000D6 <sub>H</sub>	USART2 - RX Register	RDR2		R
0000D7 <sub>H</sub>	USART2 - Serial Status	SSR2		R/W
0000D8 <sub>H</sub>	USART2 - Control/Com. Register	ECCR2		R/W
0000D9 <sub>H</sub>	USART2 - Ext. Status Register	ESCR2		R/W
0000DA <sub>H</sub>	USART2 - Baud Rate Generator Register Low	BGRL2	BGR2	R/W
0000DB <sub>H</sub>	USART2 - Baud Rate Generator Register High	BGRH2		R/W
0000DC <sub>H</sub>	USART2 - Extended Serial Interrupt Register	ESIR2		R/W
0000DD <sub>H</sub>	Reserved			-
0000DE <sub>H</sub>	USART3 - Serial Mode Register	SMR3		R/W
0000DF <sub>H</sub>	USART3 - Serial Control Register	SCR3		R/W
0000E0 <sub>H</sub>	USART3 - TX Register	TDR3		W
0000E0 <sub>H</sub>	USART3 - RX Register	RDR3		R
0000E1 <sub>H</sub>	USART3 - Serial Status	SSR3		R/W
0000E2 <sub>H</sub>	USART3 - Control/Com. Register	ECCR3		R/W



**Table 4: I/O Map CY96(F)32x**

Address	Register	Abbreviation 8-bit access	Abbreviation 16-bit access	Access
0000E3 <sub>H</sub>	USART3 - Ext. Status Register	ESCR3		R/W
0000E4 <sub>H</sub>	USART3 - Baud Rate Generator Register Low	BGRL3	BGR3	R/W
0000E5 <sub>H</sub>	USART3 - Baud Rate Generator Register High	BGRH3		R/W
0000E6 <sub>H</sub>	USART3 - Extended Serial Interrupt Register	ESIR3		R/W
0000E7 <sub>H</sub> -0000EF <sub>H</sub>	Reserved			-
0000F0 <sub>H</sub> -0000FF <sub>H</sub>	External Bus area	EXTBUS0		R/W
000100 <sub>H</sub>	DMA0 - Buffer address pointer low byte	BAPL0		R/W
000101 <sub>H</sub>	DMA0 - Buffer address pointer middle byte	BAPM0		R/W
000102 <sub>H</sub>	DMA0 - Buffer address pointer high byte	BAPH0		R/W
000103 <sub>H</sub>	DMA0 - DMA control register	DMACS0		R/W
000104 <sub>H</sub>	DMA0 - I/O register address pointer low byte	IOAL0	IOA0	R/W
000105 <sub>H</sub>	DMA0 - I/O register address pointer high byte	IOAH0		R/W
000106 <sub>H</sub>	DMA0 - Data counter low byte	DCTL0	DCT0	R/W
000107 <sub>H</sub>	DMA0 - Data counter high byte	DCTH0		R/W
000108 <sub>H</sub>	DMA1 - Buffer address pointer low byte	BAPL1		R/W
000109 <sub>H</sub>	DMA1 - Buffer address pointer middle byte	BAPM1		R/W
00010A <sub>H</sub>	DMA1 - Buffer address pointer high byte	BAPH1		R/W
00010B <sub>H</sub>	DMA1 - DMA control register	DMACS1		R/W
00010C <sub>H</sub>	DMA1 - I/O register address pointer low byte	IOAL1	IOA1	R/W
00010D <sub>H</sub>	DMA1 - I/O register address pointer high byte	IOAH1		R/W
00010E <sub>H</sub>	DMA1 - Data counter low byte	DCTL1	DCT1	R/W
00010F <sub>H</sub>	DMA1 - Data counter high byte	DCTH1		R/W
000110 <sub>H</sub>	DMA2 - Buffer address pointer low byte	BAPL2		R/W
000111 <sub>H</sub>	DMA2 - Buffer address pointer middle byte	BAPM2		R/W
000112 <sub>H</sub>	DMA2 - Buffer address pointer high byte	BAPH2		R/W
000113 <sub>H</sub>	DMA2 - DMA control register	DMACS2		R/W
000114 <sub>H</sub>	DMA2 - I/O register address pointer low byte	IOAL2	IOA2	R/W
000115 <sub>H</sub>	DMA2 - I/O register address pointer high byte	IOAH2		R/W
000116 <sub>H</sub>	DMA2 - Data counter low byte	DCTL2	DCT2	R/W
000117 <sub>H</sub>	DMA2 - Data counter high byte	DCTH2		R/W
000118 <sub>H</sub>	DMA3 - Buffer address pointer low byte	BAPL3		R/W
000119 <sub>H</sub>	DMA3 - Buffer address pointer middle byte	BAPM3		R/W

**Table 4: I/O Map CY96(F)32x**

Address	Register	Abbreviation 8-bit access	Abbreviation 16-bit access	Access
00011A <sub>H</sub>	DMA3 - Buffer address pointer high byte	BAPH3		R/W
00011B <sub>H</sub>	DMA3 - DMA control register	DMACS3		R/W
00011C <sub>H</sub>	DMA3 - I/O register address pointer low byte	IOAL3	IOA3	R/W
00011D <sub>H</sub>	DMA3 - I/O register address pointer high byte	IOAH3		R/W
00011E <sub>H</sub>	DMA3 - Data counter low byte	DCTL3	DCT3	R/W
00011F <sub>H</sub>	DMA3 - Data counter high byte	DCTH3		R/W
000120 <sub>H</sub> -00017F <sub>H</sub>	Reserved			-
000180 <sub>H</sub> -00037F <sub>H</sub>	CPU - General Purpose registers (RAM access)	GPR_RAM		R/W
000380 <sub>H</sub>	DMA0 - Interrupt select	DISEL0		R/W
000381 <sub>H</sub>	DMA1 - Interrupt select	DISEL1		R/W
000382 <sub>H</sub>	DMA2 - Interrupt select	DISEL2		R/W
000383 <sub>H</sub>	DMA3 - Interrupt select	DISEL3		R/W
000384 <sub>H</sub> -00038F <sub>H</sub>	Reserved			-
000390 <sub>H</sub>	DMA - Status register low byte	DSRL	DSR	R/W
000391 <sub>H</sub>	DMA - Status register high byte	DSRH		R/W
000392 <sub>H</sub>	DMA - Stop status register low byte	DSSRL	DSSR	R/W
000393 <sub>H</sub>	DMA - Stop status register high byte	DSSRH		R/W
000394 <sub>H</sub>	DMA - Enable register low byte	DERL	DER	R/W
000395 <sub>H</sub>	DMA - Enable register high byte	DERH		R/W
000396 <sub>H</sub> -00039F <sub>H</sub>	Reserved			-
0003A0 <sub>H</sub>	Interrupt level register	ILR	ICR	R/W
0003A1 <sub>H</sub>	Interrupt index register	IDX		R/W
0003A2 <sub>H</sub>	Interrupt vector table base register Low	TBRL	TBR	R/W
0003A3 <sub>H</sub>	Interrupt vector table base register High	TBRH		R/W
0003A4 <sub>H</sub>	Delayed Interrupt register	DIRR		R/W
0003A5 <sub>H</sub>	Non Maskable Interrupt register	NMI		R/W
0003A6 <sub>H</sub> -0003AB <sub>H</sub>	Reserved			-
0003AC <sub>H</sub>	EDSU communication interrupt selection Low	EDSU2L	EDSU2	R/W
0003AD <sub>H</sub>	EDSU communication interrupt selection High	EDSU2H		R/W
0003AE <sub>H</sub>	ROM mirror control register	ROMM		R/W
0003AF <sub>H</sub>	EDSU configuration register	EDSU		R/W
0003B0 <sub>H</sub>	Memory patch control/status register ch 0/1		PFCS0	R/W

**Table 4: I/O Map CY96(F)32x**

Address	Register	Abbreviation 8-bit access	Abbreviation 16-bit access	Access
0003B1 <sub>H</sub>	Memory patch control/status register ch 0/1			R/W
0003B2 <sub>H</sub>	Memory patch control/status register ch 2/3		PFCS1	R/W
0003B3 <sub>H</sub>	Memory patch control/status register ch 2/3			R/W
0003B4 <sub>H</sub>	Memory patch control/status register ch 4/5		PFCS2	R/W
0003B5 <sub>H</sub>	Memory patch control/status register ch 4/5			R/W
0003B6 <sub>H</sub>	Memory patch control/status register ch 6/7		PFCS3	R/W
0003B7 <sub>H</sub>	Memory patch control/status register ch 6/7			R/W
0003B8 <sub>H</sub>	Memory Patch function - Patch address 0 low	PFAL0		R/W
0003B9 <sub>H</sub>	Memory Patch function - Patch address 0 middle	PFAM0		R/W
0003BA <sub>H</sub>	Memory Patch function - Patch address 0 high	PFAH0		R/W
0003BB <sub>H</sub>	Memory Patch function - Patch address 1 low	PFAL1		R/W
0003BC <sub>H</sub>	Memory Patch function - Patch address 1 middle	PFAM1		R/W
0003BD <sub>H</sub>	Memory Patch function - Patch address 1 high	PFAH1		R/W
0003BE <sub>H</sub>	Memory Patch function - Patch address 2 low	PFAL2		R/W
0003BF <sub>H</sub>	Memory Patch function - Patch address 2 middle	PFAM2		R/W
0003C0 <sub>H</sub>	Memory Patch function - Patch address 2 high	PFAH2		R/W
0003C1 <sub>H</sub>	Memory Patch function - Patch address 3 low	PFAL3		R/W
0003C2 <sub>H</sub>	Memory Patch function - Patch address 3 middle	PFAM3		R/W
0003C3 <sub>H</sub>	Memory Patch function - Patch address 3 high	PFAH3		R/W
0003C4 <sub>H</sub>	Memory Patch function - Patch address 4 low	PFAL4		R/W
0003C5 <sub>H</sub>	Memory Patch function - Patch address 4 middle	PFAM4		R/W
0003C6 <sub>H</sub>	Memory Patch function - Patch address 4 high	PFAH4		R/W
0003C7 <sub>H</sub>	Memory Patch function - Patch address 5 low	PFAL5		R/W
0003C8 <sub>H</sub>	Memory Patch function - Patch address 5 middle	PFAM5		R/W
0003C9 <sub>H</sub>	Memory Patch function - Patch address 5 high	PFAH5		R/W
0003CA <sub>H</sub>	Memory Patch function - Patch address 6 low	PFAL6		R/W
0003CB <sub>H</sub>	Memory Patch function - Patch address 6 middle	PFAM6		R/W
0003CC <sub>H</sub>	Memory Patch function - Patch address 6 high	PFAH6		R/W
0003CD <sub>H</sub>	Memory Patch function - Patch address 7 low	PFAL7		R/W
0003CE <sub>H</sub>	Memory Patch function - Patch address 7 middle	PFAM7		R/W
0003CF <sub>H</sub>	Memory Patch function - Patch address 7 high	PFAH7		R/W
0003D0 <sub>H</sub>	Memory Patch function - Patch data 0 Low	PFDL0	PFD0	R/W

**Table 4: I/O Map CY96(F)32x**

Address	Register	Abbreviation 8-bit access	Abbreviation 16-bit access	Access
0003D1 <sub>H</sub>	Memory Patch function - Patch data 0 High	PFDH0		R/W
0003D2 <sub>H</sub>	Memory Patch function - Patch data 1 Low	PFDL1	PFD1	R/W
0003D3 <sub>H</sub>	Memory Patch function - Patch data 1 High	PFDH1		R/W
0003D4 <sub>H</sub>	Memory Patch function - Patch data 2 Low	PFDL2	PFD2	R/W
0003D5 <sub>H</sub>	Memory Patch function - Patch data 2 High	PFDH2		R/W
0003D6 <sub>H</sub>	Memory Patch function - Patch data 3 Low	PFDL3	PFD3	R/W
0003D7 <sub>H</sub>	Memory Patch function - Patch data 3 High	PFDH3		R/W
0003D8 <sub>H</sub>	Memory Patch function - Patch data 4 Low	PFDL4	PFD4	R/W
0003D9 <sub>H</sub>	Memory Patch function - Patch data 4 High	PFDH4		R/W
0003DA <sub>H</sub>	Memory Patch function - Patch data 5 Low	PFDL5	PFD5	R/W
0003DB <sub>H</sub>	Memory Patch function - Patch data 5 High	PFDH5		R/W
0003DC <sub>H</sub>	Memory Patch function - Patch data 6 Low	PFDL6	PFD6	R/W
0003DD <sub>H</sub>	Memory Patch function - Patch data 6 High	PFDH6		R/W
0003DE <sub>H</sub>	Memory Patch function - Patch data 7 Low	PFDL7	PFD7	R/W
0003DF <sub>H</sub>	Memory Patch function - Patch data 7 High	PFDH7		R/W
0003E0 <sub>H</sub> -0003F0 <sub>H</sub>	Reserved			-
0003F1 <sub>H</sub>	Memory Control Status Register A	MCSRA		R/W
0003F2 <sub>H</sub>	Memory Timing Configuration Register A Low	MTCRAL	MTCRA	R/W
0003F3 <sub>H</sub>	Memory Timing Configuration Register A High	MTCRAH		R/W
0003F4 <sub>H</sub> -0003F8 <sub>H</sub>	Reserved			-
0003F9 <sub>H</sub>	Flash Memory Write Control register 1	FMWC1		R/W
0003FA <sub>H</sub>	Flash Memory Write Control register 2	FMWC2		R/W
0003FB <sub>H</sub>	Flash Memory Write Control register 3	FMWC3		R/W
0003FC <sub>H</sub>	Flash Memory Write Control register 4	FMWC4		R/W
0003FD <sub>H</sub>	Flash Memory Write Control register 5	FMWC5		R/W
0003FE <sub>H</sub> -0003FF <sub>H</sub>	Reserved			-
000400 <sub>H</sub>	Standby Mode control register	SMCR		R/W
000401 <sub>H</sub>	Clock select register	CKSR		R/W
000402 <sub>H</sub>	Clock Stabilization select register	CKSSR		R/W
000403 <sub>H</sub>	Clock monitor register	CKMR		R
000404 <sub>H</sub>	Clock Frequency control register Low	CKFCRL	CKFCR	R/W
000405 <sub>H</sub>	Clock Frequency control register High	CKFCRH		R/W

**Table 4: I/O Map CY96(F)32x**

Address	Register	Abbreviation 8-bit access	Abbreviation 16-bit access	Access
000406 <sub>H</sub>	PLL Control register Low	PLLCRL	PLLCR	R/W
000407 <sub>H</sub>	PLL Control register High	PLLCRH		R/W
000408 <sub>H</sub>	RC clock timer control register	RCTCR		R/W
000409 <sub>H</sub>	Main clock timer control register	MCTCR		R/W
00040A <sub>H</sub>	Sub clock timer control register	SCTCR		R/W
00040B <sub>H</sub>	Reset cause and clock status register with clear function	RCCSRC		R
00040C <sub>H</sub>	Reset configuration register	RCR		R/W
00040D <sub>H</sub>	Reset cause and clock status register	RCCSR		R
00040E <sub>H</sub>	Watch dog timer configuration register	WDTC		R/W
00040F <sub>H</sub>	Watch dog timer clear pattern register	WDTCP		W
000410 <sub>H</sub> -000414 <sub>H</sub>	Reserved			-
000415 <sub>H</sub>	Clock output activation register	COAR		R/W
000416 <sub>H</sub>	Clock output configuration register 0	COCR0		R/W
000417 <sub>H</sub>	Clock output configuration register 1	COCR1		R/W
000418 <sub>H</sub>	Clock Modulator control register	CMCR		R/W
000419 <sub>H</sub>	Reserved			-
00041A <sub>H</sub>	Clock Modulator Parameter register Low	CMPRL	CMPR	R/W
00041B <sub>H</sub>	Clock Modulator Parameter register High	CMPRH		R/W
00041C <sub>H</sub> -00042B <sub>H</sub>	Reserved			-
00042C <sub>H</sub>	Voltage Regulator Control register	VRCR		R/W
00042D <sub>H</sub>	Clock Input and LVD Control Register	CILCR		R/W
00042E <sub>H</sub> -00042F <sub>H</sub>	Reserved			-
000430 <sub>H</sub>	I/O Port P00 - Data Direction Register	DDR00		R/W
000431 <sub>H</sub>	I/O Port P01 - Data Direction Register	DDR01		R/W
000432 <sub>H</sub>	I/O Port P02 - Data Direction Register	DDR02		R/W
000433 <sub>H</sub>	I/O Port P03 - Data Direction Register	DDR03		R/W
000434 <sub>H</sub>	I/O Port P04 - Data Direction Register	DDR04		R/W
000435 <sub>H</sub>	I/O Port P05 - Data Direction Register	DDR05		R/W
000436 <sub>H</sub>	I/O Port P06 - Data Direction Register	DDR06		R/W
000437 <sub>H</sub>	I/O Port P07 - Data Direction Register	DDR07		R/W
000438 <sub>H</sub>	Reserved			-
000439 <sub>H</sub>	I/O Port P09 - Data Direction Register	DDR09		R/W

**Table 4: I/O Map CY96(F)32x**

Address	Register	Abbreviation 8-bit access	Abbreviation 16-bit access	Access
00043A <sub>H</sub> -00043C <sub>H</sub>	Reserved			-
00043D <sub>H</sub>	I/O Port P13 - Data Direction Register	DDR13		R/W
00043E <sub>H</sub> -000440 <sub>H</sub>	Reserved			-
000441 <sub>H</sub>	I/O Port P17 - Data Direction Register	DDR17		R/W
000442 <sub>H</sub> -000443 <sub>H</sub>	Reserved			-
000444 <sub>H</sub>	I/O Port P00 - Port Input Enable Register	PIER00		R/W
000445 <sub>H</sub>	I/O Port P01 - Port Input Enable Register	PIER01		R/W
000446 <sub>H</sub>	I/O Port P02 - Port Input Enable Register	PIER02		R/W
000447 <sub>H</sub>	I/O Port P03 - Port Input Enable Register	PIER03		R/W
000448 <sub>H</sub>	I/O Port P04 - Port Input Enable Register	PIER04		R/W
000449 <sub>H</sub>	I/O Port P05 - Port Input Enable Register	PIER05		R/W
00044A <sub>H</sub>	I/O Port P06 - Port Input Enable Register	PIER06		R/W
00044B <sub>H</sub>	I/O Port P07 - Port Input Enable Register	PIER07		R/W
00044C <sub>H</sub>	Reserved			-
00044D <sub>H</sub>	I/O Port P09 - Port Input Enable Register	PIER09		R/W
00044E <sub>H</sub> -000450 <sub>H</sub>	Reserved			-
000451 <sub>H</sub>	I/O Port P13 - Port Input Enable Register	PIER13		R/W
000452 <sub>H</sub> -000454 <sub>H</sub>	Reserved			-
000455 <sub>H</sub>	I/O Port P17 - Port Input Enable Register	PIER17		R/W
000456 <sub>H</sub> -000457 <sub>H</sub>	Reserved			-
000458 <sub>H</sub>	I/O Port P00 - Port Input Level Register	PILR00		R/W
000459 <sub>H</sub>	I/O Port P01 - Port Input Level Register	PILR01		R/W
00045A <sub>H</sub>	I/O Port P02 - Port Input Level Register	PILR02		R/W
00045B <sub>H</sub>	I/O Port P03 - Port Input Level Register	PILR03		R/W
00045C <sub>H</sub>	I/O Port P04 - Port Input Level Register	PILR04		R/W
00045D <sub>H</sub>	I/O Port P05 - Port Input Level Register	PILR05		R/W
00045E <sub>H</sub>	I/O Port P06 - Port Input Level Register	PILR06		R/W
00045F <sub>H</sub>	I/O Port P07 - Port Input Level Register	PILR07		R/W
000460 <sub>H</sub>	Reserved			-
000461 <sub>H</sub>	I/O Port P09 - Port Input Level Register	PILR09		R/W
000462 <sub>H</sub> -000464 <sub>H</sub>	Reserved			-
000465 <sub>H</sub>	I/O Port P13 - Port Input Level Register	PILR13		R/W

**Table 4: I/O Map CY96(F)32x**

Address	Register	Abbreviation 8-bit access	Abbreviation 16-bit access	Access
000466 <sub>H</sub> -000468 <sub>H</sub>	Reserved			-
000469 <sub>H</sub>	I/O Port P17 - Port Input Level Register	PILR17		R/W
00046A <sub>H</sub> -00046B <sub>H</sub>	Reserved			-
00046C <sub>H</sub>	I/O Port P00 - Extended Port Input Level Register	EPILR00		R/W
00046D <sub>H</sub>	I/O Port P01 - Extended Port Input Level Register	EPILR01		R/W
00046E <sub>H</sub>	I/O Port P02 - Extended Port Input Level Register	EPILR02		R/W
00046F <sub>H</sub>	I/O Port P03 - Extended Port Input Level Register	EPILR03		R/W
000470 <sub>H</sub>	I/O Port P04 - Extended Port Input Level Register	EPILR04		R/W
000471 <sub>H</sub>	I/O Port P05 - Extended Port Input Level Register	EPILR05		R/W
000472 <sub>H</sub>	I/O Port P06 - Extended Port Input Level Register	EPILR06		R/W
000473 <sub>H</sub>	I/O Port P07 - Extended Port Input Level Register	EPILR07		R/W
000474 <sub>H</sub>	Reserved			-
000475 <sub>H</sub>	I/O Port P09 - Extended Port Input Level Register	EPILR09		R/W
000476 <sub>H</sub> -000478 <sub>H</sub>	Reserved			-
000479 <sub>H</sub>	I/O Port P13 - Extended Port Input Level Register	EPILR13		R/W
00047A <sub>H</sub> -00047C <sub>H</sub>	Reserved			-
00047D <sub>H</sub>	I/O Port P17 - Extended Port Input Level Register	EPILR17		R/W
00047E <sub>H</sub> -00047F <sub>H</sub>	Reserved			-
000480 <sub>H</sub>	I/O Port P00 - Port Output Drive Register	PODR00		R/W
000481 <sub>H</sub>	I/O Port P01 - Port Output Drive Register	PODR01		R/W
000482 <sub>H</sub>	I/O Port P02 - Port Output Drive Register	PODR02		R/W
000483 <sub>H</sub>	I/O Port P03 - Port Output Drive Register	PODR03		R/W
000484 <sub>H</sub>	I/O Port P04 - Port Output Drive Register	PODR04		R/W
000485 <sub>H</sub>	I/O Port P05 - Port Output Drive Register	PODR05		R/W
000486 <sub>H</sub>	I/O Port P06 - Port Output Drive Register	PODR06		R/W
000487 <sub>H</sub>	I/O Port P07 - Port Output Drive Register	PODR07		R/W
000488 <sub>H</sub>	Reserved			-
000489 <sub>H</sub>	I/O Port P09 - Port Output Drive Register	PODR09		R/W
00048A <sub>H</sub> -00048C <sub>H</sub>	Reserved			-
00048D <sub>H</sub>	I/O Port P13 - Port Output Drive Register	PODR13		R/W
00048E <sub>H</sub> -000490 <sub>H</sub>	Reserved			-
000491 <sub>H</sub>	I/O Port P17 - Port Output Drive Register	PODR17		R/W

**Table 4: I/O Map CY96(F)32x**

Address	Register	Abbreviation 8-bit access	Abbreviation 16-bit access	Access
000492 <sub>H</sub> -00049C <sub>H</sub>	Reserved			-
00049D <sub>H</sub>	I/O Port P09 - Port High Drive Register	PHDR09		R/W
00049E <sub>H</sub> -0004A7 <sub>H</sub>	Reserved			-
0004A8 <sub>H</sub>	I/O Port P00 - Pull-Up resistor Control Register	PUCR00		R/W
0004A9 <sub>H</sub>	I/O Port P01 - Pull-Up resistor Control Register	PUCR01		R/W
0004AA <sub>H</sub>	I/O Port P02 - Pull-Up resistor Control Register	PUCR02		R/W
0004AB <sub>H</sub>	I/O Port P03 - Pull-Up resistor Control Register	PUCR03		R/W
0004AC <sub>H</sub>	I/O Port P04 - Pull-Up resistor Control Register	PUCR04		R/W
0004AD <sub>H</sub>	I/O Port P05 - Pull-Up resistor Control Register	PUCR05		R/W
0004AE <sub>H</sub>	I/O Port P06 - Pull-Up resistor Control Register	PUCR06		R/W
0004AF <sub>H</sub>	I/O Port P07 - Pull-Up resistor Control Register	PUCR07		R/W
0004B0 <sub>H</sub>	Reserved			-
0004B1 <sub>H</sub>	I/O Port P09 - Pull-Up resistor Control Register	PUCR09		R/W
0004B2 <sub>H</sub> -0004B4 <sub>H</sub>	Reserved			-
0004B5 <sub>H</sub>	I/O Port P13 - Pull-Up resistor Control Register	PUCR13		R/W
0004B6 <sub>H</sub> -0004B8 <sub>H</sub>	Reserved			-
0004B9 <sub>H</sub>	I/O Port P17 - Pull-Up resistor Control Register	PUCR17		R/W
0004BA <sub>H</sub> -0004BB <sub>H</sub>	Reserved			-
0004BC <sub>H</sub>	I/O Port P00 - External Pin State Register	EPSR00		R
0004BD <sub>H</sub>	I/O Port P01 - External Pin State Register	EPSR01		R
0004BE <sub>H</sub>	I/O Port P02 - External Pin State Register	EPSR02		R
0004BF <sub>H</sub>	I/O Port P03 - External Pin State Register	EPSR03		R
0004C0 <sub>H</sub>	I/O Port P04 - External Pin State Register	EPSR04		R
0004C1 <sub>H</sub>	I/O Port P05 - External Pin State Register	EPSR05		R
0004C2 <sub>H</sub>	I/O Port P06 - External Pin State Register	EPSR06		R
0004C3 <sub>H</sub>	I/O Port P07 - External Pin State Register	EPSR07		R
0004C4 <sub>H</sub>	Reserved			-
0004C5 <sub>H</sub>	I/O Port P09 - External Pin State Register	EPSR09		R
0004C6 <sub>H</sub> -0004C8 <sub>H</sub>	Reserved			-
0004C9 <sub>H</sub>	I/O Port P13 - External Pin State Register	EPSR13		R
0004CA <sub>H</sub> -0004CC <sub>H</sub>	Reserved			-
0004CD <sub>H</sub>	I/O Port P17 - External Pin State Register	EPSR17		R



**Table 4: I/O Map CY96(F)32x**

Address	Register	Abbreviation 8-bit access	Abbreviation 16-bit access	Access
0004CE <sub>H</sub> -0004CF <sub>H</sub>	Reserved			-
0004D0 <sub>H</sub>	ADC analog input enable register 0	ADER0		R/W
0004D1 <sub>H</sub>	ADC analog input enable register 1	ADER1		R/W
0004D2 <sub>H</sub>	ADC analog input enable register 2	ADER2		R/W
0004D3 <sub>H</sub>	ADC analog input enable register 3	ADER3		R/W
0004D4 <sub>H</sub>	ADC analog input enable register 4	ADER4		R/W
0004D5 <sub>H</sub>	Reserved			-
0004D6 <sub>H</sub>	Peripheral Resource Relocation Register 0	PRRR0		R/W
0004D7 <sub>H</sub>	Peripheral Resource Relocation Register 1	PRRR1		R/W
0004D8 <sub>H</sub>	Peripheral Resource Relocation Register 2	PRRR2		R/W
0004D9 <sub>H</sub>	Peripheral Resource Relocation Register 3	PRRR3		R/W
0004DA <sub>H</sub>	Peripheral Resource Relocation Register 4	PRRR4		R/W
0004DB <sub>H</sub>	Peripheral Resource Relocation Register 5	PRRR5		R/W
0004DC <sub>H</sub>	Peripheral Resource Relocation Register 6	PRRR6		R/W
0004DD <sub>H</sub>	Peripheral Resource Relocation Register 7	PRRR7		R/W
0004DE <sub>H</sub>	Peripheral Resource Relocation Register 8	PRRR8		R/W
0004DF <sub>H</sub>	Peripheral Resource Relocation Register 9	PRRR9		R/W
0004E0 <sub>H</sub>	RTC - Sub Second Register L	WTBRL0	WTBR0	R/W
0004E1 <sub>H</sub>	RTC - Sub Second Register M	WTBRH0		R/W
0004E2 <sub>H</sub>	RTC - Sub-Second Register H	WTBR1		R/W
0004E3 <sub>H</sub>	RTC - Second Register	WTSR		R/W
0004E4 <sub>H</sub>	RTC - Minutes	WTMR		R/W
0004E5 <sub>H</sub>	RTC - Hour	WTHR		R/W
0004E6 <sub>H</sub>	RTC - Timer Control Extended Register	WTCER		R/W
0004E7 <sub>H</sub>	RTC - Clock select register	WTCKSR		R/W
0004E8 <sub>H</sub>	RTC - Timer Control Register Low	WTCRL	WTCR	R/W
0004E9 <sub>H</sub>	RTC - Timer Control Register High	WTCRH		R/W
0004EA <sub>H</sub>	CAL - Calibration unit Control register	CUCR		R/W
0004EB <sub>H</sub>	Reserved			-
0004EC <sub>H</sub>	CAL - Duration Timer Data Register Low	CUTDL	CUTD	R/W
0004ED <sub>H</sub>	CAL - Duration Timer Data Register High	CUTDH		R/W
0004EE <sub>H</sub>	CAL - Calibration Timer Register 2 Low	CUTR2L	CUTR2	R

**Table 4: I/O Map CY96(F)32x**

Address	Register	Abbreviation 8-bit access	Abbreviation 16-bit access	Access
0004EF <sub>H</sub>	CAL - Calibration Timer Register 2 High	CUTR2H		R
0004F0 <sub>H</sub>	CAL - Calibration Timer Register 1 Low	CUTR1L	CUTR1	R
0004F1 <sub>H</sub>	CAL - Calibration Timer Register 1 High	CUTR1H		R
0004F2 <sub>H</sub> -0004F9 <sub>H</sub>	Reserved			-
0004FA <sub>H</sub>	RLT - Timer input select (for Cascading)	TMISR		R/W
0004FB <sub>H</sub> -0004FF <sub>H</sub>	Reserved			-
000500 <sub>H</sub>	FRT2 - Data register of free-running timer		TCDT2	R/W
000501 <sub>H</sub>	FRT2 - Data register of free-running timer			R/W
000502 <sub>H</sub>	FRT2 - Control status register of free-running timer Low	TCCSL2	TCCS2	R/W
000503 <sub>H</sub>	FRT2 - Control status register of free-running timer High	TCCSH2		R/W
000504 <sub>H</sub>	FRT3 - Data register of free-running timer		TCDT3	R/W
000505 <sub>H</sub>	FRT3 - Data register of free-running timer			R/W
000506 <sub>H</sub>	FRT3 - Control status register of free-running timer Low	TCCSL3	TCCS3	R/W
000507 <sub>H</sub>	FRT3 - Control status register of free-running timer High	TCCSH3		R/W
000508 <sub>H</sub> -00050D <sub>H</sub>	Reserved			-
00050E <sub>H</sub>	OCU10 - Output Compare Control Status	OCS10		R/W
00050F <sub>H</sub>	OCU11 - Output Compare Control Status	OCS11		R/W
000510 <sub>H</sub>	OCU10 - Compare Register		OCCP10	R/W
000511 <sub>H</sub>	OCU10 - Compare Register			R/W
000512 <sub>H</sub>	OCU11 - Compare Register		OCCP11	R/W
000513 <sub>H</sub>	OCU11 - Compare Register			R/W
000514 <sub>H</sub>	ICU8/ICU9 - Control Status Register	ICS89		R/W
000515 <sub>H</sub>	ICU8/ICU9 - Edge Register	ICE89		R/W
000516 <sub>H</sub>	ICU8 - Capture Register Low	IPCPL8	IPCP8	R
000517 <sub>H</sub>	ICU8 - Capture Register High	IPCPH8		R
000518 <sub>H</sub>	ICU9 - Capture Register Low	IPCPL9	IPCP9	R
000519 <sub>H</sub>	ICU9 - Capture Register High	IPCPH9		R
00051A <sub>H</sub>	ICU10/ICU11 - Control Status Register	ICS1011		R/W
00051B <sub>H</sub>	ICU10/ICU11 - Edge Register	ICE1011		R/W
00051C <sub>H</sub>	ICU10 - Capture Register Low	IPCPL10	IPCP10	R
00051D <sub>H</sub>	ICU10 - Capture Register High	IPCPH10		R
00051E <sub>H</sub>	ICU11 - Capture Register Low	IPCPL11	IPCP11	R

**Table 4: I/O Map CY96(F)32x**

Address	Register	Abbreviation 8-bit access	Abbreviation 16-bit access	Access
00051F <sub>H</sub>	ICU11 - Capture Register High	IPCPH11		R
000520 <sub>H</sub> -00053D <sub>H</sub>	Reserved			-
00053E <sub>H</sub>	USART7 - Serial Mode Register	SMR7		R/W
00053F <sub>H</sub>	USART7 - Serial Control Register	SCR7		R/W
000540 <sub>H</sub>	USART7 - Serial TX Register	TDR7		W
000540 <sub>H</sub>	USART7 - Serial RX Register	RDR7		R
000541 <sub>H</sub>	USART7 - Serial Status Register	SSR7		R/W
000542 <sub>H</sub>	USART7 - Ext. Control/Com. Register	ECCR7		R/W
000543 <sub>H</sub>	USART7 - Ext. Status Com. Register	ESCR7		R/W
000544 <sub>H</sub>	USART7 - Baud Rate Generator Register Low	BGRL7	BGR7	R/W
000545 <sub>H</sub>	USART7 - Baud Rate Generator Register High	BGRH7		R/W
000546 <sub>H</sub>	USART7 - Extended Serial Interrupt Register	ESIR7		R/W
000547 <sub>H</sub>	Reserved			-
000548 <sub>H</sub>	USART8 - Serial Mode Register	SMR8		R/W
000549 <sub>H</sub>	USART8 - Serial Control Register	SCR8		R/W
00054A <sub>H</sub>	USART8 - Serial TX Register	TDR8		W
00054A <sub>H</sub>	USART8 - Serial RX Register	RDR8		R
00054B <sub>H</sub>	USART8 - Serial Status Register	SSR8		R/W
00054C <sub>H</sub>	USART8 - Ext. Control/Com. Register	ECCR8		R/W
00054D <sub>H</sub>	USART8 - Ext. Status Com. Register	ESCR8		R/W
00054E <sub>H</sub>	USART8 - Baud Rate Generator Register Low	BGRL8	BGR8	R/W
00054F <sub>H</sub>	USART8 - Baud Rate Generator Register High	BGRH8		R/W
000550 <sub>H</sub>	USART8 - Extended Serial Interrupt Register	ESIR8		R/W
000551 <sub>H</sub> -000563 <sub>H</sub>	Reserved			-
000564 <sub>H</sub>	PPG6 - Timer register		PTMR6	R
000565 <sub>H</sub>	PPG6 - Timer register			R
000566 <sub>H</sub>	PPG6 - Period setting register		PCSR6	W
000567 <sub>H</sub>	PPG6 - Period setting register			W
000568 <sub>H</sub>	PPG6 - Duty cycle register		PDUT6	W
000569 <sub>H</sub>	PPG6 - Duty cycle register			W
00056A <sub>H</sub>	PPG6 - Control status register Low	PCNL6	PCN6	R/W
00056B <sub>H</sub>	PPG6 - Control status register High	PCNH6		R/W

**Table 4: I/O Map CY96(F)32x**

Address	Register	Abbreviation 8-bit access	Abbreviation 16-bit access	Access
00056C <sub>H</sub>	PPG7 - Timer register		PTMR7	R
00056D <sub>H</sub>	PPG7 - Timer register			R
00056E <sub>H</sub>	PPG7 - Period setting register		PCSR7	W
00056F <sub>H</sub>	PPG7 - Period setting register			W
000570 <sub>H</sub>	PPG7 - Duty cycle register		PDUT7	W
000571 <sub>H</sub>	PPG7 - Duty cycle register			W
000572 <sub>H</sub>	PPG7 - Control status register Low	PCNL7	PCN7	R/W
000573 <sub>H</sub>	PPG7 - Control status register High	PCNH7		R/W
000574 <sub>H</sub>	PPG11-PPG8 - General Control register 1 Low	GCN1L2	GCN12	R/W
000575 <sub>H</sub>	PPG11-PPG8 - General Control register 1 High	GCN1H2		R/W
000576 <sub>H</sub>	PPG11-PPG8 - General Control register 2 Low	GCN2L2	GCN22	R/W
000577 <sub>H</sub>	PPG11-PPG8 - General Control register 2 High	GCN2H2		R/W
000578 <sub>H</sub>	PPG8 - Timer register		PTMR8	R
000579 <sub>H</sub>	PPG8 - Timer register			R
00057A <sub>H</sub>	PPG8 - Period setting register		PCSR8	W
00057B <sub>H</sub>	PPG8 - Period setting register			W
00057C <sub>H</sub>	PPG8 - Duty cycle register		PDUT8	W
00057D <sub>H</sub>	PPG8 - Duty cycle register			W
00057E <sub>H</sub>	PPG8 - Control status register Low	PCNL8	PCN8	R/W
00057F <sub>H</sub>	PPG8 - Control status register High	PCNH8		R/W
000580 <sub>H</sub>	PPG9 - Timer register		PTMR9	R
000581 <sub>H</sub>	PPG9 - Timer register			R
000582 <sub>H</sub>	PPG9 - Period setting register		PCSR9	W
000583 <sub>H</sub>	PPG9 - Period setting register			W
000584 <sub>H</sub>	PPG9 - Duty cycle register		PDUT9	W
000585 <sub>H</sub>	PPG9 - Duty cycle register			W
000586 <sub>H</sub>	PPG9 - Control status register Low	PCNL9	PCN9	R/W
000587 <sub>H</sub>	PPG9 - Control status register High	PCNH9		R/W
000588 <sub>H</sub>	PPG10 - Timer register		PTMR10	R
000589 <sub>H</sub>	PPG10 - Timer register			R
00058A <sub>H</sub>	PPG10 - Period setting register		PCSR10	W
00058B <sub>H</sub>	PPG10 - Period setting register			W

**Table 4: I/O Map CY96(F)32x**

Address	Register	Abbreviation 8-bit access	Abbreviation 16-bit access	Access
00058C <sub>H</sub>	PPG10 - Duty cycle register		PDUT10	W
00058D <sub>H</sub>	PPG10 - Duty cycle register			W
00058E <sub>H</sub>	PPG10 - Control status register Low	PCNL10	PCN10	R/W
00058F <sub>H</sub>	PPG10 - Control status register High	PCNH10		R/W
000590 <sub>H</sub>	PPG11 - Timer register		PTMR11	R
000591 <sub>H</sub>	PPG11 - Timer register			R
000592 <sub>H</sub>	PPG11 - Period setting register		PCSR11	W
000593 <sub>H</sub>	PPG11 - Period setting register			W
000594 <sub>H</sub>	PPG11 - Duty cycle register		PDUT11	W
000595 <sub>H</sub>	PPG11 - Duty cycle register			W
000596 <sub>H</sub>	PPG11 - Control status register Low	PCNL11	PCN11	R/W
000597 <sub>H</sub>	PPG11 - Control status register High	PCNH11		R/W
000598 <sub>H</sub>	PPG15-PPG12 - General Control register 1 Low	GCN1L3	GCN13	R/W
000599 <sub>H</sub>	PPG15-PPG12 - General Control register 1 High	GCN1H3		R/W
00059A <sub>H</sub>	PPG15-PPG12 - General Control register 2 Low	GCN2L3	GCN23	R/W
00059B <sub>H</sub>	PPG15-PPG12 - General Control register 2 High	GCN2H3		R/W
00059C <sub>H</sub>	PPG12 - Timer register		PTMR12	R
00059D <sub>H</sub>	PPG12 - Timer register			R
00059E <sub>H</sub>	PPG12 - Period setting register		PCSR12	W
00059F <sub>H</sub>	PPG12 - Period setting register			W
0005A0 <sub>H</sub>	PPG12 - Duty cycle register		PDUT12	W
0005A1 <sub>H</sub>	PPG12 - Duty cycle register			W
0005A2 <sub>H</sub>	PPG12 - Control status register Low	PCNL12	PCN12	R/W
0005A3 <sub>H</sub>	PPG12 - Control status register High	PCNH12		R/W
0005A4 <sub>H</sub>	PPG13 - Timer register		PTMR13	R
0005A5 <sub>H</sub>	PPG13 - Timer register			R
0005A6 <sub>H</sub>	PPG13 - Period setting register		PCSR13	W
0005A7 <sub>H</sub>	PPG13 - Period setting register			W
0005A8 <sub>H</sub>	PPG13 - Duty cycle register		PDUT13	W
0005A9 <sub>H</sub>	PPG13 - Duty cycle register			W
0005AA <sub>H</sub>	PPG13 - Control status register Low	PCNL13	PCN13	R/W
0005AB <sub>H</sub>	PPG13 - Control status register High	PCNH13		R/W

**Table 4: I/O Map CY96(F)32x**

Address	Register	Abbreviation 8-bit access	Abbreviation 16-bit access	Access
0005AC <sub>H</sub>	PPG14 - Timer register		PTMR14	R
0005AD <sub>H</sub>	PPG14 - Timer register			R
0005AE <sub>H</sub>	PPG14 - Period setting register		PCSR14	W
0005AF <sub>H</sub>	PPG14 - Period setting register			W
0005B0 <sub>H</sub>	PPG14 - Duty cycle register		PDUT14	W
0005B1 <sub>H</sub>	PPG14 - Duty cycle register			W
0005B2 <sub>H</sub>	PPG14 - Control status register Low	PCNL14	PCN14	R/W
0005B3 <sub>H</sub>	PPG14 - Control status register High	PCNH14		R/W
0005B4 <sub>H</sub>	PPG15 - Timer register		PTMR15	R
0005B5 <sub>H</sub>	PPG15 - Timer register			R
0005B6 <sub>H</sub>	PPG15 - Period setting register		PCSR15	W
0005B7 <sub>H</sub>	PPG15 - Period setting register			W
0005B8 <sub>H</sub>	PPG15 - Duty cycle register		PDUT15	W
0005B9 <sub>H</sub>	PPG15 - Duty cycle register			W
0005BA <sub>H</sub>	PPG15 - Control status register Low	PCNL15	PCN15	R/W
0005BB <sub>H</sub>	PPG15 - Control status register High	PCNH15		R/W
0005BC <sub>H</sub>	PPG19-PPG16 - General Control register 1 Low	GCN1L4	GCN14	R/W
0005BD <sub>H</sub>	PPG19-PPG16 - General Control register 1 High	GCN1H4		R/W
0005BE <sub>H</sub>	PPG19-PPG16 - General Control register 2 Low	GCN2L4	GCN24	R/W
0005BF <sub>H</sub>	PPG19-PPG16 - General Control register 2 High	GCN2H4		R/W
0005C0 <sub>H</sub>	PPG16 - Timer register		PTMR16	R
0005C1 <sub>H</sub>	PPG16 - Timer register			R
0005C2 <sub>H</sub>	PPG16 - Period setting register		PCSR16	W
0005C3 <sub>H</sub>	PPG16 - Period setting register			W
0005C4 <sub>H</sub>	PPG16 - Duty cycle register		PDUT16	W
0005C5 <sub>H</sub>	PPG16 - Duty cycle register			W
0005C6 <sub>H</sub>	PPG16 - Control status register Low	PCNL16	PCN16	R/W
0005C7 <sub>H</sub>	PPG16 - Control status register High	PCNH16		R/W
0005C8 <sub>H</sub>	PPG17 - Timer register		PTMR17	R
0005C9 <sub>H</sub>	PPG17 - Timer register			R
0005CA <sub>H</sub>	PPG17 - Period setting register		PCSR17	W
0005CB <sub>H</sub>	PPG17 - Period setting register			W

**Table 4: I/O Map CY96(F)32x**

Address	Register	Abbreviation 8-bit access	Abbreviation 16-bit access	Access
0005CC <sub>H</sub>	PPG17 - Duty cycle register		PDUT17	W
0005CD <sub>H</sub>	PPG17 - Duty cycle register			W
0005CE <sub>H</sub>	PPG17 - Control status register Low	PCNL17	PCN17	R/W
0005CF <sub>H</sub>	PPG17 - Control status register High	PCNH17		R/W
0005D0 <sub>H</sub>	PPG18 - Timer register		PTMR18	R
0005D1 <sub>H</sub>	PPG18 - Timer register			R
0005D2 <sub>H</sub>	PPG18 - Period setting register		PCSR18	W
0005D3 <sub>H</sub>	PPG18 - Period setting register			W
0005D4 <sub>H</sub>	PPG18 - Duty cycle register		PDUT18	W
0005D5 <sub>H</sub>	PPG18 - Duty cycle register			W
0005D6 <sub>H</sub>	PPG18 - Control status register Low	PCNL18	PCN18	R/W
0005D7 <sub>H</sub>	PPG18 - Control status register High	PCNH18		R/W
0005D8 <sub>H</sub>	PPG19 - Timer register		PTMR19	R
0005D9 <sub>H</sub>	PPG19 - Timer register			R
0005DA <sub>H</sub>	PPG19 - Period setting register		PCSR19	W
0005DB <sub>H</sub>	PPG19 - Period setting register			W
0005DC <sub>H</sub>	PPG19 - Duty cycle register		PDUT19	W
0005DD <sub>H</sub>	PPG19 - Duty cycle register			W
0005DE <sub>H</sub>	PPG19 - Control status register Low	PCNL19	PCN19	R/W
0005DF <sub>H</sub>	PPG19 - Control status register High	PCNH19		R/W
0005E0 <sub>H</sub> -00065F <sub>H</sub>	Reserved			-
000660 <sub>H</sub>	Peripheral Resource Relocation Register 10	PRRR10		R/W
000661 <sub>H</sub>	Peripheral Resource Relocation Register 11	PRRR11		R/W
000662 <sub>H</sub>	Peripheral Resource Relocation Register 12	PRRR12		R/W
000663 <sub>H</sub>	Peripheral Resource Relocation Register 13	PRRR13		W
000664 <sub>H</sub> -0006DF <sub>H</sub>	Reserved			-
0006E0 <sub>H</sub>	External Bus - Area configuration register 0 Low	EACL0	EAC0	R/W
0006E1 <sub>H</sub>	External Bus - Area configuration register 0 High	EACH0		R/W
0006E2 <sub>H</sub>	External Bus - Area configuration register 1 Low	EACL1	EAC1	R/W
0006E3 <sub>H</sub>	External Bus - Area configuration register 1 High	EACH1		R/W
0006E4 <sub>H</sub>	External Bus - Area configuration register 2 Low	EACL2	EAC2	R/W
0006E5 <sub>H</sub>	External Bus - Area configuration register 2 High	EACH2		R/W

**Table 4: I/O Map CY96(F)32x**

Address	Register	Abbreviation 8-bit access	Abbreviation 16-bit access	Access
0006E6 <sub>H</sub>	External Bus - Area configuration register 3 Low	EACL3	EAC3	R/W
0006E7 <sub>H</sub>	External Bus - Area configuration register 3 High	EACH3		R/W
0006E8 <sub>H</sub>	External Bus - Area configuration register 4 Low	EACL4	EAC4	R/W
0006E9 <sub>H</sub>	External Bus - Area configuration register 4 High	EACH4		R/W
0006EA <sub>H</sub>	External Bus - Area configuration register 5 Low	EACL5	EAC5	R/W
0006EB <sub>H</sub>	External Bus - Area configuration register 5 High	EACH5		R/W
0006EC <sub>H</sub>	External Bus - Area select register 2	EAS2		R/W
0006ED <sub>H</sub>	External Bus - Area select register 3	EAS3		R/W
0006EE <sub>H</sub>	External Bus - Area select register 4	EAS4		R/W
0006EF <sub>H</sub>	External Bus - Area select register 5	EAS5		R/W
0006F0 <sub>H</sub>	External Bus - Mode register	EBM		R/W
0006F1 <sub>H</sub>	External Bus - Clock and Function register	EBCF		R/W
0006F2 <sub>H</sub>	External Bus - Address output enable register 0	EBAE0		R/W
0006F3 <sub>H</sub>	External Bus - Address output enable register 1	EBAE1		R/W
0006F4 <sub>H</sub>	External Bus - Address output enable register 2	EBAE2		R/W
0006F5 <sub>H</sub>	External Bus - Control signal register	EBCS		R/W
0006F6 <sub>H</sub> -0007FF <sub>H</sub>	Reserved			-
000800 <sub>H</sub>	CAN1 - Control register Low	CTRLRL1	CTRLR1	R/W
000801 <sub>H</sub>	CAN1 - Control register High (reserved)	CTRLRH1		R
000802 <sub>H</sub>	CAN1 - Status register Low	STATRL1	STATR1	R/W
000803 <sub>H</sub>	CAN1 - Status register High (reserved)	STATRH1		R
000804 <sub>H</sub>	CAN1 - Error Counter Low (Transmit)	ERRCNTL1	ERRCNT1	R
000805 <sub>H</sub>	CAN1 - Error Counter High (Receive)	ERRCNTH1		R
000806 <sub>H</sub>	CAN1 - Bit Timing Register Low	BTRL1	BTR1	R/W
000807 <sub>H</sub>	CAN1 - Bit Timing Register High	BTRH1		R/W
000808 <sub>H</sub>	CAN1 - Interrupt Register Low	INTRL1	INTR1	R
000809 <sub>H</sub>	CAN1 - Interrupt Register High	INTRH1		R
00080A <sub>H</sub>	CAN1 - Test Register Low	TESTRL1	TESTR1	R/W
00080B <sub>H</sub>	CAN1 - Test Register High (reserved)	TESTRH1		R
00080C <sub>H</sub>	CAN1 - BRP Extension register Low	BRPERL1	BRPER1	R/W
00080D <sub>H</sub>	CAN1 - BRP Extension register High (reserved)	BRPERH1		R
00080E <sub>H</sub> -00080F <sub>H</sub>	Reserved			-



**Table 4: I/O Map CY96(F)32x**

Address	Register	Abbreviation 8-bit access	Abbreviation 16-bit access	Access
000810 <sub>H</sub>	CAN1 - IF1 Command request register Low	IF1CREQL1	IF1CREQ1	R/W
000811 <sub>H</sub>	CAN1 - IF1 Command request register High	IF1CREQH1		R/W
000812 <sub>H</sub>	CAN1 - IF1 Command Mask register Low	IF1CMSKL1	IF1CMSK1	R/W
000813 <sub>H</sub>	CAN1 - IF1 Command Mask register High (reserved)	IF1CMSKH1		R
000814 <sub>H</sub>	CAN1 - IF1 Mask 1 Register Low	IF1MSK1L1	IF1MSK11	R/W
000815 <sub>H</sub>	CAN1 - IF1 Mask 1 Register High	IF1MSK1H1		R/W
000816 <sub>H</sub>	CAN1 - IF1 Mask 2 Register Low	IF1MSK2L1	IF1MSK21	R/W
000817 <sub>H</sub>	CAN1 - IF1 Mask 2 Register High	IF1MSK2H1		R/W
000818 <sub>H</sub>	CAN1 - IF1 Arbitration 1 Register Low	IF1ARB1L1	IF1ARB11	R/W
000819 <sub>H</sub>	CAN1 - IF1 Arbitration 1 Register High	IF1ARB1H1		R/W
00081A <sub>H</sub>	CAN1 - IF1 Arbitration 2 Register Low	IF1ARB2L1	IF1ARB21	R/W
00081B <sub>H</sub>	CAN1 - IF1 Arbitration 2 Register High	IF1ARB2H1		R/W
00081C <sub>H</sub>	CAN1 - IF1 Message Control Register Low	IF1MCTRL1	IF1MCTR1	R/W
00081D <sub>H</sub>	CAN1 - IF1 Message Control Register High	IF1MCTRH1		R/W
00081E <sub>H</sub>	CAN1 - IF1 Data A1 Low	IF1DTA1L1	IF1DTA11	R/W
00081F <sub>H</sub>	CAN1 - IF1 Data A1 High	IF1DTA1H1		R/W
000820 <sub>H</sub>	CAN1 - IF1 Data A2 Low	IF1DTA2L1	IF1DTA21	R/W
000821 <sub>H</sub>	CAN1 - IF1 Data A2 High	IF1DTA2H1		R/W
000822 <sub>H</sub>	CAN1 - IF1 Data B1 Low	IF1DTB1L1	IF1DTB11	R/W
000823 <sub>H</sub>	CAN1 - IF1 Data B1 High	IF1DTB1H1		R/W
000824 <sub>H</sub>	CAN1 - IF1 Data B2 Low	IF1DTB2L1	IF1DTB21	R/W
000825 <sub>H</sub>	CAN1 - IF1 Data B2 High	IF1DTB2H1		R/W
000826 <sub>H</sub> -00083F <sub>H</sub>	Reserved			-
000840 <sub>H</sub>	CAN1 - IF2 Command request register Low	IF2CREQL1	IF2CREQ1	R/W
000841 <sub>H</sub>	CAN1 - IF2 Command request register High	IF2CREQH1		R/W
000842 <sub>H</sub>	CAN1 - IF2 Command Mask register Low	IF2CMSKL1	IF2CMSK1	R/W
000843 <sub>H</sub>	CAN1 - IF2 Command Mask register High (reserved)	IF2CMSKH1		R
000844 <sub>H</sub>	CAN1 - IF2 Mask 1 Register Low	IF2MSK1L1	IF2MSK11	R/W
000845 <sub>H</sub>	CAN1 - IF2 Mask 1 Register High	IF2MSK1H1		R/W
000846 <sub>H</sub>	CAN1 - IF2 Mask 2 Register Low	IF2MSK2L1	IF2MSK21	R/W
000847 <sub>H</sub>	CAN1 - IF2 Mask 2 Register High	IF2MSK2H1		R/W
000848 <sub>H</sub>	CAN1 - IF2 Arbitration 1 Register Low	IF2ARB1L1	IF2ARB11	R/W

**Table 4: I/O Map CY96(F)32x**

Address	Register	Abbreviation 8-bit access	Abbreviation 16-bit access	Access
000849 <sub>H</sub>	CAN1 - IF2 Arbitration 1 Register High	IF2ARB1H1		R/W
00084A <sub>H</sub>	CAN1 - IF2 Arbitration 2 Register Low	IF2ARB2L1	IF2ARB21	R/W
00084B <sub>H</sub>	CAN1 - IF2 Arbitration 2 Register High	IF2ARB2H1		R/W
00084C <sub>H</sub>	CAN1 - IF2 Message Control Register Low	IF2MCTRL1	IF2MCTR1	R/W
00084D <sub>H</sub>	CAN1 - IF2 Message Control Register High	IF2MCTRH1		R/W
00084E <sub>H</sub>	CAN1 - IF2 Data A1 Low	IF2DTA1L1	IF2DTA11	R/W
00084F <sub>H</sub>	CAN1 - IF2 Data A1 High	IF2DTA1H1		R/W
000850 <sub>H</sub>	CAN1 - IF2 Data A2 Low	IF2DTA2L1	IF2DTA21	R/W
000851 <sub>H</sub>	CAN1 - IF2 Data A2 High	IF2DTA2H1		R/W
000852 <sub>H</sub>	CAN1 - IF2 Data B1 Low	IF2DTB1L1	IF2DTB11	R/W
000853 <sub>H</sub>	CAN1 - IF2 Data B1 High	IF2DTB1H1		R/W
000854 <sub>H</sub>	CAN1 - IF2 Data B2 Low	IF2DTB2L1	IF2DTB21	R/W
000855 <sub>H</sub>	CAN1 - IF2 Data B2 High	IF2DTB2H1		R/W
000856 <sub>H</sub> -00087F <sub>H</sub>	Reserved			-
000880 <sub>H</sub>	CAN1 - Transmission Request 1 Register Low	TREQR1L1	TREQR11	R
000881 <sub>H</sub>	CAN1 - Transmission Request 1 Register High	TREQR1H1		R
000882 <sub>H</sub>	CAN1 - Transmission Request 2 Register Low	TREQR2L1	TREQR21	R
000883 <sub>H</sub>	CAN1 - Transmission Request 2 Register High	TREQR2H1		R
000884 <sub>H</sub> -00088F <sub>H</sub>	Reserved			-
000890 <sub>H</sub>	CAN1 - New Data 1 Register Low	NEWDT1L1	NEWDT11	R
000891 <sub>H</sub>	CAN1 - New Data 1 Register High	NEWDT1H1		R
000892 <sub>H</sub>	CAN1 - New Data 2 Register Low	NEWDT2L1	NEWDT21	R
000893 <sub>H</sub>	CAN1 - New Data 2 Register High	NEWDT2H1		R
000894 <sub>H</sub> -00089F <sub>H</sub>	Reserved			-
0008A0 <sub>H</sub>	CAN1 - Interrupt Pending 1 Register Low	INTPND1L1	INTPND11	R
0008A1 <sub>H</sub>	CAN1 - Interrupt Pending 1 Register High	INTPND1H1		R
0008A2 <sub>H</sub>	CAN1 - Interrupt Pending 2 Register Low	INTPND2L1	INTPND21	R
0008A3 <sub>H</sub>	CAN1 - Interrupt Pending 2 Register High	INTPND2H1		R
0008A4 <sub>H</sub> -0008AF <sub>H</sub>	Reserved			-
0008B0 <sub>H</sub>	CAN1 - Message Valid 1 Register Low	MSGVAL1L1	MSGVAL11	R
0008B1 <sub>H</sub>	CAN1 - Message Valid 1 Register High	MSGVAL1H1		R
0008B2 <sub>H</sub>	CAN1 - Message Valid 2 Register Low	MSGVAL2L1	MSGVAL21	R

**Table 4: I/O Map CY96(F)32x**

Address	Register	Abbreviation 8-bit access	Abbreviation 16-bit access	Access
0008B3 <sub>H</sub>	CAN1 - Message Valid 2 Register High	MSGVAL2H1		R
0008B4 <sub>H</sub> -0008CD <sub>H</sub>	Reserved			-
0008CE <sub>H</sub>	CAN1 - Output enable register	COER1		R/W
0008CF <sub>H</sub> -0008FF <sub>H</sub>	Reserved			-
000900 <sub>H</sub>	CAN2 - Control register Low	CTRLRL2	CTRLR2	R/W
000901 <sub>H</sub>	CAN2 - Control register High (reserved)	CTRLRH2		R
000902 <sub>H</sub>	CAN2 - Status register Low	STATRL2	STATR2	R/W
000903 <sub>H</sub>	CAN2 - Status register High (reserved)	STATRH2		R
000904 <sub>H</sub>	CAN2 - Error Counter Low (Transmit)	ERRCNTL2	ERRCNT2	R
000905 <sub>H</sub>	CAN2 - Error Counter High (Receive)	ERRCNTH2		R
000906 <sub>H</sub>	CAN2 - Bit Timing Register Low	BTRL2	BTR2	R/W
000907 <sub>H</sub>	CAN2 - Bit Timing Register High	BTRH2		R/W
000908 <sub>H</sub>	CAN2 - Interrupt Register Low	INTRL2	INTR2	R
000909 <sub>H</sub>	CAN2 - Interrupt Register High	INTRH2		R
00090A <sub>H</sub>	CAN2 - Test Register Low	TESTRL2	TESTR2	R/W
00090B <sub>H</sub>	CAN2 - Test Register High (reserved)	TESTRH2		R
00090C <sub>H</sub>	CAN2 - BRP Extension register Low	BRPERL2	BRPER2	R/W
00090D <sub>H</sub>	CAN2 - BRP Extension register High (reserved)	BRPERH2		R
00090E <sub>H</sub> -00090F <sub>H</sub>	Reserved			-
000910 <sub>H</sub>	CAN2 - IF1 Command request register Low	IF1CREQL2	IF1CREQ2	R/W
000911 <sub>H</sub>	CAN2 - IF1 Command request register High	IF1CREQH2		R/W
000912 <sub>H</sub>	CAN2 - IF1 Command Mask register Low	IF1CMSKL2	IF1CMSK2	R/W
000913 <sub>H</sub>	CAN2 - IF1 Command Mask register High (reserved)	IF1CMSKH2		R
000914 <sub>H</sub>	CAN2 - IF1 Mask 1 Register Low	IF1MSK1L2	IF1MSK12	R/W
000915 <sub>H</sub>	CAN2 - IF1 Mask 1 Register High	IF1MSK1H2		R/W
000916 <sub>H</sub>	CAN2 - IF1 Mask 2 Register Low	IF1MSK2L2	IF1MSK22	R/W
000917 <sub>H</sub>	CAN2 - IF1 Mask 2 Register High	IF1MSK2H2		R/W
000918 <sub>H</sub>	CAN2 - IF1 Arbitration 1 Register Low	IF1ARB1L2	IF1ARB12	R/W
000919 <sub>H</sub>	CAN2 - IF1 Arbitration 1 Register High	IF1ARB1H2		R/W
00091A <sub>H</sub>	CAN2 - IF1 Arbitration 2 Register Low	IF1ARB2L2	IF1ARB22	R/W
00091B <sub>H</sub>	CAN2 - IF1 Arbitration 2 Register High	IF1ARB2H2		R/W
00091C <sub>H</sub>	CAN2 - IF1 Message Control Register Low	IF1MCTRL2	IF1MCTR2	R/W

**Table 4: I/O Map CY96(F)32x**

Address	Register	Abbreviation 8-bit access	Abbreviation 16-bit access	Access
00091D <sub>H</sub>	CAN2 - IF1 Message Control Register High	IF1MCTR2H		R/W
00091E <sub>H</sub>	CAN2 - IF1 Data A1 Low	IF1DTA1L2	IF1DTA12	R/W
00091F <sub>H</sub>	CAN2 - IF1 Data A1 High	IF1DTA1H2		R/W
000920 <sub>H</sub>	CAN2 - IF1 Data A2 Low	IF1DTA2L2	IF1DTA22	R/W
000921 <sub>H</sub>	CAN2 - IF1 Data A2 High	IF1DTA2H2		R/W
000922 <sub>H</sub>	CAN2 - IF1 Data B1 Low	IF1DTB1L2	IF1DTB12	R/W
000923 <sub>H</sub>	CAN2 - IF1 Data B1 High	IF1DTB1H2		R/W
000924 <sub>H</sub>	CAN2 - IF1 Data B2 Low	IF1DTB2L2	IF1DTB22	R/W
000925 <sub>H</sub>	CAN2 - IF1 Data B2 High	IF1DTB2H2		R/W
000926 <sub>H</sub> -00093F <sub>H</sub>	Reserved			-
000940 <sub>H</sub>	CAN2 - IF2 Command request register Low	IF2CREQL2	IF2CREQ2	R/W
000941 <sub>H</sub>	CAN2 - IF2 Command request register High	IF2CREQH2		R/W
000942 <sub>H</sub>	CAN2 - IF2 Command Mask register Low	IF2CMSKL2	IF2CMSK2	R/W
000943 <sub>H</sub>	CAN2 - IF2 Command Mask register High (reserved)	IF2CMSKH2		R
000944 <sub>H</sub>	CAN2 - IF2 Mask 1 Register Low	IF2MSK1L2	IF2MSK12	R/W
000945 <sub>H</sub>	CAN2 - IF2 Mask 1 Register High	IF2MSK1H2		R/W
000946 <sub>H</sub>	CAN2 - IF2 Mask 2 Register Low	IF2MSK2L2	IF2MSK22	R/W
000947 <sub>H</sub>	CAN2 - IF2 Mask 2 Register High	IF2MSK2H2		R/W
000948 <sub>H</sub>	CAN2 - IF2 Arbitration 1 Register Low	IF2ARB1L2	IF2ARB12	R/W
000949 <sub>H</sub>	CAN2 - IF2 Arbitration 1 Register High	IF2ARB1H2		R/W
00094A <sub>H</sub>	CAN2 - IF2 Arbitration 2 Register Low	IF2ARB2L2	IF2ARB22	R/W
00094B <sub>H</sub>	CAN2 - IF2 Arbitration 2 Register High	IF2ARB2H2		R/W
00094C <sub>H</sub>	CAN2 - IF2 Message Control Register Low	IF2MCTRL2	IF2MCTR2	R/W
00094D <sub>H</sub>	CAN2 - IF2 Message Control Register High	IF2MCTR2H		R/W
00094E <sub>H</sub>	CAN2 - IF2 Data A1 Low	IF2DTA1L2	IF2DTA12	R/W
00094F <sub>H</sub>	CAN2 - IF2 Data A1 High	IF2DTA1H2		R/W
000950 <sub>H</sub>	CAN2 - IF2 Data A2 Low	IF2DTA2L2	IF2DTA22	R/W
000951 <sub>H</sub>	CAN2 - IF2 Data A2 High	IF2DTA2H2		R/W
000952 <sub>H</sub>	CAN2 - IF2 Data B1 Low	IF2DTB1L2	IF2DTB12	R/W
000953 <sub>H</sub>	CAN2 - IF2 Data B1 High	IF2DTB1H2		R/W
000954 <sub>H</sub>	CAN2 - IF2 Data B2 Low	IF2DTB2L2	IF2DTB22	R/W
000955 <sub>H</sub>	CAN2 - IF2 Data B2 High	IF2DTB2H2		R/W

**Table 4: I/O Map CY96(F)32x**

Address	Register	Abbreviation 8-bit access	Abbreviation 16-bit access	Access
000956 <sub>H</sub> -00097F <sub>H</sub>	Reserved			-
000980 <sub>H</sub>	CAN2 - Transmission Request 1 Register Low	TREQR1L2	TREQR12	R
000981 <sub>H</sub>	CAN2 - Transmission Request 1 Register High	TREQR1H2		R
000982 <sub>H</sub>	CAN2 - Transmission Request 2 Register Low	TREQR2L2	TREQR22	R
000983 <sub>H</sub>	CAN2 - Transmission Request 2 Register High	TREQR2H2		R
000984 <sub>H</sub> -00098F <sub>H</sub>	Reserved			-
000990 <sub>H</sub>	CAN2 - New Data 1 Register Low	NEWDT1L2	NEWDT12	R
000991 <sub>H</sub>	CAN2 - New Data 1 Register High	NEWDT1H2		R
000992 <sub>H</sub>	CAN2 - New Data 2 Register Low	NEWDT2L2	NEWDT22	R
000993 <sub>H</sub>	CAN2 - New Data 2 Register High	NEWDT2H2		R
000994 <sub>H</sub> -00099F <sub>H</sub>	Reserved			-
0009A0 <sub>H</sub>	CAN2 - Interrupt Pending 1 Register Low	INTPND1L2	INTPND12	R
0009A1 <sub>H</sub>	CAN2 - Interrupt Pending 1 Register High	INTPND1H2		R
0009A2 <sub>H</sub>	CAN2 - Interrupt Pending 2 Register Low	INTPND2L2	INTPND22	R
0009A3 <sub>H</sub>	CAN2 - Interrupt Pending 2 Register High	INTPND2H2		R
0009A4 <sub>H</sub> -0009AF <sub>H</sub>	Reserved			-
0009B0 <sub>H</sub>	CAN2 - Message Valid 1 Register Low	MSGVAL1L2	MSGVAL12	R
0009B1 <sub>H</sub>	CAN2 - Message Valid 1 Register High	MSGVAL1H2		R
0009B2 <sub>H</sub>	CAN2 - Message Valid 2 Register Low	MSGVAL2L2	MSGVAL22	R
0009B3 <sub>H</sub>	CAN2 - Message Valid 2 Register High	MSGVAL2H2		R
0009B4 <sub>H</sub> -0009CD <sub>H</sub>	Reserved			-
0009CE <sub>H</sub>	CAN2 - Output enable register	COER2		R/W
0009CF <sub>H</sub> -000BFF <sub>H</sub>	Reserved			-

**Note:** Any write access to reserved addresses in the I/O map should not be performed. A read access to a reserved address results in reading 'X'. Registers of resources which are described in this table, but which are not supported by the device, should also be handled as "Reserved".

## 12. Interrupt Vector Table

**Table 5: Interrupt Vector Table CY96(F)32x**

Vector Number	Offset in Vector Table	Vector Name	Cleared by DMA	Index in ICR to Program	Description
0	3FC <sub>H</sub>	CALLV0	No	-	
1	3F8 <sub>H</sub>	CALLV1	No	-	
2	3F4 <sub>H</sub>	CALLV2	No	-	
3	3F0 <sub>H</sub>	CALLV3	No	-	
4	3EC <sub>H</sub>	CALLV4	No	-	
5	3E8 <sub>H</sub>	CALLV5	No	-	
6	3E4 <sub>H</sub>	CALLV6	No	-	
7	3E0 <sub>H</sub>	CALLV7	No	-	
8	3DC <sub>H</sub>	RESET	No	-	
9	3D8 <sub>H</sub>	INT9	No	-	
10	3D4 <sub>H</sub>	EXCEPTION	No	-	
11	3D0 <sub>H</sub>	NMI	No	-	Non-Maskable Interrupt
12	3CC <sub>H</sub>	DLY	No	12	Delayed Interrupt
13	3C8 <sub>H</sub>	RC_TIMER	No	13	RC Timer
14	3C4 <sub>H</sub>	MC_TIMER	No	14	Main Clock Timer
15	3C0 <sub>H</sub>	SC_TIMER	No	15	Sub Clock Timer
16	3BC <sub>H</sub>	PLL_UNLOCK	No	16	Reserved
17	3B8 <sub>H</sub>	EXTINT0	Yes	17	External Interrupt 0
18	3B4 <sub>H</sub>	EXTINT1	Yes	18	External Interrupt 1
19	3B0 <sub>H</sub>	EXTINT2	Yes	19	External Interrupt 2
20	3AC <sub>H</sub>	EXTINT3	Yes	20	External Interrupt 3
21	3A8 <sub>H</sub>	EXTINT4	Yes	21	External Interrupt 4
22	3A4 <sub>H</sub>	EXTINT5	Yes	22	External Interrupt 5
23	3A0 <sub>H</sub>	EXTINT7	Yes	23	External Interrupt 7
24	39C <sub>H</sub>	EXTINT8	Yes	24	External Interrupt 8
25	398 <sub>H</sub>	EXTINT9	Yes	25	External Interrupt 9
26	394 <sub>H</sub>	EXTINT10	Yes	26	External Interrupt 10
27	390 <sub>H</sub>	EXTINT11	Yes	27	External Interrupt 11
28	38C <sub>H</sub>	EXTINT12	Yes	28	External Interrupt 12
29	388 <sub>H</sub>	EXTINT13	Yes	29	External Interrupt 13
30	384 <sub>H</sub>	EXTINT14	Yes	30	External Interrupt 14
31	380 <sub>H</sub>	EXTINT15	Yes	31	External Interrupt 15
32	37C <sub>H</sub>	CAN1	No	32	CAN Controller 1
33	378 <sub>H</sub>	CAN2	No	33	CAN Controller 2
34	374 <sub>H</sub>	PPG0	Yes	34	Programmable Pulse Generator 0
35	370 <sub>H</sub>	PPG1	Yes	35	Programmable Pulse Generator 1
36	36C <sub>H</sub>	PPG2	Yes	36	Programmable Pulse Generator 2
37	368 <sub>H</sub>	PPG3	Yes	37	Programmable Pulse Generator 3

**Table 5: Interrupt Vector Table CY96(F)32x**

Vector Number	Offset in Vector Table	Vector Name	Cleared by DMA	Index in ICR to Program	Description
38	364 <sub>H</sub>	PPG4	Yes	38	Programmable Pulse Generator 4
39	360 <sub>H</sub>	PPG5	Yes	39	Programmable Pulse Generator 5
40	35C <sub>H</sub>	PPG6	Yes	40	Programmable Pulse Generator 6
41	358 <sub>H</sub>	PPG7	Yes	41	Programmable Pulse Generator 7
42	354 <sub>H</sub>	PPG8	Yes	42	Programmable Pulse Generator 8
43	350 <sub>H</sub>	PPG9	Yes	43	Programmable Pulse Generator 9
44	34C <sub>H</sub>	PPG10	Yes	44	Programmable Pulse Generator 10
45	348 <sub>H</sub>	PPG11	Yes	45	Programmable Pulse Generator 11
46	344 <sub>H</sub>	PPG12	Yes	46	Programmable Pulse Generator 12
47	340 <sub>H</sub>	PPG13	Yes	47	Programmable Pulse Generator 13
48	33C <sub>H</sub>	PPG14	Yes	48	Programmable Pulse Generator 14
49	338 <sub>H</sub>	PPG15	Yes	49	Programmable Pulse Generator 15
50	334 <sub>H</sub>	PPG16	Yes	50	Programmable Pulse Generator 16
51	330 <sub>H</sub>	PPG17	Yes	51	Programmable Pulse Generator 17
52	32C <sub>H</sub>	PPG18	Yes	52	Programmable Pulse Generator 18
53	328 <sub>H</sub>	PPG19	Yes	53	Programmable Pulse Generator 19
54	324 <sub>H</sub>	RLT0	Yes	54	Reload Timer 0
55	320 <sub>H</sub>	RLT1	Yes	55	Reload Timer 1
56	31C <sub>H</sub>	RLT2	Yes	56	Reload Timer 2
57	318 <sub>H</sub>	RLT3	Yes	57	Reload Timer 3
58	314 <sub>H</sub>	PPGRLT	Yes	58	Reload Timer 6 - dedicated for PPG
59	310 <sub>H</sub>	ICU0	Yes	59	Input Capture Unit 0
60	30C <sub>H</sub>	ICU1	Yes	60	Input Capture Unit 1
61	308 <sub>H</sub>	ICU2	Yes	61	Input Capture Unit 2
62	304 <sub>H</sub>	ICU3	Yes	62	Input Capture Unit 3
63	300 <sub>H</sub>	ICU4	Yes	63	Input Capture Unit 4
64	2FC <sub>H</sub>	ICU5	Yes	64	Input Capture Unit 5
65	2F8 <sub>H</sub>	ICU6	Yes	65	Input Capture Unit 6
66	2F4 <sub>H</sub>	ICU7	Yes	66	Input Capture Unit 7
67	2F0 <sub>H</sub>	ICU8	Yes	67	Input Capture Unit 8
68	2EC <sub>H</sub>	ICU9	Yes	68	Input Capture Unit 9
69	2E8 <sub>H</sub>	ICU10	Yes	69	Input Capture Unit 10
70	2E4 <sub>H</sub>	ICU11	Yes	70	Input Capture Unit 11
71	2E0 <sub>H</sub>	OCU4	Yes	71	Output Compare Unit 4
72	2DC <sub>H</sub>	OCU5	Yes	72	Output Compare Unit 5
73	2D8 <sub>H</sub>	OCU6	Yes	73	Output Compare Unit 6
74	2D4 <sub>H</sub>	OCU7	Yes	74	Output Compare Unit 7
75	2D0 <sub>H</sub>	OCU10	Yes	75	Output Compare Unit 10
76	2CC <sub>H</sub>	OCU11	Yes	76	Output Compare Unit 11

**Table 5: Interrupt Vector Table CY96(F)32x**

Vector Number	Offset in Vector Table	Vector Name	Cleared by DMA	Index in ICR to Program	Description
77	2C8 <sub>H</sub>	FRT0	Yes	77	Free Running Timer 0
78	2C4 <sub>H</sub>	FRT1	Yes	78	Free Running Timer 1
79	2C0 <sub>H</sub>	FRT2	Yes	79	Free Running Timer 2
80	2BC <sub>H</sub>	FRT3	Yes	80	Free Running Timer 3
81	2B8 <sub>H</sub>	RTC0	No	81	Real Timer Clock
82	2B4 <sub>H</sub>	CAL0	No	82	Clock Calibration Unit
83	2B0 <sub>H</sub>	IIC0	Yes	83	I2C interface
84	2AC <sub>H</sub>	ADC0	Yes	84	A/D Converter
85	2A8 <sub>H</sub>	LINR2	Yes	85	LIN USART 2 RX
86	2A4 <sub>H</sub>	LINT2	Yes	86	LIN USART 2 TX
87	2A0 <sub>H</sub>	LINR3	Yes	87	LIN USART 3 RX
88	29C <sub>H</sub>	LINT3	Yes	88	LIN USART 3 TX
89	298 <sub>H</sub>	LINR7	Yes	89	LIN USART 7 RX
90	294 <sub>H</sub>	LINT7	Yes	90	LIN USART 7 TX
91	290 <sub>H</sub>	LINR8	Yes	91	LIN USART 8 RX
92	28C <sub>H</sub>	LINT8	Yes	92	LIN USART 8 TX
93	288 <sub>H</sub>	FLASH_A	No	93	Flash memory A (only Flash devices)



## 13. Handling Devices

Special care is required for the following when handling the device:

- Latch-up prevention
- Unused pins handling
- External clock usage
- Unused sub clock signal
- Notes on PLL clock mode operation
- Power supply pins ( $V_{CC}/V_{SS}$ )
- Crystal oscillator circuit
- Turn on sequence of power supply to A/D converter and analog inputs
- Pin handling when not using the A/D converter
- Notes on energization
- Stabilization of power supply voltage
- Serial communication

### 13.1 Latch-up Prevention

CMOS IC chips may suffer latch-up under the following conditions:

- A voltage higher than  $V_{CC}$  or lower than  $V_{SS}$  is applied to an input or output pin.
- A voltage higher than the rated voltage is applied between  $V_{CC}$  pins and  $V_{SS}$  pins.

Latch-up may increase the power supply current dramatically, causing thermal damages to the device.

### 13.2 Unused Pins Handling

Unused input pins can be left open when the input is disabled (corresponding bit of Port Input Enable register PIER = 0).

Leaving unused input pins open when the input is enabled may result in misbehavior and possible permanent damage of the device. They must therefore be pulled up or pulled down through resistors. To prevent latch-up, those resistors should be more than 2 k $\Omega$ .

Unused bidirectional pins can be set either to the output state and be then left open, or to the input state with either input disabled or external pull-up/pull-down resistor as described above.

### 13.3 External Clock Usage

The permitted frequency range of an external clock depends on the oscillator type and configuration. See [AC Characteristics](#) for detailed modes and frequency limits. Single and opposite phase external clocks must be connected as follows:

### 13.3.1 Single Phase External Clock

- When using a single phase external clock, X0 pin must be driven and X1 pin left open.

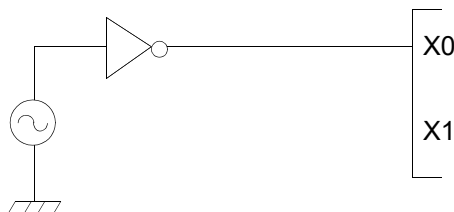

### 13.3.2 Opposite Phase External Clock

- When using an opposite phase external clock, X1 (X1A) must be supplied with a clock signal which has the opposite phase to the X0 (X0A) pins.

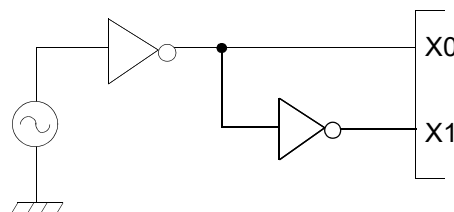

### 13.4 Unused Sub Clock Signal

If the pins X0A and X1A are not connected to an oscillator, a pull-down resistor must be connected on the X0A pin and the X1A pin must be left open.

### 13.5 Notes on PLL Clock Mode Operation

If the PLL clock mode is selected and no external oscillator is operating or no external clock is supplied, the microcontroller attempts to work with the free oscillating PLL. Performance of this operation, however, cannot be guaranteed.

### 13.6 Power Supply Pins ( $V_{CC}/V_{SS}$ )

It is required that all  $V_{CC}$ -level as well as all  $V_{SS}$ -level power supply pins are at the same potential. If there is more than one  $V_{CC}$  or  $V_{SS}$  level, the device may operate incorrectly or be damaged even within the guaranteed operating range.

$V_{CC}$  and  $V_{SS}$  must be connected to the device from the power supply with lowest possible impedance.

As a measure against power supply noise, it is required to connect a bypass capacitor of about 0.1  $\mu\text{F}$  between  $V_{CC}$  and  $V_{SS}$  as close as possible to  $V_{CC}$  and  $V_{SS}$  pins.

### 13.7 Crystal Oscillator and Ceramic Resonator Circuit

Noise at X0, X1 pins or X0A, X1A pins might cause abnormal operation. It is required to provide bypass capacitors with shortest possible distance to X0, X1 pins and X0A, X1A pins, crystal oscillator (or ceramic resonator) and ground lines, and, to the utmost effort, that the lines of oscillation circuit do not cross the lines of other circuits.

It is highly recommended to provide a printed circuit board art work surrounding X0, X1 pins and X0A, X1A pins with a ground area for stabilizing the operation.

It is highly recommended to evaluate the quartz/MCU or resonator/MCU system at the quartz or resonator manufacturer, especially when using low-Q resonators at higher frequencies.

### 13.8 Turn on Sequence of Power Supply to A/D Converter and Analog Inputs

It is required to turn the A/D converter power supply ( $AV_{CC}$ ,  $AV_{RH}$ ,  $AV_{RL}$ ) and analog inputs ( $AN_n$ ) on after turning the digital power supply ( $V_{CC}$ ) on.

It is also required to turn the digital power off after turning the A/D converter supply and analog inputs off. In this case, the voltage must not exceed  $AV_{RH}$  or  $AV_{CC}$  (turning the analog and digital power supplies simultaneously on or off is acceptable).

### 13.9 Pin Handling when Not Using the A/D Converter

It is required to connect the unused pins of the A/D converter as  $AV_{CC} = V_{CC}$ ,  $AV_{SS} = AV_{RH} = AV_{RL} = V_{SS}$ .

### 13.10 Notes on Power-on

To prevent malfunction of the internal voltage regulator, supply voltage profile while turning the power supply on should be slower than 50  $\mu$ s from 0.2 V to 2.7 V.

### 13.11 Stabilization of Power Supply Voltage

If the power supply voltage varies acutely even within the operation safety range of the  $V_{CC}$  power supply voltage, a malfunction may occur. The  $V_{CC}$  power supply voltage must therefore be stabilized. As stabilization guidelines, the power supply voltage must be stabilized in such a way that  $V_{CC}$  ripple fluctuations (peak to peak value) in the commercial frequencies (50 to 60 Hz) fall within 10 % of the standard  $V_{CC}$  power supply voltage and the transient fluctuation rate becomes 0.1 V/ $\mu$ s or less in instantaneous fluctuation for power supply switching.

### 13.12 Serial Communication

There is a possibility to receive wrong data due to noise or other causes on the serial communication.

Therefore, design a printed circuit board so as to avoid noise.

Consider receiving of wrong data when designing the system. For example apply a checksum and retransmit the data if an error occurs.

## 14. Electrical Characteristics

### 14.1 Absolute Maximum Ratings

Parameter	Symbol	Rating		Unit	Remarks
		Min	Max		
Power supply voltage	$V_{CC}$	$V_{SS} - 0.3$	$V_{SS} + 6.0$	V	
	$AV_{CC}$	$V_{SS} - 0.3$	$V_{SS} + 6.0$	V	$V_{CC} = AV_{CC}$ [1]
AD Converter voltage references	AVRH, AVRL	$V_{SS} - 0.3$	$V_{SS} + 6.0$	V	$AV_{CC} \geq AVRH$ , $AV_{CC} \geq AVRL$ , $AVRH > AVRL$ , $AVRL \geq AV_{SS}$
Input voltage	$V_I$	$V_{SS} - 0.3$	$V_{SS} + 6.0$	V	$V_I \leq V_{CC} + 0.3$ V [2]
Output voltage	$V_O$	$V_{SS} - 0.3$	$V_{SS} + 6.0$	V	$V_O \leq V_{CC} + 0.3$ V [2]
Maximum Clamp Current	$I_{CLAMP}$	-4.0	+4.0	mA	Applicable to general purpose I/O pins [3]
Total Maximum Clamp Current	$\Sigma  I_{CLAMP} $	-	40	mA	Applicable to general purpose I/O pins [3]
"L" level maximum output current	$I_{OL1}$	-	15	mA	Normal outputs with driving strength set to 5 mA
"L" level average output current	$I_{OLAV1}$	-	5	mA	Normal outputs with driving strength set to 5 mA
"L" level maximum overall output current	$\Sigma I_{OL1}$	-	100	mA	Normal outputs
"L" level average overall output current	$\Sigma I_{OLAV1}$	-	50	mA	Normal outputs
"H" level maximum output current	$I_{OH1}$	-	-15	mA	Normal outputs with driving strength set to 5 mA
"H" level average output current	$I_{OHAV1}$	-	-5	mA	Normal outputs with driving strength set to 5 mA
"H" level maximum overall output current	$\Sigma I_{OH1}$	-	-100	mA	Normal outputs
"H" level average overall output current	$\Sigma I_{OHAV1}$	-	-50	mA	Normal outputs
Permitted Power dissipation (Flash devices) [4]	$P_D$	-	300 <sup>[5]</sup>	mW	$T_A = 105$ °C
		-	600 <sup>[5]</sup>	mW	$T_A = 85$ °C
		-	750 <sup>[5]</sup>	mW	$T_A = 75$ °C
		-	375 <sup>[5]</sup>	mW	$T_A = 125$ °C, no Flash program/erase [6]
		-	530 <sup>[5]</sup>	mW	$T_A = 115$ °C, no Flash program/erase [6]
Operating ambient temperature	$T_A$	0	+70	°C	CY96V300B
		-40	+105		
		-40	+125		[6]
Storage temperature	$T_{STG}$	-55	+150	°C	

[1]:  $AV_{CC}$  and  $V_{CC}$  must be set to the same voltage. It is required that  $AV_{CC}$  does not exceed  $V_{CC}$  and that the voltage at the analog inputs does not exceed  $AV_{CC}$  neither when the power is switched on.

[2]:  $V_I$  and  $V_O$  should not exceed  $V_{CC} + 0.3$  V.  $V_I$  should also not exceed the specified ratings. However if the maximum current to/from a input is limited by some means with external components, the  $I_{CLAMP}$  rating supersedes the  $V_I$  rating. Input/output voltages of standard ports depend on  $V_{CC}$ .

[3]:

- Applicable to all general purpose I/O pins (Pnn\_m)
  - Use within recommended operating conditions.
  - Use at DC voltage (current)
  - The +B signal should always be applied a limiting resistance placed between the +B signal and the microcontroller.
  - The value of the limiting resistance should be set so that when the +B signal is applied the input current to the microcontroller pin does not exceed rated values, either instantaneously or for prolonged periods.
  - Note that when the microcontroller drive current is low, such as in the power saving modes, the +B input potential may pass through the protective diode and increase the potential at the VCC pin, and this may affect other devices.
  - Note that if a +B signal is input when the microcontroller power supply is off (not fixed at 0 V), the power supply is provided from the pins, so that incomplete operation may result.
- Note that if the +B input is applied during power-on, the power supply is provided from the pins and the resulting supply voltage may not be sufficient to operate the Power reset (except devices with persistent low voltage reset in internal vector mode).

**Sample Recommended Circuits:**

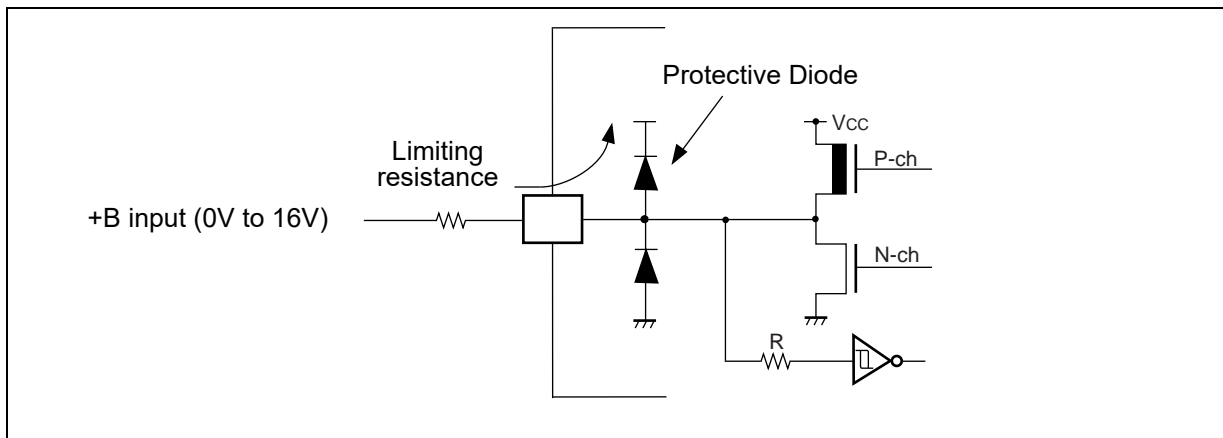

[4]: The maximum permitted power dissipation depends on the ambient temperature, the air flow velocity and the thermal conductance of the package on the PCB.

The actual power dissipation depends on the customer application and can be calculated as follows:

$$P_D = P_{IO} + P_{INT}$$

$$P_{IO} = \sum (V_{OL} * I_{OL} + V_{OH} * I_{OH}) \text{ (IO load power dissipation, sum is performed on all IO ports)}$$

$$P_{INT} = V_{CC} * (I_{CC} + I_A) \text{ (internal power dissipation)}$$

$I_{CC}$  is the total core current consumption into  $V_{CC}$  as described in the “DC characteristics” and depends on the selected operation mode and clock frequency and the usage of functions like Flash programming or the clock modulator.

$I_A$  is the analog current consumption into  $AV_{CC}$ .

[5]: Worst case value for a package mounted on single layer PCB at specified  $T_A$  without air flow.

[6]: Please contact Cypress for reliability limitations when using under these conditions.

**WARNING:** Semiconductor devices can be permanently damaged by application of stress (voltage, current, temperature, etc.) in excess of absolute maximum ratings. Do not exceed any of these ratings.

## 14.2 Recommended Operating Conditions

Parameter	Symbol	Value			Unit	Remarks
		Min	Typ	Max		
Power supply voltage	$V_{CC}$	3.0	-	5.5	V	
Smoothing capacitor at C pin	$C_S$	3.5	4.7 - 10	15	$\mu F$	Use a low inductance capacitor (for example X7R ceramic capacitor)

**WARNING:** The recommended operating conditions are required in order to ensure the normal operation of the semiconductor device. All of the device's electrical characteristics are warranted when the device is operated within these ranges. Always use semiconductor devices within their recommended operating condition ranges. Operation outside these ranges may adversely affect reliability and could result in device failure. No warranty is made with respect to uses, operating conditions, or combinations not represented on the data sheet. Users considering application outside the listed conditions are advised to contact their representatives beforehand.

### 14.3 DC Characteristics

( $T_A = -40\text{ }^\circ\text{C}$  to  $125\text{ }^\circ\text{C}$ ,  $V_{CC} = AV_{CC} = 3.0\text{ V}$  to  $5.5\text{ V}$ ,  $V_{SS} = AV_{SS} = 0\text{ V}$ )

Parameter	Symbol	Pin	Condition	Value			Unit	Remarks
				Min	Typ	Max		
Input H voltage	$V_{IH}$	Port inputs Pnn_m	CMOS Hysteresis 0.8/0.2 input selected	$0.8 V_{CC}$	-	$V_{CC} + 0.3$	V	
			CMOS Hysteresis 0.7/0.3 input selected	$0.7 V_{CC}$	-	$V_{CC} + 0.3$	V	$V_{CC} \geq 4.5\text{ V}$
				$0.74 V_{CC}$	-	$V_{CC} + 0.3$	V	$V_{CC} < 4.5\text{ V}$
			AUTOMOTIVE Hys- teresis input selected	$0.8 V_{CC}$	-	$V_{CC} + 0.3$	V	
			TTL input selected	2.0	-	$V_{CC} + 0.3$	V	
	$V_{IHX0F}$	X0	External clock in "Fast Clock Input mode"	$0.8 V_{CC}$	-	$V_{CC} + 0.3$	V	
	$V_{IHX0S}$	X0,X1, X0A,X1A	External clock in "os- cillation mode"	2.5	-	$V_{CC} + 0.3$	V	
	$V_{IHR}$	RSTX	-	$0.8 V_{CC}$	-	$V_{CC} + 0.3$	V	CMOS Hysteresis input
$V_{IHM}$	MD2-MD0	-	$V_{CC} - 0.3$	-	$V_{CC} + 0.3$	V		
Input L voltage	$V_{IL}$	Port inputs Pnn_m	CMOS Hysteresis 0.8/0.2 input selected	$V_{SS} - 0.3$	-	$0.2 V_{CC}$	V	
			CMOS Hysteresis 0.7/0.3 input selected	$V_{SS} - 0.3$	-	$0.3 V_{CC}$	V	
			AUTOMOTIVE Hys- teresis input selected	$V_{SS} - 0.3$	-	$0.5 V_{CC}$	V	$V_{CC} \geq 4.5\text{ V}$
				$V_{SS} - 0.3$	-	$0.46 V_{CC}$		$V_{CC} < 4.5\text{ V}$
			TTL input selected	$V_{SS} - 0.3$	-	0.8	V	
	$V_{ILX0F}$	X0	External clock in "Fast Clock Input mode"	$V_{SS} - 0.3$	-	$0.2 V_{CC}$	V	
	$V_{ILX0S}$	X0,X1, X0A,X1A	External clock in "os- cillation mode"	$V_{SS} - 0.3$	-	0.4	V	
	$V_{ILR}$	RSTX	-	$V_{SS} - 0.3$	-	$0.2 V_{CC}$	V	CMOS Hysteresis input
$V_{ILM}$	MD2-MD0	-	$V_{SS} - 0.3$	-	$V_{SS} + 0.3$	V		
Output H voltage	$V_{OH2}$	Normal out- puts	$4.5\text{ V} \leq V_{CC} \leq 5.5\text{ V}$ $I_{OH} = -2\text{ mA}$	$V_{CC} - 0.5$	-	-	V	Driving strength set to 2 mA
			$3.0\text{ V} \leq V_{CC} < 4.5\text{ V}$ $I_{OH} = -1.6\text{ mA}$					
	$V_{OH5}$	Normal out- puts	$4.5\text{ V} \leq V_{CC} \leq 5.5\text{ V}$ $I_{OH} = -5\text{ mA}$	$V_{CC} - 0.5$	-	-	V	Driving strength set to 5 mA
			$3.0\text{ V} \leq V_{CC} < 4.5\text{ V}$ $I_{OH} = -3\text{ mA}$					
	$V_{OH3}$	3 mA outputs	$4.5\text{ V} \leq V_{CC} \leq 5.5\text{ V}$ $I_{OH} = -3\text{ mA}$	$V_{CC} - 0.5$	-	-	V	
			$3.0\text{ V} \leq V_{CC} < 4.5\text{ V}$ $I_{OH} = -2\text{ mA}$					

( $T_A = -40\text{ }^\circ\text{C}$  to  $125\text{ }^\circ\text{C}$ ,  $V_{CC} = AV_{CC} = 3.0\text{ V}$  to  $5.5\text{ V}$ ,  $V_{SS} = AV_{SS} = 0\text{ V}$ )

Parameter	Symbol	Pin	Condition	Value			Unit	Remarks
				Min	Typ	Max		
Output L voltage	$V_{OL2}$	Normal out-puts	$4.5\text{ V} \leq V_{CC} \leq 5.5\text{ V}$ $I_{OL} = +2\text{ mA}$	-	-	0.4	V	Driving strength set to 2 mA
			$3.0\text{ V} \leq V_{CC} < 4.5\text{ V}$ $I_{OL} = +1.6\text{ mA}$					
	$V_{OL5}$	Normal out-puts	$4.5\text{ V} \leq V_{CC} \leq 5.5\text{ V}$ $I_{OL} = +5\text{ mA}$	-	-	0.4	V	Driving strength set to 5 mA
$3.0\text{ V} \leq V_{CC} < 4.5\text{ V}$ $I_{OL} = +3\text{ mA}$								
	$V_{OL3}$	3 mA outputs	$3.0\text{ V} \leq V_{CC} \leq 5.5\text{ V}$ $I_{OL} = +3\text{ mA}$	-	-	0.4	V	
Input leak current	$I_{IL}$	Pnn_m	$V_{SS} < V_I < V_{CC}$ $AV_{SS}, AVR_L < V_I < AV_{CC}, AVR_H$	-1	-	+1	$\mu\text{A}$	Single port pin
Pull-up resistance	$R_{UP}$	Pnn_m, RSTX	$V_{CC} = 3.3\text{ V} \pm 10\%$	40	100	160	$\text{k}\Omega$	
			$V_{CC} = 5.0\text{ V} \pm 10\%$	25	50	100	$\text{k}\Omega$	

( $T_A = -40\text{ }^\circ\text{C}$  to  $125\text{ }^\circ\text{C}$ ,  $V_{CC} = AV_{CC} = 3.0\text{ V}$  to  $5.5\text{ V}$ ,  $V_{SS} = AV_{SS} = 0\text{ V}$ )

Parameter	Symbol	Condition (at $T_A$ )	Value			Remarks	
			Typ	Max	Unit		
Power supply current in Run modes <sup>[1]</sup>	$I_{CCPLL}$	PLL Run mode with $CLKS1/2 = 48\text{ MHz}$ , $CLKB = CLKP1/2 = 24\text{ MHz}$ (CLKRC and CLKSC stopped. Core voltage at 1.9 V)	+25 $^\circ\text{C}$	35	44	mA	0 Flash wait states
			+125 $^\circ\text{C}$	36	47		
		PLL Run mode with $CLKS1/2 = 56\text{ MHz}$ , $CLKB = CLKP1 = 56\text{ MHz}$ , $CLKP2 = 28\text{ MHz}$ (CLKRC and CLKSC stopped. Core voltage at 1.9 V)	+25 $^\circ\text{C}$	44	57	mA	2 Flash wait states
			+125 $^\circ\text{C}$	45	60		
	PLL Run mode with $CLKS1/2 = 96\text{ MHz}$ , $CLKB = CLKP1 = 48\text{ MHz}$ , $CLKP2 = 24\text{ MHz}$ (CLKRC and CLKSC stopped. Core voltage at 1.9 V)	+25 $^\circ\text{C}$	49	62	mA	1 Flash wait state	
		+125 $^\circ\text{C}$	50	65			
	$I_{CCMAIN}$	Main Run mode with $CLKS1/2 = 4\text{ MHz}$ $CLKB = CLKP1/2 = 4\text{ MHz}$ (CLKPLL, CLKSC and CLKRC stopped)	+25 $^\circ\text{C}$	4.5	5.5	mA	1 Flash wait state
			+125 $^\circ\text{C}$	5.1	8.5		
$I_{CCRCH}$	RC Run mode with $CLKS1/2 = 2\text{ MHz}$ $CLKB = CLKP1/2 = 2\text{ MHz}$ (CLKMC, CLKPLL and CLKSC stopped)	+25 $^\circ\text{C}$	2.9	4	mA	1 Flash wait state	
		+125 $^\circ\text{C}$	3.5	6.5			



( $T_A = -40\text{ }^\circ\text{C}$  to  $125\text{ }^\circ\text{C}$ ,  $V_{CC} = AV_{CC} = 3.0\text{ V}$  to  $5.5\text{ V}$ ,  $V_{SS} = AV_{SS} = 0\text{ V}$ )

Parameter	Symbol	Condition (at $T_A$ )		Value			Remarks		
				Typ	Max	Unit			
Power supply current in Run modes <sup>[1]</sup>	$I_{CCRCL}$	RC Run mode with $CLKS1/2 = CLKB = CLKP1/2 = 100\text{ kHz}$ , $SMCR:LPMS = 0$ ( $CLKMC$ , $CLKPLL$ and $CLKSC$ stopped. Voltage regulator in high power mode)	+25 °C	0.4	0.6	mA	1 Flash wait state		
			+125 °C	0.9	3.5				
				RC Run mode with $CLKS1/2 = CLKB = CLKP1/2 = 100\text{ kHz}$ , $SMCR:LPMS = 1$ ( $CLKMC$ , $CLKPLL$ and $CLKSC$ stopped. Voltage regulator in low power mode, no Flash programming/erasing allowed)	+25 °C	0.15	0.25	mA	1 Flash wait state
					+125 °C	0.65	3.2		
		$I_{CCSUB}$	Sub Run mode with $CLKS1/2 = CLKB = CLKP1/2 = 32\text{ kHz}$ ( $CLKMC$ , $CLKPLL$ and $CLKRC$ stopped, no Flash programming/erasing allowed)	+25 °C	0.1	0.2	mA	1 Flash wait state	
				+125 °C	0.6	3			
Power supply current in Sleep mode <sup>[1]</sup>	$I_{CCSPLL}$	PLL Sleep mode with $CLKS1/2 = 48\text{ MHz}$ , $CLKP1/2 = 24\text{ MHz}$ ( $CLKRC$ and $CLKSC$ stopped. Core voltage at 1.9 V)	+25 °C	9	10.5	mA			
			+125 °C	9.7	13				
				PLL Sleep mode with $CLKS1/2 = CLKP1 = 56\text{ MHz}$ , $CLKP2 = 28\text{ MHz}$ ( $CLKRC$ and $CLKSC$ stopped. Core voltage at 1.9 V)	+25 °C	14	15.5	mA	
					+125 °C	14.8	18		
				PLL Sleep mode with $CLKS1/2 = 96\text{ MHz}$ , $CLKP1 = 48\text{ MHz}$ , $CLKP2 = 24\text{ MHz}$ ( $CLKRC$ and $CLKSC$ stopped. Core voltage at 1.9 V)	+25 °C	15	16.5	mA	
					+125 °C	15.8	19		

( $T_A = -40\text{ }^\circ\text{C}$  to  $125\text{ }^\circ\text{C}$ ,  $V_{CC} = AV_{CC} = 3.0\text{ V}$  to  $5.5\text{ V}$ ,  $V_{SS} = AV_{SS} = 0\text{ V}$ )

Parameter	Symbol	Condition (at $T_A$ )		Value			Remarks
				Typ	Max	Unit	
Power supply current in Sleep modes <sup>[1]</sup>	$I_{CCSMAN}$	Main Sleep mode with $CLKS1/2 = CLKP1/2 = 4\text{ MHz}$ (CLKPLL, CLKSC and CLKRC stopped)	+25 °C	1.5	1.8	mA	
			+125 °C	2	4.5		
	$I_{CCSRCH}$	RC Sleep mode with $CLKS1/2 = CLKP1/2 = 2\text{ MHz}$ (CLKMC, CLKPLL and CLKSC stopped)	+25 °C	0.8	1.3	mA	
			+125 °C	1.4	4		
	$I_{CCSRCL}$	RC Sleep mode with $CLKS1/2 = CLKP1/2 = 100\text{ kHz}$ , SMCR:LPSS = 0 (CLKMC, CLKPLL and CLKSC stopped. Voltage regulator in high power mode)	+25 °C	0.3	0.5	mA	
			+125 °C	0.8	3.4		
		RC Sleep mode with $CLKS1/2 = CLKP1/2 = 100\text{ kHz}$ , SMCR:LPSS = 1 (CLKMC, CLKPLL and CLKSC stopped. Voltage regulator in low power mode)	+25 °C	0.06	0.15	mA	
			+125 °C	0.56	3		
$I_{CCSSUB}$	Sub Sleep mode with $CLKS1/2 = CLKP1/2 = 32\text{ kHz}$ (CLKMC, CLKPLL and CLKRC stopped)	+25 °C	0.04	0.12	mA		
		+125 °C	0.54	2.9			
Power supply current in Timer modes <sup>[1]</sup>	$I_{CCTPLL}$	PLL Timer mode with $CLKMC = 4\text{ MHz}$ , $CLKPLL = 48\text{ MHz}$ (CLKRC and CLKSC stopped. Core voltage at 1.9 V)	+25 °C	1.6	2	mA	
			+125 °C	2.1	4.8		

( $T_A = -40\text{ }^\circ\text{C}$  to  $125\text{ }^\circ\text{C}$ ,  $V_{CC} = AV_{CC} = 3.0\text{ V}$  to  $5.5\text{ V}$ ,  $V_{SS} = AV_{SS} = 0\text{ V}$ )

Parameter	Symbol	Condition (at $T_A$ )		Value			Remarks
				Typ	Max	Unit	
Power supply current in Timer modes <sup>[1]</sup>	$I_{CCTMAIN}$	Main Timer mode with CLKMC = 4 MHz, SMCR:LPMSS = 0 (CLKPLL, CLKRC and CLKSC stopped. Voltage regulator in high power mode)	+25 °C	0.35	0.5	mA	
			+125 °C	0.85	3.3		
		Main Timer mode with CLKMC = 4 MHz, SMCR:LPMSS = 1 (CLKPLL, CLKRC and CLKSC stopped. Voltage regulator in low power mode)	+25 °C	0.1	0.15	mA	
			+125 °C	0.6	2.9		
	$I_{CCTRCH}$	RC Timer mode with CLKRC = 2 MHz, SMCR:LPMSS = 0 (CLKMC, CLKPLL and CLKSC stopped. Voltage regulator in high power mode)	+25 °C	0.35	0.5	mA	
			+125 °C	0.85	3.3		
		RC Timer mode with CLKRC = 2 MHz, SMCR:LPMSS = 1 (CLKMC, CLKPLL and CLKSC stopped. Voltage regulator in low power mode)	+25 °C	0.1	0.15	mA	
			+125 °C	0.6	2.9		
	$I_{CCTRCL}$	RC Timer mode with CLKRC = 100 kHz, SMCR:LPMSS = 0 (CLKMC, CLKPLL and CLKSC stopped. Voltage regulator in high power mode)	+25 °C	0.3	0.45	mA	
			+125 °C	0.8	3.2		
		RC Timer mode with CLKRC = 100 kHz, SMCR:LPMSS = 1 (CLKMC, CLKPLL and CLKSC stopped. Voltage regulator in low power mode)	+25 °C	0.05	0.1	mA	
			+125 °C	0.55	2.8		
$I_{CCTSUB}$	Sub Timer mode with CLKSC = 32 kHz (CLKMC, CLKPLL and CLKRC stopped)	+25 °C	0.03	0.1	mA		
		+125 °C	0.53	2.8			
Power supply current in Stop Mode	$I_{CCH}$	VRCR:LPMB[2:0] = 110 <sub>B</sub> (Core voltage at 1.8 V)	+25 °C	0.02	0.08	mA	
			+125 °C	0.52	2.8		
		VRCR:LPMB[2:0] = 000 <sub>B</sub> (Core voltage at 1.2 V)	+25 °C	0.015	0.06	mA	
			+125 °C	0.4	2.3		
Power supply current for active Low Voltage detector	$I_{CCLVD}$	Low voltage detector enabled (RCR:LVDE = 1)	+25 °C	90	140	$\mu\text{A}$	This current must be added to all Power supply currents above
			+125 °C	100	150		
Power supply current for active Clock modulator	$I_{CCLOMO}$	Clock modulator enabled (CM-CR:PDX = 1)	-	3	4.5	mA	Must be added to all current above

( $T_A = -40\text{ }^\circ\text{C}$  to  $125\text{ }^\circ\text{C}$ ,  $V_{CC} = AV_{CC} = 3.0\text{ V}$  to  $5.5\text{ V}$ ,  $V_{SS} = AV_{SS} = 0\text{ V}$ )

Parameter	Symbol	Condition (at $T_A$ )		Value			Remarks
				Typ	Max	Unit	
Flash Write/Erase current	$I_{CCFLASH}$	Current for one Flash module	-	15	40	mA	Must be added to all current above
Input capacitance	$C_{IN}$	-	-	5	15	pF	Other than C, $AV_{CC}$ , $AV_{SS}$ , $AVRH$ , $AVRL$ , $V_{CC}$ , $V_{SS}$

[1]: The power supply current is measured with a 4 MHz external clock connected to the Main oscillator and a 32 kHz external clock connected to the Sub oscillator. See chapter "Standby mode and voltage regulator control circuit" of the Hardware Manual for further details about voltage regulator control.

## 14.4 AC Characteristics

### 14.4.1 Source Clock Timing

( $T_A = -40\text{ }^\circ\text{C}$  to  $125\text{ }^\circ\text{C}$ ,  $V_{CC} = AV_{CC} = 3.0\text{ V}$  to  $5.5\text{ V}$ ,  $V_{SS} = AV_{SS} = 0\text{ V}$ )

Parameter	Symbol	Pin	Value			Unit	Remarks
			Min	Typ	Max		
Clock frequency	$f_C$	X0, X1	3	-	16	MHz	When using a crystal oscillator, PLL off
			0	-	16	MHz	When using an opposite phase external clock, PLL off
			3.5	-	16	MHz	When using a crystal oscillator or opposite phase external clock, PLL on
Clock frequency	$f_{FCI}$	X0	0	-	56	MHz	When using a single phase external clock in "Fast Clock Input mode", PLL off
			3.5	-	56	MHz	When using a single phase external clock in "Fast Clock Input mode", PLL on
Clock frequency	$f_{CL}$	X0A, X1A	32	32.768	100	kHz	When using an oscillation circuit
			0	-	100	kHz	When using an opposite phase external clock
		X0A	0	-	50	kHz	When using a single phase external clock
Clock frequency	$f_{CR}$	-	50	100	200	kHz	When using slow frequency of RC oscillator
			1	2	4	MHz	When using fast frequency of RC oscillator
PLL Clock frequency	$f_{CLKVCO}$	-	64	-	200	MHz	Permitted VCO output frequency of PLL (CLKVCO)
PLL Phase Jitter	$T_{PSKEW}$	-	-	-	$\pm 5$	ns	For CLKMC (PLL input clock) $\geq 4\text{ MHz}$
Input clock pulse width	$P_{WH}, P_{WL}$	X0, X1	8	-	-	ns	Duty ratio is about 30 % to 70 %
Input clock pulse width	$P_{WHL}, P_{WLL}$	X0A, X1A	5	-	-	$\mu\text{s}$	

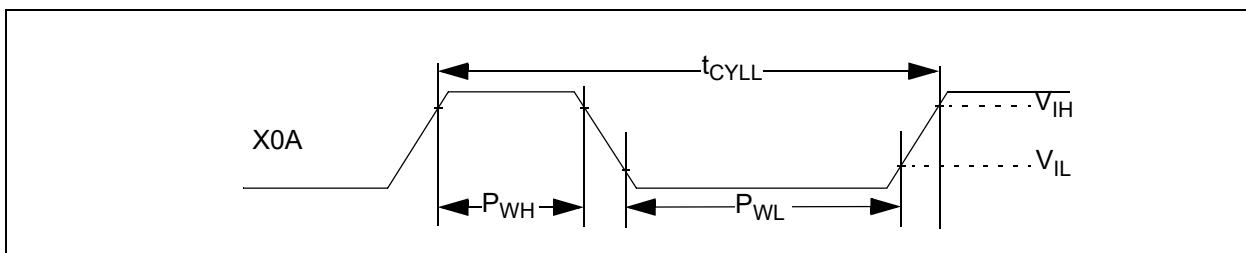
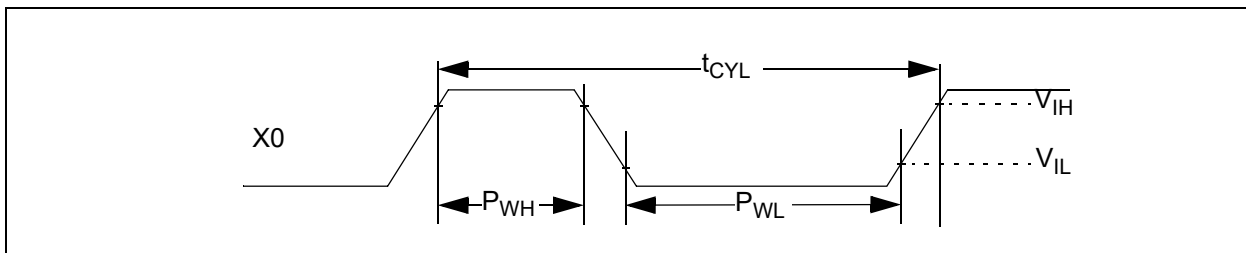

### 14.4.2 Internal Clock Timing

(T<sub>A</sub> = -40 °C to 125 °C, V<sub>CC</sub> = AV<sub>CC</sub> = 3.0 V to 5.5 V, V<sub>SS</sub> = AV<sub>SS</sub> = 0 V)

Parameter	Symbol	Core Voltage Settings				Unit	Remarks
		1.8 V		1.9 V			
		Min	Max	Min	Max		
Internal System clock frequency (CLKS1 and CLKS2)	f <sub>CLKS1</sub> , f <sub>CLKS2</sub>	0	92	0	96	MHz	Others than below
		0	88	0	96	MHz	CY96F326
Internal CPU clock frequency (CLKB), internal peripheral clock frequency (CLKP1)	f <sub>CLKB</sub> , f <sub>CLKP1</sub>	0	52	0	56	MHz	
Internal peripheral clock frequency (CLKP2)	f <sub>CLKP2</sub>	0	28	0	32	MHz	

### 14.4.3 External Reset Timing

( $T_A = -40\text{ }^\circ\text{C}$  to  $125\text{ }^\circ\text{C}$ ,  $V_{CC} = AV_{CC} = 3.0\text{ V}$  to  $5.5\text{ V}$ ,  $V_{SS} = AV_{SS} = 0\text{ V}$ )

Parameter	Symbol	Pin	Value			Unit	Remarks
			Min	Typ	Max		
Reset input time	$t_{RSTL}$	RSTX	500	-	-	ns	

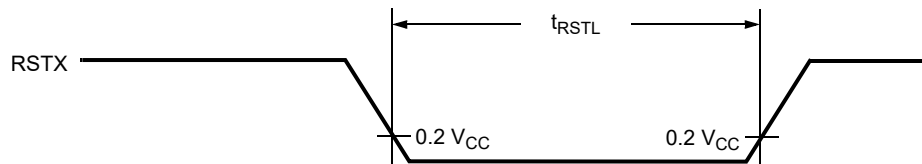

### 14.4.4 Power On Reset Timing

( $T_A = -40\text{ }^\circ\text{C}$  to  $125\text{ }^\circ\text{C}$ ,  $V_{CC} = AV_{CC} = 3.0\text{ V}$  to  $5.5\text{ V}$ ,  $V_{SS} = AV_{SS} = 0\text{ V}$ )

Parameter	Symbol	Pin	Value			Unit	Remarks
			Min	Typ	Max		
Power on rise time	$t_R$	Vcc	0.05	-	30	ms	
Power off time	$t_{OFF}$	Vcc	1	-	-	ms	

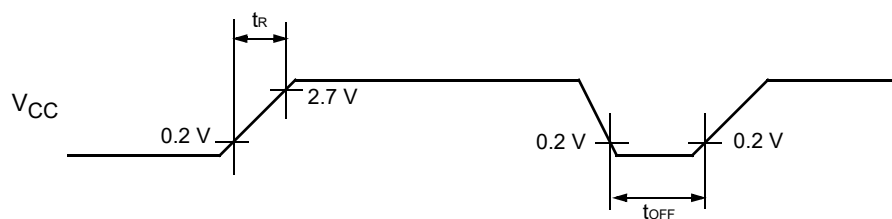

If the power supply is changed too rapidly, a power-on reset may occur. We recommend a smooth startup by restraining voltages when changing the power supply voltage during operation, as shown in the figure below.



### 14.4.5 External Input Timing

( $T_A = -40\text{ }^\circ\text{C}$  to  $125\text{ }^\circ\text{C}$ ,  $V_{CC} = AV_{CC} = 3.0\text{ V}$  to  $5.5\text{ V}$ ,  $V_{SS} = AV_{SS} = 0\text{ V}$ )

Parameter	Symbol	Pin	Condition	Value		Unit	Used Pin input function
				Min	Max		
Input pulse width	$t_{INH}$ $t_{INL}$	INTn(_R)	-	200	-	ns	External Interrupt
		NMI(_R)					NMI
		Pnn_m		$2 * t_{CLKP1} + 200$ ( $t_{CLKP1} = 1/f_{CLKP1}$ )	-	ns	General Purpose IO
		TINn(_R)					Reload Timer
		TTGn(_R)					PPG Trigger input
		ADTG(_R)					AD Converter Trigger
		FRCKn(_R)					Free Running Timer external clock
		INn(_R)					Input Capture

**Note :** Relocated Resource Inputs have same characteristics

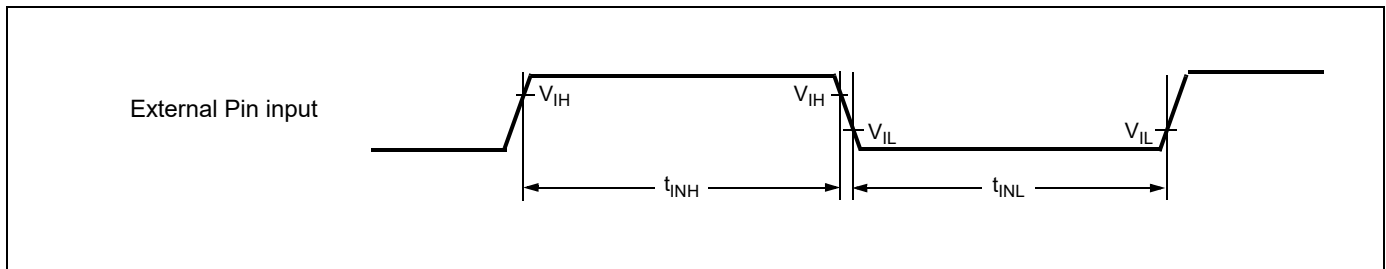

### 14.4.6 External Bus Timing

**Note:** The values given below are for an I/O driving strength  $I_{Odrive} = 5\text{ mA}$ . If  $I_{Odrive}$  is  $2\text{ mA}$ , all the maximum output timing described in the different tables must then be increased by  $10\text{ ns}$ .



### 14.4.7 Basic Timing

( $T_A = -40\text{ }^\circ\text{C}$  to  $+125\text{ }^\circ\text{C}$ ,  $V_{CC} = 5.0\text{ V} \pm 10\%$ ,  $V_{SS} = 0.0\text{ V}$ ,  $I_{Odrive} = 5\text{ mA}$ ,  $C_L = 50\text{ pF}$ )

Parameter	Symbol	Pin	Condition	Value		Unit	Remarks
				Min	Max		
ECLK	$t_{CYC}$	ECLK	-	25	-	ns	
	$t_{CHCL}$			$t_{CYC}/2-5$	$t_{CYC}/2+5$		
	$t_{CLCH}$			$t_{CYC}/2-5$	$t_{CYC}/2+5$		
ECLK → UBX/ LBX / CSn time	$t_{CHCBH}$	CSn, UBX, LBX, ECLK	-	-20	20	ns	
	$t_{CHCBL}$			-20	20		
	$t_{CLCBH}$			-20	20		
	$t_{CLCBL}$			-20	20		
ECLK → ALE time	$t_{CHLH}$	ALE, ECLK	-	-10	10	ns	
	$t_{CHLL}$			-10	10		
	$t_{CLLH}$			-10	10		
	$t_{CLLL}$			-10	10		
ECLK → address valid time	$t_{CHAV}$	A[23:16], ECLK	-	-15	15	ns	
	$t_{CLAV}$			-15	15		
	$t_{CLADV}$	AD[15:0], ECLK	-	-15	15	ns	
	$t_{CHADV}$			-15	15		
ECLK → RDX /WRX time	$t_{CHRWH}$	RDX, WRX, WRLX, WRHX, ECLK	-	-10	10	ns	
	$t_{CHRWL}$			-10	10		
	$t_{CLRWH}$			-10	10		
	$t_{CLRWL}$			-10	10		

( $T_A = -40\text{ }^\circ\text{C}$  to  $+125\text{ }^\circ\text{C}$ ,  $V_{CC} = 3.0\text{ V}$  to  $4.5\text{ V}$ ,  $V_{SS} = 0.0\text{ V}$ ,  $I_{Odrive} = 5\text{ mA}$ ,  $C_L = 50\text{ pF}$ )

Parameter	Symbol	Pin	Condition	Value		Unit	Remarks
				Min	Max		
ECLK	$t_{CYC}$	ECLK	-	30	-	ns	
	$t_{CHCL}$			$t_{CYC}/2-8$	$t_{CYC}/2+8$		
	$t_{CLCH}$			$t_{CYC}/2-8$	$t_{CYC}/2+8$		
ECLK → UBX/ LBX / CSn time	$t_{CHCBH}$	CSn, UBX, LBX, ECLK	-	-25	25	ns	
	$t_{CHCBL}$			-25	25		
	$t_{CLCBH}$			-25	25		
	$t_{CLCBL}$			-25	25		
ECLK → ALE time	$t_{CHLH}$	ALE, ECLK	-	-15	15	ns	
	$t_{CHLL}$			-15	15		
	$t_{CLLH}$			-15	15		
	$t_{CLLL}$			-15	15		

( $T_A = -40\text{ }^\circ\text{C}$  to  $+125\text{ }^\circ\text{C}$ ,  $V_{CC} = 3.0\text{ V}$  to  $4.5\text{ V}$ ,  $V_{SS} = 0.0\text{ V}$ ,  $I_{Odrive} = 5\text{ mA}$ ,  $C_L = 50\text{ pF}$ )

Parameter	Symbol	Pin	Condition	Value		Unit	Remarks
				Min	Max		
ECLK → address valid time	$t_{CHAV}$	A[23:16], ECLK	-	-20	20	ns	
	$t_{CLAV}$			-20	20		
	$t_{CLADV}$	AD[15:0], ECLK	-	-20	20	ns	
	$t_{CHADV}$			-20	20		
ECLK → RDX /WRX time	$t_{CHRWH}$	RDX, WRX, WRLX, WRHX, ECLK	-	-15	15	ns	
	$t_{CHRWL}$			-15	15		
	$t_{CLRWH}$			-15	15		
	$t_{CLRWL}$			-15	15		

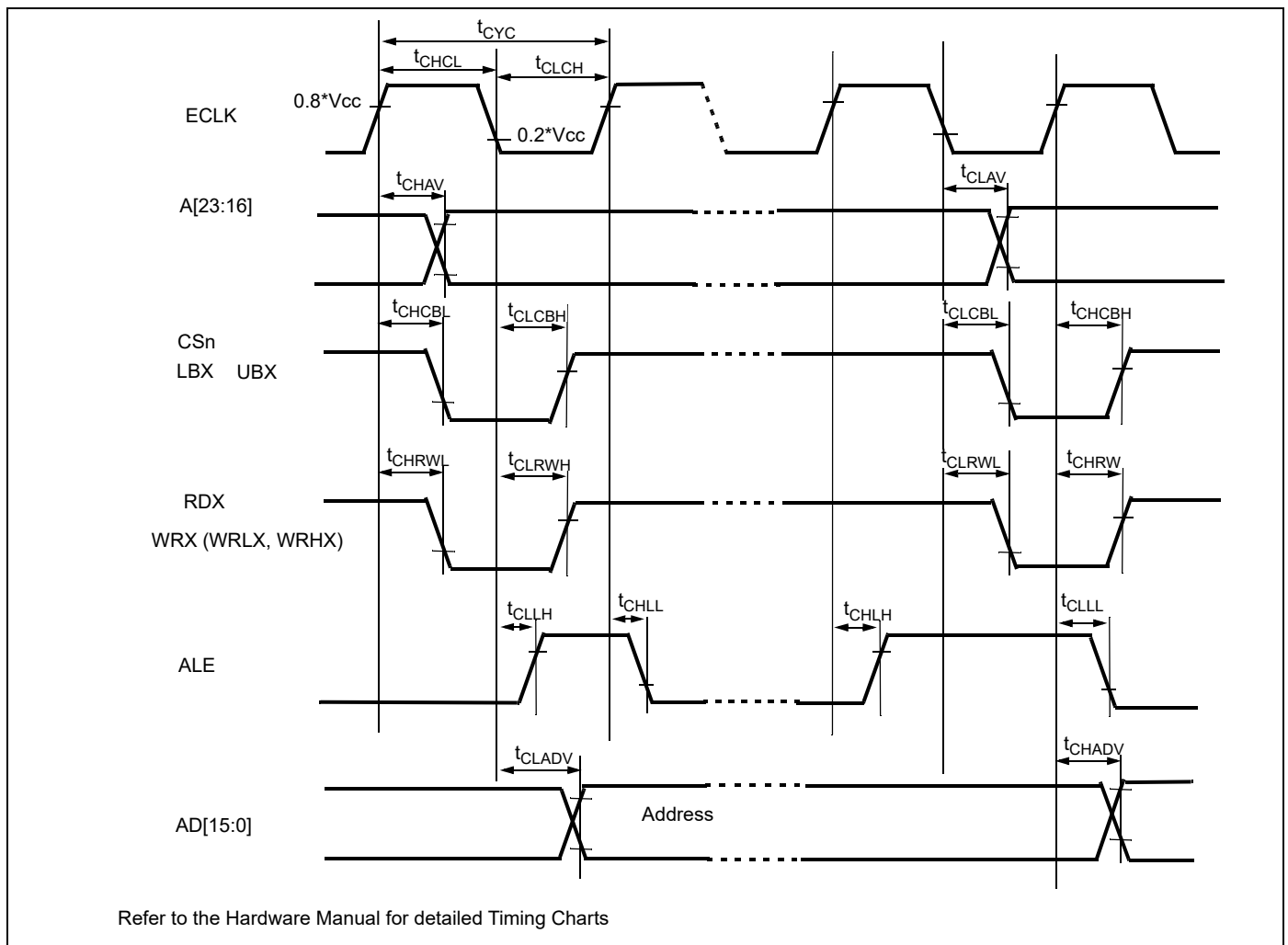

### 14.4.8 Bus Timing (Read)

( $T_A = -40\text{ }^{\circ}\text{C}$  to  $+125\text{ }^{\circ}\text{C}$ ,  $V_{CC} = 5.0\text{ V} \pm 10\%$ ,  $V_{SS} = 0.0\text{ V}$ ,  $I_{Odrive} = 5\text{ mA}$ ,  $C_L = 50\text{ pF}$ )

Parameter	Symbol	Pin	Conditions	Value		Unit	Remarks
				Min	Max		
ALE pulse width	$t_{LHLL}$	ALE	EACL:STS=0 and EACL:ACE=0	$t_{CYC}/2 - 5$	-	ns	
			EACL:STS=1	$t_{CYC} - 5$	-		
			EACL:STS=0 and EACL:ACE=1	$3t_{CYC}/2 - 5$	-		
Valid address $\Rightarrow$ ALE $\downarrow$ time	$t_{AVLL}$	ALE, A[23:16],	EACL:STS=0 and EACL:ACE=0	$t_{CYC} - 15$	-	ns	
			EACL:STS=1 and EACL:ACE=0	$3t_{CYC}/2 - 15$	-		
			EACL:STS=0 and EACL:ACE=1	$2t_{CYC} - 15$	-		
			EACL:STS=1 and EACL:ACE=1	$5t_{CYC}/2 - 15$	-		
	$t_{ADVLL}$	ALE, AD[15:0]	EACL:STS=0 and EACL:ACE=0	$t_{CYC}/2 - 15$	-	ns	
			EACL:STS=1 and EACL:ACE=0	$t_{CYC} - 15$	-		
			EACL:STS=0 and EACL:ACE=1	$3t_{CYC}/2 - 15$	-		
			EACL:STS=1 and EACL:ACE=1	$2t_{CYC} - 15$	-		
ALE $\downarrow \Rightarrow$ Address valid time	$t_{LLAX}$	ALE, AD[15:0]	EACL:STS=0	$t_{CYC}/2 - 15$	-	ns	
			EACL:STS=1	-15	-		
Valid address $\Rightarrow$ RDX $\downarrow$ time	$t_{AVRL}$	RDX, A[23:16]	EACL:ACE=0	$3t_{CYC}/2 - 15$	-	ns	
			EACL:ACE=1	$5t_{CYC}/2 - 15$	-		
	$t_{ADVRL}$	RDX, AD[15:0]	EACL:ACE=0	$t_{CYC} - 15$	-	ns	
			EACL:ACE=1	$2t_{CYC} - 15$	-		
Valid address $\Rightarrow$ Valid data input	$t_{AVDV}$	A[23:16], AD[15:0]	EACL:ACE=0	-	$3t_{CYC} - 55$	ns	w/o cycle extension
			EACL:ACE=1	-	$4t_{CYC} - 55$		
	$t_{ADVDV}$	AD[15:0]	EACL:ACE=0	-	$5t_{CYC}/2 - 55$	ns	w/o cycle extension
			EACL:ACE=1	-	$7t_{CYC}/2 - 55$		
RDX pulse width	$t_{RLRH}$	RDX	-	$3 t_{CYC}/2 - 5$	-	ns	w/o cycle extension
RDX $\downarrow \Rightarrow$ Valid data input	$t_{RLDV}$	RDX, AD[15:0]	-	-	$3 t_{CYC}/2 - 50$	ns	w/o cycle extension
RDX $\uparrow \Rightarrow$ Data hold time	$t_{RHDX}$	RDX, AD[15:0]	-	0	-	ns	
Address valid $\Rightarrow$ Data hold time	$t_{AXDX}$	A[23:16], AD[15:0]	-	0	-	ns	
RDX $\uparrow \Rightarrow$ ALE $\uparrow$ time	$t_{RHLH}$	RDX, ALE	EACL:STS=1 and EACL:ACE=1	$3t_{CYC}/2 - 10$	-	ns	
			other ECL:STS, EACL:ACE setting	$t_{CYC}/2 - 10$	-		
Valid address $\Rightarrow$ ECLK $\uparrow$ time	$t_{AVCH}$	A[23:16], ECLK	-	$t_{CYC} - 15$	-	ns	
	$t_{ADVCH}$	AD[15:0], ECLK	-	$t_{CYC}/2 - 15$	-		
RDX $\downarrow \Rightarrow$ ECLK $\uparrow$ time	$t_{RLCH}$	RDX, ECLK	-	$t_{CYC}/2 - 10$	-	ns	

( $T_A = -40\text{ }^\circ\text{C}$  to  $+125\text{ }^\circ\text{C}$ ,  $V_{CC} = 5.0\text{ V} \pm 10\%$ ,  $V_{SS} = 0.0\text{ V}$ ,  $I_{Odrive} = 5\text{ mA}$ ,  $C_L = 50\text{ pF}$ )

Parameter	Sym- bol	Pin	Conditions	Value		Unit	Remarks
				Min	Max		
ALE $\downarrow$ $\Rightarrow$ RDX $\downarrow$ time	$t_{LLRL}$	ALE, RDX	EACL:STS=0	$t_{CYC}/2 - 10$	-	ns	
			EACL:STS=1	- 10	-		
ECLK $\uparrow$ $\Rightarrow$ Valid data input	$t_{CHDV}$	AD[15:0], ECLK	-	-	$t_{CYC} - 50$	ns	

( $T_A = -40\text{ }^\circ\text{C}$  to  $+125\text{ }^\circ\text{C}$ ,  $V_{CC} = 3.0\text{ V}$  to  $4.5\text{ V}$ ,  $V_{SS} = 0.0\text{ V}$ ,  $I_{Odrive} = 5\text{ mA}$ ,  $C_L = 50\text{ pF}$ )

Parameter	Sym- bol	Pin	Conditions	Value		Unit	Remarks
				Min	Max		
ALE pulse width	$t_{LHLL}$	ALE	EACL:STS=0 and EACL:ACE=0	$t_{CYC}/2 - 8$	-	ns	
			EACL:STS=1	$t_{CYC} - 8$	-		
			EACL:STS=0 and EACL:ACE=1	$3t_{CYC}/2 - 8$	-		
Valid address $\Rightarrow$ ALE $\downarrow$ time	$t_{AVLL}$	ALE, A[23:16],	EACL:STS=0 and EACL:ACE=0	$t_{CYC} - 20$	-	ns	
			EACL:STS=1 and EACL:ACE=0	$3t_{CYC}/2 - 20$	-		
			EACL:STS=0 and EACL:ACE=1	$2t_{CYC} - 20$	-		
			EACL:STS=1 and EACL:ACE=1	$5t_{CYC}/2 - 20$	-		
	$t_{ADVLL}$	ALE, AD[15:0]	EACL:STS=0 and EACL:ACE=0	$t_{CYC}/2 - 20$	-	ns	
			EACL:STS=1 and EACL:ACE=0	$t_{CYC} - 20$	-		
			EACL:STS=0 and EACL:ACE=1	$3t_{CYC}/2 - 20$	-		
			EACL:STS=1 and EACL:ACE=1	$2t_{CYC} - 20$	-		
ALE $\downarrow$ $\Rightarrow$ Address valid time	$t_{LLAX}$	ALE, AD[15:0]	EACL:STS=0	$t_{CYC}/2 - 20$	-	ns	
			EACL:STS=1	-20	-		
Valid address $\Rightarrow$ RDX $\downarrow$ time	$t_{AVRL}$	RDX, A[23:16]	EACL:ACE=0	$3t_{CYC}/2 - 20$	-	ns	
			EACL:ACE=1	$5t_{CYC}/2 - 20$	-		
	$t_{ADVRL}$	RDX, AD[15:0]	EACL:ACE=0	$t_{CYC} - 20$	-	ns	
			EACL:ACE=1	$2t_{CYC} - 20$	-		
Valid address $\Rightarrow$ Valid data input	$t_{AVDV}$	A[23:16], AD[15:0]	EACL:ACE=0	-	$3t_{CYC} - 60$	ns	w/o cycle extension
			EACL:ACE=1	-	$4t_{CYC} - 60$		
	$t_{ADV DV}$	AD[15:0]	EACL:ACE=0	-	$5t_{CYC}/2 - 60$	ns	w/o cycle extension
			EACL:ACE=1	-	$7t_{CYC}/2 - 60$		
RDX pulse width	$t_{RLRH}$	RDX	-	$3t_{CYC}/2 - 8$	-	ns	w/o cycle extension
RDX $\downarrow$ $\Rightarrow$ Valid data input	$t_{RLDV}$	RDX, AD[15:0]	-	-	$3t_{CYC}/2 - 55$	ns	w/o cycle extension
RDX $\uparrow$ $\Rightarrow$ Data hold time	$t_{RHDX}$	RDX, AD[15:0]	-	0	-	ns	
Address valid $\Rightarrow$ Data hold time	$t_{AXDX}$	A[23:16]	-	0	-	ns	



### 14.4.9 Bus Timing (Write)

( $T_A = -40\text{ }^{\circ}\text{C}$  to  $+125\text{ }^{\circ}\text{C}$ ,  $V_{CC} = 5.0\text{ V} \pm 10\%$ ,  $V_{SS} = 0.0\text{ V}$ ,  $I_{Odrive} = 5\text{ mA}$ ,  $C_L = 50\text{ pF}$ )

Parameter	Symbol	Pin	Condition	Value		Unit	Remarks
				Min	Max		
Valid address $\Rightarrow$ WRX $\downarrow$ time	$t_{AVWL}$	WRX, WRLX, WRHX, A[23:16]	EACL:ACE=0	$3t_{CYC}/2 - 15$	-	ns	
			EACL:ACE=1	$5t_{CYC}/2 - 15$	-		
	$t_{ADVWL}$	WRX, WRLX, WRHX, AD[15:0]	EACL:ACE=0	$t_{CYC} - 15$	-	ns	
			EACL:ACE=1	$2t_{CYC} - 15$	-		
WRX pulse width	$t_{WLWH}$	WRX, WRLX, WRHX	-	$t_{CYC} - 5$	-	ns	w/o cycle extension
Valid data output $\Rightarrow$ WRX $\uparrow$ time	$t_{DVWH}$	WRX, WRLX, WRHX, AD[15:0]	-	$t_{CYC} - 20$	-	ns	w/o cycle extension
WRX $\uparrow \Rightarrow$ Data hold time	$t_{WHDX}$	WRX, WRLX, WRHX, AD[15:0]	-	$t_{CYC}/2 - 15$	-	ns	
WRX $\uparrow \Rightarrow$ Address valid time	$t_{WHAX}$	WRX, WRLX, WRHX, A[23:16]	-	$t_{CYC}/2 - 15$	-	ns	
WRX $\uparrow \Rightarrow$ ALE $\uparrow$ time	$t_{WHLH}$	WRX, WRLX, WRHX, ALE	EBM:ACE=1 and EACL:STS=1	$2t_{CYC} - 10$	-	ns	
			other EBM:ACE and EACL:STS setting	$t_{CYC} - 10$	-		
WRX $\downarrow \Rightarrow$ ECLK $\uparrow$ time	$t_{WLCH}$	WRX, WRLX, WRHX, ECLK	-	$t_{CYC}/2 - 10$	-	ns	
CSn $\Rightarrow$ WRX time	$t_{CSLWL}$	WRX, WRLX, WRHX, CSn	EACL:ACE=0	-	$3t_{CYC}/2 - 15$	ns	
			EACL:ACE=1	-	$5t_{CYC}/2 - 15$		
WRX $\Rightarrow$ CSn time	$t_{WHCSH}$	WRX, WRLX, WRHX, CSn	-	$t_{CYC}/2 - 15$	-	ns	

( $T_A = -40\text{ }^{\circ}\text{C}$  to  $+125\text{ }^{\circ}\text{C}$ ,  $V_{CC} = 3.0\text{ V}$  to  $4.5\text{ V}$ ,  $V_{SS} = 0.0\text{ V}$ ,  $I_{Odrive} = 5\text{ mA}$ ,  $C_L = 50\text{ pF}$ )

Parameter	Symbol	Pin	Condition	Value		Unit	Remarks
				Min	Max		
Valid address $\Rightarrow$ WRX $\downarrow$ time	$t_{AVWL}$	WRX, WRLX, WRHX, A[23:16]	EACL:ACE=0	$3t_{CYC}/2 - 20$	-	ns	
			EACL:ACE=1	$5t_{CYC}/2 - 20$	-		
	$t_{ADVWL}$	WRX, WRLX, WRHX, AD[15:0]	EACL:ACE=0	$t_{CYC} - 20$	-	ns	
			EACL:ACE=1	$2t_{CYC} - 20$	-		
WRX pulse width	$t_{WLWH}$	WRX, WRLX, WRHX	-	$t_{CYC} - 8$	-	ns	w/o cycle extension

( $T_A = -40\text{ }^{\circ}\text{C}$  to  $+125\text{ }^{\circ}\text{C}$ ,  $V_{CC} = 3.0\text{ V}$  to  $4.5\text{ V}$ ,  $V_{SS} = 0.0\text{ V}$ ,  $I_{Odrive} = 5\text{ mA}$ ,  $C_L = 50\text{ pF}$ )

Parameter	Symbol	Pin	Condition	Value		Unit	Remarks
				Min	Max		
Valid data output $\Rightarrow$ WRX $\uparrow$ time	$t_{DVWH}$	WRX, WRLX, WRHX, AD[15:0]	-	$t_{CYC} - 25$	-	ns	w/o cycle extension
WRX $\uparrow \Rightarrow$ Data hold time	$t_{WHDX}$	WRX, WRLX, WRHX, AD[15:0]	-	$t_{CYC}/2 - 20$	-	ns	
WRX $\uparrow \Rightarrow$ Address valid time	$t_{WHAX}$	WRX, WRLX, WRHX, A[23:16]	-	$t_{CYC}/2 - 20$	-	ns	
WRX $\uparrow \Rightarrow$ ALE $\uparrow$ time	$t_{WHLH}$	WRX, WRLX, WRHX, ALE	EBM:ACE=1 and EACL:STS=1	$2t_{CYC} - 15$	-	ns	
			other EBM:ACE and EACL:STS setting	$t_{CYC} - 15$	-		
WRX $\downarrow \Rightarrow$ ECLK $\uparrow$ time	$t_{WLCH}$	WRX, WRLX, WRHX, ECLK	-	$t_{CYC}/2 - 15$	-	ns	
CSn $\Rightarrow$ WRX time	$t_{CSLWL}$	WRX, WRLX, WRHX, CSn	EACL:ACE=0	-	$3t_{CYC}/2 - 20$	ns	
			EACL:ACE=1	-	$5t_{CYC}/2 - 20$		
WRX $\Rightarrow$ CSn time	$t_{WHCSH}$	WRX, WRLX, WRHX, CSn	-	$t_{CYC}/2 - 20$	-	ns	

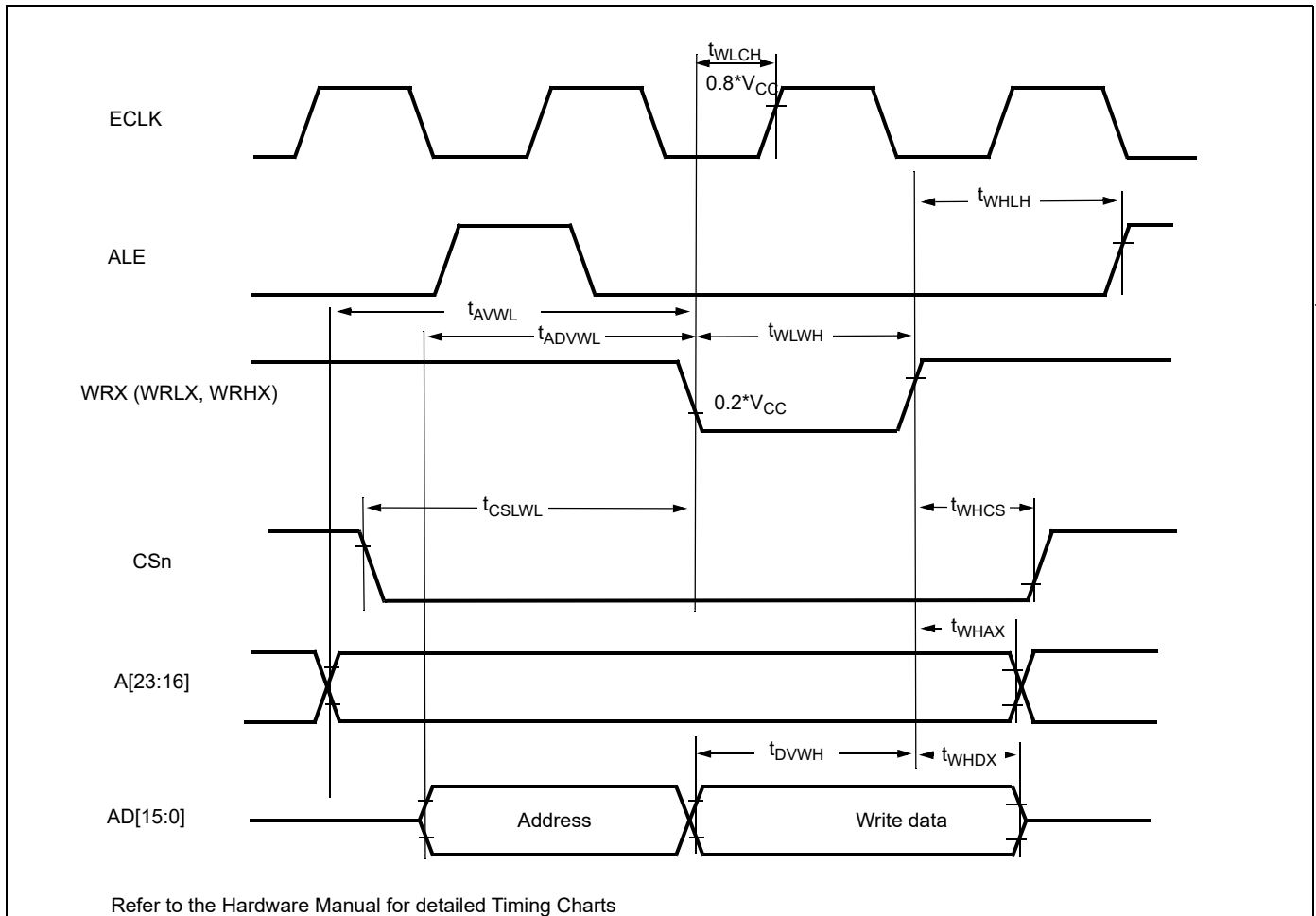

### 14.4.10 Ready Input Timing

( $T_A = -40\text{ }^\circ\text{C}$  to  $+125\text{ }^\circ\text{C}$ ,  $V_{CC} = 5.0\text{ V} \pm 10\%$ ,  $V_{SS} = 0.0\text{ V}$ ,  $I_{Odrive} = 5\text{ mA}$ ,  $C_L = 50\text{ pF}$ )

Parameter	Symbol	Pin	Test Condition	Rated Value		Units	Remarks
				Min	Max		
RDY setup time	$t_{RYHS}$	RDY	-	35	-	ns	
RDY hold time	$t_{RYHH}$	RDY		0	-	ns	

( $T_A = -40\text{ }^\circ\text{C}$  to  $+125\text{ }^\circ\text{C}$ ,  $V_{CC} = 3.0\text{ V}$  to  $4.5\text{ V}$ ,  $V_{SS} = 0.0\text{ V}$ ,  $I_{Odrive} = 5\text{ mA}$ ,  $C_L = 50\text{ pF}$ )

Parameter	Symbol	Pin	Test Condition	Rated Value		Units	Remarks
				Min	Max		
RDY setup time	$t_{RYHS}$	RDY	-	45	-	ns	
RDY hold time	$t_{RYHH}$	RDY		0	-	ns	

**Note** : If the RDY setup time is insufficient, use the auto-ready function.



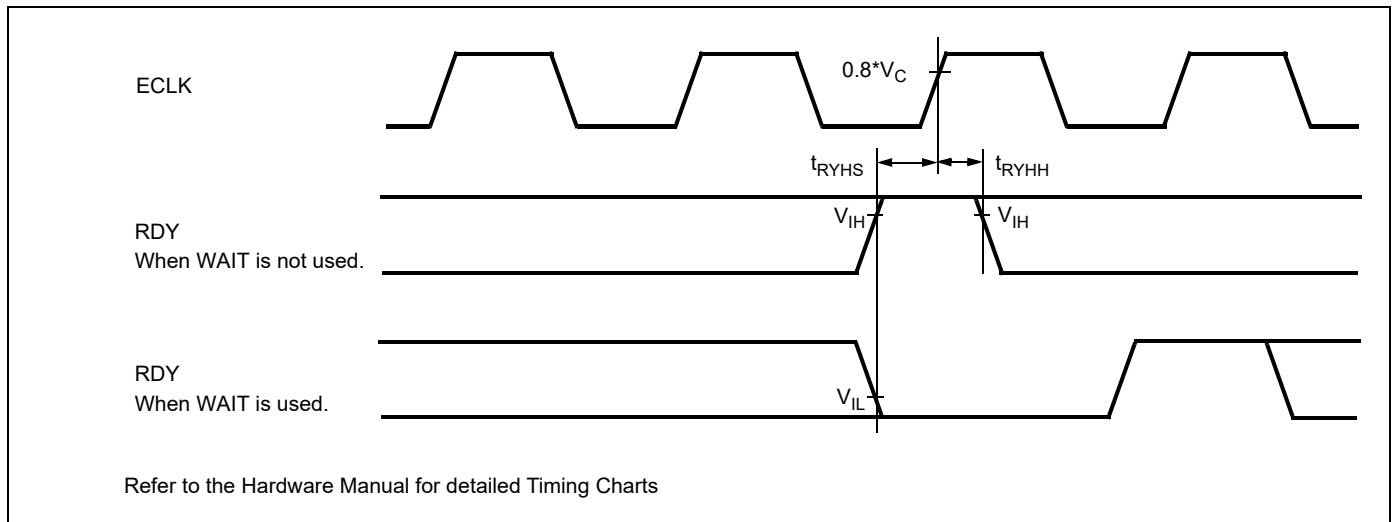

### 14.4.11 Hold Timing

( $T_A = -40\text{ }^\circ\text{C}$  to  $+125\text{ }^\circ\text{C}$ ,  $V_{CC} = 5.0\text{ V} \pm 10\%$ ,  $V_{SS} = 0.0\text{ V}$ ,  $I_{Odrive} = 5\text{ mA}$ ,  $C_L = 50\text{ pF}$ )

Parameter	Symbol	Pin	Condition	Value		Units	Remarks
				Min	Max		
Pin floating $\Rightarrow$ HAKX $\downarrow$ time	$t_{XHAL}$	HAKX	-	$t_{CYC} - 20$	$t_{CYC} + 20$	ns	
HAKX $\uparrow$ time $\Rightarrow$ Pin valid time	$t_{HAHV}$	HAKX		$t_{CYC} - 20$	$t_{CYC} + 20$	ns	

( $T_A = -40\text{ }^\circ\text{C}$  to  $+125\text{ }^\circ\text{C}$ ,  $V_{CC} = 3.0\text{ V}$  to  $4.5\text{ V}$ ,  $V_{SS} = 0.0\text{ V}$ ,  $I_{Odrive} = 5\text{ mA}$ ,  $C_L = 50\text{ pF}$ )

Parameter	Symbol	Pin	Condition	Value		Units	Remarks
				Min	Max		
Pin floating $\Rightarrow$ HAKX $\downarrow$ time	$t_{XHAL}$	HAKX	-	$t_{CYC} - 25$	$t_{CYC} + 25$	ns	
HAKX $\uparrow$ time $\Rightarrow$ Pin valid time	$t_{HAHV}$	HAKX		$t_{CYC} - 25$	$t_{CYC} + 25$	ns	

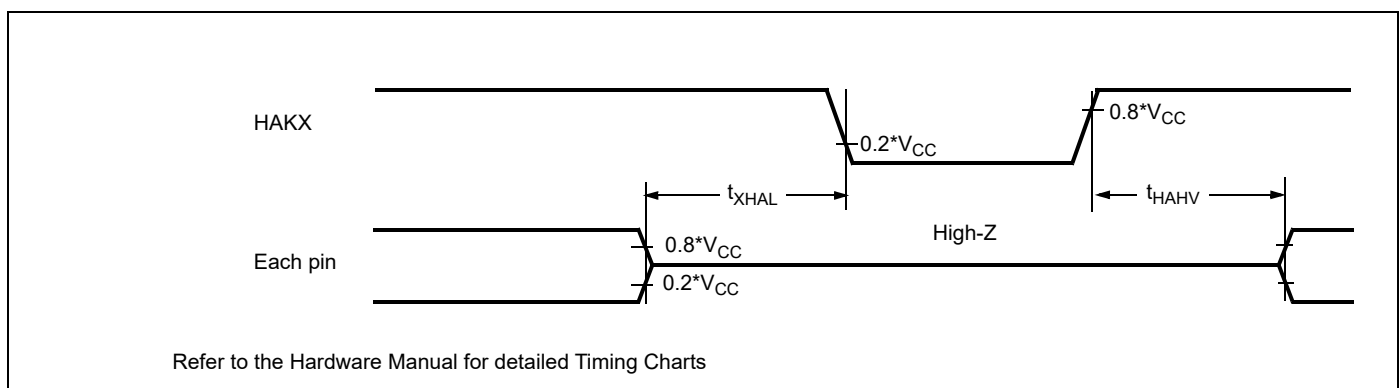

### 14.4.12 USART Timing

**WARNING:** The values given below are for an I/O driving strength  $I_{O_{drive}} = 5 \text{ mA}$ . If  $I_{O_{drive}}$  is 2 mA, all the maximum output timing described in the different tables must then be increased by 10 ns.

( $T_A = -40 \text{ }^\circ\text{C}$  to  $125 \text{ }^\circ\text{C}$ ,  $V_{CC} = 3.0 \text{ V}$  to  $5.5 \text{ V}$ ,  $V_{SS} = AV_{SS} = 0 \text{ V}$ ,  $I_{O_{drive}} = 5 \text{ mA}$ ,  $C_L = 50 \text{ pF}$ )

Parameter	Symbol	Pin	Condition	$V_{CC} = AV_{CC} = 4.5 \text{ V to } 5.5 \text{ V}$		$V_{CC} = AV_{CC} = 3.0 \text{ V to } 4.5 \text{ V}$		Unit
				Min	Max	Min	Max	
Serial clock cycle time	$t_{SCYCI}$	SCKn	Internal Shift Clock Mode	$4 t_{CLKP1}$	-	$4 t_{CLKP1}$	-	ns
SCK ↓ → SOT delay time	$t_{SLOVI}$	SCKn, SOTn		-20	+20	-30	+30	ns
SOT → SCK↑ delay time	$t_{OVSHI}$	SCKn, SOTn		$N * t_{CLKP1} - 20$ [1]	-	$N * t_{CLKP1} - 30$ [1]	-	ns
Valid SIN → SCK ↑	$t_{IVSHI}$	SCKn, SINn		$t_{CLKP1} + 45$	-	$t_{CLKP1} + 55$	-	ns
SCK ↑ → Valid SIN hold time	$t_{SHIXI}$	SCKn, SINn		0	-	0	-	ns
Serial clock "L" pulse width	$t_{LSHE}$	SCKn	External Shift Clock Mode	$t_{CLKP1} + 10$	-	$t_{CLKP1} + 10$	-	ns
Serial clock "H" pulse width	$t_{HSLE}$	SCKn		$t_{CLKP1} + 10$	-	$t_{CLKP1} + 10$	-	ns
SCK ↓ → SOT delay time	$t_{SLOVE}$	SCKn, SOTn		-	$2 t_{CLKP1} + 45$	-	$2 t_{CLKP1} + 55$	ns
Valid SIN → SCK↑	$t_{VSHE}$	SCKn, SINn		$t_{CLKP1}/2 + 10$	-	$t_{CLKP1}/2 + 10$	-	ns
SCK ↑ → Valid SIN hold time	$t_{SHIXE}$	SCKn, SINn		$t_{CLKP1} + 10$	-	$t_{CLKP1} + 10$	-	ns
SCK fall time	$t_{FE}$	SCKn		-	20	-	20	ns
SCK rise time	$t_{RE}$	SCKn		-	20	-	20	ns

**Notes:**

- AC characteristic in CLK synchronized mode.
- $C_L$  is the load capacity value of pins when testing. Depending on the used machine clock frequency, the maximum possible baud rate can be limited by some parameters. These parameters are shown in "CY96300 Super series HARDWARE MANUAL"
- $t_{CLKP1}$  is the cycle time of the peripheral clock 1 (CLKP1), Unit : ns

[1]: Parameter N depends on  $t_{SCYCI}$  and can be calculated as follows:

- if  $t_{SCYCI} = 2 * k * t_{CLKP1}$ , then  $N = k$ , where k is an integer > 2
- if  $t_{SCYCI} = (2 * k + 1) * t_{CLKP1}$ , then  $N = k + 1$ , where k is an integer > 1

Examples:

$t_{SCYCI}$	N
$4 * t_{CLKP1}$	2
$5 * t_{CLKP1}$	3
$7 * t_{CLKP1}$	4
...	...

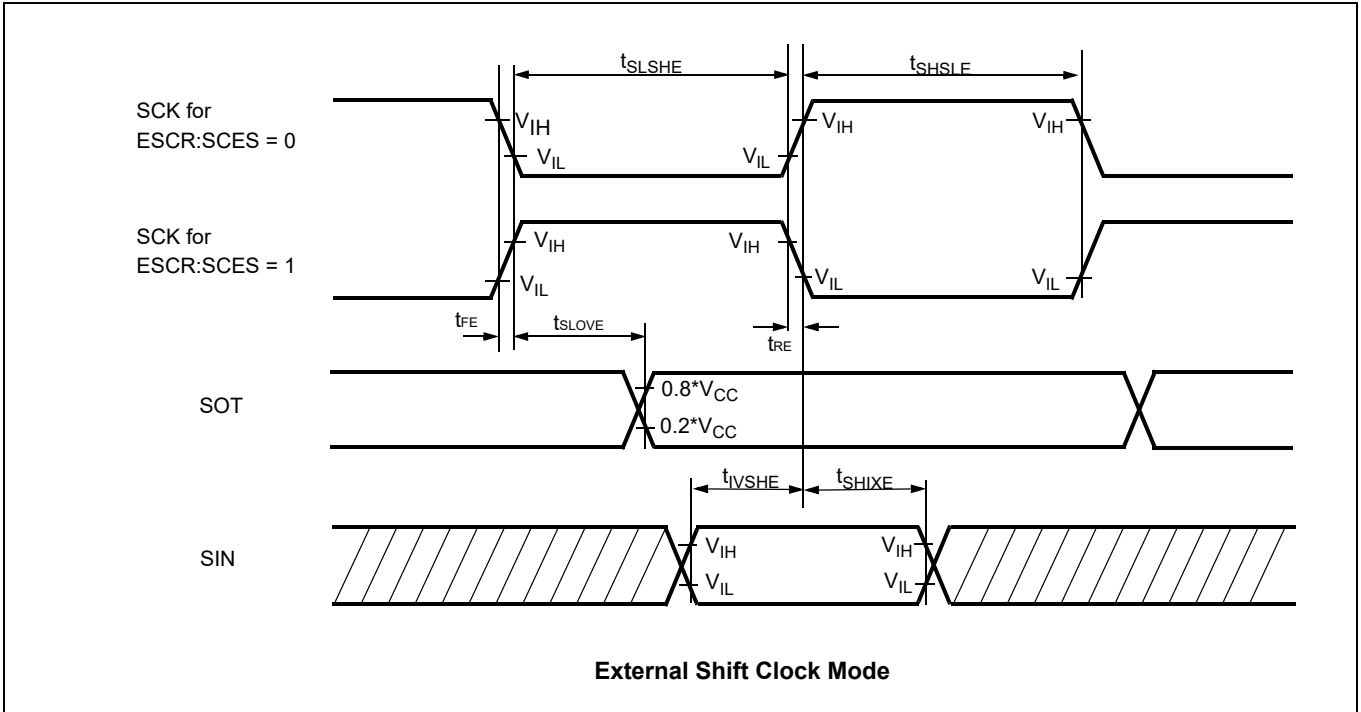
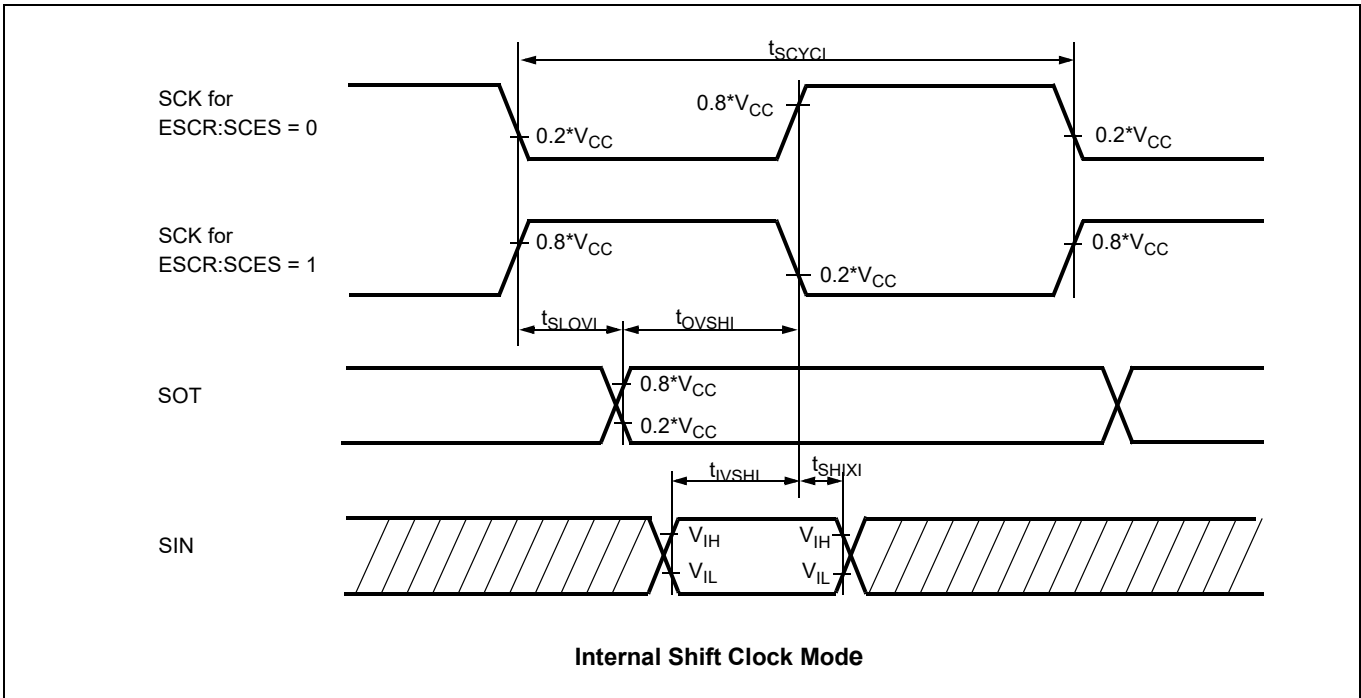

### 14.4.13 I<sup>2</sup>C Timing

(T<sub>A</sub> = -40 °C to 125 °C, V<sub>CC</sub> = AV<sub>CC</sub> = 3.0 V to 5.5 V, V<sub>SS</sub> = AV<sub>SS</sub> = 0 V)

Parameter	Symbol	Condition	Standard-mode		Fast-mode <sup>[4]</sup>		Unit
			Min	Max	Min	Max	
SCL clock frequency	f <sub>SCL</sub>	R = 1.7 kΩ, C = 50 pF <sup>[1]</sup>	0	100	0	400	kHz
Hold time (repeated) START condition SDA↓→SCL↓	t <sub>HDSTA</sub>		4.0	-	0.6	-	μs
"L" width of the SCL clock	t <sub>LOW</sub>		4.7	-	1.3	-	μs
"H" width of the SCL clock	t <sub>HIGH</sub>		4.0	-	0.6	-	μs
Set-up time for a repeated START condition SCL↑→SDA↓	t <sub>SUSTA</sub>		4.7	-	0.6	-	μs
Data hold time SCL↓→SDA↓↑	t <sub>HDDAT</sub>		0	3.45 <sup>[2]</sup>	0	0.9 <sup>[3]</sup>	μs
Data set-up time SDA↓↑→SCL↑	t <sub>SUDAT</sub>		250	-	100	-	ns
Set-up time for STOP condition SCL↑→SDA↑	t <sub>SUSTO</sub>		4.0	-	0.6	-	μs
Bus free time between a STOP and START condition	t <sub>BUS</sub>		4.7	-	1.3	-	μs

[1]: R, C : Pull-up resistor and load capacitor of the SCL and SDA lines.

[2]: The maximum t<sub>HDDAT</sub> have only to be met if the device does not stretch the "L" width (t<sub>LOW</sub>) of the SCL signal.

[3]: A Fast-mode I<sup>2</sup>C-bus device can be used in a Standard-mode I<sup>2</sup>C-bus system, but the requirement t<sub>SUDAT</sub> ≥ 250 ns must then be met.

[4]: For use at over 100 kHz, set the peripheral clock 1 to at least 6 MHz.

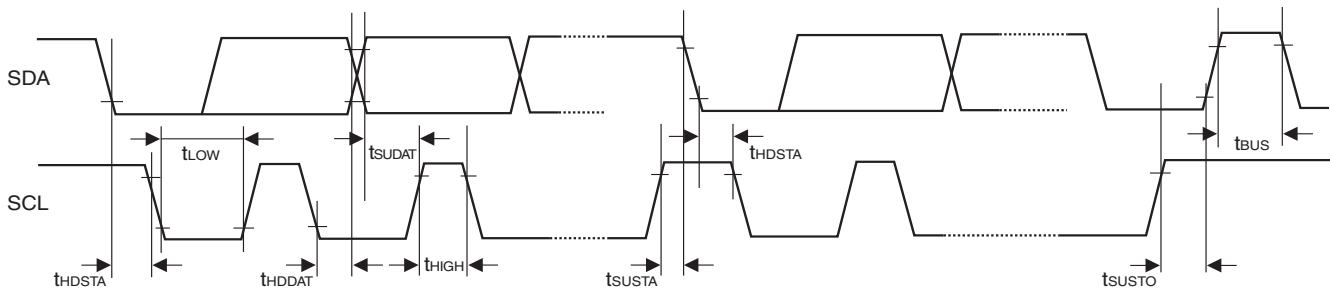

## 14.5 Analog Digital Converter

( $T_A = -40\text{ }^\circ\text{C}$  to  $+125\text{ }^\circ\text{C}$ ,  $3.0\text{ V} \leq \text{AVRH} - \text{AVRL}$ ,  $V_{CC} = \text{AV}_{CC} = 3.0\text{ V}$  to  $5.5\text{ V}$ ,  $V_{SS} = \text{AV}_{SS} = 0\text{ V}$ )

Parameter	Symbol	Pin	Value			Unit	Remarks
			Min	Typ	Max		
Resolution	-	-	-	-	10	bit	
Total error	-	-	-3	-	+3	LSB	
Nonlinearity error	-	-	-2.5	-	+2.5	LSB	
Differential nonlinearity error	-	-	-1.9	-	+1.9	LSB	
Zero reading voltage	$V_{OT}$	ANn	AVRL - 1.5 LSB	AVRL + 0.5 LSB	AVRL + 2.5 LSB	V	
Full scale reading voltage	$V_{FST}$	ANn	AVRH - 3.5 LSB	AVRH - 1.5 LSB	AVRH + 0.5 LSB	V	
Compare time	-	-	1.0	-	16,500	$\mu\text{s}$	$4.5\text{ V} \leq \text{AV}_{CC} \leq 5.5\text{ V}$
			2.0	-	-	$\mu\text{s}$	$3.0\text{ V} \leq \text{AV}_{CC} < 4.5\text{ V}$
Sampling time	-	-	0.5	-	-	$\mu\text{s}$	$4.5\text{ V} \leq \text{AV}_{CC} \leq 5.5\text{ V}$
			1.2	-	-	$\mu\text{s}$	$3.0\text{ V} \leq \text{AV}_{CC} < 4.5\text{ V}$
Analog port input current	$I_{AIN}$	ANn	-3	-	+3	$\mu\text{A}$	$\text{AV}_{SS}$ , $\text{AVRL} < V_I < \text{AV}_{CC}$ , AVRH
Analog port input current	$I_{AIN}$	ANn	-1	-	+1	$\mu\text{A}$	$T_A = 25\text{ }^\circ\text{C}$ , $\text{AV}_{SS}$ , $\text{AVRL} < V_I < \text{AV}_{CC}$ , AVRH
			-3	-	+3	$\mu\text{A}$	$T_A = 125\text{ }^\circ\text{C}$ , $\text{AV}_{SS}$ , $\text{AVRL} < V_I < \text{AV}_{CC}$ , AVRH
Analog input voltage range	$V_{AIN}$	ANn	AVRL	-	AVRH	V	
Reference voltage range	AVRH	AVRH	$0.75\text{ AV}_{CC}$	-	$\text{AV}_{CC}$	V	
	AVRL	AVRL	$\text{AV}_{SS}$	-	$0.25\text{ AV}_{CC}$	V	
Power supply current	$I_A$	$\text{AV}_{CC}$	-	2.5	5	mA	A/D Converter active
	$I_{AH}$	$\text{AV}_{CC}$	-	-	5	$\mu\text{A}$	A/D Converter not operated
Reference voltage current	$I_R$	AVRH/A VRL	-	0.7	1	mA	A/D Converter active
	$I_{RH}$	AVRH/A VRL	-	-	5	$\mu\text{A}$	A/D Converter not operated
Offset between input channels	-	ANn	-	-	4	LSB	

**Note:** The accuracy gets worse as  $|\text{AVRH} - \text{AVRL}|$  becomes smaller.

### 14.5.1 Definition of A/D Converter Terms

- **Resolution:** Analog variation that is recognized by an A/D converter.
- **Total error:** Difference between the actual value and the ideal value. The total error includes zero transition error, full-scale transition error and nonlinearity error.
- **Nonlinearity error:** Deviation between a line across zero-transition line (“00 0000 0000” <--> “00 0000 0001”) and full-scale transition line (“11 1111 1110” <--> “11 1111 1111”) and actual conversion characteristics.
- **Differential nonlinearity error:** Deviation of input voltage, which is required for changing output code by 1 LSB, from an ideal value.
- **Zero reading voltage:** Input voltage which results in the minimum conversion value.
- **Full scale reading voltage:** Input voltage which results in the maximum conversion value.

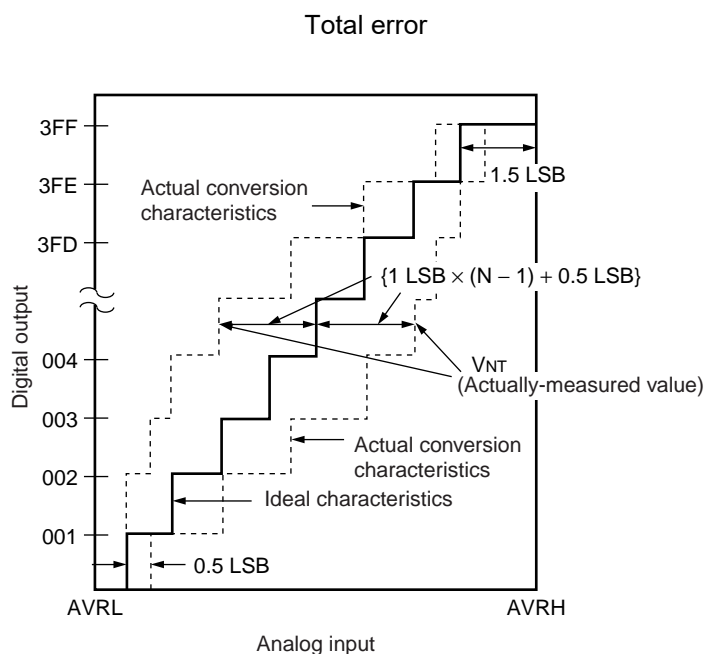

$$\text{Total error of digital output "N"} = \frac{V_{NT} - \{1 \text{ LSB} \times (N - 1) + 0.5 \text{ LSB}\}}{1 \text{ LSB}} \text{ [LSB]}$$

$$1 \text{ LSB} = (\text{Ideal value}) \frac{AVRH - AVRL}{1024} \text{ [V]}$$

N: A/D converter digital output value

$$V_{OT} (\text{Ideal value}) = AVRL + 0.5 \text{ LSB [V]}$$

$$V_{FST} (\text{Ideal value}) = AVRH - 1.5 \text{ LSB [V]}$$

$V_{NT}$ : A voltage at which digital output transitions from (N - 1) to N.

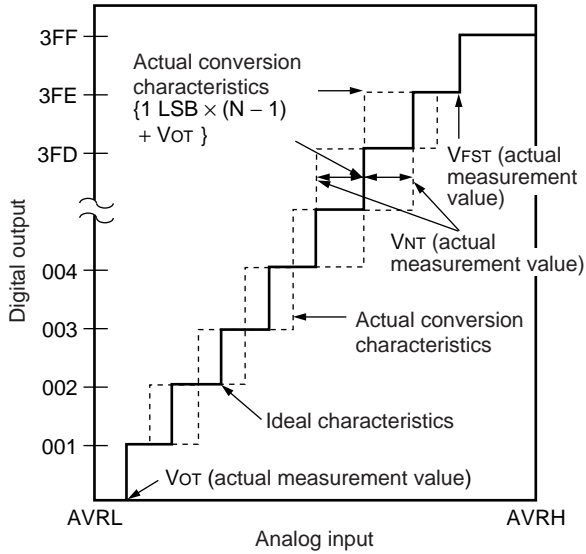
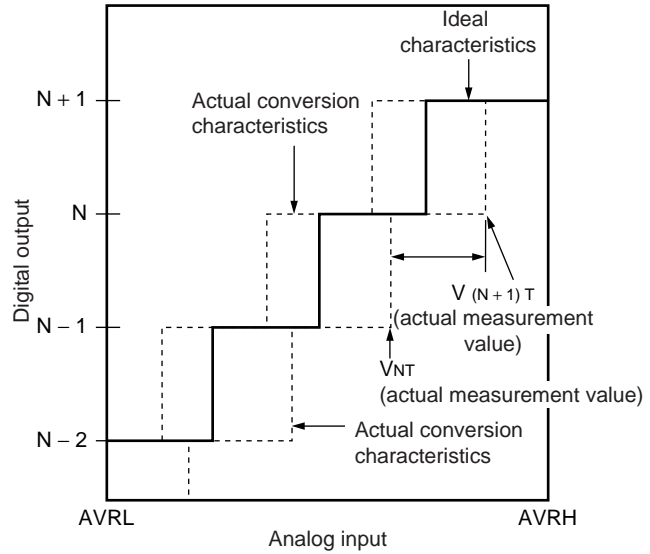
**Nonlinearity error**

**Differential nonlinearity error**

$$\text{Nonlinearity error of digital output } N = \frac{V_{NT} - \{1 \text{ LSB} \times (N - 1) + V_{OT}\}}{1 \text{ LSB}} \text{ [LSB]}$$

$$\text{Differential nonlinearity error of digital output } N = \frac{V_{(N+1)T} - V_{NT}}{1 \text{ LSB}} - 1 \text{ LSB [LSB]}$$

$$1 \text{ LSB} = \frac{V_{FST} - V_{OT}}{1022} \text{ [V]}$$

N: A/D converter digital output value

$V_{OT}$ : Voltage at which digital output transits from "000<sub>H</sub>" to "001<sub>H</sub>."

$V_{FST}$ : Voltage at which digital output transits from "3FE<sub>H</sub>" to "3FF<sub>H</sub>."

### 14.5.2 Notes on A/D Converter Section

- About the external impedance of the analog input and the sampling time of the A/D converter (with sample and hold circuit):

If the external impedance is too high to keep sufficient sampling time, the analog voltage charged to the internal sample and hold capacitor is insufficient, adversely affecting A/D conversion precision.

Analog Input Circuit Model:

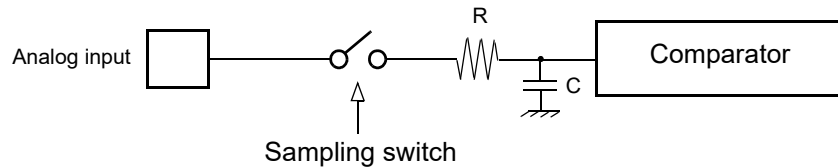

**Reference value:**

C = 8.5 pF (Max)

To satisfy the A/D conversion precision standard, the relationship between the external impedance and minimum sampling time must be considered and then either the resistor value and operating frequency must be adjusted or the external impedance must be decreased so that the sampling time ( $T_{\text{samp}}$ ) is longer than the minimum value. Usually, this value is set to  $7\tau$ , where  $\tau = RC$ . If the external input resistance ( $R_{\text{ext}}$ ) connected to the analog input is included, the sampling time is expressed as follows:

$$T_{\text{samp}} [\text{min}] = 7 \times (R_{\text{ext}} + 2.6 \text{ k}\Omega) \times C \text{ for } 4.5 \leq AV_{\text{CC}} \leq 5.5$$

$$T_{\text{samp}} [\text{min}] = 7 \times (R_{\text{ext}} + 12.1 \text{ k}\Omega) \times C \text{ for } 3.0 \leq AV_{\text{CC}} \leq 4.5$$

If the sampling time cannot be sufficient, connect a capacitor of about 0.1  $\mu\text{F}$  to the analog input pin.

- About the error

The accuracy gets worse as  $|AV_{\text{RH}} - AV_{\text{RL}}|$  becomes smaller.



## 14.6 Low Voltage Detector characteristics

( $T_A = -40\text{ }^{\circ}\text{C}$  to  $+125\text{ }^{\circ}\text{C}$ ,  $V_{CC} = AV_{CC} = 3.0\text{ V} - 5.5\text{ V}$ ,  $V_{SS} = AV_{SS} = 0\text{ V}$ )

Parameter	Symbol	Value		Unit	Remarks
		Min	Max		
Stabilization time	$T_{LVDSTAB}$	-	75	$\mu\text{s}$	After power-up or change of detection level
Level 0	$V_{DL0}$	2.7	2.9	V	CILCR:LVL[3:0]="0000"
Level 1	$V_{DL1}$	2.9	3.1	V	CILCR:LVL[3:0]="0001"
Level 2	$V_{DL2}$	3.1	3.3	V	CILCR:LVL[3:0]="0010"
Level 3	$V_{DL3}$	3.5	3.75	V	CILCR:LVL[3:0]="0011"
Level 4	$V_{DL4}$	3.6	3.85	V	CILCR:LVL[3:0]="0100"
Level 5	$V_{DL5}$	3.7	3.95	V	CILCR:LVL[3:0]="0101"
Level 6	$V_{DL6}$	3.8	4.05	V	CILCR:LVL[3:0]="0110"
Level 7	$V_{DL7}$	3.9	4.15	V	CILCR:LVL[3:0]="0111"
Level 8	$V_{DL8}$	4.0	4.25	V	CILCR:LVL[3:0]="1000"
Level 9	$V_{DL9}$	4.1	4.35	V	CILCR:LVL[3:0]="1001"
Level 10	$V_{DL10}$	not used			
Level 11	$V_{DL11}$	not used			
Level 12	$V_{DL12}$	not used			
Level 13	$V_{DL13}$	not used			
Level 14	$V_{DL14}$	not used			
Level 15	$V_{DL15}$	not used			

CILCR:LVL[3:0] are the low voltage detector level select bits of the CILCR register.

Levels 10 to 15 are not used in this device.

For correct detection, the slope of the voltage level must satisfy  $\left| \frac{dV}{dt} \right| \leq 0.004 \frac{\text{V}}{\mu\text{s}}$ .

Faster variations are regarded as noise and may not be detected.

The functional operation of the MCU is guaranteed down to the minimum low voltage detection level of  $V_{CC} = 2.7\text{ V}$ . The electrical characteristics however are only valid in the specified range (usually down to  $3.0\text{ V}$ ).

### 14.6.1 Low Voltage Detector Operation

In the following figure, the occurrence of a low voltage condition is illustrated. For a detailed description of the reset and startup behavior, please refer to the corresponding hardware manual chapter.

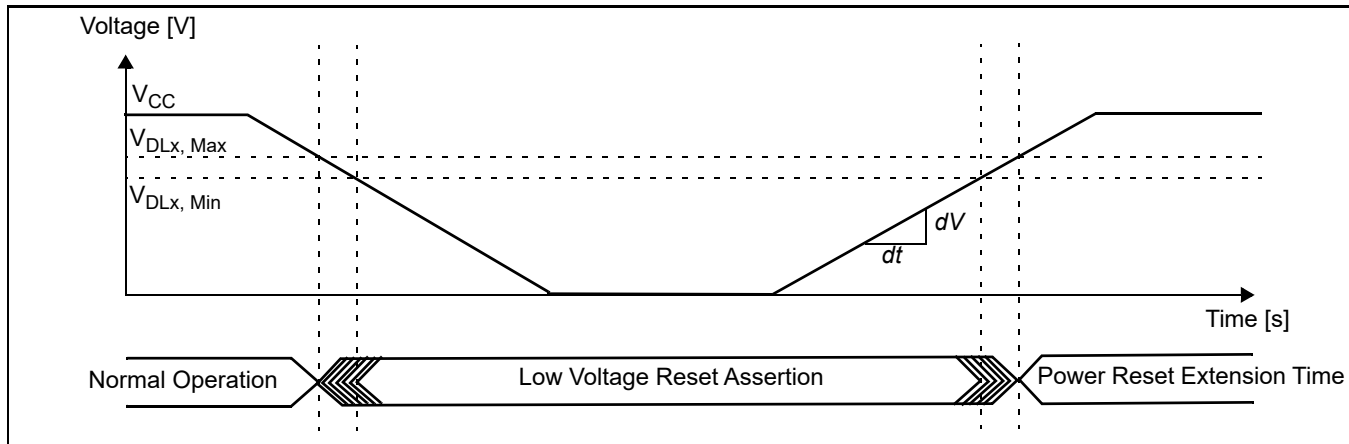

### 14.7 Flash Memory Program/Erase Characteristics

( $T_A = -40\text{ }^{\circ}\text{C}$  to  $105\text{ }^{\circ}\text{C}$ ,  $V_{CC} = AV_{CC} = 3.0\text{ V}$  to  $5.5\text{ V}$ ,  $V_{SS} = AV_{SS} = 0\text{ V}$ )

Parameter	Value			Unit	Remarks
	Min	Typ	Max		
Sector erase time	-	0.9	3.6	s	Without erasure pre-programming time
Chip erase time Program/Data Flash (Main Flash)	-	n*0.9	n*3.6	s	Without erasure pre-programming time (n is the number of Flash sector of the device)
Word (16-bit width) programming time Program/Data Flash (Main Flash)	-	23	370	$\mu\text{s}$	Without overhead time for submitting write command
Program/Erase cycle	10 000	-	-	cycle	100 000 Program/Erase cycles are under evaluation by Cypress Semiconductor
Flash data retention time	20	-	-	year	[1]

[1]: This value was converted from the results of evaluating the reliability of the technology (using Arrhenius equation to convert high temperature measurements into normalized value at  $85\text{ }^{\circ}\text{C}$ )

### 15. Example Characteristics

The diagrams below show the characteristics of one measured sample with typical process parameters.

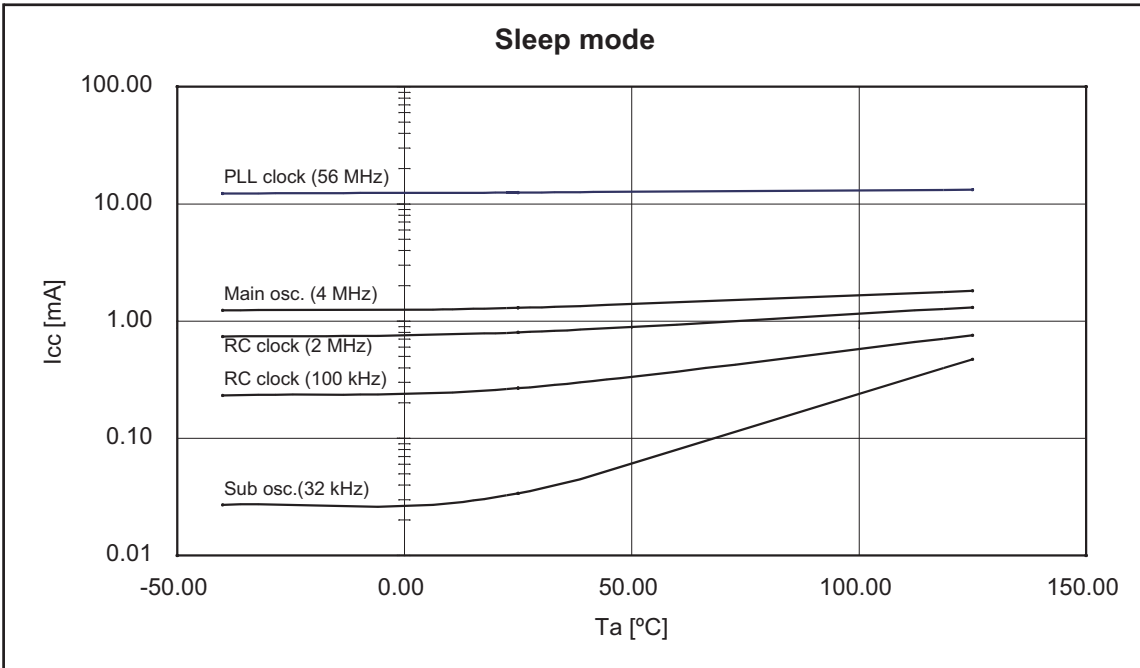
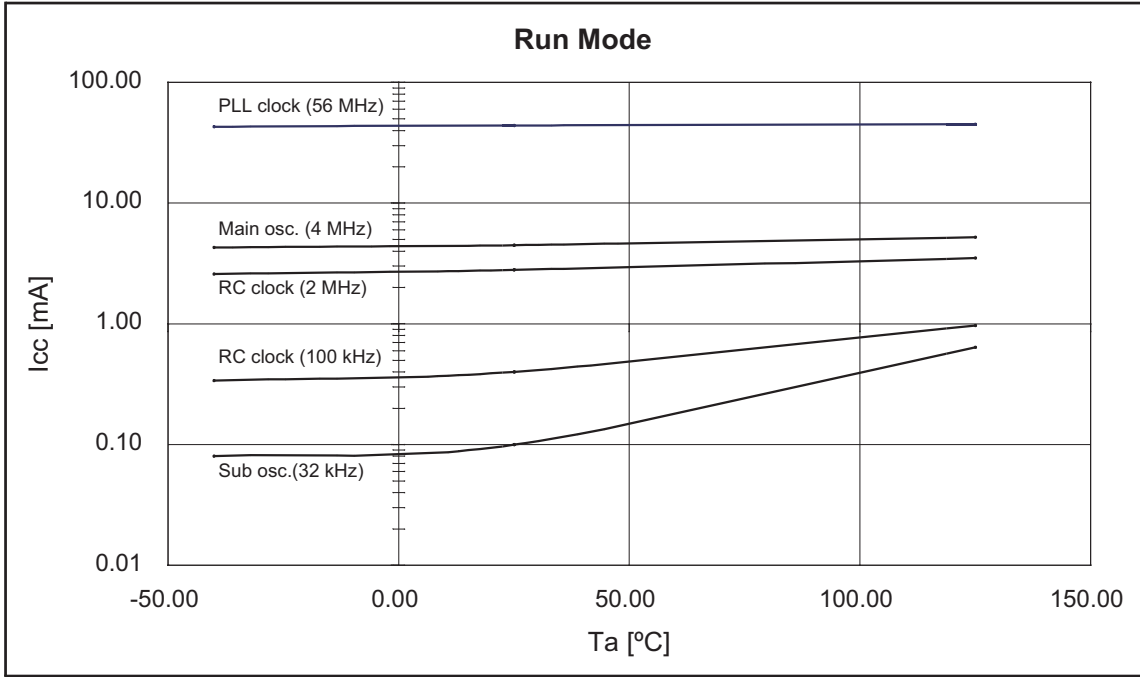

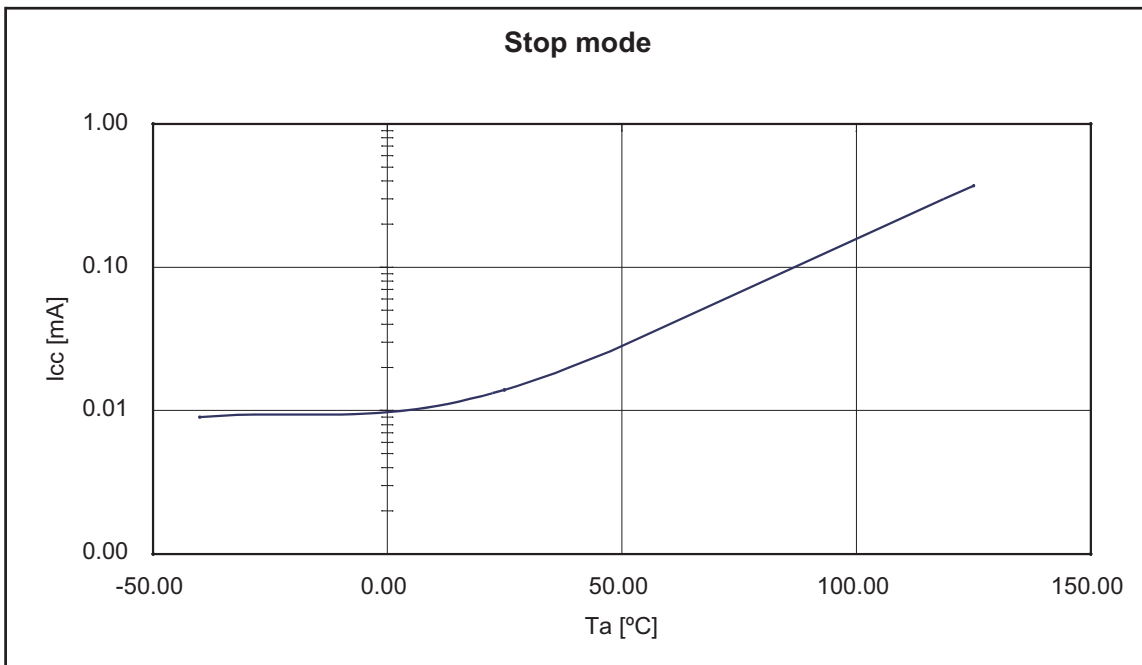
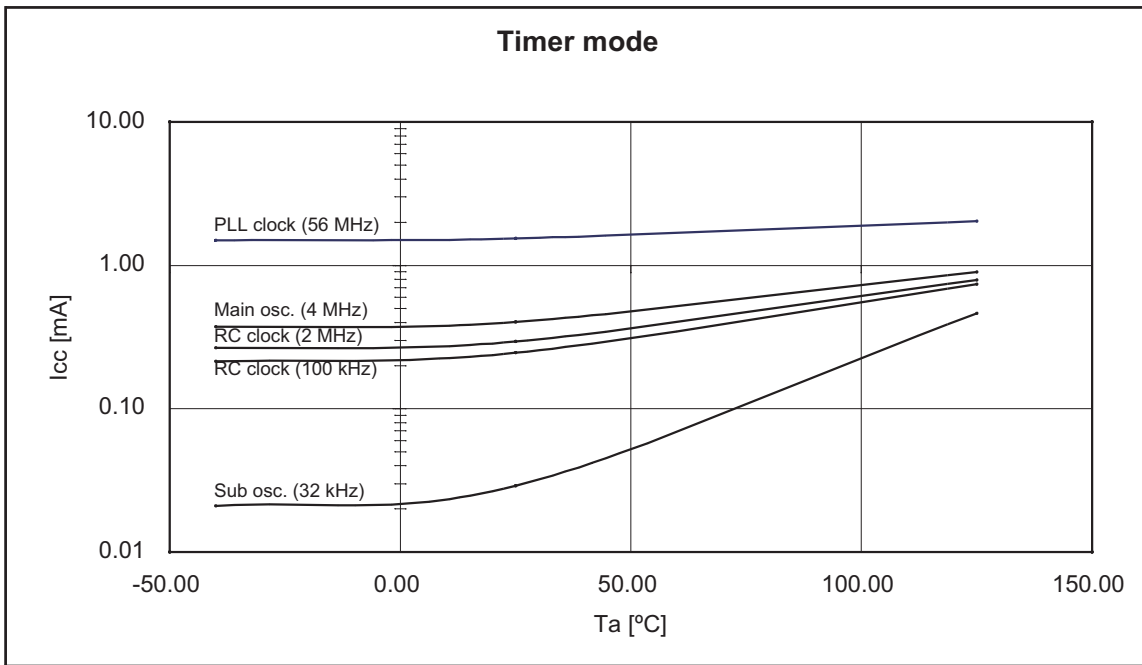

**Table 6: Used Settings**

Mode	Selected Source Clock	Clock/Regulator Settings
Run mode	PLL	CLKS1 = CLKS2 = CLKB = CLKP1 = 56 MHz CLKP2 = 28 MHz Regulator in High Power Mode Core Voltage = 1.9 V
	Main osc.	CLKS1 = CLKS2 = CLKB = CLKP1 = CLKP2 = 4 MHz Regulator in High Power Mode Core Voltage = 1.8 V
	RC clock fast	CLKS1 = CLKS2 = CLKB = CLKP1 = CLKP2 = 2 MHz Regulator in High Power Mode Core Voltage = 1.8 V
	RC clock slow	CLKS1 = CLKS2 = CLKB = CLKP1 = CLKP2 = 100 kHz Regulator in High Power Mode Core Voltage = 1.8 V
	Sub osc.	CLKS1 = CLKS2 = CLKB = CLKP1 = CLKP2 = 32 kHz Regulator in Low Power Mode A Core Voltage = 1.8 V
Sleep mode	PLL	CLKS1 = CLKS2 = CLKP1 = 56 MHz CLKP2 = 28 MHz (CLKB is stopped in this mode) Regulator in High Power Mode Core Voltage = 1.9 V
	Main osc.	CLKS1 = CLKS2 = CLKP1 = CLKP2 = 4 MHz (CLKB is stopped in this mode) Regulator in High Power Mode Core Voltage = 1.8 V
	RC clock fast	CLKS1 = CLKS2 = CLKP1 = CLKP2 = 2 MHz (CLKB is stopped in this mode) Regulator in High Power Mode Core Voltage = 1.8 V
	RC clock slow	CLKS1 = CLKS2 = CLKP1 = CLKP2 = 100 kHz (CLKB is stopped in this mode) Regulator in High Power Mode Core Voltage = 1.8 V
	Sub osc.	CLKS1 = CLKS2 = CLKP1 = CLKP2 = 32 kHz (CLKB is stopped in this mode) Regulator in Low Power Mode A Core Voltage = 1.8 V

**Table 6: Used Settings**

Mode	Selected Source Clock	Clock/Regulator Settings
Timer mode	PLL	CLKMC = 4 MHz, CLKPLL = 56 MHz (System clocks are stopped in this mode) Regulator in High Power Mode, Core Voltage = 1.9 V
	Main osc.	CLKMC = 4 MHz (System clocks are stopped in this mode) Regulator in High Power Mode, Core Voltage = 1.8 V
	RC clock fast	CLKRC = 2 MHz (System clocks are stopped in this mode) Regulator in High Power Mode, Core Voltage = 1.8 V
	RC clock slow	CLKRC = 100 kHz (System clocks are stopped in this mode) Regulator in High Power Mode, Core Voltage = 1.8 V
	Sub osc.	CLKSC = 100 kHz (System clocks are stopped in this mode) Regulator in Low Power Mode A, Core Voltage = 1.8 V
Stop mode	stopped	(All clocks are stopped in this mode) Regulator in Low Power Mode B, Core Voltage = 1.8 V

### 16. Package Dimension CY96(F)32x LQFP 80

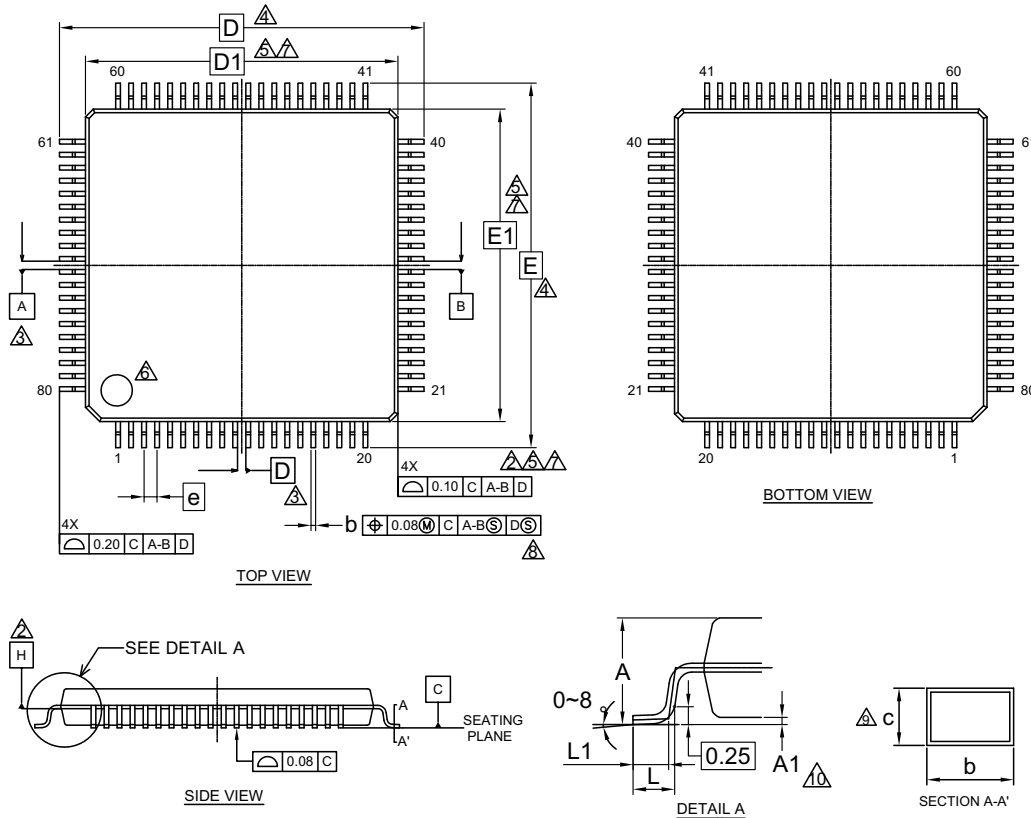

SYMBOL	DIMENSIONS		
	MIN.	NOM.	MAX.
A	—	—	1.70
A1	0.05	—	0.15
b	0.15	—	0.27
c	0.09	—	0.20
D	14.00 BSC.		
D1	12.00 BSC.		
e	0.50 BSC.		
E	14.00 BSC.		
E1	12.00 BSC.		
L	0.45	0.60	0.75
L1	0.30	0.50	0.70

**NOTES**

- CONTROLLING DIMENSIONS ARE IN MILLIMETERS (mm)
- DATUM PLANE H IS LOCATED AT THE BOTTOM OF THE MOLD PARTING LINE COINCIDENT WITH WHERE THE LEAD EXITS THE BODY.
- DATUMS A-B AND D TO BE DETERMINED AT DATUM PLANE H.
- TO BE DETERMINED AT SEATING PLANE C.
- DIMENSIONS D1 AND E1 DO NOT INCLUDE MOLD PROTRUSION. ALLOWABLE PROTRUSION IS 0.25mm PRE SIDE. DIMENSIONS D1 AND E1 INCLUDE MOLD MISMATCH AND ARE DETERMINED AT DATUM PLANE H.
- DETAILS OF PIN 1 IDENTIFIER ARE OPTIONAL BUT MUST BE LOCATED WITHIN THE ZONE INDICATED.
- REGARDLESS OF THE RELATIVE SIZE OF THE UPPER AND LOWER BODY SECTIONS. DIMENSIONS D1 AND E1 ARE DETERMINED AT THE LARGEST FEATURE OF THE BODY EXCLUSIVE OF MOLD FLASH AND GATE BURRS. BUT INCLUDING ANY MISMATCH BETWEEN THE UPPER AND LOWER SECTIONS OF THE MOLDER BODY.
- DIMENSION b DOES NOT INCLUDE DAMBER PROTRUSION. THE DAMBER PROTRUSION (S) SHALL NOT CAUSE THE LEAD WIDTH TO EXCEED b MAXIMUM BY MORE THAN 0.08mm. DAMBAR CANNOT BE LOCATED ON THE LOWER RADIUS OR THE LEAD FOOT.
- THESE DIMENSIONS APPLY TO THE FLAT SECTION OF THE LEAD BETWEEN 0.10mm AND 0.25mm FROM THE LEAD TIP.
- A1 IS DEFINED AS THE DISTANCE FROM THE SEATING PLANE TO THE LOWEST POINT OF THE PACKAGE BODY.

002-11501 \*\*

PACKAGE OUTLINE, 80 LEAD LQFP  
12.0X12.0X1.7 MM LQH080 Rev \*\*

## 17. Ordering Information

### 17.1 MCU with CAN Controller

Part Number	Flash/ROM	Subclock	Persistent Low Voltage Reset	Package
CY96F326RSBPMC-GS-UJE1	Flash A (288 KB)	No	No	80 pin Plastic LQFP (LQH080)
CY96F326RSBPMC-GS-UJE2				

**This datasheet is also valid for the following outdated devices:**

CY96F326YSA, CY96F326RSA, CY96F326YWA, CY96F326RWA, CY96F326ASA, CY96F326AWA



## 18. Revision History

Spanson Publication Number: **DS07-13804-2E**

Revision	Date	Modification
Prelim 1	2007-05-02	Creation
Prelim 2	2007-05-25	Electrical characteristics updates
Prelim 3	2007-11-23	Cover page: package description removed. Modification of the block diagram. Add A pin function group in pin function description. Electrical characteristics update. Add chapter on LVD and example characteristics. In ordering information: typo correction. Persistent instead of persistent. Memory map relaid out.
Prelim 4	2007-12-20	Update of the block diagram: external bus address lines, clock output function pins, AVRL removed from ADC block, relayout. RAMSIZE in RAMSTART table is corrected to 12kB as in described in the product lineup. IO map table updated Ordering information show now PMC packages not PQC. It displays also the redesigned release. IO map regenerated Memory map and Flash configuration reworked Few typos corrected across the document. Flash bank renaming. IO circuit drawings modified.
Prelim 5	2008-02-04	<ul style="list-style-type: none"> <li>■ Reload Timer RLT 6 for PPGs added</li> <li>■ Block diagram corrected: RLT6 added, OUT10-&gt;OUT10_R, TX0/RX0-&gt;RX2/RX2,</li> <li>■ Pin assignment: TX3 deleted</li> <li>■ Pin function description corrected with all existing pin types</li> <li>■ I/O circuit type diagrams corrected</li> <li>■ Memory map cleaned up</li> <li>■ "Flash sector configuration" replaced by corrected "User ROM Memory map for Flash devices"</li> <li>■ Parallel Flash programming spec removed</li> <li>■ IO map table regenerated: <ul style="list-style-type: none"> <li>□ Port register: Naming style corrected</li> <li>□ Memory control registers renamed (Main -&gt; A)</li> <li>□ addresses after 000BFFh removed</li> </ul> </li> <li>■ Handling devices: AD converter items added</li> <li>■ Absolute maximum ratings: Pd and Ta specified more precisely</li> <li>■ Run and Sleep mode currents: more conditions added (1WS settings)</li> <li>■ Run mode current spec in 48/24MHz mode corrected</li> <li>■ Maximum CLKS1 frequency corrected at 1.8V</li> <li>■ External bus timings: missing conditions added and readability improved</li> <li>■ Ordering information updated</li> <li>■ Typos and formatting corrected</li> </ul>

Revision	Date	Modification
6	2009-01-09	<ul style="list-style-type: none"> <li>■ Format adjusted to official Cypress datasheet standard (mainly style changes and official notes and disclaimer added)</li> <li>■ Numbering of Electrical Characteristics subchapters automated</li> <li>■ Devices added (MB96F326A)</li> <li>■ I/O map: Added note about reserved registers</li> <li>■ Serial programming interface: Note about handshaking pins improved</li> <li>■ specified AD converter channel offset to 4LSB</li> <li>■ package code of MB96V300 corrected in ordering information</li> <li>■ Added voltage condition to pull-up resistance spec</li> <li>■ Ordering information: column "Flash/ROM" added, column "Remarks" removed</li> <li>■ Official package dimension drawing with additional notes added</li> <li>■ Empty pages removed</li> <li>■ Handling devices: Notes added about Serial communication and about using ceramic resonators.</li> <li>■ Feature list and AC Characteristics: 16MHz maximum frequency is valid for crystal oscillators. For resonators, maximum frequency depends on Q-factor</li> <li>■ AC characteristics: PLL phase skew spec added, CLKVCO min=64MHz</li> <li>■ VOL3 spec improved: spec valid for 3mA load for full Vcc range</li> <li>■ C-Pin cap spec updated: 4.7µF-10µF capacitor with tolerance permitted</li> <li>■ "Preliminary" watermark removed</li> </ul>

Spansion Publication Number: DS07-13804-2E

Page	Section	Change Results
30	I/O Map	Corrected the wrong word in the column "Register" at address 000402 <sub>H</sub> . (stabilisation → stabilization)
79	Electrical Characteristics 14.5. Analog Digital Converter	Corrected the column "Value" and "Unit" of the parameter "Zero reading voltage" and "Full scale reading voltage". (Value : AVRL-1.5 → AVRL-1.5 LSB AVRL+0.5 → AVRL+0.5 LSB AVRL+2.5 → AVRL+2.5 LSB AVRH-3.5 → AVRH-3.5 LSB AVRH-1.5 → AVRH-1.5 LSB AVRH+0.5 → AVRH+0.5 LSB Unit: LSB → V )
89	Package Dimension MB96(F)32X LQFP 80	Added the following sentence under the figure; "Please confirm the latest Package dimension by following URL. <a href="http://edevice.fujitsu.com/package/en-search/">http://edevice.fujitsu.com/package/en-search/</a> "
91	Revision History	Corrected the wrong word in the column "Modification" of the revision "Prelim 3" and "Prelim 4". (Parsistant → Parsistent accross → across )
92		Corrected the wrong word in the column "Modification" of the revision "Prelim 6". (4.7 uF-10 uF → 4.7 µF-10 µF)

**NOTE: Please see "Document History" for later revised information.**

## 19. Major Changes in this Edition

Page	Section	Change Results
Rev.*B		
-	Marketing Part Numbers changed from an MB prefix to a CY prefix.	
4 7 10 86 87	1.Product Lineup 3.Pin Assignment 5.Pin Circuit Type 16.Package Dimension 17.Ordering Information	Package description modified to JEDEC description. (before) FPT-80P-M21 (after) LQH080
87	17.Ordering Information	<p>17.1 MCU without CAN Controller Deleted the following parts number: - MB96F326YSBPMC-GSE2 - MB96F326YWBPMC-CSE2 - MB96F326RWBPMC-GSE2 - MB96V300BRB-ES</p> <p>Changed the following part number: - MB96F326RSBPMC-GSE2 → CY96F326RSBPMC-GS-UJE2</p> <p>Added the following part number. - CY96F326RSBPMC-GS-UJE1</p> <p>17.2 MCU without CAN Controller Deleted this section.</p>

**Document History Page**

Document Title: CY96320 Series F <sup>2</sup> MC-16FX 16-bit Microcontroller Document Number: 002-04584				
Revision	ECN	Orig. of Change	Submission Date	Description of Change
**	–	AKIH	06/26/2009	Migrated to Cypress and assigned document number 002-04584. No change to document contents or format.
*A	5200652	KSUN	04/25/2016	Updated to Cypress template.
*B	6175336	SHUS	05/15/2018	Revised the following items: Marketing Part Numbers changed from an MB prefix to a CY prefix. 1.Product Lineup 3.Pin Assignments 5.Pin Circuit Type 16.Package Dimension 17.Ordering Information For details, please see 19.Major Changes in this Edition.
*C	6580866	KSUN	05/24/2019	Updated to new template.

## Sales, Solutions, and Legal Information

### Worldwide Sales and Design Support

Cypress maintains a worldwide network of offices, solution centers, manufacturer's representatives, and distributors. To find the office closest to you, visit us at [Cypress Locations](#).

#### Products

Arm® Cortex® Microcontrollers	<a href="http://cypress.com/arm">cypress.com/arm</a>
Automotive	<a href="http://cypress.com/automotive">cypress.com/automotive</a>
Clocks & Buffers	<a href="http://cypress.com/clocks">cypress.com/clocks</a>
Interface	<a href="http://cypress.com/interface">cypress.com/interface</a>
Internet of Things	<a href="http://cypress.com/iot">cypress.com/iot</a>
Memory	<a href="http://cypress.com/memory">cypress.com/memory</a>
Microcontrollers	<a href="http://cypress.com/mcu">cypress.com/mcu</a>
PSoC	<a href="http://cypress.com/psoc">cypress.com/psoc</a>
Power Management ICs	<a href="http://cypress.com/pmic">cypress.com/pmic</a>
Touch Sensing	<a href="http://cypress.com/touch">cypress.com/touch</a>
USB Controllers	<a href="http://cypress.com/usb">cypress.com/usb</a>
Wireless Connectivity	<a href="http://cypress.com/wireless">cypress.com/wireless</a>

#### PSoC® Solutions

[PSoC 1](#) | [PSoC 3](#) | [PSoC 4](#) | [PSoC 5LP](#) | [PSoC 6 MCU](#)

#### Cypress Developer Community

[Community](#) | [Projects](#) | [Video](#) | [Blogs](#) | [Training](#) | [Components](#)

#### Technical Support

[cypress.com/support](http://cypress.com/support)

© Cypress Semiconductor Corporation, 2009–2019. This document is the property of Cypress Semiconductor Corporation and its subsidiaries ("Cypress"). This document, including any software or firmware included or referenced in this document ("Software"), is owned by Cypress under the intellectual property laws and treaties of the United States and other countries worldwide. Cypress reserves all rights under such laws and treaties and does not, except as specifically stated in this paragraph, grant any license under its patents, copyrights, trademarks, or other intellectual property rights. If the Software is not accompanied by a license agreement and you do not otherwise have a written agreement with Cypress governing the use of the Software, then Cypress hereby grants you a personal, non-exclusive, nontransferable license (without the right to sublicense) (1) under its copyright rights in the Software (a) for Software provided in source code form, to modify and reproduce the Software solely for use with Cypress hardware products, only internally within your organization, and (b) to distribute the Software in binary code form externally to end users (either directly or indirectly through resellers and distributors), solely for use on Cypress hardware product units, and (2) under those claims of Cypress's patents that are infringed by the Software (as provided by Cypress, unmodified) to make, use, distribute, and import the Software solely for use with Cypress hardware products. Any other use, reproduction, modification, translation, or compilation of the Software is prohibited.

TO THE EXTENT PERMITTED BY APPLICABLE LAW, CYPRESS MAKES NO WARRANTY OF ANY KIND, EXPRESS OR IMPLIED, WITH REGARD TO THIS DOCUMENT OR ANY SOFTWARE OR ACCOMPANYING HARDWARE, INCLUDING, BUT NOT LIMITED TO, THE IMPLIED WARRANTIES OF MERCHANTABILITY AND FITNESS FOR A PARTICULAR PURPOSE. No computing device can be absolutely secure. Therefore, despite security measures implemented in Cypress hardware or software products, Cypress shall have no liability arising out of any security breach, such as unauthorized access to or use of a Cypress product. CYPRESS DOES NOT REPRESENT, WARRANT, OR GUARANTEE THAT CYPRESS PRODUCTS, OR SYSTEMS CREATED USING CYPRESS PRODUCTS, WILL BE FREE FROM CORRUPTION, ATTACK, VIRUSES, INTERFERENCE, HACKING, DATA LOSS OR THEFT, OR OTHER SECURITY INTRUSION (collectively, "Security Breach"). Cypress disclaims any liability relating to any Security Breach, and you shall and hereby do release Cypress from any claim, damage, or other liability arising from any Security Breach. In addition, the products described in these materials may contain design defects or errors known as errata which may cause the product to deviate from published specifications. To the extent permitted by applicable law, Cypress reserves the right to make changes to this document without further notice. Cypress does not assume any liability arising out of the application or use of any product or circuit described in this document. Any information provided in this document, including any sample design information or programming code, is provided only for reference purposes. It is the responsibility of the user of this document to properly design, program, and test the functionality and safety of any application made of this information and any resulting product. "High-Risk Device" means any device or system whose failure could cause personal injury, death, or property damage. Examples of High-Risk Devices are weapons, nuclear installations, surgical implants, and other medical devices. "Critical Component" means any component of a High-Risk Device whose failure to perform can be reasonably expected to cause, directly or indirectly, the failure of the High-Risk Device, or to affect its safety or effectiveness. Cypress is not liable, in whole or in part, and you shall and hereby do release Cypress from any claim, damage, or other liability arising from any use of a Cypress product as a Critical Component in a High-Risk Device. You shall indemnify and hold Cypress, its directors, officers, employees, agents, affiliates, distributors, and assigns harmless from and against all claims, costs, damages, and expenses, arising out of any claim, including claims for product liability, personal injury or death, or property damage arising from any use of a Cypress product as a Critical Component in a High-Risk Device. Cypress products are not intended or authorized for use as a Critical Component in any High-Risk Device except to the limited extent that (i) Cypress's published data sheet for the product explicitly states Cypress has qualified the product for use in a specific High-Risk Device, or (ii) Cypress has given you advance written authorization to use the product as a Critical Component in the specific High-Risk Device and you have signed a separate indemnification agreement.

Cypress, the Cypress logo, Spansion, the Spansion logo, and combinations thereof, WICED, PSoC, CapSense, EZ-USB, F-RAM, and Traveo are trademarks or registered trademarks of Cypress in the United States and other countries. For a more complete list of Cypress trademarks, visit [cypress.com](http://cypress.com). Other names and brands may be claimed as property of their respective owners.