

Peak Atlas *DCA Pro*

*Advanced Semiconductor Component Analyser
with Graphics Display and PC connectivity
Model DCA75*

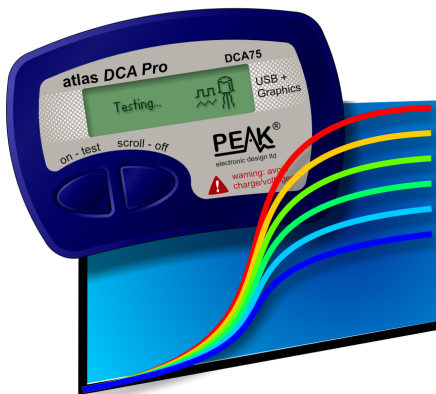

Designed and manufactured with pride in the UK

User Guide

© Peak Electronic Design Limited 2012/2019

In the interests of development, information in this guide is subject to change without notice - E&OE



Want to use it now?

We understand that you want to use your *Peak Atlas DCA Pro* right now. The unit is ready to go and you should have little need to refer to this user guide, but please make sure that you do at least take a look at the notices on page 5.

Contents	Page
Introduction	4
Important Considerations	5
Analysing Semiconductors - Standalone mode	6
Diodes	8
Zener Diodes	9
Diode Networks	10
LEDs	11
Bicolour LEDs (2-lead types)	12
Bicolour LEDs (3-lead types)	13
Bipolar Junction Transistors (BJTs).....	14
Darlington Transistors.....	18
Digital Transistors	21
Enhancement Mode MOSFETs	22
Depletion Mode MOSFETs	23
Enhancement Mode IGBTs.....	24
Depletion Mode IGBTs.....	25
Junction FETs (JFETs).....	26
Thyristors (SCRs) and Triacs.....	28
Voltage Regulators.....	29

Contents continued on next page...

Contents (continued)	Page
PC Software Installation	30
Windows XP Installation	31
Windows Vista, 7, 8 and 10 Installation	32
Running the DCA Pro software for the first time	33
Analysing Semiconductors – PC mode	34
PC mode - Curve Tracing functions.....	35
PC mode - Exporting your data.....	36
PC mode - Special functions	37
Audible Settings	38
Care of your Peak Atlas DCA Pro	39
Appendix A - Troubleshooting.....	40
Appendix B - General Technical Specifications	41
Appendix C - Component Testing Specifications	42
Appendix D - Analysis test circuits.....	44
Transistor test circuit.....	44
JFET/MOSFET/IGBT test circuit.....	45
Diode test circuit	46
Voltage regulator test circuit.....	47
Appendix E - Warranty Information	48
Appendix F - Disposal information.....	48

Introduction

The *Peak Atlas DCA Pro* is an advanced semiconductor analyser that combines simplicity, ease of use and a range of advanced features. You can use your *DCA Pro* on its own or in combination with a laptop or desktop PC.

Summary Features:

- Automatic component type identification and schematic display:
 - Bipolar transistors, Darlington transistors and Digital transistors.
 - Enhancement Mode and Depletion Mode MOSFETs.
 - Enhancement Mode and Depletion Mode IGBTs.
 - Junction FETs (including SiC normally off types).
 - Low power sensitive Triacs and Thyristors.
 - Light Emitting Diodes including Bicolour LEDs (2 and 3 leads).
 - Diodes and Diode networks.
 - Zener diodes (<~11V).
 - Voltage regulators (<~8V).
- Automatic pinout identification, just connect any way round.
- Special feature identification such as free-wheeling diodes and resistor shunts.
- Gain measurement for bipolar transistors.
- Leakage current measurement for bipolar transistors.
- Silicon and Germanium detection for bipolar transistors.
- Gate threshold and transconductance measurement for MOSFETs, JFETs and IGBTs.
- Semiconductor forward voltage measurement for diodes, LEDs and transistor Base-Emitter junctions.
- Zener voltage measurement.
- Voltage regulator drop-out measurement.
- PC connectivity providing:
 - Larger component identification display.
 - Detailed characteristics measurement.
 - Curve tracing functions.
- Single alkaline AAA battery (not used when USB connected).
- Automatic and manual power-off.

Important Considerations

Please observe the following guidelines:

- This instrument must NEVER be connected to powered equipment/components or equipment/components with any stored energy (e.g. charged capacitors). Failure to comply with this warning may result in personal injury, damage to the equipment under test, damage to your *DCA Pro* and invalidation of the manufacturer's warranty.
- The *DCA Pro* is designed to analyse semiconductors that are not in-circuit, otherwise complex circuit effects will result in erroneous measurements.
- Large voltage differences between true earth and your PC's USB port can result in damage. The device under test should therefore have no path to earth or other supplies.
- Avoid rough treatment, hard knocks and extreme temperatures.
- This unit is not waterproof.
- Only use a good quality AAA Alkaline, NiMh or Lithium-Iron-Disulphide cell. Input supply rated up to 1.9V.

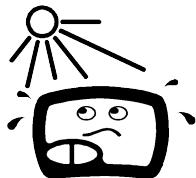

Analysing Semiconductors – Standalone mode

The *DCA Pro* is designed to analyse discrete, unconnected, unpowered components.

This ensures that external connections don't influence the measured parameters. The three test probes can be connected to the component any way round.

If the component has only two terminals, then any pair of the three test probes can be used.

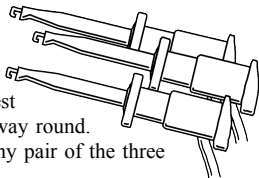

The *DCA Pro* will start component analysis when the **on-test** button is pressed.



For the first analysis, the tests are performed while displaying the Peak logo (no time is wasted while displaying the logo).

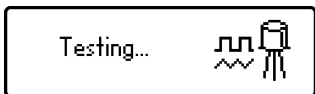

For subsequent testing when the unit is already powered-up, the unit displays the "Testing..." screen.

Depending on the component type, analysis may take a few seconds to complete, after which, the results of the analysis are displayed.

Information is displayed a "page" at a time, each page can be smoothly scrolled by briefly pressing the **scroll-off** button.



Although the *DCA Pro* will switch itself off if left unattended, you can manually switch the unit off by holding down the **scroll-off** button for a couple of seconds.

If the *DCA Pro* cannot detect any supported component between any of the test probes, the following message will be displayed:

No component
detected.



If the component is not a supported component type, a faulty component or a component that is being tested in-circuit, the analysis may result in the following message being displayed:

Unknown/faulty
component.



Some components may be faulty due to a shorted junction between a pair of the probes. If this is the case, the following message (or similar) will be displayed:

Red & Blue
leads shorted.



If all three probes are shorted (or very low resistance) then the following message will be displayed:

Red, Green & Blue
leads shorted.



It is possible that the *DCA Pro* may detect one or more diode junctions or other component type within an unknown or faulty part. This is because many semiconductors comprise of PN (diode) junctions. Please refer to the section on diodes and diode networks for more information.

Diodes

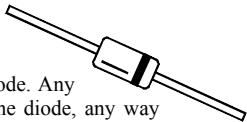

The *DCA Pro* will analyse almost any type of diode. Any pair of the three test clips can be connected to the diode, any way round. If the unit detects a single diode, a message similar to the following will be displayed:

Diode junction
Green-K Blue-A
VF=0.694V at 5.00mA



In this example, the Cathode (symbol of K) is connected to the Green test clip and the Anode (symbol of A) is connected to the Blue test clip,

additionally, the Red test clip is unconnected.

The forward voltage drop is also displayed; this gives an indication of the diode technology. In this example, it is likely that the diode is a standard silicon diode. A germanium or Schottky diode may yield a forward voltage of about 0.25V. The current at which the diode was tested is also displayed. Unlike most multimeters that don't have a defined diode test current, the *DCA Pro* typically tests diodes (PN junctions) at a forward current of 5mA. You can test at different currents by performing an I/V graph using the PC software.



Note that the *DCA Pro* will detect only one diode even if two diodes are connected in series when the third test clip is not connected to the junction between the diodes. The forward voltage drop displayed however will be the voltage across the whole series combination.



The *DCA Pro* will determine that the diode(s) under test is an LED if the measured forward voltage drop exceeds 1.50V. This has no effect on the readings displayed other than the LED message instead of Diode message. Please refer to the section on LED analysis for more information.

Zener Diodes

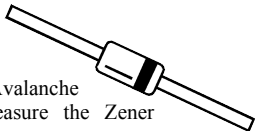

The *DCA Pro* supports Zener diodes (and Avalanche diodes). Additionally, the instrument can measure the Zener voltage*.

Connect any pair of the 3 test leads to the Zener diode. Following analysis, the component details are displayed.

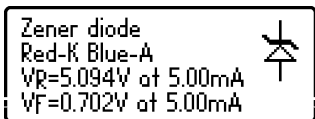

In this example, a Zener diode with a reverse voltage (Zener voltage) of nearly 5.1V has been detected. Additionally, the forward biased voltage characteristic is measured, 0.702V at 5mA for this example.

The *DCA Pro* attempts to test the Zener diode with a current of nominally 5mA. For Zener diodes with a Zener voltage of more than about 7V, a lower test current of 2mA or 1mA will be used. This is illustrated in the following graph:

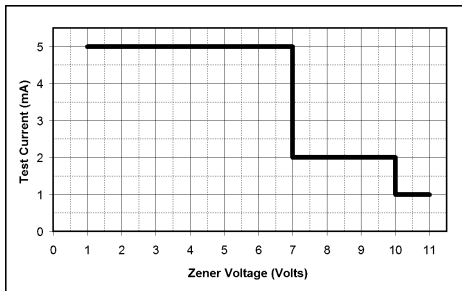

*The *DCA Pro* may not be able to identify Zener diodes with a Zener voltage of more than 11V. It will however still identify the diode junction in its forward biased mode.

Diode Networks

The *DCA Pro* will identify multiple diode junctions between the probes. For three terminal devices such as SOT-23 diode networks, all three test clips must be connected. The optional Peak Component Adapter for SOT-23 parts (Peak model PCA23) can be useful for testing SOT-23 parts.

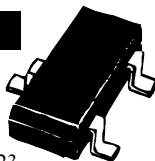

The instrument will describe the type of diode network as text and as a component schematic symbol. Types of diode network supported include: **Series pair**, **Common Cathode** and **Common Anode**.

It will then show the pinout and the V_F specs for each diode in turn.

2 diode junctions	
Series pair	
#1: Diode junction	
Green-K Blue-A	
$V_F=0.703V$ at 5.00mA	
#2: Diode junction	
Red-A Blue-K	
$V_F=0.699V$ at 5.00mA	

It can be seen in this example, that the blue test clip is connected to both the anode on Diode #1 and to the cathode of Diode #2. This means that the two diodes are effectively connected in series, with the blue clip at the mid point.

This example is illustrated below:

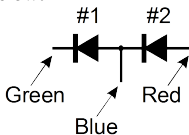

In the same way as the single diode analysis, the forward voltage for each diode is measured for a nominal test current of 5mA.

LEDs

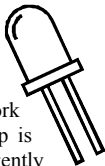

An LED (light emitting diode) is really just another type of diode, however, the *DCA Pro* will determine that an LED or LED network has been detected if the diode's measured forward voltage drop is between 1.5V and 4.0V. This also enables the *DCA Pro* to intelligently identify bicolour LEDs, both two-lead and three-lead varieties. See the section on bicolour LEDs for more information.

For two leaded parts, connect any pair of the 3 test clips to your LED. Leave the 3rd test clip unconnected.

In this example, the Red test clip is connected to the LED's Cathode (negative) and the Blue test clip is connected to the Anode (positive).

LED Red-K Blue-A VF=1.962V at 5.00mA	
--	--

The forward voltage of the LED is measured at a nominal current of 5mA. You can test at different currents by performing an I/V graph with the PC software.

During the analysis process, the LED will briefly illuminate (so you can see its illumination colour). The test current of 5mA (and the short pulse duration) means that it may not be as bright as you expect, LEDs are often used at currents of 10-20mA. Power LEDs are sometimes driven at 350mA or more.

Infra-red LEDs (including LEDs used in opto-isolators can have typical forward voltages of less than 1.5V at 5mA. This means that the *DCA Pro* will identify the device as a diode (instead of an LED). That is normal and does not indicate a fault. The pinout, forward voltage and test current values displayed are correct.

Bicolour LEDs (2-lead types)



Bicolour LEDs are generally available in two main varieties; 2-lead and 3-lead types.

This section describes the testing of 2-lead bicolour LEDs. These types are internally connected in inverse-parallel (back-to-back).

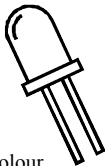

Similar to the diode network analysis, each LED within the bicolour LED is detailed in turn.

This example shows that LED #1 has its Cathode connected to the Red test clip and its Anode connected to the Blue test clip. The forward bias characteristic is shown for LED#1, 1.823V at 5mA in this example.

Pressing **scroll-off** then shows the details for the 2nd LED in the bicolour LED package.

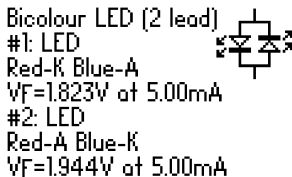

As expected for 2-lead bicolour LEDs, we can see in this example that LED#2 has its connections in exactly the opposite configuration to LED#1.



Note that it is common for the two LEDs within a bicolour LED to have different forward voltage characteristics. Red is often the lowest forward voltage, progressing through amber, yellow, yellow-green, pure-green and then blue (or white) with the highest forward voltage. **See the table at the bottom of the next page.**

Bicolour LEDs (3-lead types)

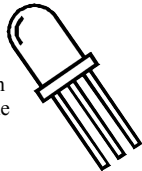

3-lead bicolour LEDs are available in common cathode and common anode varieties. The *DCA Pro* supports both types.



In the same way as the 2-lead bicolour LED analysis, each internal LED is detailed separately on the *DCA Pro* screen.

The type of bicolour LED is shown here, in this example we have a common cathode variety.

The pinout and V_F specs for each internal LED are then shown.

It can be seen here that our example has its common cathode terminal connected to the Green test clip.

Bicolour LED (3 lead)
Common Cathode
#1: LED
Red-A Green-K
 $V_F=1.935V$ at 5.00mA
#2: LED
Green-K Blue-A
 $V_F=1.877V$ at 5.00mA



Typical values of forward voltage for LED colours are shown here:
(LED types/manufacturers will vary significantly)

LED Colour	Typical V_F @ 5mA
Red	1.81V
Amber	1.86V
Yellow	1.90V
Yellow-Green (standard type)	1.95V
Pure-Green (emerald)	2.84V
Blue (and white)	2.95V

Bipolar Junction Transistors (BJTs)

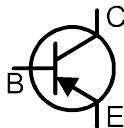

Bipolar Junction Transistors are simply “conventional” transistors, although variants of these do exist such as Darlington, devices with free-wheeling diodes, resistor shunted types and combinations of these types. All of these variations are automatically identified by the *DCA Pro* and their schematic symbol is displayed on the screen. Both NPN and PNP types are supported.

The 3 test clips can be applied to the transistor in any configuration.

As an example, testing a common PNP transistor such as the 2N5401 will result in a display similar to this:

This example shows that the Red test clip is connected to the Emitter, the Green is connected to the Base and the Blue test clip is connected to the Collector.

Pressing **scroll-off** allows further details to be displayed.

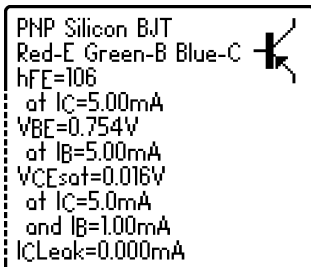

The DC current gain (h_{FE}), base emitter voltage drop (V_{BE}), collector saturation voltage (V_{CEsat}) and collector leakage current (I_{CLeak}) are all shown along with their test conditions.

Refer to the following sections for more details on some of these measurements.

Current Gain (h_{FE})

DC current gain (h_{FE}) is the ratio of the collector current (less leakage) to the base current for a particular operating condition.

The **DCA Pro** measures h_{FE} at a collector current of nominally 5.0mA and a collector-emitter voltage of between 3V and 9V.

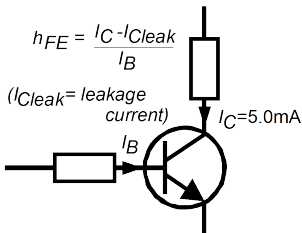

$h_{FE} = 167$
 at $I_C = 5.00\text{mA}$



The gain of all transistors can vary considerably with collector current, collector voltage and also temperature. The displayed value for gain therefore may not represent the gain experienced at other collector currents and voltages. This is particularly true for large devices. The displayed value of gain is very useful however for comparing transistors of a similar type for the purposes of gain matching or fault finding.

Darlington transistors can have very high gain values and more variation of gain will be evident as a result of this.



The current gain of transistor (particularly germanium types) can vary a large amount with changes in temperature. Even the warmth from your fingers can alter the gain of a device. It's best to let the temperature of the device stabilise for a minute or two before measuring the gain.



It is normal for transistors of the same type to have a wide range of gain values. For this reason, transistor circuits are often designed so that their operation has little dependence on the absolute value of current gain.

Base-Emitter Voltage Drop

The DC characteristics of the base-emitter junction are displayed, both the base-emitter forward voltage drop (V_{BE}) and the base current (I_B) used for that measurement.

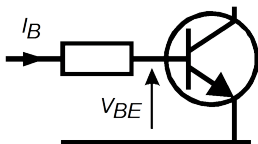

$V_{BE}=0.703V$
at $I_B=5.00mA$



This example shows an NPN base-emitter voltage (V_{BE}) of 0.703V for a base test current (I_B) of 5mA. If you wish, you can test the base-emitter junction at different currents by performing a PN junction I/V graph using the PC software.

The forward base-emitter voltage drop can aid in the identification of silicon or germanium devices. Germanium devices can have base-emitter voltages as low as 0.2V, Silicon types exhibit readings of about 0.7V and Darlington transistors can exhibit readings of about 1.2V because of the multiple base-emitter junctions being measured.



The *DCA Pro* uses the V_{BE} value to help it determine if your transistor is Silicon or Germanium. There can be considerable overlap in V_{BE} readings for Silicon and Germanium transistors. Don't worry if the decision is incorrect, it does not indicate a fault and no displayed measurements are affected by the Silicon/Germanium decision.



It is important to note that the *DCA Pro* does not perform the base-emitter voltage drop tests at the same base current as that used for the current gain measurement. V_{BE} is measured at a fixed base current of nominally 5mA. The base current used during the gain measurement is equal to I_C/h_{FE} .

Collector Leakage Current

The collector current that takes place when no base current is flowing is referred to as *Leakage Current*.

Most modern transistors exhibit extremely low values of leakage current, even for very high collector-emitter voltages.

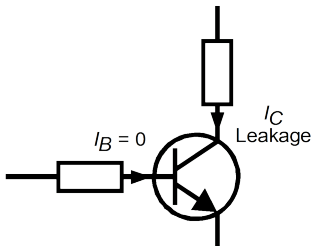

$I_{CLeak} = 0.177\text{mA}$



Older Germanium types however can suffer from significant collector leakage current, particular at high temperatures (leakage current is very temperature dependent).

Leakage current is automatically taken into account for the gain measurement (unlike many multimeters' gain measurement that can be fooled by leakage current).



If your transistor is a Silicon type, you should expect to see a leakage current of close to 0.000mA unless the transistor is faulty. Values less than 10 μ A are not displayed due to resolution limits.



The leakage current of germanium transistors can vary a large amount with changes in temperature (roughly doubling with every 5 $^{\circ}$ C increase). Even the warmth from your fingers can significantly alter the leakage current of a germanium device. Conversely, a cooling transistor (after a little handling) can result in a falling leakage current measurement over the period of a few seconds/minutes. This is completely normal.

Darlington Transistors

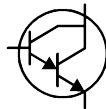

If the device is a Darlington transistor (two BJTs connected together), the unit will display a similar message to this:

```
NPN Darlington BJT
Red-B Green-E Blue-C
hFE=9410
```



Darlington devices that do not have internal resistors can exhibit very high gain (h_{FE}).

```
NPN Darlington BJT
Red-C Green-E Blue-B
hFE=67
```



This second example (left) shows the display for a Darlington transistor that has internal resistors connected to the base-emitter connections. This causes the h_{FE} measurement to become much

lower at the test currents used by the *DCA Pro*. This is normal and is not a fault with the transistor or the *DCA Pro*.



It is important to note that if a Darlington does contain a base-emitter shunt resistor network, any measurements of current gain (h_{FE}) will be very low at the test currents used by the *DCA Pro*. This is due to the resistors providing an additional path for the base current. The readings for gain however can still be used for comparing transistors of a similar type for the purposes of matching or gain band selecting.



Note that the *DCA Pro* will determine that the transistor under test is a Darlington type if the base-emitter voltage drop at 5mA is greater than 1.00V for devices with a base-emitter shunt resistance of greater than 60k Ω or if the base-emitter voltage drop is greater than 0.80V for devices with a base-emitter shunt resistance of less than 60k Ω .

Free Wheeling Diode

Some transistors, particularly CRT deflection transistors and many large Darlingtontons have a protection diode (“free wheeling diode” or “body diode”) inside their package connected between the collector and emitter.



If a free-wheeling diode has been detected, it is shown on the schematic symbol. Some examples are shown here:

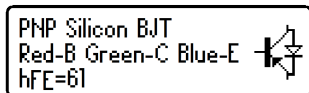

The Philips BU505DF is a typical example of a diode protected bipolar transistor. Remember that the diode (if present) is always internally connected between the collector and the emitter so that it is normally reverse biased.

For NPN transistors, the anode of the diode is connected to the emitter of the transistor. For PNP transistors, the anode of the diode is connected to the collector of the transistor.

Faulty or Very Low Gain Transistors

Faulty transistors that exhibit very low gain may cause the *DCA Pro* to only identify one or more diode junctions within the device. This is because NPN transistors consist of a structure of junctions that behave like a common anode diode network. PNP transistors can appear to be common cathode diode networks. The common junction represents the base terminal. This is normal for situations where the current gain is so low that it is immeasurable at the test currents used by the *DCA Pro*.

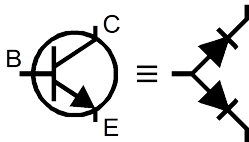

Please note that the equivalent diode pattern may not be correctly identified by the *DCA Pro* if your transistor is a Darlington type or has additional diode(s) in its package (such as a collector-emitter protection diode). This is due to the multiple PN junctions and current paths that cannot be uniquely resolved.

In some circumstances, the unit may not be able to deduce anything sensible from the device at all, in which case you may see one of these messages:

No component
detected.



Unknown/faulty
component.



Digital transistors

Digital transistors aren't really digital, they can act in both a linear or fully on/off mode. They're called "digital transistors" because they can be driven directly by digital outputs without the need for base current limiting resistors.

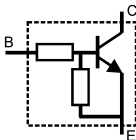

These transistors are usually found in surface mount packages and are becoming more common, particularly in mass produced electronic products.

These devices are generally intended to be used with logic level signals (3V or 5V typically), as such the gain of the device is rarely of concern.

The *DCA Pro* will identify the pinout, the raw current gain and the voltage thresholds for turning the transistor on or off.

Additionally, using V/I slope analysis, the *DCA Pro* will estimate the values of the internal resistors.

The internal resistors are typically in the range of 1k Ω to 100k Ω in a variety of ratios.



```

NPN Digital BJT
Red-C Green-B
Blue-E
hFE=62
  at IC=5.00mA
Vi(on)=1.482V
  at IC=5.00mA
Vi(off)=1.116V
  at IC=0.10mA
VCEsat=0.060V
  at IC=5.0mA
  with VBE=5.0V
ICLeak=0.000mA
Rinput=10200R
Rshunt=10100R
  
```

Enhancement Mode MOSFETs



MOSFET stands for *Metal Oxide Semiconductor Field Effect Transistor*. They are available in two main types, N-Channel and P-Channel. Most modern MOSFETs are of the Enhancement Mode type, meaning that the bias of the gate-source voltage is always positive (For N-Channel types). The other (rarer) type of MOSFET is the Depletion Mode type which is described in a later section.

MOSFETs of all types have an insulated gate which results in negligible gate current for both positive and negative gate-source voltages (up to the maximum allowed values of course, typically $\pm 8\text{V}$ to $\pm 20\text{V}$).

The first screen to be displayed gives information on the type of MOSFET detected and the pinout.

Pressing **scroll-off** will then result in the gate threshold and other parameters of the MOSFET to be displayed.

The (on) gate threshold voltage is the gate-source voltage at which conduction between the source and drain starts. The *DCA Pro* determines that drain-source conduction has started when it reaches a current of 5.00mA, this is confirmed on the display.

N-Ch Enhancement mode MOSFET
 Red-G Green-S Blue-D 

VGS(on)=2.396V
 at ID=5.00mA
 and IG=0uA

VGS(off)=1.769V
 at ID=5.0uA

gm=30.3mA/V
 at ID=3.0mA to 5.0mA

RDS(on)=1.4R
 at ID=5.0mA
 and VGS=8.0V
 with body diode

An enhancement MOSFET will typically be “off” when the gate-source voltage is 0V.

The *DCA Pro* can drive the gate from 0V to 8V for enhancement mode MOSFETs.

Depletion Mode MOSFETs



The fairly rare Depletion Mode MOSFET is very similar to the conventional Junction FET (JFET) except that the gate terminal is insulated from the other two terminals. The input resistance of these devices can typically be greater than 1000M Ω for negative and positive gate-source voltages.

N-Ch Depletion
mode MOSFET
Red-S Green-D Blue-G

$V_{GS(on)} = -0.927V$
at $I_D = 5.00mA$
and $I_G = 0\mu A$

$V_{GS(off)} = -1.572V$
at $I_D = 5.0\mu A$

$g_m = 25.5mA/V$
at $I_D = 3.0mA$ to $5.0mA$

$R_{DS(on)} = 4.2\Omega$
at $I_D = 5.0mA$
and $V_{GS} = 8.0V$
with body diode



Depletion Mode devices are characterised by the gate-source voltage required to control the drain-source current.

Modern Depletion Mode devices are generally only available in N-Channel varieties and will conduct some current between its drain and source terminals even with a zero voltage applied across the gate and the source. The device can only be turned completely off by taking its gate significantly more negative than its source terminal, say $-5V$. It is this characteristic that makes them so similar to conventional JFETs.

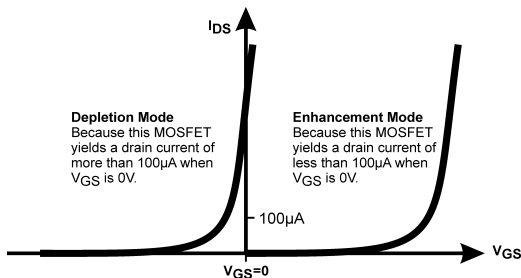

Enhancement Mode IGBTs

IGBT is an acronym for Insulated Gate Bipolar Transistor.

It combines the input characteristics of a MOSFET with the output characteristics of a Bipolar Junction Transistor.

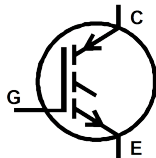

IGBTs are available in N or P channel types, enhancement mode or depletion mode and with or without a free-wheeling diode.

Generally, their operation is very similar to MOSFETs. The saturation capability of an IGBT is often better than an equivalent sized MOSFET at high currents. At low currents, the saturation voltage of an IGBT is often worse than an equivalent sized MOSFET.

N-Ch Enhancement mode IGBT
 Red-E Green-C Blue-G

$V_{GE(on)} = 5.358V$
 at $I_C = 5.00mA$
 and $I_G = 0\mu A$

$V_{GE(off)} = 4.315V$
 at $I_C = 5.0\mu A$

$g_{fe} = 23.4mA/V$
 at $I_C = 3.0mA$ to $5.0mA$

$V_{CE(sat)} = 0.604V$
 at $I_C = 5.0mA$
 and $V_{GE} = 8.0V$
 with body diode



In this example we have an N-Channel IGBT with an integral free wheeling diode.

Note the names of the leads; Gate, Collector and Emitter.

Similar to the MOSFET analysis, the gate threshold is the voltage between the gate and emitter that causes the device to start conducting (between the collector and emitter). The *DCA Pro* determines that conduction has started if the collector current has reached 5mA.

The *DCA Pro* can drive the gate from 0V to 8V for enhancement mode IGBTs.

(IGBT symbol based on EN60617: 05-05-19)

Depletion Mode IGBTs

Like MOSFETs, IGBTs are available as enhancement mode and depletion mode types.

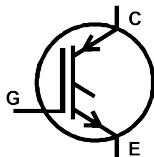

Depletion mode IGBTs are characterised by the fact that current can flow between the collector and emitter when there is zero voltage across the gate-emitter terminals.

For an N-Channel depletion mode IGBT, the device can only be turned off fully if the gate terminal is taken more negative with respect to the emitter lead.

```

N-Ch Depletion
mode IGBT
Red-E Green-G Blue-C
VGE(on)=-0.155V
  at IC=5.00mA
  and IG=0uA
VGE(off)=-1.952V
  at IC=5.0uA
gfe=19.3mA/V
  at IC=3.0mA to 5.0mA
VCEsat=0.580V
  at IC=5.0mA
  and VGE=8.0V
  
```



In this example we have an N-Channel depletion mode IGBT with no free wheeling diode.

Note the negative gate threshold voltage, characteristic of a depletion mode device.

The *DCA Pro* can drive the gate from 0V to -5V for depletion mode IGBTs.

Junction FETs (JFETs)

Junction FETs are conventional Field Effect Transistors. Here we refer to them as JFETs.

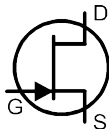

The voltage applied across the gate-source terminals controls current between the drain and source terminals. N-Channel JFETs require a negative voltage on their gate with respect to their source, the more negative the voltage, the less current can flow between the drain and source.

Unlike Depletion Mode MOSFETs, JFETs have no insulation layer on the gate. This means that although the input resistance between the gate and source is normally very high (greater than $100\text{M}\Omega$), the gate current can rise if the semiconductor junction between the gate and source or between the gate and drain become forward biased. This can happen if the gate voltage becomes about 0.6V higher than either the drain or source terminals for N-Channel devices or 0.6V lower than the drain or source for P-Channel devices.

The internal structure of JFETs is essentially symmetrical about the gate terminal, this means that the drain and source terminals of the JFET are often indistinguishable by the *DCA Pro*. The JFET type, gate terminal and measured parameters are displayed however.

N-Ch JFET
Blue-G
Symmetrical Src/Drn



Pinch-Off

A common parameter to be specified for JFETs is “Pinch-Off”. This is the voltage needed between the gate-source to turn off the JFET. The *DCA Pro* will determine that the JFET is off when the drain current is less than $5\mu\text{A}$.

$V_{GS(\text{off})} = -6.65\text{V}$
at $I_D = 5.0\mu\text{A}$



“On” Characteristics

The *DCA Pro* measures the gate-source voltage required to reach the onset of good conduction through the JFET’s drain-source. Good conduction is determined when the drain-source current reaches 5mA. For JFETs that have a lower saturation current (I_{DSS}) than 5mA, the *DCA Pro* will select a lower “on” current.

$V_{GS(on)} = -1.10V$
at $I_D = 5.00mA$



Transconductance

While the JFET is conducting, the JFET’s gain (transconductance) is measured. Transconductance is often measured in mA/V, mmhos or mSiemens. This refers to the change in drain current resulting from a change in gate-source voltage:

$g_{fs} = 13.6mA/V$
at $I_D = 3.0mA$ to $5.0mA$



$$g_{fs} = \Delta I_{DS} / \Delta V_{GS}$$

The *DCA Pro* measures transconductance by determining the gate voltage change necessary to obtain a drain current change from 3.0mA to 5.0mA. If the JFET’s saturation current (I_{DSS}) is less than 5.0mA then a proportionately lower current span will be used.

I_{DSS} Drain Current (for $V_{GS}=0$)

Finally, the drain current for a zero gate-source voltage is measured. This is measured for a drain-source voltage of nominally 3.0V but may be lower if the drain current exceeds 12mA.

$I_{DSS} = 6.67mA$
at $V_{DS} = 3.00V$



Transconductance is measured by the *DCA Pro* over a small range of drain current (typically a span of 3-5mA). Values of transconductance higher than 20mA/V can yield a coarse measurement resolution as the required change in gate voltage is so tiny. Values above 99mA/V are displayed as “>99mA/V”.

Thyristors (SCRs) and Triacs

Sensitive low power thyristors (Silicon Controlled Rectifiers - SCRs) and triacs that require gate currents and holding currents of less than 10mA can be identified and analysed with the *DCA Pro*.

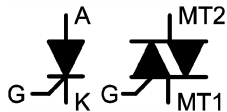

Thyristor terminals are the anode (A), cathode (K) and the gate (G).

This example shows that a thyristor has been detected:

Thyristor (SCR)
Red-G Green-K Blue-A

Triac terminals are MT1, MT2 and gate (the letters MT stand for main terminal). MT1 is the terminal with which gate current is referenced.

Triac
Red-MT1 Green-G
Blue-MT2

The unit determines that the device under test is a triac by checking the gate trigger quadrants that the device will reliably operate in. Thyristors operate in only one quadrant (positive gate current, positive anode current). Triacs can typically operate in three or four quadrants, hence their use in AC control applications.

The gate trigger currents used by the *DCA Pro* are limited to less than 10mA. Some thyristors and triacs will not operate at low currents and these types cannot be analysed with this instrument. Note also that if only one trigger quadrant of a triac is detected then the unit will conclude that it has found a thyristor. Please see the technical specifications for more details. The *Atlas SCR* (model SCR100) instrument is designed for analysing triacs and thyristors that require currents up to 90mA to operate.

Voltage Regulators

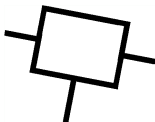

The *DCA Pro* is able to identify many types of regulator, typically regulators with outputs less than 8V, depending on current requirements.

When a regulator is identified, its pinout, output voltage, quiescent current consumption and drop-out voltage are displayed.

```
Voltage Regulator
Red-IN Green-OUT
Blue-GND
VOUT=5.026V
IQ=2.21mA
VDO=1.59V
dVOUT=0.003V
```



The stability of the output voltage measurement is also displayed (dV_{OUT}) to help you assess if the *DCA Pro* has experienced a stable test or not, it is not a measure of the regulator's output ripple or noise.

Negative voltage regulators (such as the popular 79L05) will be shown with a negative V_{OUT} figure.



Some voltage regulators are not stable when used outside of their intended circuitry (decoupling capacitors, proper loads etc). The *DCA Pro* may not be able to identify the regulator correctly if it is not stable during analysis.



The displayed drop-out voltage (V_{DO}) is the voltage that is required between input and output of the regulator to enable voltage regulation to take place. Common regulators have a drop-out voltage of around 2V. Many “Low drop-out” regulators may have a drop-out voltage of 0.5V or less. The *DCA Pro* measures drop-out at very low load currents on the regulator's output (typically less than 1mA). The drop-out voltage of a regulator increases significantly with load current.

PC Software Installation

The *DCA Pro* can be used in conjunction with a PC running Windows XP or later.*

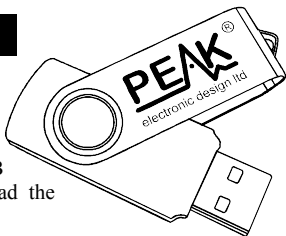

Software is provided on the included USB flash drive. Alternatively, you can download the latest PC software package from:

www.peakelec.co.uk/downloads/dcaprosetup.exe

Before you install the software, ensure you have sufficient (administrator) rights on your machine. Additionally, ensure your PC meets the following requirements:

- Windows XP(SP3), Vista, 7, 8, 10 or later.*
- 1GB RAM.
- 1GB Hard Disk free.
- Display size 1024 x 600 minimum (typical netbook resolution).
- 16 bit colour or better.
- USB 1.1 or better.
- .NET framework 4 (automatically installed if required).
- Internet connection required for online updates.

* Verified on UK localisation of Windows 10 at time of this user guide going to print.

The installation process varies depending on your version of Windows. Select the appropriate section over the next few pages and follow the step-by-step instructions carefully.



Please don't connect your *DCA Pro* just yet

Windows XP Installation

1. Make sure you have the latest Windows Updates and Service Pack 3.
2. Run “Setup.exe” on the supplied USB flash drive. Alternatively, you can download and run the installation file from our web site:
www.peakelec.co.uk/downloads/dcaprosetup.exe
3. During the setup process, you may be asked to install .NET Framework 4. The installation files for that are included on the USB flash drive and don’t need to be downloaded. If you are running the installation from a downloaded copy of our software then you may be prompted to download the .NET package. You need to accept the Microsoft agreement and the process will complete in a few minutes (sometimes up to 10 minutes).

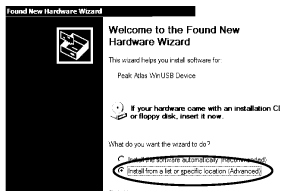

4. When the *DCA Pro* software installation is complete, you can plug in your *DCA Pro* to a convenient USB socket. It’s best to choose a socket directly on your computer rather than a hub. After a few seconds, you should be presented with the “Found New Hardware Wizard”. Make sure you select **“Install from a list or specific location”** and then click Next.

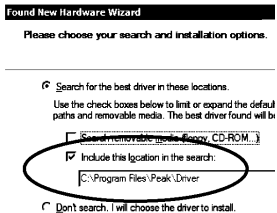

5. You will then be presented with this window. Make sure the box **“Include this location in the search”** is checked. It should already be filled with the location for the Peak Driver. Then click Next.
6. Your *DCA Pro* should chime when your software is ready to use.

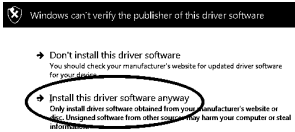

Windows Vista, 7, 8 and 10 Installation

1. Make sure you have the latest Windows Updates and Service Pack.
2. Run “Setup.exe” on the supplied USB flash drive. Alternatively, you can download and run installation file from our web site:
www.peakelec.co.uk/downloads/dcaprosetup.exe
3. During the setup process, you may be asked to install .NET Framework 4. The installation files for that are included on the USB flash drive and don't need to be downloaded. If you are running the installation from a downloaded copy of our software then you may be prompted to download the .NET package. You need to accept the Microsoft agreement and the process will complete in a few minutes (sometimes up to 10 minutes).
4. Some systems may warn you that the driver is not signed. The driver is in fact a standard Microsoft WinUSB driver that is set to look for the *DCA Pro* identifier, so it is fine to accept the warning and proceed.
5. When the *DCA Pro* software installation is complete, you can plug in your *DCA Pro* to a convenient USB socket. It's best to choose a socket directly on your computer rather than a hub. Windows should install the drivers automatically although it can take a minute or two. You should see the driver installation activity in the bottom right of your screen.
6. If prompted, let Windows download the latest WinUSB drivers. Don't worry if it takes a few minutes.
7. Your *DCA Pro* should chime when your software is ready to use.

Running the DCA Pro PC software for the first time

Now you're ready to start the *DCA Pro* companion software. You can start the software in the following ways:

All Windows Versions

Double click on the desktop icon.

or

Click on the “DCA Pro” item in the “Peak” folder of your start menu.

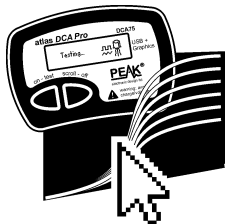

Windows Vista, 7, 8 & 10 (Desktop mode)

Type “DCA Pro” into your start menu search box.

It doesn't matter if you connect your *DCA Pro* *before* or *after* starting the software.

When your DCA Pro is connected and your software is running, you should see the green message **DCA Pro connected** in the bottom left corner of the program window.

For the first time you use the software, if you see the message: **DCA Pro disconnected** then try unplugging the USB cable, wait a few seconds and plug back in. If that doesn't work (depending on your version of Windows) then you may need to restart your PC to allow the WinUSB drivers to initialise.

If you're still having problems then you may wish to try uninstalling the software and drivers and then re-trying the installation process by following the step-by-step instructions shown earlier.

Please contact us if you have any difficulties, we're here to help.

Analysing Semiconductors – PC mode

When the *DCA Pro* is connected to the PC and the PC is running the companion software, the instrument can be used from the PC screen or from the instrument itself.

Pressing “**Test**” in the PC software will initiate a component analysis in just the same way as pressing “**Test**” on the instrument itself.

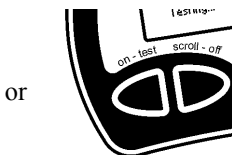
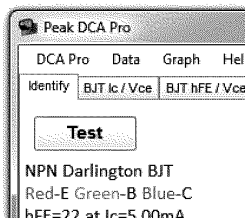

Any test results are automatically passed to the PC software and displayed in a text window. Additionally, the component schematic and the colour-coded pinout are also displayed:

NPN Darlington BJT
 Red-E Green-B Blue-C
 hFE=22 at Ic=5.00mA
 Vbe=1.159V at Ib=5.01mA
 VceSat=0.544V at Ic=5.0mA and Ib=1.00mA
 IcLeak=0.000mA
 Rshunt=4140R
 with protection diode

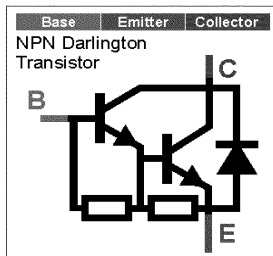

Note that the component schematic is displayed in colour to illustrate which colour test lead is connected to each component lead.

Curve Tracing

After a component has been analysed, you can perform further tests on the component, such as curve tracing various component parameters.

Curve tracing is best performed after the *DCA Pro* has correctly identified the component and correctly identified the pinout.

Depending on the component type, various curve options will become available from the “Graph” menu.

Selecting the desired curve type will take you to a fresh curve tab.

In many cases, you can simply start a new curve with the automatically selected parameters by clicking the curve “start” button.

A rectangular button with a dotted border and the word "Start" in bold black text.

You may adjust the parameters, but any parameters that are out of range may lead to unexpected results. Refer to *Appendix C* in this user guide that shows the analysis test circuits to see how test parameters are applied.

You may not be able to perform curve tracing in the following circumstances:

- Transistor gain is very low and the *DCA Pro* is unable to generate sufficient base current to obtain a sufficient span of collector current.
- Transistor (Darlington) gain is extremely high which means that the tiny base currents cannot be generated with fine enough resolution.
- If the component requires more than 12mA (into a short circuit) to analyse.
- If the component requires more than 12V (into an open circuit) to analyse.
- If the component requires a combination of voltage and current that cannot be generated (due to 700 Ohm current limiting resistance).



If you want to test other components using the same test parameters (to easily compare parts), connect your component in exactly the same configuration and press “Start” on the graph tab. **Don’t** press “Test” as that will cause the test parameters to be re-evaluated for the new component and you won’t be able to plot with the same values as your previous test.

Curve Tracing – Export Raw Data

After the curve tracing operation has completed, you can copy the raw measurement data into the clipboard ready to be pasted into your spreadsheet program.

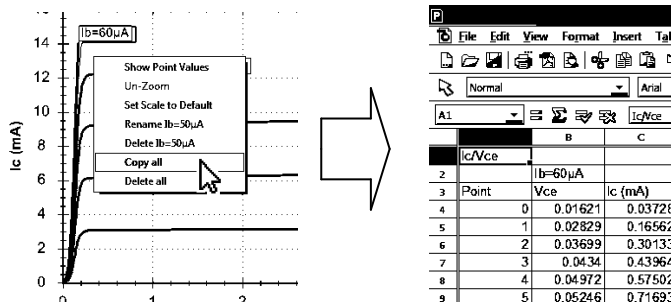

Pasting the data into a spreadsheet is an ideal way of documenting important test results.

Simply right-click on one of the curves and select “Copy all”. All the raw measurement data that created the curves is now in the clipboard. You can then paste the data into your spreadsheet.

This feature has been tested with *Microsoft Excel*™, *SoftMaker PlanMaker*© and *Apache Open Office*™. Other spreadsheet programs should work fine too.

Once the raw data is pasted into your spreadsheet, you can perform your own tasks such as charting and mathematical analysis.

Special Functions

Firmware Upgrade

From the program's "Help" menu, select "Check for Updates".

If you are connected to the internet, the program will check for new PC Software (that includes the latest firmware). If newer software is available, you will be guided to the download location.

The programming operation should take no more than a minute or so. Don't interrupt the process and wait for the confirmation that the programming operation has been successfully completed.



Don't worry if the firmware upgrade process doesn't succeed first time. Windows sometimes takes time to prepare the built-in HID driver that is used during the firmware upgrade process. If the firmware upgrade process fails, don't panic, just try again, it should be fine once Windows gets its built-in driver initialised. Peak guarantee to help you if you have any problems with upgrading using our official firmware.

LCD Contrast

The PC software allows you to adjust the instrument's LCD contrast.

From the program's "DCA Pro" menu, select "LCD Contrast".

You will then be presented with a simple slider to make your contrast adjustments. When you're finished, you can click on the cross of the slider window. Your new contrast value is automatically saved within the *DCA Pro*.

Audible Settings



Your *DCA Pro* has a built-in sounder for alerting you to various test results and conditions. Additionally, the sounder produces short tones to reinforce the tactile feedback when pressing buttons.

Here is a summary of the various tone types:

Condition	Tone Type
Power-up.	Rising 3 notes.
Power-down, including auto-off.	Falling 3 notes.
Button press.	Very short “blip”.
Component detected.	Short Low-High.
Faulty, unknown or no part detected.	Long High-Low.

If you wish, you can switch the audible alerts on or off.

To change the current setting for audible alerts, while the unit is already on, simply press and hold the **on-test** button for a few seconds.

The new sound setting will then be confirmed on the screen.

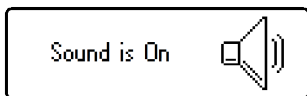
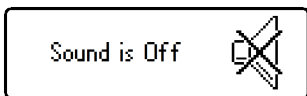

To change back again, simply press and hold the **on-test** button again for a few seconds.

Care of your *Peak Atlas DCA Pro*



Your *DCA Pro* should provide many years of service if used in accordance with this user guide. Care should be taken not to expose your unit to excessive heat, shock, moisture or electrical abuse.

Battery Replacement

The battery should be replaced at least every 12 months to reduce the risk of leak damage.

Please replace
the battery.



If a low battery warning message appears, immediate replacement of the battery is required.

To replace the battery: place the *DCA Pro* face-down on a smooth surface, remove the 3 screws, remove the rear cover and change the battery while the unit is still resting face down.

We recommend using a high quality Alkaline, NiMh or Lithium-Iron-Disulphide AAA cell (such as LR03 or MN2400 1.5V).

Replace the cover (take care not to pinch the test cables) and carefully tighten the 3 screws. **DO NOT OVER-TIGHTEN THE SCREWS.**

Overload Protection

! The *DCA Pro* is protected against mild overload conditions but remember that it can be damaged by applying the probes to a charged component or a component that is in-circuit. !

Please note that it is also possible to damage the *DCA Pro* if the device under test has a route to earth and you also have your USB cable connected to a PC (many PCs have large offset voltages on their ports relative to earth).

Appendix A – Troubleshooting

First thing to do:

It is important that you ensure you've got the latest version of firmware (software that's inside the *DCA Pro* instrument) and the latest version of PC software. You can do this by connecting the unit to your PC and selecting the "Help" menu and then click on "Check for Updates".

Problem	Possible Solutions
PC software always says "Disconnected" in the status bar even when the <i>DCA Pro</i> is connected and powered up.	Unplug USB, wait a few seconds and plug back in. Try a different USB socket on your PC. Restart your PC. Uninstall and then Re-install the software.
Unit displays "Boost timeout" on the LCD	It is possible that your battery is in poor condition. Replace with a new Alkaline AAA battery.
Measured parameters don't agree with the component data sheet.	Most semiconductors have very wide tolerances and even identical transistor types can show huge gain variation between them. Characteristics shown in data sheets may be specified at different test conditions compared to the test conditions used by the <i>DCA Pro</i> .
My voltage regulator is not being identified.	Not all voltage regulators are stable when tested outside their intended circuit with decoupling capacitors and a load. The <i>DCA Pro</i> cannot provide the ideal conditions for all regulators. If the regulator requires a voltage greater than about 9V to start regulating then it may have difficulty testing your regulator.
Results are always wrong or the unit fails to start correctly.	If the displayed results are always wrong then it is likely that the unit has been damaged due to a charge/voltage on the probes. Contact us for help.

Feel free to contact us for technical assistance. Our contact details are shown at the end of this user guide.

Appendix B – General Technical Specifications

Parameter	Min	Nom	Max	Units	Notes
Voltage Measurement (-12V to +12V)					
Resolution	3.7	7.4	14.7	mV	1
Accuracy			±1.2% ±15mV		1
Voltage Drive (-12V to +12V)					
Resolution	4.6	9.2	18.3	mV	1
Accuracy			±1.2% ±19mV		1
Current Measurement (0 to 20µA)					
Resolution	0.01	0.02	0.04	µA	1
Accuracy			±1.7% ±0.14µA		1
Current Drive (0 to 20µA)					
Resolution	0.01	0.02	0.04	µA	1
Accuracy			±1.7% ±0.14µA		1
Current Measurement (0 to 140µA)					
Resolution	0.06	0.11	0.22	µA	1
Accuracy			±1.7% ±0.32µA		1
Current Drive (0 to 140µA)					
Resolution	0.07	0.14	0.27	µA	1
Accuracy			±1.7% ±0.37µA		1
Current Measurement (0 to 1.2mA)					
Resolution	0.45	0.90	1.79	µA	1
Accuracy			±1.7% ±1.9µA		1
Current Drive (0 to 1.2mA)					
Resolution	0.56	1.12	2.23	µA	1
Accuracy			±1.7% ±2.4µA		1
Current Measurement (0 to 10mA)					
Resolution	3.7	7.4	14.7	µA	1
Accuracy			±1.7% ±15µA		1
Current Drive (0 to 10mA)					
Resolution	4.6	9.2	18.3	µA	1
Accuracy			±1.7% ±19µA		1
Load Current Measurement (0 to 12mA)					
Resolution	6.6	13.1	26.2	µA	1,2
Accuracy			±1.7% ±27µA		1,2
Load Current Drive (0 to 12mA)					
Resolution	8.2	16.4	32.7	µA	1,2
Accuracy			±1.7% ±33µA		1,2
General					
Short circuit detection threshold	3.7	7.3	11.0	Ω	1
Peak current into short circuit	-15.5		15.5	mA	1
Peak voltage across open circuit	-13.5		13.5	V	1
Battery type	1 x AAA Alkaline / NiMh / Lithium-Iron-Disulphide				
Battery voltage	1.0	1.5	1.9	V	
USB current consumption	500mA peak active, <2mA sleep.				
Dimensions (body)	103 x 70 x 20 mm				

CS253.460

Notes for this table:

1. Between any 2 leads.
2. Used for transistor load current or PN V/I drive.

Appendix C – Component Testing Specifications

Parameter	Min	Nom	Max	Units	Notes
Bipolar Transistors					
Measurable current gain (hFE) range	2		32000		1
hFE accuracy (hFE<2000)			±3% ±5 hFE		1,7
hFE test voltage (VCEO)	3.0		9.0	V	1
hFE collector test current	4.75	5.00	5.25	mA	1
Base current for VBE measurement	4.75	5.00	5.25	mA	
VBE accuracy			±1.2% ±15mV		7
VBE resolution	3	7	15	mV	
VBE for Darlington identification	0.95	1.00	1.80	V	2
VBE for Darlington (shunted types)	0.75	0.80	1.80	V	3
VBE threshold for Ge/Si identification		0.50		V	
If I _{CEO} >10µA		0.55		V	9
Acceptable VBE			1.80		
Base-emitter shunt threshold	50	60	70	kΩ	
Acceptable leakage (I _{CEO}) for Si	0.0		0.2	mA	5
Acceptable leakage (I _{CEO}) for Ge	0.0		2.4	mA	5
Leakage (I _{CEO}) accuracy			±1.7% ±13.1µA		
VCE(SAT) collector test current	4.75	5.00	5.25	mA	
VCE(SAT) base test current	0.95	1.00	1.05	mA	
VCE(SAT) accuracy			±1.2% ±15mV		
IGBTs					
Enhancement mode VGE(ON) range	0.0		8.0	V	4
Depletion mode VGE(ON) range	-5.0		0.0	V	4
VGE(ON) accuracy			±1.2% ±19mV		4
Collector current at VGE(ON)	4.75	5.00	5.25	mA	
Collector-emitter voltage at VGE(ON)	3.5		9.0	V	4
Acceptable gate-emitter resistance	18.0			kΩ	
Collector saturation threshold for IGBT	0.35	0.4	0.45	V	8
VCE(SAT) collector test current	4.75	5.00	5.25	mA	
VCE(SAT) gate-emitter test voltage	7.80	8.00	8.20	V	10
VCE(SAT) accuracy			±1.2% ±15mV		
Transconductance range (g _{fe})			99	mA/V	
Transconductance accuracy		±5% ±2mA/V	±10% ±5mA/V		
MOSFETs					
Enhancement mode VGS(ON) range	0.0		8.0	V	4
Depletion mode VGS(ON) range	-5.0		0.0	V	4
VGS(ON) accuracy			±1.2% ±19mV		4
Drain current at VGS(ON)	4.75	5.00	5.25	mA	
Drain-source voltage at VGS(ON)	3.5		9.0	V	
Drain current at VGS(OFF)	2.5	5.00	10	µA	
Acceptable gate-source resistance	3.5			kΩ	
RDS(ON) drain test current	4.75	5.00	5.25	mA	
RDS(ON) gate-source test voltage	7.80	8.00	8.20	V	10
RDS(ON) accuracy			±2% ±2Ω		
RDS(ON) resolution		1	2	Ω	
Transconductance range (gm)			99	mA/V	
Transconductance accuracy		±5% ±2mA/V	±10% ±5mA/V		

CS32659.750

Specifications continued...

Parameter	Min	Nom	Max	Units	Notes
JFETs					
Pinch-off VGS(OFF) range	-10		2.5		
Drain current at Pinch-off	2.5	5.0	10.0	μA	
Drain current at VGS(ON)	4.75	5.00	5.25	mA	
Drain-source voltage at VGS(ON)	3.5		9.0	V	
VDS for IDSS measurement		3.0	3.25	V	
IDSS measurement range	1.0		12.0	mA	
VDS for IDSS measurement	0.0	3.0	3.5	V	
IDSS accuracy			$\pm 1.7\% \pm 13.1 \mu\text{A}$		
RDS(ON) drain test current	4.75	5.00	5.25	mA	11
RDS(ON) gate-source test voltage	7.80	8.00	8.20	V	12
RDS(ON) accuracy			$\pm 2\% \pm 2\Omega$		
RDS(ON) resolution		1.0	2.0	Ω	
Transconductance range (gfs)			99	mA/V	
Transconductance accuracy		$\pm 5\% \pm 2 \text{mA/V}$	$\pm 10\% \pm 5 \text{mA/V}$		
Thyristors (SCRs) and Triacs					
Gate test current	8.0	10.0	12.0	mA	6
Load test current		10.0	15.0	mA	
Diodes and LEDs					
Forward test current	4.75	5.00	5.25	mA	
Forward voltage accuracy			$\pm 1.2\% \pm 19 \text{mV}$		
Acceptable VF for a diode at 5mA	0.15			V	
VF for a LED decision at 5mA	1.50		4.00	V	
Zener Diodes					
Zener voltage range at 5mA	1.8	7.0		V	
Zener voltage range below 5mA		6.0	11.0	V	
Zener voltage accuracy			$\pm 1.2\% \pm 19 \text{mV}$		
Zener test current range	0.50	5.00	5.25	mA	
Voltage Regulators					
Input test voltage range ($I_Q < 2.0 \text{mA}$)	1.1		10.0	V	
Input test voltage range ($I_Q < 4.0 \text{mA}$)			8.0	V	
Acceptable quiescent current range (I_Q)	0.0	6.0		mA	
Quiescent current accuracy			$\pm 1.7\% \pm 13.1 \mu\text{A}$		
Dropout voltage range	0.00		3.00	V	
Output voltage accuracy			$\pm 1.2\% \pm 19 \text{mV}$		

CS344.550

Notes:

- Collector current of 5mA. Gain accuracy for gains less than 2000.
- Resistance across reverse biased base-emitter $> 60 \text{k}\Omega$.
- Resistance across reverse biased base-emitter $< 60 \text{k}\Omega$.
- Load current of 5mA.
- Collector-emitter voltage of 5.0V.
- Thyristor quadrant I, Triac quadrants I and III.
- BJT with no shunt resistors.
- Load current typically 10mA.
- Transistor has leakage of more than $10 \mu\text{A}$.
- IGBT/MOSFET gate test voltage is reduced to 5V if gate leakage is detected.
- Lower drain test current is used if $I_{DSS} < 7 \text{mA}$.
- For normally-off JFETs, a gate voltage that results in $10 \mu\text{A}$ of gate current will be used.

Appendix D – Analysis Test Circuits

The *DCA Pro* analyses components by applying signals to the component under test while in a “test circuit”. The test circuits that the *DCA Pro* uses to analyse various components are shown below.

These test circuits are presented here to assist in your understanding of the test conditions that are possible when testing in standalone mode and in the PC mode (for curve tracing etc).

Transistor Test Circuit

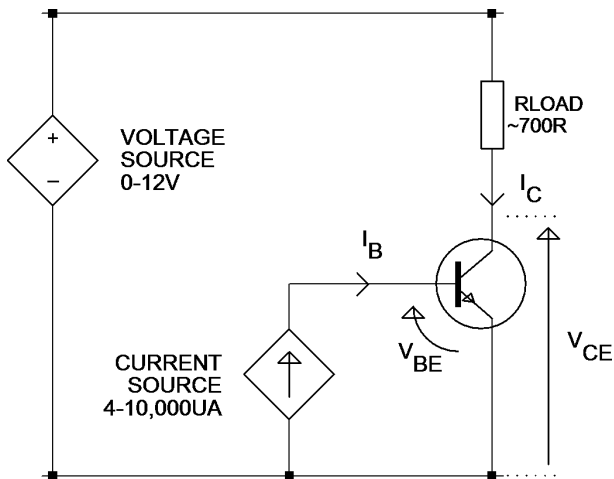

Example shown is for an NPN transistor. Polarities are reversed for PNP devices.

JFET/MOSFET/IGBT Test Circuit

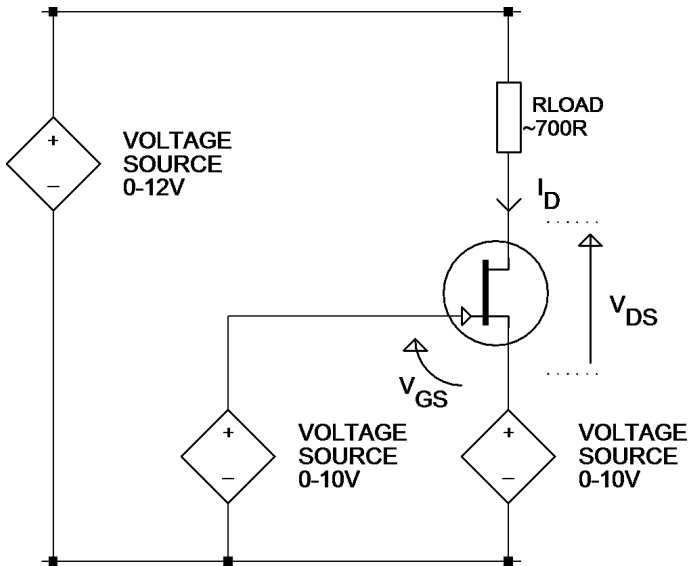

It's important to note that the gate-source voltage can be driven negative by making the source voltage drive higher than the gate voltage drive. When this is done however, there is less voltage available to be across the drain-source nodes and the load resistor.

Example shown is for an N-Channel JFET. Polarities are reversed for P-Channel devices.

Diode Test Circuit

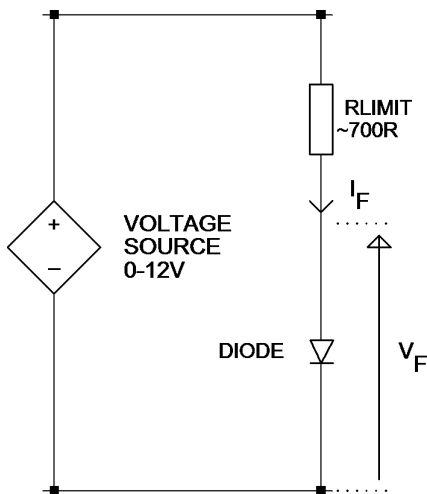

This test circuit is used for testing both the forward and reverse characteristics of diodes. Reverse characteristics are particularly useful for the testing of Zener diodes.

For the standalone mode, the voltage is automatically adjusted to obtain a “target” current of 5mA. For Zener diodes that have a breakdown voltage of more than about 7V then a lower test current will be used.

Voltage Regulator Test Circuit

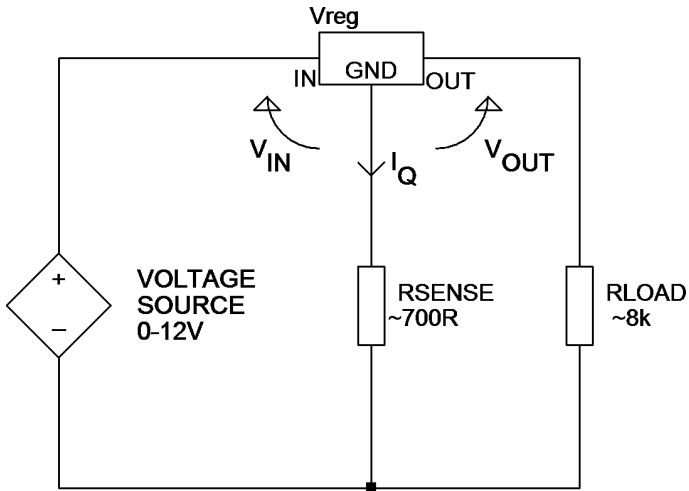

The test circuit shown here is used for the analysis of voltage regulators (positive regulators in this example). Note that the range of regulator voltages supported will depend on the quiescent current (I_Q). A higher quiescent current will cause more voltage to be dropped across the sense resistor and yield less voltage for the regulator itself.

Note also that some voltage regulators, particularly low dropout types (LDO), are not stable when tested by the **DCA Pro**.

Appendix E – Warranty Information

Peak Satisfaction Guarantee - If for any reason you are not completely satisfied with your *DCA Pro* within 14 days of purchase you may return the unit to your distributor. You will receive a refund covering the full purchase price if the unit is returned in perfect condition.

Peak Warranty - The warranty is valid for 24 months from date of purchase. This warranty covers the cost of repair or replacement due to defects in materials and/or manufacturing faults. The warranty does not cover malfunction or defects caused by:

- Operation outside the scope of the user guide.
- Unauthorised access of the unit (except for battery replacement).
- Accidental physical damage or abuse.
- Normal wear and tear.

Statutory rights unaffected. Claims must be accompanied by proof of purchase.

Appendix F – Disposal Information

WEEE (Waste of Electrical and Electronic Equipment), Recycling of Electrical and Electronic Products

In 2006 the European Union introduced regulations (WEEE) for the collection and recycling of all waste electrical and electronic equipment. It is no longer permissible to simply throw away electrical and electronic equipment. Instead, these products must enter the recycling process. Each individual EU member state has implemented the WEEE regulations into national law in slightly different ways. Please follow your national law when you want to dispose of any electrical or electronic products. **More details can be obtained from your national WEEE recycling agency.** If in doubt, you may send your Peak Product to us for safe and environmentally responsible disposal.

At Peak Electronic Design Ltd we are committed to continual product development and improvement.
The specifications of our products are therefore subject to change without notice.

Designed and manufactured in the UK © 2012/2019 Peak Electronic Design Limited - E&OE
www.peakelec.co.uk Tel. +44 (0) 1298 70012

Notes