

## Data sheet | Item number: 880-837

4-conductor ground terminal block; 4 mm<sup>2</sup>; side and center marking; for DIN-rail 35 x 15 and 35 x 7.5; CAGE CLAMP®; 4,00 mm<sup>2</sup>; green-yellow

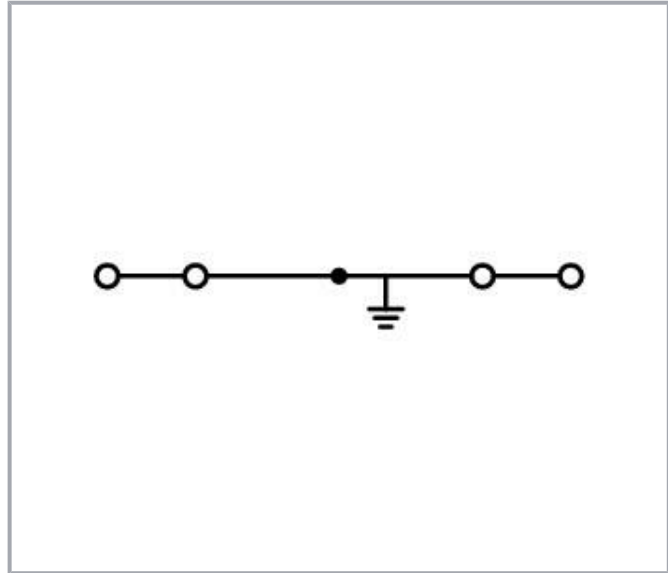

[www.wago.com/880-837](http://www.wago.com/880-837)

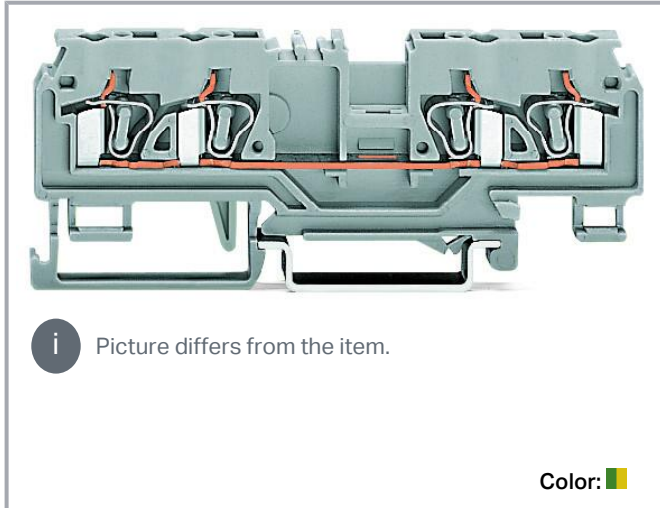

### Data

#### Electrical data

#### Ratings per IEC/EN

Ratings per IEC/EN 60947-7-2

#### Connection data

|                            |   |
|----------------------------|---|
| Connection points          | 4 |
| Total number of potentials | 1 |
| Number of levels           | 1 |

#### Connection 1

|                                 |                                            |
|---------------------------------|--------------------------------------------|
| Connection technology           | CAGE CLAMP®                                |
| Actuation type                  | Operating tool                             |
| Connectable conductor materials | Copper                                     |
| Solid conductor                 | 0.08 ... 4 mm <sup>2</sup> / 28 ... 12 AWG |
| Fine-stranded conductor         | 0.08 ... 4 mm <sup>2</sup> / 28 ... 12 AWG |

Subject to changes. Please also observe the further product documentation!

WAGO GmbH & Co. KG  
Hansastr. 27  
32423 Minden  
Phone: +49571 887-0 | Fax: +49571 887-169  
Email: [info.de@wago.com](mailto:info.de@wago.com) | Web: [www.wago.com](http://www.wago.com)

Do you have any questions about our products?  
We are always happy to take your call at +49 (571) 887-44222.



|                  |                                   |
|------------------|-----------------------------------|
| Strip length     | 8 ... 9 mm / 0.31 ... 0.35 inches |
| Wiring direction | Front-entry wiring                |

### Physical data

|                                   |                      |
|-----------------------------------|----------------------|
| Width                             | 5 mm / 0.197 inches  |
| Height                            | 87 mm / 3.425 inches |
| Depth from upper-edge of DIN-rail | 29 mm / 1.142 inches |

### Mechanical Data

|               |                     |
|---------------|---------------------|
| Design        | horizontal type     |
| Mounting type | DIN-35 rail         |
| Marking level | Center/side marking |

### Material Data

|                             |                                                          |
|-----------------------------|----------------------------------------------------------|
| Note (material data)        | Information on material specifications can be found here |
| Color                       | green-yellow                                             |
| Material group              | I                                                        |
| Insulation material         | Polyamide (PA66)                                         |
| Flammability class per UL94 | V0                                                       |
| Fire load                   | 0.157 MJ                                                 |
| Weight                      | 14.3 g                                                   |

### Environmental requirements

|                                  |                 |
|----------------------------------|-----------------|
| Processing temperature           | -35 ... +85 °C  |
| Continuous operating temperature | -60 ... +105 °C |

### Commercial data

|                   |             |
|-------------------|-------------|
| eCl@ss 10.0       | 27-14-11-41 |
| eCl@ss 9.0        | 27-14-11-41 |
| ETIM 8.0          | EC000901    |
| ETIM 7.0          | EC000901    |
| PU (SPU)          | 50 pcs      |
| Packaging type    | box         |
| Country of origin | DE          |

Subject to changes. Please also observe the further product documentation!



|                       |               |
|-----------------------|---------------|
| GTIN                  | 4045454084790 |
| Customs tariff number | 85369010000   |

**Environmental Product Compliance**

|                                           |                                      |
|-------------------------------------------|--------------------------------------|
| CAS-No.                                   | 7439-92-1                            |
| REACH Candidate List Substance            | Lead                                 |
| RoHS Compliance Status                    | Compliant,With Exemption             |
| RoHS Exemption                            | 6(c)<br>7(a)<br>7(c)-I<br>7(c)-II    |
| SCIP notification number (Austria)        | 22629ebc-e45b-4ac8-bda2-a7ecfb6e462f |
| SCIP notification number (Belgium)        | 443e6671-b348-4b5a-925e-86a6b9b4094e |
| SCIP notification number (Bulgaria)       | 37b18775-9f90-4198-8d87-c8202f1c1b56 |
| SCIP notification number (Czech Republic) | e7d1222c-9558-4b43-b753-ac99abdf11b8 |
| SCIP notification number (Denmark)        | ca16f8a2-b300-4bef-8b24-6996bbd59908 |
| SCIP notification number (Finland)        | eb4aeaa9-8b77-4710-aed7-82e37097e913 |
| SCIP notification number (France)         | b766bc5e-0ea5-410f-a624-107c4f6a50c2 |
| SCIP notification number (Germany)        | 66298f12-9bef-4544-be36-211f28a0135d |
| SCIP notification number (Hungary)        | 8435d41e-2348-416e-9358-96ae6bf4b9aa |
| SCIP notification number (Italy)          | a56f36bc-c2a6-4919-ae51-3c44fb235bcd |
| SCIP notification number (Netherlands)    | e35ed3d4-1e02-4830-9e47-9a9e74c61c85 |
| SCIP notification number (Poland)         | 7ea15c46-9a2a-4850-8356-e6fec3d5c606 |
| SCIP notification number (Romania)        | 8c1d57bc-9157-4469-96bd-9edbb82d77a2 |
| SCIP notification number (Sweden)         | e5a664b7-36dc-4838-ba35-01ce95f18df2 |

**Approvals / Certificates****General approvals**

| Logo                                                                               | Approval                             | Additional Approval Text | Certificate name |
|------------------------------------------------------------------------------------|--------------------------------------|--------------------------|------------------|
|  | UL<br>Underwriters Laboratories Inc. | UL 1059                  | E45172           |

**Required accessories****End plate**

|           |
|-----------|
| End plate |
|-----------|

Subject to changes. Please also observe the further product documentation!

**Item no.: 880-344**

End and intermediate plate; 2.5 mm thick; gray















[www.wago.com/880-344](http://www.wago.com/880-344)**Item no.: 880-346**

End and intermediate plate; 2.5 mm thick; orange

[www.wago.com/880-346](http://www.wago.com/880-346)

## Optional accessories

















### Ferrule

| Ferrule                                                                           |                                                                                                                                                                                        |                                                                |
|-----------------------------------------------------------------------------------|----------------------------------------------------------------------------------------------------------------------------------------------------------------------------------------|----------------------------------------------------------------|
|    | <b>Item no.: 216-106</b><br>Ferrule; Sleeve for 2.5 mm <sup>2</sup> / AWG 14; uninsulated; electro-tin plated; silver-colored                                                          | <a href="http://www.wago.com/216-106">www.wago.com/216-106</a> |
|    | <b>Item no.: 216-107</b><br>Ferrule; Sleeve for 4 mm <sup>2</sup> / AWG 12; uninsulated; electro-tin plated                                                                            | <a href="http://www.wago.com/216-107">www.wago.com/216-107</a> |
|    | <b>Item no.: 216-108</b><br>Ferrule; Sleeve for 6 mm <sup>2</sup> / AWG 10; uninsulated; electro-tin plated; silver-colored                                                            | <a href="http://www.wago.com/216-108">www.wago.com/216-108</a> |
|    | <b>Item no.: 216-109</b><br>Ferrule; Sleeve for 10 mm <sup>2</sup> / AWG 8; uninsulated; electro-tin plated                                                                            | <a href="http://www.wago.com/216-109">www.wago.com/216-109</a> |
|    | <b>Item no.: 216-110</b><br>Ferrule; Sleeve for 16 mm <sup>2</sup> / AWG 6; uninsulated; electro-tin plated; brown metallic                                                            | <a href="http://www.wago.com/216-110">www.wago.com/216-110</a> |
|    | <b>Item no.: 216-123</b><br>Ferrule; Sleeve for 1 mm <sup>2</sup> / AWG 18; uninsulated; electro-tin plated; silver-colored                                                            | <a href="http://www.wago.com/216-123">www.wago.com/216-123</a> |
|  | <b>Item no.: 216-122</b><br>Ferrule; Sleeve for 0.75 mm <sup>2</sup> / AWG 20; uninsulated; electro-tin plated; silver-colored                                                         | <a href="http://www.wago.com/216-122">www.wago.com/216-122</a> |
|  | <b>Item no.: 216-124</b><br>Ferrule; Sleeve for 1.5 mm <sup>2</sup> / AWG 16; uninsulated; electro-tin plated                                                                          | <a href="http://www.wago.com/216-124">www.wago.com/216-124</a> |
|  | <b>Item no.: 216-142</b><br>Ferrule; Sleeve for 0.75 mm <sup>2</sup> / 18 AWG; uninsulated; electro-tin plated; electrolytic copper; gastight crimped; acc. to DIN 46228, Part 1/08.92 | <a href="http://www.wago.com/216-142">www.wago.com/216-142</a> |
|  | <b>Item no.: 216-132</b><br>Ferrule; Sleeve for 0.34 mm <sup>2</sup> / AWG 24; uninsulated; electro-tin plated                                                                         | <a href="http://www.wago.com/216-132">www.wago.com/216-132</a> |
|  | <b>Item no.: 216-121</b><br>Ferrule; Sleeve for 0.5 mm <sup>2</sup> / AWG 22; uninsulated; electro-tin plated; silver-colored                                                          | <a href="http://www.wago.com/216-121">www.wago.com/216-121</a> |
|  | <b>Item no.: 216-143</b><br>Ferrule; Sleeve for 1 mm <sup>2</sup> / AWG 18; uninsulated; electro-tin plated; electrolytic copper; gastight crimped; acc. to DIN 46228, Part 1/08.92    | <a href="http://www.wago.com/216-143">www.wago.com/216-143</a> |
|  | <b>Item no.: 216-131</b><br>Ferrule; Sleeve for 0.25 mm <sup>2</sup> / AWG 24; uninsulated; electro-tin plated; silver-colored                                                         | <a href="http://www.wago.com/216-131">www.wago.com/216-131</a> |
|  | <b>Item no.: 216-141</b><br>Ferrule; Sleeve for 0.5 mm <sup>2</sup> / 20 AWG; uninsulated; electro-tin plated; electrolytic copper; gastight crimped; acc. to DIN 46228, Part 1/08.92  | <a href="http://www.wago.com/216-141">www.wago.com/216-141</a> |

Subject to changes. Please also observe the further product documentation!

|                                                                                   |                                                                                                                                                                                                       |                                                                |
|-----------------------------------------------------------------------------------|-------------------------------------------------------------------------------------------------------------------------------------------------------------------------------------------------------|----------------------------------------------------------------|
|    | <b>Item no.: 216-152</b><br>Ferrule; Sleeve for 0.34 mm <sup>2</sup> / AWG 24; uninsulated; electro-tin plated                                                                                        | <a href="http://www.wago.com/216-152">www.wago.com/216-152</a> |
|    | <b>Item no.: 216-207</b><br>Ferrule; Sleeve for 4 mm <sup>2</sup> / AWG 12; insulated; electro-tin plated; gray                                                                                       | <a href="http://www.wago.com/216-207">www.wago.com/216-207</a> |
|    | <b>Item no.: 216-151</b><br>Ferrule; Sleeve for 0.25 mm <sup>2</sup> / AWG 24; uninsulated; electro-tin plated                                                                                        | <a href="http://www.wago.com/216-151">www.wago.com/216-151</a> |
|    | <b>Item no.: 216-209</b><br>Ferrule; Sleeve for 10 mm <sup>2</sup> / AWG 8; insulated; electro-tin plated; red                                                                                        | <a href="http://www.wago.com/216-209">www.wago.com/216-209</a> |
|    | <b>Item no.: 216-144</b><br>Ferrule; Sleeve for 1.5 mm <sup>2</sup> / AWG 16; uninsulated; electro-tin plated; electrolytic copper; gastight crimped; acc. to DIN 46228, Part 1/08.92; silver-colored | <a href="http://www.wago.com/216-144">www.wago.com/216-144</a> |
|    | <b>Item no.: 216-208</b><br>Ferrule; Sleeve for 6 mm <sup>2</sup> / AWG 10; insulated; electro-tin plated; electrolytic copper; gastight crimped; acc. to DIN 46228, Part 4/09.90; yellow             | <a href="http://www.wago.com/216-208">www.wago.com/216-208</a> |
|    | <b>Item no.: 216-223</b><br>Ferrule; Sleeve for 1 mm <sup>2</sup> / AWG 18; insulated; electro-tin plated; red                                                                                        | <a href="http://www.wago.com/216-223">www.wago.com/216-223</a> |
|    | <b>Item no.: 216-210</b><br>Ferrule; Sleeve for 16 mm <sup>2</sup> / AWG 6; insulated; electro-tin plated; electrolytic copper; gastight crimped; acc. to DIN 46228, Part 4/09.90; blue               | <a href="http://www.wago.com/216-210">www.wago.com/216-210</a> |
|    | <b>Item no.: 216-241</b><br>Ferrule; Sleeve for 0.5 mm <sup>2</sup> / 20 AWG; insulated; electro-tin plated; electrolytic copper; gastight crimped; acc. to DIN 46228, Part 4/09.90; white            | <a href="http://www.wago.com/216-241">www.wago.com/216-241</a> |
|    | <b>Item no.: 216-242</b><br>Ferrule; Sleeve for 0.75 mm <sup>2</sup> / 18 AWG; insulated; electro-tin plated; electrolytic copper; gastight crimped; acc. to DIN 46228, Part 4/09.90; gray            | <a href="http://www.wago.com/216-242">www.wago.com/216-242</a> |
|  | <b>Item no.: 216-222</b><br>Ferrule; Sleeve for 0.75 mm <sup>2</sup> / 18 AWG; insulated; electro-tin plated; gray                                                                                    | <a href="http://www.wago.com/216-222">www.wago.com/216-222</a> |
|  | <b>Item no.: 216-221</b><br>Ferrule; Sleeve for 0.5 mm <sup>2</sup> / 20 AWG; insulated; electro-tin plated; white                                                                                    | <a href="http://www.wago.com/216-221">www.wago.com/216-221</a> |
|  | <b>Item no.: 216-224</b><br>Ferrule; Sleeve for 1.5 mm <sup>2</sup> / AWG 16; insulated; electro-tin plated; black                                                                                    | <a href="http://www.wago.com/216-224">www.wago.com/216-224</a> |
|  | <b>Item no.: 216-243</b><br>Ferrule; Sleeve for 1 mm <sup>2</sup> / AWG 18; insulated; electro-tin plated; electrolytic copper; gastight crimped; acc. to DIN 46228, Part 4/09.90; red                | <a href="http://www.wago.com/216-243">www.wago.com/216-243</a> |
|  | <b>Item no.: 216-244</b><br>Ferrule; Sleeve for 1.5 mm <sup>2</sup> / AWG 16; insulated; electro-tin plated; electrolytic copper; gastight crimped; acc. to DIN 46228, Part 4/09.90; black            | <a href="http://www.wago.com/216-244">www.wago.com/216-244</a> |
|  | <b>Item no.: 216-263</b><br>Ferrule; Sleeve for 1 mm <sup>2</sup> / AWG 18; insulated; electro-tin plated; electrolytic copper; gastight crimped; acc. to DIN 46228, Part 4/09.90; red                | <a href="http://www.wago.com/216-263">www.wago.com/216-263</a> |
|  | <b>Item no.: 216-246</b><br>Ferrule; Sleeve for 2.5 mm <sup>2</sup> / AWG 14; insulated; electro-tin plated; electrolytic copper; gastight crimped; acc. to DIN 46228, Part 4/09.90; blue             | <a href="http://www.wago.com/216-246">www.wago.com/216-246</a> |

Subject to changes. Please also observe the further product documentation!

|                                                                                    |                                                                                                                                                                                            |                                                                |
|------------------------------------------------------------------------------------|--------------------------------------------------------------------------------------------------------------------------------------------------------------------------------------------|----------------------------------------------------------------|
|     | <b>Item no.: 216-266</b><br>Ferrule; Sleeve for 2.5 mm <sup>2</sup> / AWG 14; insulated; electro-tin plated; electrolytic copper; gastight crimped; acc. to DIN 46228, Part 4/09.90; blue  | <a href="http://www.wago.com/216-266">www.wago.com/216-266</a> |
|     | <b>Item no.: 216-264</b><br>Ferrule; Sleeve for 1.5 mm <sup>2</sup> / AWG 16; insulated; electro-tin plated; electrolytic copper; gastight crimped; acc. to DIN 46228, Part 4/09.90; black | <a href="http://www.wago.com/216-264">www.wago.com/216-264</a> |
|     | <b>Item no.: 216-284</b><br>Ferrule; Sleeve for 1.5 mm <sup>2</sup> / AWG 16; insulated; electro-tin plated; electrolytic copper; gastight crimped; acc. to DIN 46228, Part 4/09.90; black | <a href="http://www.wago.com/216-284">www.wago.com/216-284</a> |
|     | <b>Item no.: 216-286</b><br>Ferrule; Sleeve for 2.5 mm <sup>2</sup> / AWG 14; insulated; electro-tin plated; electrolytic copper; gastight crimped; acc. to DIN 46228, Part 4/09.90; blue  | <a href="http://www.wago.com/216-286">www.wago.com/216-286</a> |
|     | <b>Item no.: 216-287</b><br>Ferrule; Sleeve for 4 mm <sup>2</sup> / AWG 12; insulated; electro-tin plated; electrolytic copper; gastight crimped; acc. to DIN 46228, Part 4/09.90; gray    | <a href="http://www.wago.com/216-287">www.wago.com/216-287</a> |
|     | <b>Item no.: 216-262</b><br>Ferrule; Sleeve for 0.75 mm <sup>2</sup> / 18 AWG; insulated; electro-tin plated; electrolytic copper; gastight crimped; acc. to DIN 46228, Part 4/09.90; gray | <a href="http://www.wago.com/216-262">www.wago.com/216-262</a> |
|     | <b>Item no.: 216-288</b><br>Ferrule; Sleeve for 6 mm <sup>2</sup> / AWG 10; insulated; electro-tin plated; electrolytic copper; gastight crimped; acc. to DIN 46228, Part 4/09.90; yellow  | <a href="http://www.wago.com/216-288">www.wago.com/216-288</a> |
|     | <b>Item no.: 216-289</b><br>Ferrule; Sleeve for 10 mm <sup>2</sup> / AWG 8; insulated; electro-tin plated; electrolytic copper; gastight crimped; acc. to DIN 46228, Part 4/09.90; red     | <a href="http://www.wago.com/216-289">www.wago.com/216-289</a> |
|   | <b>Item no.: 216-321</b><br>Ferrule; Sleeve for 0.25 mm <sup>2</sup> / AWG 24; insulated; electro-tin plated; yellow                                                                       | <a href="http://www.wago.com/216-321">www.wago.com/216-321</a> |
|   | <b>Item no.: 216-322</b><br>Ferrule; Sleeve for 0.34 mm <sup>2</sup> / 22 AWG; insulated; electro-tin plated; light turquoise                                                              | <a href="http://www.wago.com/216-322">www.wago.com/216-322</a> |
|   | <b>Item no.: 216-267</b><br>Ferrule; Sleeve for 4 mm <sup>2</sup> / AWG 12; insulated; electro-tin plated; electrolytic copper; gastight crimped; acc. to DIN 46228, Part 4/09.90; gray    | <a href="http://www.wago.com/216-267">www.wago.com/216-267</a> |
| <b>Jumpers</b>                                                                     |                                                                                                                                                                                            |                                                                |
| Jumper                                                                             |                                                                                                                                                                                            |                                                                |
|  | <b>Item no.: 210-123</b><br>Wire commoning chain; insulated; blue                                                                                                                          | <a href="http://www.wago.com/210-123">www.wago.com/210-123</a> |
|   | <b>Item no.: 280-402</b><br>Jumper; insulated; gray                                                                                                                                        | <a href="http://www.wago.com/280-402">www.wago.com/280-402</a> |
|  | <b>Item no.: 210-103</b><br>Wire commoning chain; insulated; black                                                                                                                         | <a href="http://www.wago.com/210-103">www.wago.com/210-103</a> |
|   | <b>Item no.: 280-422</b><br>Jumper; insulated; yellow-green                                                                                                                                | <a href="http://www.wago.com/280-422">www.wago.com/280-422</a> |
|  | <b>Item no.: 709-110</b><br>Wire commoning chain; 2.5 mm <sup>2</sup> ; insulated; black                                                                                                   | <a href="http://www.wago.com/709-110">www.wago.com/709-110</a> |

Subject to changes. Please also observe the further product documentation!



**Item no.: 709-112**  
Wire commoning chain; 2.5 mm<sup>2</sup>; insulated; black

[www.wago.com/709-112](http://www.wago.com/709-112)



**Item no.: 709-111**  
Wire commoning chain; 2.5 mm<sup>2</sup>; insulated; black

[www.wago.com/709-111](http://www.wago.com/709-111)



**Item no.: 780-454**  
Staggered jumper; from 1 to 4; insulated; gray

[www.wago.com/780-454](http://www.wago.com/780-454)



**Item no.: 780-452**  
Staggered jumper; from 1 to 2; insulated; gray

[www.wago.com/780-452](http://www.wago.com/780-452)



**Item no.: 780-453**  
Staggered jumper; from 1 to 3; insulated; gray

[www.wago.com/780-453](http://www.wago.com/780-453)



**Item no.: 780-457**  
Staggered jumper; from 1 to 7; insulated; gray

[www.wago.com/780-457](http://www.wago.com/780-457)



**Item no.: 780-456**  
Staggered jumper; from 1 to 6; insulated; gray

[www.wago.com/780-456](http://www.wago.com/780-456)



**Item no.: 780-455**  
Staggered jumper; from 1 to 5; insulated; gray

[www.wago.com/780-455](http://www.wago.com/780-455)



**Item no.: 780-458**  
Staggered jumper; from 1 to 8; insulated; gray

[www.wago.com/780-458](http://www.wago.com/780-458)

### Testing and measuring

#### Testing accessories



**Item no.: 209-170**  
Test plug adapter; 8.3 mm wide; for 4 mm Ø test plugs; suitable for 1.5 mm<sup>2</sup> - 10 mm<sup>2</sup> tbs; gray

[www.wago.com/209-170](http://www.wago.com/209-170)



**Item no.: 210-136**  
Test plug; 2 mm Ø; with 500 mm cable; red

[www.wago.com/210-136](http://www.wago.com/210-136)



**Item no.: 281-407**  
Test plug; 6 mm wide; Nominal current 24 A; for 0.08 mm<sup>2</sup> - 2.5 mm<sup>2</sup>; 2,50 mm<sup>2</sup>; gray

[www.wago.com/281-407](http://www.wago.com/281-407)



**Item no.: 249-106**  
B-type test plug module; modular; 1,50 mm<sup>2</sup>; gray

[www.wago.com/249-106](http://www.wago.com/249-106)



**Item no.: 249-107**  
B-type spacer module; modular; e.g., for bridging commoned terminal blocks; gray

[www.wago.com/249-107](http://www.wago.com/249-107)



**Item no.: 280-418**  
Test plug module; modular; suitable for all WAGO 280 and 780 Series rail-mounted terminal blocks with jumper slots in the current bar; gray

[www.wago.com/280-418](http://www.wago.com/280-418)



**Item no.: 280-404**  
Test plug adapter; 5 mm wide; for test plug (2.3 mm Ø); suitable for 1.5 mm<sup>2</sup> - 4 mm<sup>2</sup> tbs; gray

[www.wago.com/280-404](http://www.wago.com/280-404)

Subject to changes. Please also observe the further product documentation!

|                                                                                    |                                                                                                                                                      |                                                                |
|------------------------------------------------------------------------------------|------------------------------------------------------------------------------------------------------------------------------------------------------|----------------------------------------------------------------|
|     | <b>Item no.: 280-419</b><br>Spacer module; modular; bridging commoned terminal blocks; gray                                                          | <a href="http://www.wago.com/280-419">www.wago.com/280-419</a> |
| <b>Carrier rail</b>                                                                |                                                                                                                                                      |                                                                |
| Mounting accessories                                                               |                                                                                                                                                      |                                                                |
|    | <b>Item no.: 210-197</b><br>Steel carrier rail; 35 x 15 mm; 1.5 mm thick; 2 m long; slotted; similar to EN 60715; silver-colored                     | <a href="http://www.wago.com/210-197">www.wago.com/210-197</a> |
|    | <b>Item no.: 210-198</b><br>Copper carrier rail; 35 x 15 mm; 2.3 mm thick; 2 m long; unslotted; according to EN 60715; copper-colored                | <a href="http://www.wago.com/210-198">www.wago.com/210-198</a> |
|    | <b>Item no.: 210-504</b><br>Steel carrier rail; 35 x 7.5 mm; 1 mm thick; 2 m long; slotted; galvanized; according to EN 60715; silver-colored        | <a href="http://www.wago.com/210-504">www.wago.com/210-504</a> |
|    | <b>Item no.: 210-505</b><br>Steel carrier rail; 35 x 7.5 mm; 1 mm thick; 2 m long; unslotted; galvanized; according to EN 60715; silver-colored      | <a href="http://www.wago.com/210-505">www.wago.com/210-505</a> |
|    | <b>Item no.: 210-506</b><br>Steel carrier rail; 35 x 15 mm; 1.5 mm thick; 2 m long; unslotted; galvanized; similar to EN 60715; silver-colored       | <a href="http://www.wago.com/210-506">www.wago.com/210-506</a> |
|    | <b>Item no.: 210-508</b><br>Steel carrier rail; 35 x 15 mm; 1.5 mm thick; 2 m long; slotted; galvanized; similar to EN 60715; silver-colored         | <a href="http://www.wago.com/210-508">www.wago.com/210-508</a> |
|   | <b>Item no.: 210-113</b><br>Steel carrier rail; 35 x 7.5 mm; 1 mm thick; 2 m long; unslotted; according to EN 60715; silver-colored                  | <a href="http://www.wago.com/210-113">www.wago.com/210-113</a> |
|  | <b>Item no.: 210-118</b><br>Steel carrier rail; 35 x 15 mm; 2.3 mm thick; 2 m long; unslotted; according to EN 60715; silver-colored                 | <a href="http://www.wago.com/210-118">www.wago.com/210-118</a> |
|  | <b>Item no.: 210-112</b><br>Steel carrier rail; 35 x 7.5 mm; 1 mm thick; 2 m long; slotted; according to EN 60715; "Hole width 25 mm; silver-colored | <a href="http://www.wago.com/210-112">www.wago.com/210-112</a> |
|  | <b>Item no.: 210-114</b><br>Steel carrier rail; 35 x 15 mm; 1.5 mm thick; 2 m long; unslotted; similar to EN 60715; silver-colored                   | <a href="http://www.wago.com/210-114">www.wago.com/210-114</a> |
|  | <b>Item no.: 210-115</b><br>Steel carrier rail; 35 x 7.5 mm; 1 mm thick; 2 m long; slotted; according to EN 60715; "Hole width 18 mm; silver-colored | <a href="http://www.wago.com/210-115">www.wago.com/210-115</a> |
|  | <b>Item no.: 210-196</b><br>Aluminum carrier rail; 35 x 8.2 mm; 1.6 mm thick; 2 m long; unslotted; similar to EN 60715; silver-colored               | <a href="http://www.wago.com/210-196">www.wago.com/210-196</a> |
| <b>Insulation stop</b>                                                             |                                                                                                                                                      |                                                                |
| Insulation stop                                                                    |                                                                                                                                                      |                                                                |
|  | <b>Item no.: 280-472</b><br>Insulation stop; 0.75 - 1 mm <sup>2</sup> ; 5 pieces/strip; black                                                        | <a href="http://www.wago.com/280-472">www.wago.com/280-472</a> |

Subject to changes. Please also observe the further product documentation!





**Item no.: 280-470**  
Insulation stop; 0.08 - 0.2 mm<sup>2</sup> "s" (0.14 mm<sup>2</sup> "f-st"); 5 pieces/strip; white

[www.wago.com/280-470](http://www.wago.com/280-470)



**Item no.: 280-471**  
Insulation stop; 0.25 - 0.5 mm<sup>2</sup>; 5 pieces/strip; light gray

[www.wago.com/280-471](http://www.wago.com/280-471)

**Marking accessories**

Marker



**Item no.: 2009-115/000-002**  
WMB-Inline; for Smart Printer; 1500 pieces on roll; stretchable 5 - 5.2 mm; plain; snap-on type; yellow

[www.wago.com/2009-115/000-002](http://www.wago.com/2009-115/000-002)



**Item no.: 2009-115/000-007**  
WMB-Inline; for Smart Printer; 1500 pieces on roll; stretchable 5 - 5.2 mm; plain; snap-on type; gray

[www.wago.com/2009-115/000-007](http://www.wago.com/2009-115/000-007)



**Item no.: 2009-115/000-017**  
WMB-Inline; for Smart Printer; 1500 pieces on roll; stretchable 5 - 5.2 mm; plain; snap-on type; light green

[www.wago.com/2009-115/000-017](http://www.wago.com/2009-115/000-017)



**Item no.: 2009-115/000-023**  
WMB-Inline; for Smart Printer; 1500 pieces on roll; stretchable 5 - 5.2 mm; plain; snap-on type; green

[www.wago.com/2009-115/000-023](http://www.wago.com/2009-115/000-023)



**Item no.: 2009-115/000-024**  
WMB-Inline; for Smart Printer; 1500 pieces on roll; stretchable 5 - 5.2 mm; plain; snap-on type; violet

[www.wago.com/2009-115/000-024](http://www.wago.com/2009-115/000-024)



**Item no.: 2009-145/000-006**  
Mini-WSB Inline; for Smart Printer; 1700 pieces on roll; stretchable 5 - 5.2 mm; plain; snap-on type; blue

[www.wago.com/2009-145/000-006](http://www.wago.com/2009-145/000-006)



**Item no.: 2009-145**  
Mini-WSB Inline; for Smart Printer; 1700 pieces on roll; stretchable 5 - 5.2 mm; plain; snap-on type; white

[www.wago.com/2009-145](http://www.wago.com/2009-145)



**Item no.: 2009-145/000-002**  
Mini-WSB Inline; for Smart Printer; 1700 pieces on roll; stretchable 5 - 5.2 mm; plain; snap-on type; yellow

[www.wago.com/2009-145/000-002](http://www.wago.com/2009-145/000-002)



**Item no.: 2009-145/000-007**  
Mini-WSB Inline; for Smart Printer; 1700 pieces on roll; stretchable 5 - 5.2 mm; plain; snap-on type; gray

[www.wago.com/2009-145/000-007](http://www.wago.com/2009-145/000-007)



**Item no.: 2009-145/000-005**  
Mini-WSB Inline; for Smart Printer; 1700 pieces on roll; stretchable 5 - 5.2 mm; plain; snap-on type; red













[www.wago.com/2009-145/000-005](http://www.wago.com/2009-145/000-005)



**Item no.: 2009-145/000-012**  
Mini-WSB Inline; for Smart Printer; 1700 pieces on roll; stretchable 5 - 5.2 mm; plain; snap-on type; orange

[www.wago.com/2009-145/000-012](http://www.wago.com/2009-145/000-012)

Subject to changes. Please also observe the further product documentation!

|                                                                                    |                                                                                                                                                   |                                                                                  |
|------------------------------------------------------------------------------------|---------------------------------------------------------------------------------------------------------------------------------------------------|----------------------------------------------------------------------------------|
|    | <b>Item no.: 2009-145/000-023</b><br>Mini-WSB Inline; for Smart Printer; 1700 pieces on roll; stretchable 5 - 5.2 mm; plain; snap-on type; green  | <a href="http://www.wago.com/2009-145/000-023">www.wago.com/2009-145/000-023</a> |
|    | <b>Item no.: 2009-145/000-024</b><br>Mini-WSB Inline; for Smart Printer; 1700 pieces on roll; stretchable 5 - 5.2 mm; plain; snap-on type; violet | <a href="http://www.wago.com/2009-145/000-024">www.wago.com/2009-145/000-024</a> |
|    | <b>Item no.: 2009-115</b><br>WMB-Inline; for Smart Printer; 1500 pieces on roll; stretchable 5 - 5.2 mm; plain; snap-on type; white               | <a href="http://www.wago.com/2009-115">www.wago.com/2009-115</a>                 |
|    | <b>Item no.: 248-501/000-006</b><br>Mini-WSB marking card; as card; not stretchable; plain; snap-on type; blue                                    | <a href="http://www.wago.com/248-501/000-006">www.wago.com/248-501/000-006</a>   |
|    | <b>Item no.: 248-501/000-007</b><br>Mini-WSB marking card; as card; not stretchable; plain; snap-on type; gray                                    | <a href="http://www.wago.com/248-501/000-007">www.wago.com/248-501/000-007</a>   |
|    | <b>Item no.: 248-501/000-002</b><br>Mini-WSB marking card; as card; not stretchable; plain; snap-on type; yellow                                  | <a href="http://www.wago.com/248-501/000-002">www.wago.com/248-501/000-002</a>   |
|   | <b>Item no.: 248-501/000-012</b><br>Mini-WSB marking card; as card; not stretchable; plain; snap-on type; orange                                  | <a href="http://www.wago.com/248-501/000-012">www.wago.com/248-501/000-012</a>   |
|  | <b>Item no.: 248-501</b><br>Mini-WSB marking card; as card; not stretchable; plain; snap-on type; white                                           | <a href="http://www.wago.com/248-501">www.wago.com/248-501</a>                   |
|  | <b>Item no.: 248-501/000-017</b><br>Mini-WSB marking card; as card; not stretchable; plain; snap-on type; light green                             | <a href="http://www.wago.com/248-501/000-017">www.wago.com/248-501/000-017</a>   |
|  | <b>Item no.: 248-501/000-005</b><br>Mini-WSB marking card; as card; not stretchable; plain; snap-on type; red                                     | <a href="http://www.wago.com/248-501/000-005">www.wago.com/248-501/000-005</a>   |
|  | <b>Item no.: 248-501/000-024</b><br>Mini-WSB marking card; as card; not stretchable; plain; snap-on type; violet                                  | <a href="http://www.wago.com/248-501/000-024">www.wago.com/248-501/000-024</a>   |
|  | <b>Item no.: 248-501/000-023</b><br>Mini-WSB marking card; as card; not stretchable; plain; snap-on type; green                                   | <a href="http://www.wago.com/248-501/000-023">www.wago.com/248-501/000-023</a>   |

Subject to changes. Please also observe the further product documentation!



**Item no.:** 793-5501/000-007

WMB marking card; as card; for terminal block width 5 - 17.5 mm; stretchable 5 - 5.2 mm; plain; snap-on type; gray [www.wago.com/793-5501/000-007](http://www.wago.com/793-5501/000-007)



**Item no.:** 793-5501/000-012

WMB marking card; as card; for terminal block width 5 - 17.5 mm; stretchable 5 - 5.2 mm; plain; snap-on type; orange [www.wago.com/793-5501/000-012](http://www.wago.com/793-5501/000-012)



**Item no.:** 793-5501/000-017

WMB marking card; as card; for terminal block width 5 - 17.5 mm; stretchable 5 - 5.2 mm; plain; snap-on type; light green [www.wago.com/793-5501/000-017](http://www.wago.com/793-5501/000-017)



**Item no.:** 793-5501/000-023

WMB marking card; as card; for terminal block width 5 - 17.5 mm; stretchable 5 - 5.2 mm; plain; snap-on type; green [www.wago.com/793-5501/000-023](http://www.wago.com/793-5501/000-023)



**Item no.:** 793-5501/000-024

WMB marking card; as card; for terminal block width 5 - 17.5 mm; stretchable 5 - 5.2 mm; plain; snap-on type; violet [www.wago.com/793-5501/000-024](http://www.wago.com/793-5501/000-024)



**Item no.:** 793-501/000-002

WMB marking card; as card; not stretchable; plain; snap-on type; yellow [www.wago.com/793-501/000-002](http://www.wago.com/793-501/000-002)



**Item no.:** 793-501/000-007

WMB marking card; as card; not stretchable; plain; snap-on type; gray [www.wago.com/793-501/000-007](http://www.wago.com/793-501/000-007)



**Item no.:** 793-501/000-017

WMB marking card; as card; not stretchable; plain; snap-on type; light green [www.wago.com/793-501/000-017](http://www.wago.com/793-501/000-017)

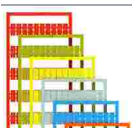

**Item no.:** 793-501/000-012

WMB marking card; as card; not stretchable; plain; snap-on type; orange [www.wago.com/793-501/000-012](http://www.wago.com/793-501/000-012)

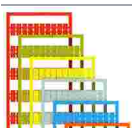

**Item no.:** 793-501/000-023

WMB marking card; as card; not stretchable; plain; snap-on type; green [www.wago.com/793-501/000-023](http://www.wago.com/793-501/000-023)

Subject to changes. Please also observe the further product documentation!

WAGO GmbH & Co. KG

Hansastr. 27

32423 Minden

Phone: +49571 887-0 | Fax: +49571 887-169

Email: [info.de@wago.com](mailto:info.de@wago.com) | Web: [www.wago.com](http://www.wago.com)

Do you have any questions about our products?

We are always happy to take your call at +49 (571) 887-44222.



**Item no.: 793-501/000-006**  
WMB marking card; as card; not stretchable; plain; snap-on type; blue

[www.wago.com/793-501/000-006](http://www.wago.com/793-501/000-006)



**Item no.: 793-501/000-005**  
WMB marking card; as card; not stretchable; plain; snap-on type; red

[www.wago.com/793-501/000-005](http://www.wago.com/793-501/000-005)



**Item no.: 793-501**  
WMB marking card; as card; not stretchable; plain; snap-on type; white

[www.wago.com/793-501](http://www.wago.com/793-501)



**Item no.: 793-501/000-024**  
WMB marking card; as card; not stretchable; plain; snap-on type; violet

[www.wago.com/793-501/000-024](http://www.wago.com/793-501/000-024)



**Item no.: 793-5501/000-005**  
WMB marking card; as card; for terminal block width 5 - 17.5 mm; stretchable 5 - 5.2 mm; plain; snap-on type; red

[www.wago.com/793-5501/000-005](http://www.wago.com/793-5501/000-005)



**Item no.: 793-5501/000-002**  
WMB marking card; as card; for terminal block width 5 - 17.5 mm; stretchable 5 - 5.2 mm; plain; snap-on type; yellow

[www.wago.com/793-5501/000-002](http://www.wago.com/793-5501/000-002)



**Item no.: 793-5501/000-006**  
WMB marking card; as card; for terminal block width 5 - 17.5 mm; stretchable 5 - 5.2 mm; plain; snap-on type; blue

[www.wago.com/793-5501/000-006](http://www.wago.com/793-5501/000-006)



**Item no.: 793-5501**  
WMB marking card; as card; for terminal block width 5 - 17.5 mm; stretchable 5 - 5.2 mm; plain; snap-on type; white

[www.wago.com/793-5501](http://www.wago.com/793-5501)



**Item no.: 2009-115/000-012**  
WMB-Inline; for Smart Printer; 1500 pieces on roll; stretchable 5 - 5.2 mm; plain; snap-on type; orange

[www.wago.com/2009-115/000-012](http://www.wago.com/2009-115/000-012)



**Item no.: 2009-115/000-006**  
WMB-Inline; for Smart Printer; 1500 pieces on roll; stretchable 5 - 5.2 mm; plain; snap-on type; blue

[www.wago.com/2009-115/000-006](http://www.wago.com/2009-115/000-006)

#### Group marker carrier



**Item no.: 249-105**  
Group marker carrier; gray

[www.wago.com/249-105](http://www.wago.com/249-105)

#### Protective warning marker

Cover

Subject to changes. Please also observe the further product documentation!



**Item no.: 280-415**

Protective warning marker; for 5 terminal blocks; with high-voltage symbol, black; yellow

[www.wago.com/280-415](http://www.wago.com/280-415)

## Mounting

Cover carrier



**Item no.: 709-167**

Cover carrier; Type 1; incl. fixing/retaining screws and knurled nut; suitable for 279 to 282 and 880 Series rail-mounted terminal blocks; suitable for 264 Series miniature rail-mounted terminal blocks; suitable for 270 Series sensor and actuator terminal blocks; gray

[www.wago.com/709-167](http://www.wago.com/709-167)

Cover



**Item no.: 709-153**

Cover; Type 1; suitable for cover carrier, type 1; 1 m long; transparent

[www.wago.com/709-153](http://www.wago.com/709-153)

Mounting accessories



**Item no.: 209-106**

Mounting carrier; for isolated mounting on DIN 35 rails; gray

[www.wago.com/209-106](http://www.wago.com/209-106)



**Item no.: 249-116**

Screwless end stop; 6 mm wide; for DIN-rail 35 x 15 and 35 x 7.5; gray

[www.wago.com/249-116](http://www.wago.com/249-116)

## Push-in type wire jumper

Jumper



**Item no.: 249-123**

Push-in type wire jumper; 0.75 mm<sup>2</sup>; insulated; 180 mm long; black

[www.wago.com/249-123](http://www.wago.com/249-123)



**Item no.: 249-126**

Push-in type wire jumper; 0.75 mm<sup>2</sup>; insulated; 110 mm long; black

[www.wago.com/249-126](http://www.wago.com/249-126)



**Item no.: 249-127**

Push-in type wire jumper; 0.75 mm<sup>2</sup>; insulated; 250 mm long; black

[www.wago.com/249-127](http://www.wago.com/249-127)



**Item no.: 249-125**

Push-in type wire jumper; insulated; 60 mm long; black

[www.wago.com/249-125](http://www.wago.com/249-125)

## End plate

End plate



**Item no.: 880-345**

Separator plate; 2 mm thick; oversized; gray

[www.wago.com/880-345](http://www.wago.com/880-345)



**Item no.: 880-347**

Separator plate; 2 mm thick; oversized; orange

[www.wago.com/880-347](http://www.wago.com/880-347)

## Downloads

### Documentation

#### Additional Information

Technical Section

Subject to changes. Please also observe the further product documentation!

WAGO GmbH & Co. KG

Hansastr. 27

32423 Minden

Phone: +49571 887-0 | Fax: +49571 887-169

Email: [info.de@wago.com](mailto:info.de@wago.com) | Web: [www.wago.com](http://www.wago.com)

Do you have any questions about our products?

We are always happy to take your call at +49 (571) 887-44222.



Technical section

Technical explanations

pdf  
2.2 MB

[Download](#)

### CAD/CAE-Data

#### CAD data

2D/3D Models 880-837

[URL](#)

[Download](#)

#### CAE data

WSCAD Universe 880-837

[URL](#)

[Download](#)

ZUKEN Portal 880-837

[URL](#)

[Download](#)

EPLAN Data Portal 880-837

[URL](#)

[Download](#)

### Environmental Product Compliance

#### Compliance Search

Environmental Product Compliance 880-837

[URL](#)

[Download](#)

4-conductor ground terminal block; 4 mm<sup>2</sup>; side and center marking; for DIN-rail 35 x 15 and 35 x 7.5; CAGE CLAMP®; 4,00 mm<sup>2</sup>; green-yellow

### Installation Notes

Subject to changes. Please also observe the further product documentation!

WAGO GmbH & Co. KG

Hansastr. 27

32423 Minden

Phone: +49571 887-0 | Fax: +49571 887-169

Email: [info.de@wago.com](mailto:info.de@wago.com) | Web: [www.wago.com](http://www.wago.com)

Do you have any questions about our products?

We are always happy to take your call at +49 (571) 887-44222.

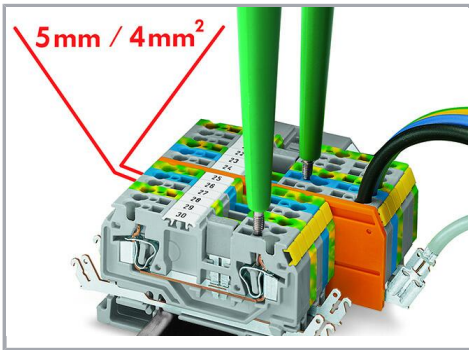

## Features

- 2-, 3- and 4-conductor terminal blocks, just 5 mm wide
- Conductor cross-sections up to 4 mm<sup>2</sup> (per VDE 0281) or 12 AWG with ferrule (Item No. 216-206) 2.5 mm<sup>2</sup> rubber-insulated conductors with outer diameter up to 4.4 mm
- Shield contact via 6.3 (2 x 2.8) mm solder/crimp quick disconnect terminal
- Test plug, red, 2 mm Ø
- WMB markers
- Mini-WSB markers, on both sides
- Commoning with WAGO jumper systems

## Testing

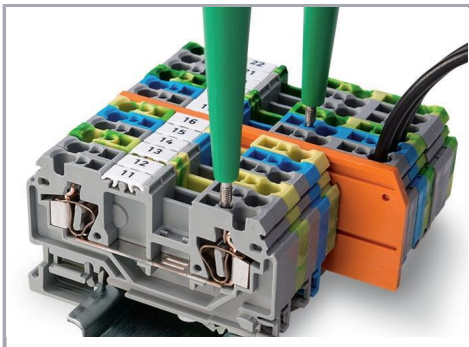

880 Series Terminal Blocks have an additional test slot for voltage tester.

## Product family

Subject to changes. Please also observe the further product documentation!

WAGO GmbH & Co. KG  
Hansastr. 27  
32423 Minden  
Phone: +49571 887-0 | Fax: +49571 887-169  
Email: [info.de@wago.com](mailto:info.de@wago.com) | Web: [www.wago.com](http://www.wago.com)

Do you have any questions about our products?  
We are always happy to take your call at +49 (571) 887-44222.



Classic

EPSITRON® CLASSIC POWER: The Robust Power Supply – with Integrated TopBoost (Optional)

[Show all products from the family](#)

Subject to changes. Please also observe the further product documentation!

---

WAGO GmbH & Co. KG  
Hansastr. 27  
32423 Minden  
Phone: +49571 887-0 | Fax: +49571 887-169  
Email: [info.de@wago.com](mailto:info.de@wago.com) | Web: [www.wago.com](http://www.wago.com)

Do you have any questions about our products?  
We are always happy to take your call at +49 (571) 887-44222.